

Ergebnis: **299.9** (283)
 Serien: 100.3 98.4 101.2
 Zähler: 15 13 2 0 0 0 0 0 0 0
 Innenzehner: 13
 weiteste: 693 (15), 608 (13), 483 (2)
 beste Teiler 50.4 (20.) 65.8 (6.) 70.1 (27.)
 Trefferlage 0.56 mm rechts, 0.49 mm tief
 Streuwert 1.95, horizontal: 2.38, vertikal: 1.41

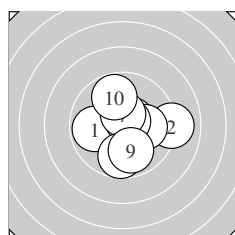

Serie 1:
 9.8 ← 9.0 → 10.3 * 10.5 * 10.1 →
 10.7 * 10.5 * 9.7 ↓ 9.9 ↓ 9.8 ↑
 beste Teiler 65.8 (6.) 102.9 (4.) 109.0 (7.)
 Trefferlage 0.71 mm rechts, 0.18 mm tief
 Streuwert 1.83, horizontal: 1.99, vertikal: 1.66

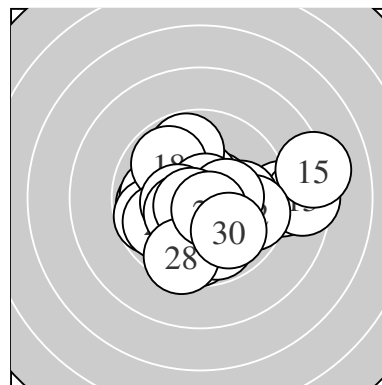
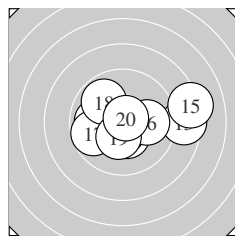

Serie 2:
 10.4 * 9.9 ← 8.5 → 10.6 * 8.2 →
 10.0 → 9.7 ← 9.9 ↘ 10.4 * 10.8 *
 beste Teiler 50.4 (20.) 91.0 (14.) 142.9 (11.)
 Trefferlage 0.83 mm rechts, 0.06 mm tief
 Streuwert 2.50, horizontal: 3.33, vertikal: 1.20

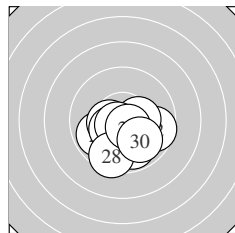

Serie 3:
 9.9 ↙ 9.7 → 10.4 * 10.4 * 9.8 ↓
 10.3 * 10.7 * 9.5 ↓ 10.6 * 9.9 ↘
 beste Teiler 70.1 (27.) 86.8 (29.) 134.3 (23.)
 Trefferlage 0.14 mm rechts, 1.24 mm tief
 Streuwert 1.44, horizontal: 1.70, vertikal: 1.12

Unterschrift des Schützen

Meyton Elektronik

Ergebnis: **308.8** (297)
 Serien: 102.7 102.7 103.4
 Zähler: 27 3 0 0 0 0 0 0 0 0
 Innenzehner: 17
 weiteste: 295 (1), 286 (7), 251 (20)
 beste Teiler 7.2 (15.) 36.3 (14.) 79.6 (5.)
 Trefferlage 0.05 mm links, 0.50 mm tief
 Streuwert 1.24, horizontal: 0.85, vertikal: 1.53

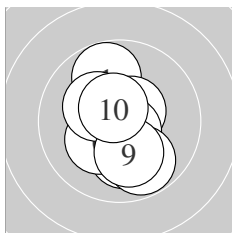
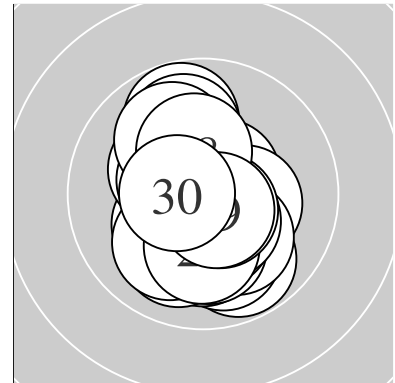

Serie 1:
 9.8 ↗ 10.5 * 10.6 * 10.1 ↓ 10.6 *
 10.3 * 9.8 ↘ 10.3 * 10.1 ↓ 10.6 *
 beste Teiler 79.6 (5.) 95.2 (10.) 99.9 (3.)
 Trefferlage 0.07 mm links, 0.42 mm tief
 Streuwert 1.37, horizontal: 0.93, vertikal: 1.70

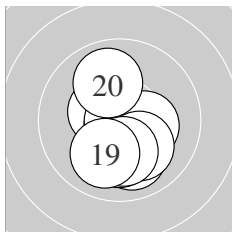

Serie 2:
 10.0 ↓ 10.1 ↓ 10.5 * 10.8 * 10.9 *
 10.3 * 10.1 ↘ 10.1 ↓ 10.0 ↙ 9.9 ↗
 beste Teiler 7.2 (15.) 36.3 (14.) 123.8 (13.)
 Trefferlage 0.09 mm rechts, 0.80 mm tief
 Streuwert 1.26, horizontal: 0.91, vertikal: 1.52

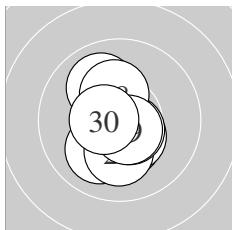

Serie 3:
 10.0 ↘ 10.4 * 10.4 * 10.1 ↓ 10.6 *
 10.0 ↗ 10.5 * 10.3 * 10.6 * 10.5 *
 beste Teiler 81.6 (29.) 91.2 (25.) 101.0 (30.)
 Trefferlage 0.18 mm links, 0.27 mm tief
 Streuwert 1.17, horizontal: 0.78, vertikal: 1.45

Unterschrift des Schützen

Ergebnis: **282.8** (272)
 Serien: 94.9 91.9 96.0
 Zähler: 8 16 6 0 0 0 0 0 0 0
 Innenzehner: 4
 weiteste: 729 (9), 729 (14), 676 (16)
 beste Teiler 76.9 (28.) 105.5 (8.) 153.0 (24.)
 Trefferlage 0.73 mm links, 1.32 mm tief
 Streuwert 2.78, horizontal: 3.30, vertikal: 2.13

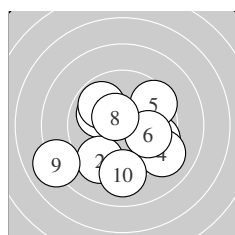
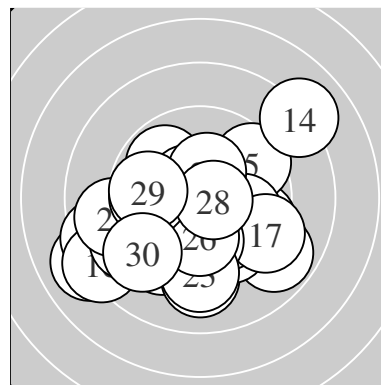

Serie 1:
 10.0 ↘ 9.4 ↙ 9.6 → 9.1 ↘ 9.5 ↗
 9.9 → 9.8 ↘ 10.5 * 8.0 ↙ 9.1 ↓
 beste Teiler 105.5 (8.) 241.0 (1.) 258.7 (6.)
 Trefferlage 0.09 mm links, 1.06 mm tief
 Streuwert 2.85, horizontal: 3.22, vertikal: 2.43

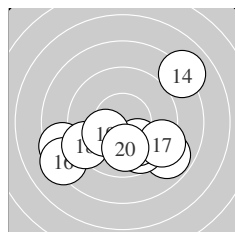

Serie 2:
 8.8 ↘ 9.7 ↘ 8.5 ↙ 8.0 ↗ 10.0 ↘
 8.2 ↙ 9.2 → 9.3 ↙ 10.2 * 10.0 ↓
 beste Teiler 192.2 (19.) 238.8 (15.) 245.2 (20.)
 Trefferlage 0.04 mm rechts, 1.68 mm tief
 Streuwert 3.31, horizontal: 4.07, vertikal: 2.32

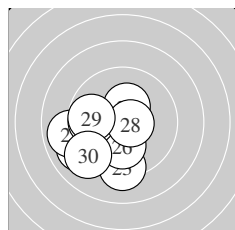

Serie 3:
 9.0 ↙ 9.2 ← 9.2 ↓ 10.3 * 8.9 ←
 10.1 ↓ 9.8 ← 10.6 * 9.8 ← 9.1 ↙
 beste Teiler 76.9 (28.) 153.0 (24.) 222.0 (26.)
 Trefferlage 2.15 mm links, 1.24 mm tief
 Streuwert 1.99, horizontal: 2.19, vertikal: 1.77

Unterschrift des Schützen

Meyton Elektronik

Ergebnis: **311.6** (300)
 Serien: 103.6 104.3 103.7
 Zähler: 30 0 0 0 0 0 0 0 0 0
 Innenzehner: 26
 weiteste: 236 (30), 218 (19), 216 (16)
 beste Teiler 9.0 (17.) 55.9 (3.) 57.2 (26.)
 Trefferlage 0.02 mm rechts, 0.15 mm hoch
 Streuwert 1.07, horizontal: 1.13, vertikal: 1.02

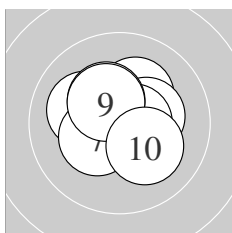
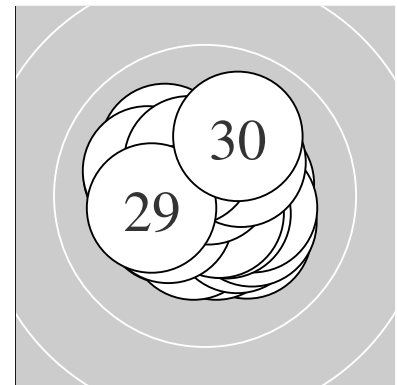

Serie 1:
 10.2 * 10.3 * 10.7 * 10.1 ↖ 10.5 *
 10.6 * 10.3 * 10.3 * 10.4 * 10.2 *
 beste Teiler 55.9 (3.) 80.0 (6.) 102.6 (5.)
 Trefferlage 0.11 mm rechts, 0.22 mm hoch
 Streuwert 1.11, horizontal: 1.23, vertikal: 0.98

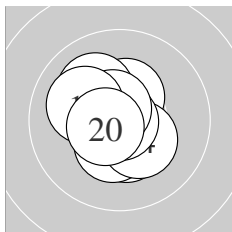

Serie 2:
 10.4 * 10.4 * 10.4 * 10.3 * 10.5 *
 10.1 ↘ 10.9 * 10.6 * 10.1 ↖ 10.6 *
 beste Teiler 9.0 (17.) 78.0 (18.) 91.2 (20.)
 Trefferlage 0.38 mm links, 0.09 mm hoch
 Streuwert 1.02, horizontal: 0.91, vertikal: 1.12

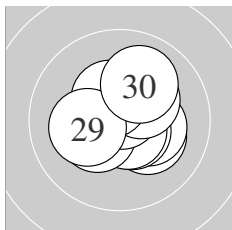

Serie 3:
 10.2 * 10.3 * 10.6 * 10.6 * 10.4 *
 10.7 * 10.3 * 10.4 * 10.2 * 10.0 ↗
 beste Teiler 57.2 (26.) 77.4 (24.) 95.7 (23.)
 Trefferlage 0.33 mm rechts, 0.12 mm hoch
 Streuwert 1.13, horizontal: 1.22, vertikal: 1.04

Unterschrift des Schützen

Ergebnis: **314.8** (299)
 Serien: 104.9 104.7 105.2
 Zähler: 29 1 0 0 0 0 0 0 0 0
 Innenzehner: 26
 weiteste: 255 (15), 244 (10), 227 (24)
 beste Teiler 29.4 (21.) 32.5 (6.) 40.3 (19.)
 Trefferlage 0.29 mm links, 0.24 mm hoch
 Streuwert 0.89, horizontal: 0.74, vertikal: 1.02

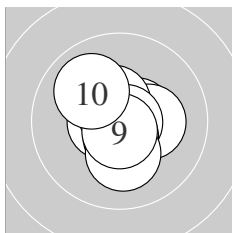
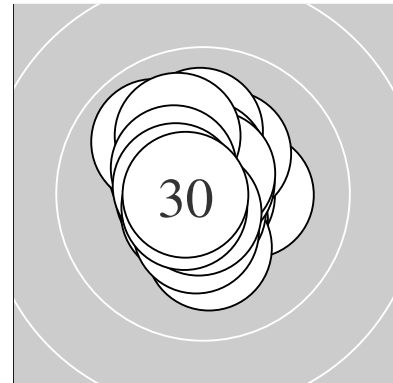

Serie 1:
 10.5 * 10.6 * 10.3 * 10.7 * 10.5 *
 10.8 * 10.6 * 10.2 * 10.7 * 10.0 ↘
 beste Teiler 32.5 (6.) 59.0 (9.) 63.9 (4.)
 Trefferlage 0.00 mm , 0.01 mm hoch
 Streuwert 0.99, horizontal: 0.93, vertikal: 1.04

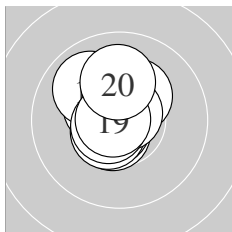

Serie 2:
 10.3 * 10.4 * 10.6 * 10.7 * 9.9 ↘
 10.6 * 10.7 * 10.7 * 10.8 * 10.0 ↑
 beste Teiler 40.3 (19.) 52.2 (17.) 60.1 (14.)
 Trefferlage 0.43 mm links, 0.45 mm hoch
 Streuwert 0.92, horizontal: 0.73, vertikal: 1.09

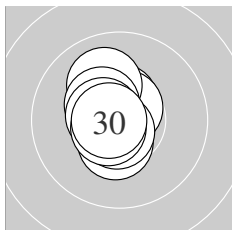

Serie 3:
 10.8 * 10.5 * 10.6 * 10.0 ↘ 10.4 *
 10.4 * 10.5 * 10.7 * 10.6 * 10.7 *
 beste Teiler 29.4 (21.) 63.0 (30.) 68.8 (28.)
 Trefferlage 0.45 mm links, 0.26 mm hoch
 Streuwert 0.77, horizontal: 0.46, vertikal: 0.98

 Unterschrift des Schützen

Ergebnis: **303.7** (290)
 Serien: 99.5 102.6 101.6
 Zähler: 20 10 0 0 0 0 0 0 0 0
 Innenzehner: 14
 weiteste: 408 (28), 404 (8), 371 (19)
 beste Teiler 19.2 (17.) 20.5 (4.) 31.3 (23.)
 Trefferlage 0.61 mm links, 0.07 mm hoch
 Streuwert 1.61, horizontal: 1.87, vertikal: 1.31

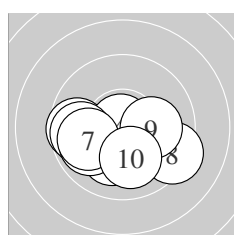
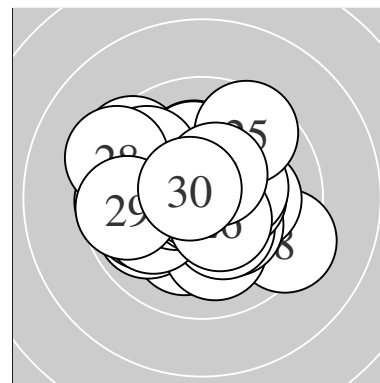

Serie 1:
 10.0 ← 10.1 ↓ 9.6 ← 10.9 * 9.7 ←
 9.9 ← 9.9 ← 9.3 ↘ 10.1 → 10.0 ↓
 beste Teiler 20.5 (4.) 207.0 (9.) 211.1 (2.)
 Trefferlage 0.79 mm links, 0.92 mm tief
 Streuwert 1.74, horizontal: 2.31, vertikal: 0.85

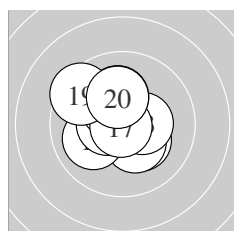

Serie 2:
 10.3 * 10.3 * 10.4 * 10.0 ← 10.5 *
 10.4 * 10.9 * 10.1 ↑ 9.5 ↘ 10.2 *
 beste Teiler 19.2 (17.) 110.0 (15.) 142.0 (13.)
 Trefferlage 0.42 mm links, 0.37 mm hoch
 Streuwert 1.39, horizontal: 1.43, vertikal: 1.36

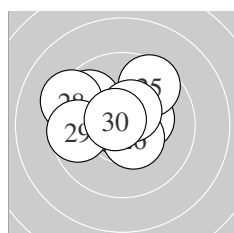

Serie 3:
 10.3 * 10.5 * 10.8 * 9.8 ↘ 9.6 ↗
 10.5 * 10.5 * 9.3 ↘ 9.6 ← 10.7 *
 beste Teiler 31.3 (23.) 66.4 (30.) 117.8 (27.)
 Trefferlage 0.63 mm links, 0.76 mm hoch
 Streuwert 1.59, horizontal: 1.95, vertikal: 1.11

Unterschrift des Schützen

Ergebnis: **305.8** (293)
 Serien: 100.6 102.8 102.4
 Zähler: 23 7 0 0 0 0 0 0 0 0
 Innenzehner: 16
 weiteste: 442 (2), 383 (9), 352 (6)
 beste Teiler 30.0 (11.) 65.3 (7.) 79.5 (26.)
 Trefferlage 0.24 mm links, 0.14 mm tief
 Streuwert 1.51, horizontal: 1.66, vertikal: 1.35

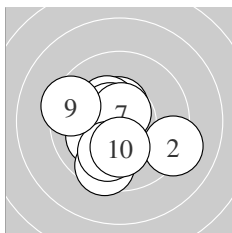
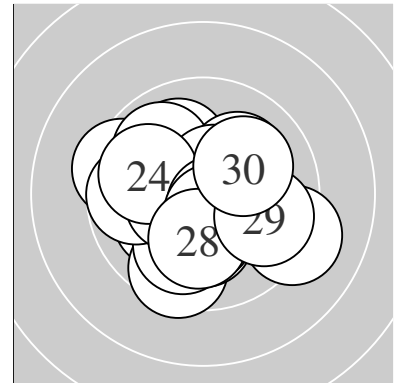

Serie 1:
 10.5 * 9.2 ↘ 10.4 * 10.6 * 10.1 ↙
 9.5 ↓ 10.7 * 10.0 ↓ 9.4 ← 10.2 *
 beste Teiler 65.3 (7.) 95.5 (4.) 109.2 (1.)
 Trefferlage 0.50 mm links, 0.58 mm tief
 Streuwert 1.82, horizontal: 1.94, vertikal: 1.70

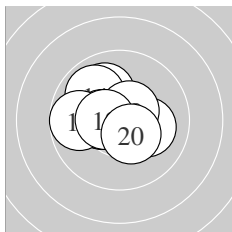

Serie 2:
 10.8 * 10.0 ↖ 10.4 * 9.9 ↖ 10.4 *
 10.1 → 9.7 ← 10.6 * 10.5 * 10.4 *
 beste Teiler 30.0 (11.) 100.4 (18.) 109.1 (19.)
 Trefferlage 0.60 mm links, 0.35 mm hoch
 Streuwert 1.25, horizontal: 1.48, vertikal: 0.97

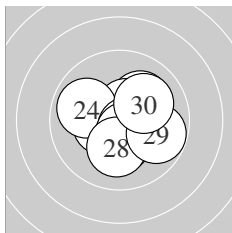

Serie 3:
 10.1 ↗ 10.6 * 10.4 * 9.9 ↖ 10.3 *
 10.6 * 10.5 * 10.1 ↓ 9.8 → 10.1 ↗
 beste Teiler 79.5 (26.) 99.3 (22.) 101.1 (27.)
 Trefferlage 0.37 mm rechts, 0.20 mm tief
 Streuwert 1.38, horizontal: 1.51, vertikal: 1.25

Unterschrift des Schützen

Meyton Elektronik

Ergebnis: **304.9** (292)
 Serien: 99.6 102.5 102.8
 Zähler: 22 8 0 0 0 0 0 0 0 0
 Innenzehner: 15
 weiteste: 388 (1), 369 (10), 321 (20)
 beste Teiler 21.9 (25.) 24.1 (14.) 56.2 (13.)
 Trefferlage 0.39 mm rechts, 0.12 mm tief
 Streuwert 1.56, horizontal: 1.63, vertikal: 1.49

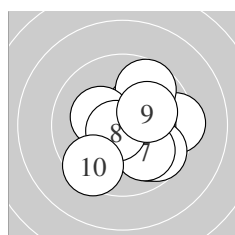
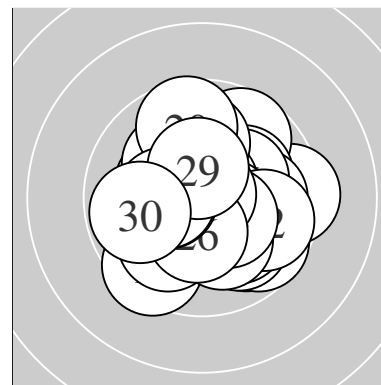

Serie 1:
 9.4 → 9.9 ↘ 10.3 * 9.7 ↗ 9.7 ↘
 10.3 * 10.0 ↘ 10.7 * 10.1 ↗ 9.5 ↙
 beste Teiler 63.7 (8.) 173.4 (6.) 174.6 (3.)
 Trefferlage 1.03 mm rechts, 0.33 mm tief
 Streuwert 1.84, horizontal: 1.89, vertikal: 1.78

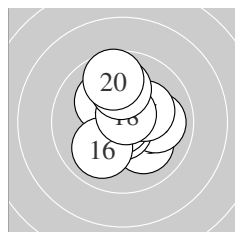

Serie 2:
 10.1 ↘ 10.0 → 10.7 * 10.9 * 10.2 *
 10.0 ↙ 10.2 * 10.7 * 10.0 ↑ 9.7 ↑
 beste Teiler 24.1 (14.) 56.2 (13.) 63.1 (18.)
 Trefferlage 0.19 mm rechts, 0.43 mm hoch
 Streuwert 1.47, horizontal: 1.30, vertikal: 1.62

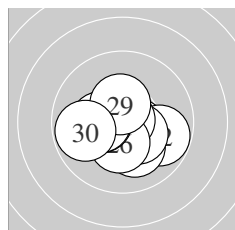

Serie 3:
 10.5 * 9.8 → 10.1 ↘ 10.4 * 10.9 *
 10.3 * 10.3 * 10.3 * 10.4 * 9.8 ←
 beste Teiler 21.9 (25.) 115.8 (21.) 132.2 (29.)
 Trefferlage 0.04 mm links, 0.48 mm tief
 Streuwert 1.30, horizontal: 1.61, vertikal: 0.90

Unterschrift des Schützen

Meyton Elektronik

Ergebnis: **308.6** (295)
 Serien: 101.5 104.5 102.6
 Zähler: 25 5 0 0 0 0 0 0 0 0
 Innenzehner: 20
 weiteste: 316 (10), 290 (8), 281 (4)
 beste Teiler 35.0 (29.) 45.2 (12.) 70.8 (14.)
 Trefferlage 0.40 mm rechts, 0.19 mm hoch
 Streuwert 1.28, horizontal: 1.28, vertikal: 1.28

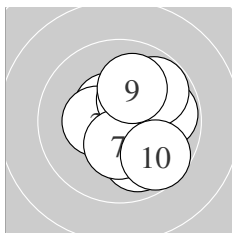
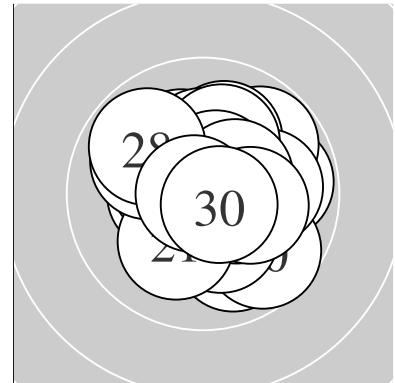

Serie 1:
 10.6 * 10.5 * 10.4 * 9.8 → 10.3 *
 9.9 ↘ 10.4 * 9.8 ↗ 10.1 ↑ 9.7 ↘
 beste Teiler 83.7 (1.) 110.1 (2.) 145.0 (3.)
 Trefferlage 0.79 mm rechts, 0.15 mm hoch
 Streuwert 1.49, horizontal: 1.36, vertikal: 1.61

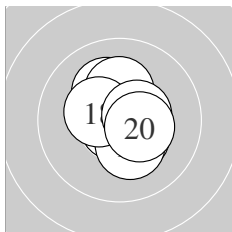

Serie 2:
 10.2 * 10.8 * 10.4 * 10.7 * 10.6 *
 10.2 * 10.3 * 10.4 * 10.5 * 10.4 *
 beste Teiler 45.2 (12.) 70.8 (14.) 81.8 (15.)
 Trefferlage 0.25 mm rechts, 0.00 mm
 Streuwert 1.00, horizontal: 0.86, vertikal: 1.12

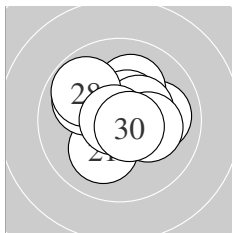

Serie 3:
 10.1 ↙ 10.0 → 10.0 ↖ 10.1 ↑ 10.5 *
 10.4 * 10.2 * 9.8 ↘ 10.8 * 10.7 *
 beste Teiler 35.0 (29.) 74.3 (30.) 108.2 (25.)
 Trefferlage 0.15 mm rechts, 0.42 mm hoch
 Streuwert 1.37, horizontal: 1.55, vertikal: 1.16

Unterschrift des Schützen

Ergebnis: **305.0** (294)
 Serien: 101.1 102.0 101.9
 Zähler: 24 6 0 0 0 0 0 0 0 0
 Innenzehner: 17
 weiteste: 408 (23), 390 (18), 328 (7)
 beste Teiler 43.6 (14.) 48.7 (13.) 83.6 (21.)
 Trefferlage 0.84 mm links, 0.44 mm hoch
 Streuwert 1.40, horizontal: 1.50, vertikal: 1.29

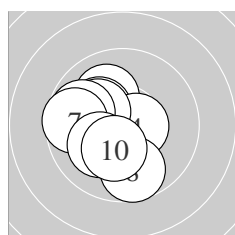
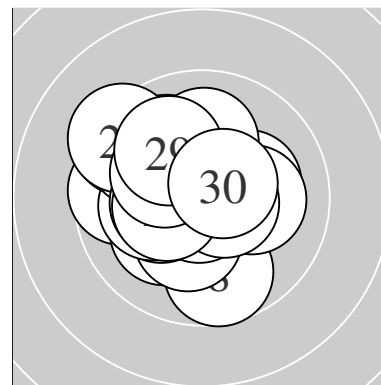

Serie 1:
 10.5 * 10.1 ↖ 10.2 * 10.6 * 10.2 *
 9.8 ↙ 9.6 ← 9.7 ↓ 10.1 ↗ 10.3 *
 beste Teiler 92.1 (4.) 124.0 (1.) 169.2 (10.)
 Trefferlage 1.16 mm links, 0.19 mm tief
 Streuwert 1.43, horizontal: 1.33, vertikal: 1.52

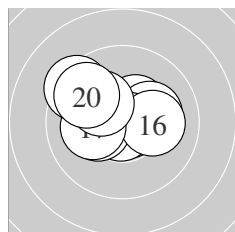

Serie 2:
 10.4 * 10.2 * 10.8 * 10.8 * 10.3 *
 10.1 → 10.1 ← 9.4 ↘ 10.2 * 9.7 ↖
 beste Teiler 43.6 (14.) 48.7 (13.) 133.2 (11.)
 Trefferlage 0.56 mm links, 0.55 mm hoch
 Streuwert 1.48, horizontal: 1.83, vertikal: 1.01

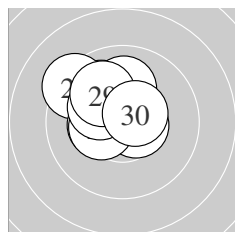

Serie 3:
 10.6 * 10.0 ↖ 9.3 ↘ 10.0 ↑ 10.6 *
 10.3 * 10.4 * 10.2 * 10.0 ↘ 10.5 *
 beste Teiler 83.6 (21.) 94.3 (25.) 104.2 (30.)
 Trefferlage 0.80 mm links, 0.98 mm hoch
 Streuwert 1.25, horizontal: 1.39, vertikal: 1.10

Unterschrift des Schützen

Meyton Elektronik

Ergebnis: **309.6** (296)
 Serien: 101.1 103.8 104.7
 Zähler: 26 4 0 0 0 0 0 0 0 0
 Innenzehner: 20
 weiteste: 342 (5), 321 (4), 276 (18)
 beste Teiler 25.0 (21.) 41.5 (12.) 51.6 (20.)
 Trefferlage 0.66 mm rechts, 0.05 mm hoch
 Streuwert 1.18, horizontal: 1.34, vertikal: 1.00

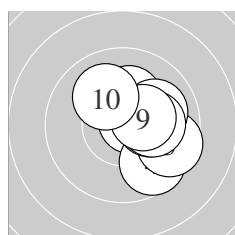
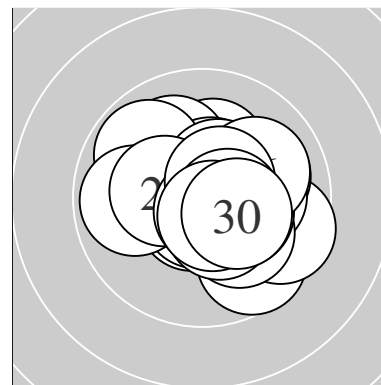

Serie 1:
 10.2 * 10.1 → 10.7 * 9.7 ↘ 9.6 ↘
 10.2 * 10.0 → 10.1 → 10.4 * 10.1 ↘
 beste Teiler 66.6 (3.) 147.1 (9.) 184.2 (6.)
 Trefferlage 1.45 mm rechts, 0.23 mm hoch
 Streuwert 1.27, horizontal: 1.21, vertikal: 1.31

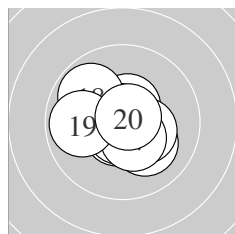

Serie 2:
 10.5 * 10.8 * 10.6 * 10.1 ↘ 10.3 *
 10.7 * 10.4 * 9.8 ↘ 9.9 ← 10.7 *
 beste Teiler 41.5 (12.) 51.6 (20.) 65.1 (16.)
 Trefferlage 0.12 mm links, 0.10 mm tief
 Streuwert 1.20, horizontal: 1.39, vertikal: 0.98

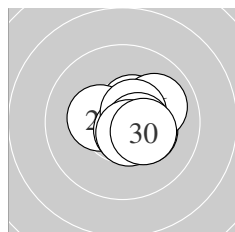

Serie 3:
 10.9 * 10.5 * 10.3 * 10.3 * 10.7 *
 10.0 → 10.6 * 10.5 * 10.6 * 10.3 *
 beste Teiler 25.0 (21.) 60.8 (25.) 84.7 (29.)
 Trefferlage 0.65 mm rechts, 0.04 mm hoch
 Streuwert 0.86, horizontal: 1.00, vertikal: 0.68

Unterschrift des Schützen

Meyton Elektronik

Ergebnis: **304.3** (291)
 Serien: 101.3 101.2 101.8
 Zähler: 21 9 0 0 0 0 0 0 0 0
 Innenzehner: 17
 weiteste: 464 (13), 443 (11), 371 (24)
 beste Teiler 33.1 (4.) 47.0 (27.) 59.0 (19.)
 Trefferlage 0.85 mm links, 0.20 mm tief
 Streuwert 1.52, horizontal: 1.65, vertikal: 1.38

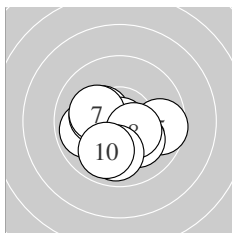
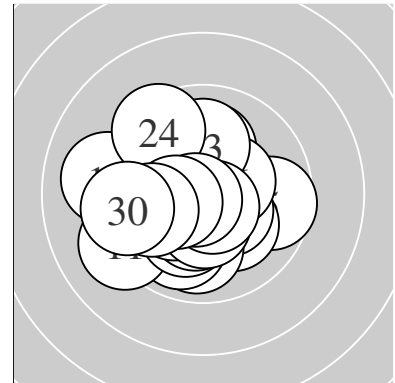

Serie 1:
 9.9 ← 10.3 * 10.2 * 10.8 * 9.6 →
 10.1 ↘ 10.2 * 10.4 * 9.9 ↓ 9.9 ↓
 beste Teiler 33.1 (4.) 136.7 (8.) 154.6 (2.)
 Trefferlage 0.32 mm links, 0.69 mm tief
 Streuwert 1.50, horizontal: 1.80, vertikal: 1.13

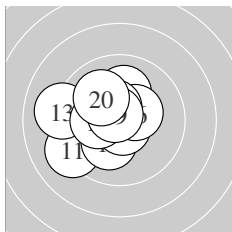

Serie 2:
 9.2 ↙ 10.2 * 9.1 ← 10.1 ↑ 10.7 *
 10.4 * 10.3 * 10.5 * 10.7 * 10.0 ↘
 beste Teiler 59.0 (19.) 62.2 (15.) 111.8 (18.)
 Trefferlage 1.14 mm links, 0.20 mm hoch
 Streuwert 1.64, horizontal: 1.83, vertikal: 1.43

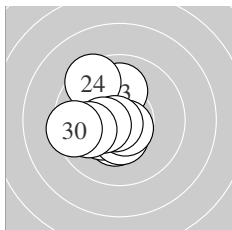

Serie 3:
 10.4 * 10.3 * 10.0 ↑ 9.5 ↘ 10.4 *
 10.6 * 10.8 * 10.4 * 9.9 ← 9.5 ←
 beste Teiler 47.0 (27.) 78.0 (26.) 133.2 (25.)
 Trefferlage 1.11 mm links, 0.11 mm tief
 Streuwert 1.43, horizontal: 1.32, vertikal: 1.53

Unterschrift des Schützen

Ergebnis: **307.2** (294)
 Serien: 101.4 103.1 102.7
 Zähler: 24 6 0 0 0 0 0 0 0 0
 Innenzehner: 19
 weiteste: 378 (18), 322 (29), 309 (13)
 beste Teiler 16.1 (27.) 79.4 (22.) 83.1 (16.)
 Trefferlage 0.30 mm links, 0.37 mm tief
 Streuwert 1.37, horizontal: 1.56, vertikal: 1.15

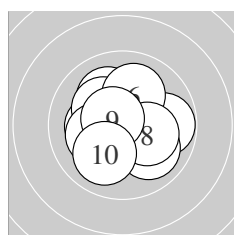
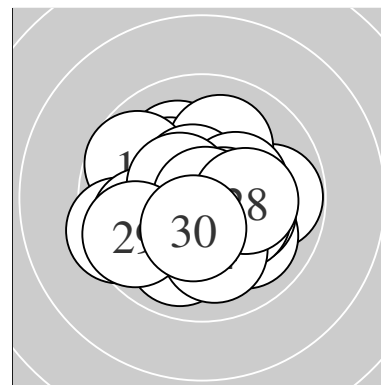

Serie 1:
 10.2 * 10.1 ↖ 10.2 * 9.8 → 10.0 ↘
 10.1 ↗ 10.2 * 10.2 * 10.6 * 10.0 ↙
 beste Teiler 85.1 (9.) 180.1 (3.) 184.7 (8.)
 Trefferlage 0.08 mm links, 0.07 mm hoch
 Streuwert 1.56, horizontal: 1.73, vertikal: 1.37

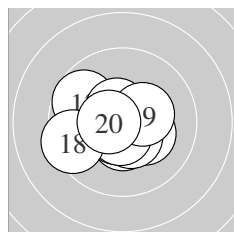

Serie 2:
 10.5 * 10.3 * 9.7 ↘ 10.5 * 10.6 *
 10.6 * 10.6 * 9.4 ← 10.3 * 10.6 *
 beste Teiler 83.1 (16.) 85.4 (15.) 96.1 (17.)
 Trefferlage 0.46 mm links, 0.31 mm tief
 Streuwert 1.34, horizontal: 1.62, vertikal: 0.97

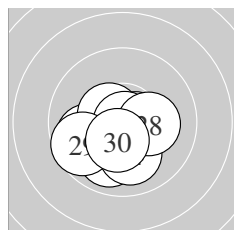

Serie 3:
 10.6 * 10.6 * 9.9 ↓ 10.0 ↓ 9.9 ←
 10.5 * 10.9 * 10.2 * 9.7 ← 10.4 *
 beste Teiler 16.1 (27.) 79.4 (22.) 90.5 (21.)
 Trefferlage 0.36 mm links, 0.87 mm tief
 Streuwert 1.24, horizontal: 1.46, vertikal: 0.96

Unterschrift des Schützen

Meyton Elektronik

Ergebnis: **309.0** (298)
 Serien: 104.6 102.3 102.1
 Zähler: 28 2 0 0 0 0 0 0 0 0
 Innenzehner: 20
 weiteste: 307 (14), 280 (16), 244 (23)
 beste Teiler 2.0 (7.) 59.0 (18.) 64.0 (12.)
 Trefferlage 0.55 mm rechts, 0.08 mm tief
 Streuwert 1.22, horizontal: 1.33, vertikal: 1.09

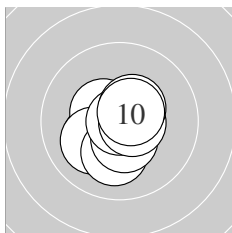
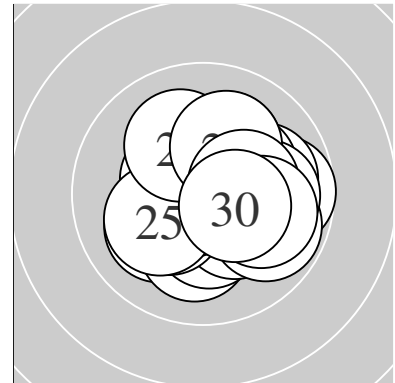

Serie 1:
 10.6 * 10.2 * 10.5 * 10.1 ↙ 10.1 ↓
 10.5 * 10.9 * 10.6 * 10.5 * 10.6 *
 beste Teiler 2.0 (7.) 85.7 (8.) 88.0 (1.)
 Trefferlage 0.19 mm links, 0.46 mm tief
 Streuwert 0.98, horizontal: 0.97, vertikal: 0.99

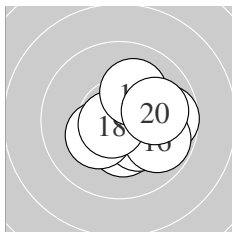

Serie 2:
 10.3 * 10.7 * 10.4 * 9.7 → 10.3 *
 9.8 ↘ 10.3 * 10.7 * 10.1 ↗ 10.0 →
 beste Teiler 59.0 (18.) 64.0 (12.) 129.0 (13.)
 Trefferlage 1.02 mm rechts, 0.34 mm tief
 Streuwert 1.22, horizontal: 1.39, vertikal: 1.02

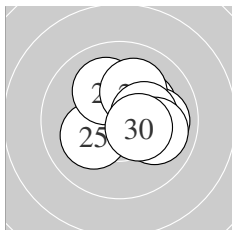

Serie 3:
 10.2 * 10.4 * 10.0 → 10.4 * 10.2 *
 10.1 ↖ 10.1 ↗ 10.3 * 10.0 → 10.4 *
 beste Teiler 136.7 (30.) 147.2 (24.) 150.2 (22.)
 Trefferlage 0.83 mm rechts, 0.54 mm hoch
 Streuwert 1.23, horizontal: 1.37, vertikal: 1.09

Unterschrift des Schützen

Ergebnis: **306.2** (294)
 Serien: 101.5 102.8 101.9
 Zähler: 24 6 0 0 0 0 0 0 0 0
 Innenzehner: 18
 weiteste: 418 (1), 366 (21), 347 (4)
 beste Teiler 55.5 (30.) 64.0 (10.) 89.4 (14.)
 Trefferlage 0.36 mm links, 0.05 mm tief
 Streuwert 1.48, horizontal: 1.64, vertikal: 1.30

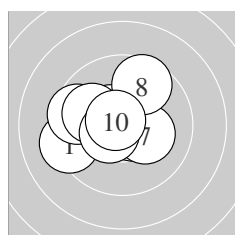
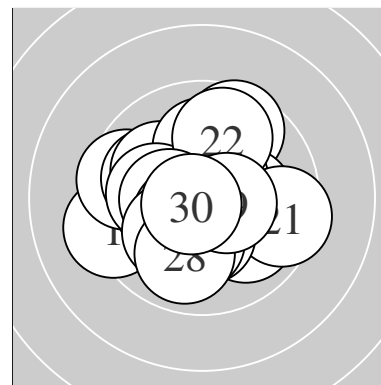

Serie 1:
 9.3 ← 10.5 * 10.5 * 9.6 ↖ 10.6 *
 10.0 ↖ 10.2 * 9.6 ↑ 10.5 * 10.7 *
 beste Teiler 64.0 (10.) 89.5 (5.) 113.2 (2.)
 Trefferlage 0.92 mm links, 0.31 mm hoch
 Streuwert 1.59, horizontal: 1.90, vertikal: 1.21

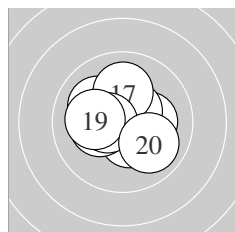

Serie 2:
 10.2 * 10.1 ↖ 10.4 * 10.6 * 10.3 *
 10.5 * 10.1 ↑ 10.5 * 10.1 ← 10.0 ↘
 beste Teiler 89.4 (14.) 110.6 (16.) 112.1 (18.)
 Trefferlage 0.22 mm links, 0.21 mm hoch
 Streuwert 1.31, horizontal: 1.48, vertikal: 1.11

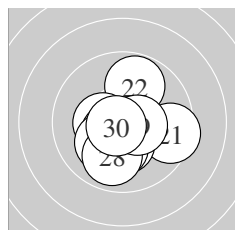

Serie 3:
 9.5 → 9.8 ↑ 10.3 * 10.4 * 10.5 *
 10.2 * 10.1 ↙ 9.9 ↓ 10.5 * 10.7 *
 beste Teiler 55.5 (30.) 112.3 (29.) 120.9 (25.)
 Trefferlage 0.04 mm rechts, 0.70 mm tief
 Streuwert 1.47, horizontal: 1.51, vertikal: 1.43

Unterschrift des Schützen

Meyton Elektronik

Ergebnis: **306.0** (292)
 Serien: 102.3 101.6 102.1
 Zähler: 22 8 0 0 0 0 0 0 0 0
 Innenzehner: 15
 weiteste: 383 (11), 377 (25), 317 (10)
 beste Teiler 31.0 (12.) 62.0 (5.) 77.2 (19.)
 Trefferlage 0.28 mm rechts, 0.57 mm tief
 Streuwert 1.45, horizontal: 1.70, vertikal: 1.15

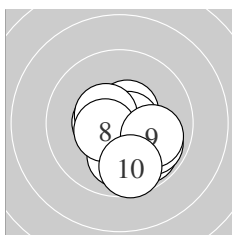
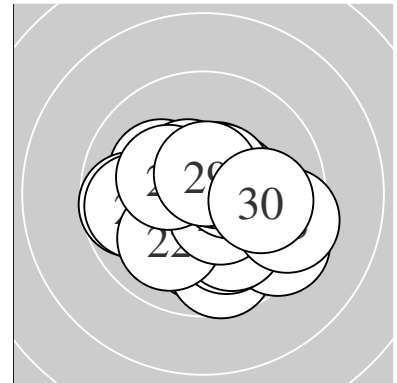

Serie 1:
 10.5 * 10.0 ↓ 10.6 * 9.9 ↘ 10.7 *
 10.5 * 9.9 ↘ 10.5 * 10.0 → 9.7 ↓
 beste Teiler 62.0 (5.) 99.0 (3.) 113.8 (6.)
 Trefferlage 0.51 mm rechts, 0.88 mm tief
 Streuwert 1.32, horizontal: 1.34, vertikal: 1.31

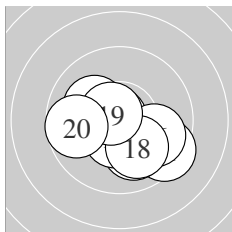

Serie 2:
 9.4 ↘ 10.8 * 10.0 ↓ 10.6 * 10.1 ↖
 9.9 → 10.5 * 10.0 ↓ 10.6 * 9.7 ←
 beste Teiler 31.0 (12.) 77.2 (19.) 91.7 (14.)
 Trefferlage 0.09 mm rechts, 0.75 mm tief
 Streuwert 1.55, horizontal: 1.91, vertikal: 1.08

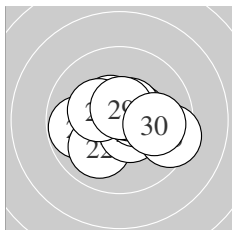

Serie 3:
 9.8 ← 10.0 ↙ 10.5 * 10.5 * 9.4 →
 10.5 * 10.3 * 10.5 * 10.6 * 10.0 →
 beste Teiler 87.1 (29.) 103.3 (28.) 108.2 (23.)
 Trefferlage 0.24 mm rechts, 0.10 mm tief
 Streuwert 1.53, horizontal: 1.94, vertikal: 0.98

Unterschrift des Schützen

Ergebnis: **312.7** (300)
 Serien: 103.9 104.0 104.8
 Zähler: 30 0 0 0 0 0 0 0 0 0
 Innenzehner: 24
 weiteste: 235 (13), 228 (6), 222 (29)
 beste Teiler 12.0 (28.) 28.2 (15.) 47.1 (24.)
 Trefferlage 0.14 mm rechts, 0.42 mm tief
 Streuwert 0.98, horizontal: 1.05, vertikal: 0.91

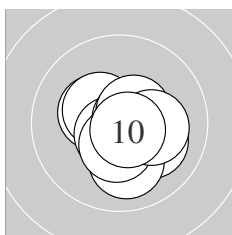
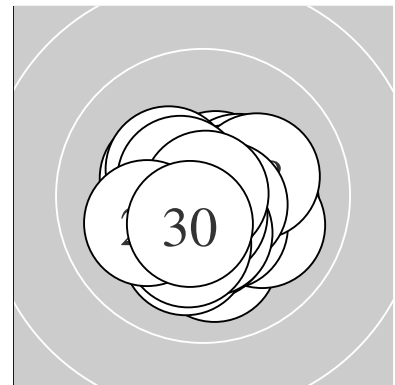

Serie 1:
 10.3 * 10.1 ↘ 10.4 * 10.6 * 10.7 *
 10.0 ↓ 10.5 * 10.4 * 10.2 * 10.7 *
 beste Teiler 62.4 (10.) 65.9 (5.) 79.6 (4.)
 Trefferlage 0.28 mm rechts, 0.36 mm tief
 Streuwert 1.05, horizontal: 1.12, vertikal: 0.98

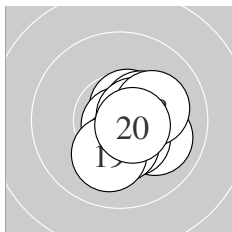

Serie 2:
 10.6 * 10.4 * 10.0 ↘ 10.4 * 10.8 *
 10.4 * 10.6 * 10.1 → 10.1 ↓ 10.6 *
 beste Teiler 28.2 (15.) 83.0 (20.) 90.0 (11.)
 Trefferlage 0.76 mm rechts, 0.37 mm tief
 Streuwert 0.92, horizontal: 0.85, vertikal: 0.99

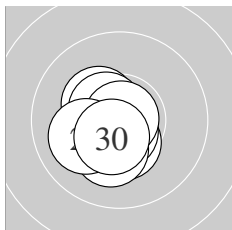

Serie 3:
 10.4 * 10.3 * 10.7 * 10.8 * 10.4 *
 10.5 * 10.2 * 10.9 * 10.1 ← 10.5 *
 beste Teiler 12.0 (28.) 47.1 (24.) 68.1 (23.)
 Trefferlage 0.61 mm links, 0.52 mm tief
 Streuwert 0.78, horizontal: 0.71, vertikal: 0.85

Unterschrift des Schützen

Ergebnis: **310.5** (297)
 Serien: 103.7 102.4 104.4
 Zähler: 27 3 0 0 0 0 0 0 0 0
 Innenzehner: 21
 weiteste: 328 (23), 288 (3), 261 (7)
 beste Teiler 17.0 (28.) 23.0 (27.) 50.1 (24.)
 Trefferlage 0.34 mm rechts, 0.04 mm tief
 Streuwert 1.19, horizontal: 1.18, vertikal: 1.21

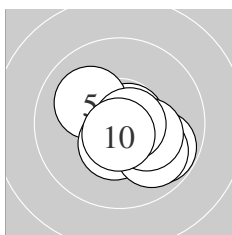
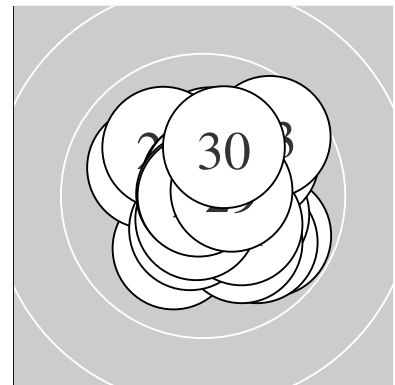

Serie 1:
 10.7 * 10.6 * 9.8 ↘ 10.6 * 10.1 ↖
 10.4 * 9.9 ↘ 10.2 * 10.7 * 10.7 *
 beste Teiler 57.5 (1.) 61.4 (9.) 70.3 (10.)
 Trefferlage 0.63 mm rechts, 0.55 mm tief
 Streuwert 1.07, horizontal: 1.23, vertikal: 0.88

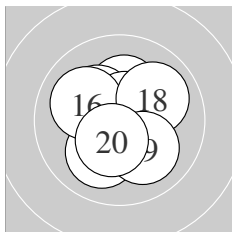

Serie 2:
 10.1 ↙ 10.4 * 10.2 * 10.2 * 10.6 *
 10.0 ↖ 10.4 * 10.0 ↗ 10.1 ↘ 10.4 *
 beste Teiler 82.3 (15.) 128.8 (17.) 132.0 (20.)
 Trefferlage 0.04 mm rechts, 0.11 mm tief
 Streuwert 1.36, horizontal: 1.27, vertikal: 1.43

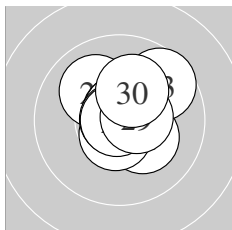

Serie 3:
 10.2 * 10.0 ↖ 9.6 ↗ 10.8 * 10.6 *
 10.7 * 10.9 * 10.9 * 10.5 * 10.2 *
 beste Teiler 17.0 (28.) 23.0 (27.) 50.1 (24.)
 Trefferlage 0.36 mm rechts, 0.52 mm hoch
 Streuwert 1.10, horizontal: 1.09, vertikal: 1.10

Unterschrift des Schützen

Ergebnis: **312.9** (298)
 Serien: 104.0 103.2 105.7
 Zähler: 28 2 0 0 0 0 0 0 0 0
 Innenzehner: 26
 weiteste: 293 (15), 263 (12), 227 (13)
 beste Teiler 47.4 (21.) 49.0 (28.) 54.4 (24.)
 Trefferlage 0.13 mm rechts, 0.34 mm hoch
 Streuwert 1.01, horizontal: 1.04, vertikal: 0.97

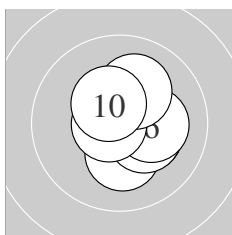
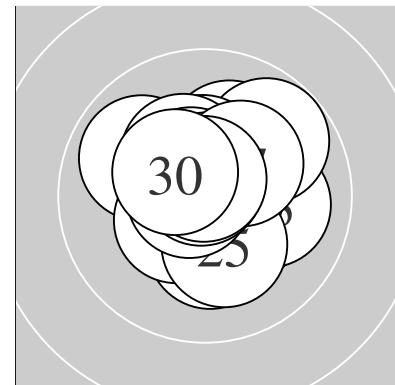

Serie 1:
 10.5 * 10.3 * 10.7 * 10.2 * 10.3 *
 10.2 * 10.6 * 10.7 * 10.1 ↗ 10.4 *
 beste Teiler 62.5 (3.) 63.2 (8.) 83.2 (7.)
 Trefferlage 0.49 mm rechts, 0.11 mm tief
 Streuwert 1.01, horizontal: 0.94, vertikal: 1.08

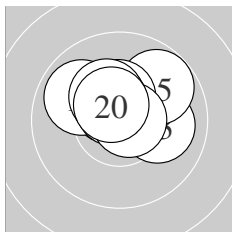

Serie 2:
 10.5 * 9.9 ↖ 10.0 → 10.6 * 9.8 ↗
 10.4 * 10.7 * 10.5 * 10.3 * 10.5 *
 beste Teiler 56.0 (17.) 77.8 (14.) 104.7 (20.)
 Trefferlage 0.01 mm links, 0.93 mm hoch
 Streuwert 1.08, horizontal: 1.37, vertikal: 0.67

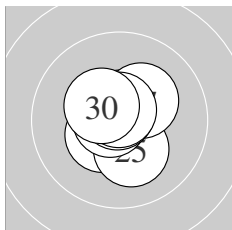

Serie 3:
 10.8 * 10.7 * 10.4 * 10.7 * 10.2 *
 10.7 * 10.3 * 10.8 * 10.7 * 10.4 *
 beste Teiler 47.4 (21.) 49.0 (28.) 54.4 (24.)
 Trefferlage 0.07 mm links, 0.22 mm hoch
 Streuwert 0.80, horizontal: 0.71, vertikal: 0.88

Unterschrift des Schützen

Ergebnis: **314.2** (299)
 Serien: 104.2 104.5 105.5
 Zähler: 29 1 0 0 0 0 0 0 0 0
 Innenzehner: 28
 weiteste: 255 (20), 239 (18), 198 (9)
 beste Teiler 22.0 (25.) 26.9 (15.) 27.2 (10.)
 Trefferlage 0.08 mm rechts, 0.03 mm hoch
 Streuwert 0.96, horizontal: 0.90, vertikal: 1.01

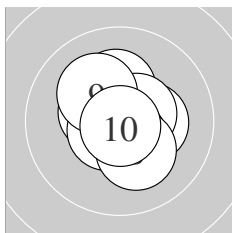
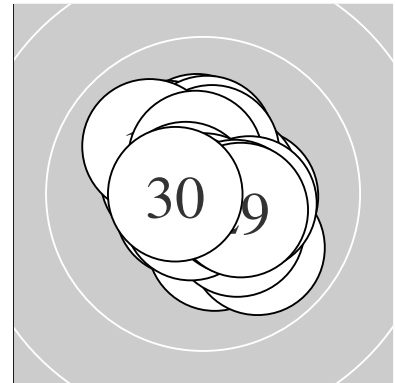

Serie 1:
 10.3 * 10.5 * 10.2 * 10.5 * 10.4 *
 10.5 * 10.6 * 10.2 * 10.2 * 10.8 *
 beste Teiler 27.2 (10.) 84.4 (7.) 101.7 (2.)
 Trefferlage 0.02 mm rechts, 0.17 mm hoch
 Streuwert 1.01, horizontal: 0.95, vertikal: 1.08

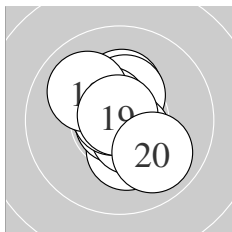

Serie 2:
 10.3 * 10.4 * 10.3 * 10.6 * 10.8 *
 10.6 * 10.8 * 10.0 ↘ 10.8 * 9.9 ↘
 beste Teiler 26.9 (15.) 29.1 (19.) 47.8 (17.)
 Trefferlage 0.00 mm , 0.15 mm hoch
 Streuwert 1.11, horizontal: 0.93, vertikal: 1.27

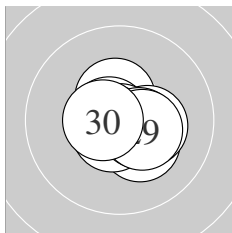

Serie 3:
 10.5 * 10.3 * 10.3 * 10.7 * 10.9 *
 10.7 * 10.6 * 10.5 * 10.4 * 10.6 *
 beste Teiler 22.0 (25.) 55.0 (26.) 60.1 (24.)
 Trefferlage 0.23 mm rechts, 0.22 mm tief
 Streuwert 0.78, horizontal: 0.91, vertikal: 0.62

Unterschrift des Schützen

Ergebnis: **310.2** (297)
 Serien: 102.8 103.9 103.5
 Zähler: 27 3 0 0 0 0 0 0 0 0
 Innenzehner: 22
 weiteste: 326 (9), 307 (13), 262 (3)
 beste Teiler 39.5 (20.) 42.0 (8.) 50.0 (17.)
 Trefferlage 0.00 mm , 0.18 mm hoch
 Streuwert 1.22, horizontal: 1.19, vertikal: 1.25

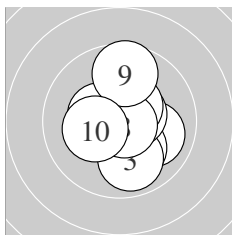
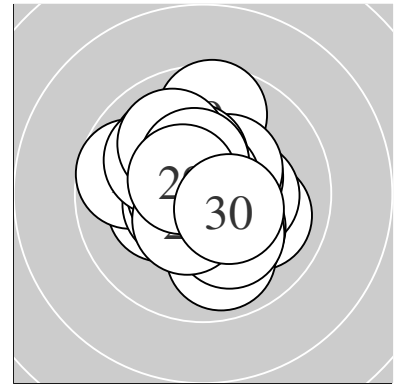

Serie 1:
 10.0 ↘ 10.1 ↘ 9.9 ↘ 10.5 * 10.7 *
 10.5 * 10.4 * 10.8 * 9.6 ↑ 10.3 *
 beste Teiler 42.0 (8.) 61.2 (5.) 108.6 (4.)
 Trefferlage 0.32 mm rechts, 0.02 mm tief
 Streuwert 1.39, horizontal: 1.13, vertikal: 1.60

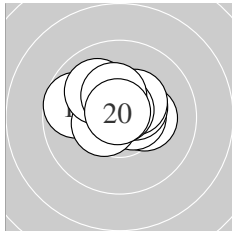

Serie 2:
 10.3 * 10.6 * 9.7 ↖ 10.5 * 10.4 *
 10.5 * 10.8 * 10.0 ↘ 10.3 * 10.8 *
 beste Teiler 39.5 (20.) 50.0 (17.) 93.0 (12.)
 Trefferlage 0.13 mm links, 0.61 mm hoch
 Streuwert 1.11, horizontal: 1.42, vertikal: 0.68

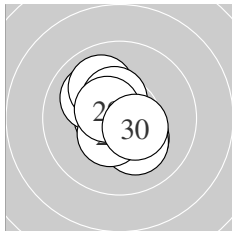

Serie 3:
 10.6 * 10.6 * 10.2 * 10.2 * 10.0 ↖
 10.0 ↘ 10.4 * 10.5 * 10.5 * 10.5 *
 beste Teiler 87.0 (21.) 97.7 (22.) 103.2 (29.)
 Trefferlage 0.22 mm links, 0.02 mm tief
 Streuwert 1.18, horizontal: 1.06, vertikal: 1.29

Unterschrift des Schützen

Ergebnis: **309.9** (298)
 Serien: 103.8 103.1 103.0
 Zähler: 28 2 0 0 0 0 0 0 0 0
 Innenzehner: 20
 weiteste: 281 (29), 260 (5), 221 (14)
 beste Teiler 46.0 (13.) 66.8 (9.) 70.4 (18.)
 Trefferlage 0.12 mm links, 0.43 mm tief
 Streuwert 1.15, horizontal: 1.11, vertikal: 1.18

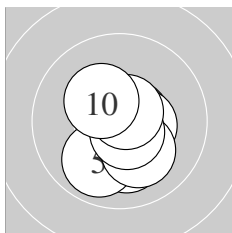
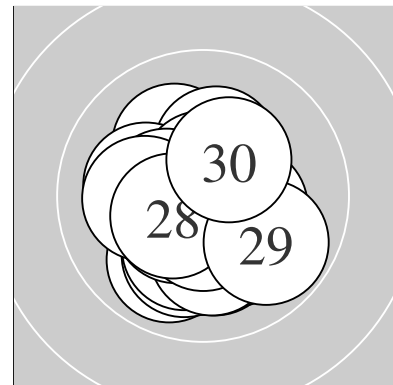

Serie 1:
 10.5 * 10.1 ↓ 10.6 * 10.5 * 9.9 ↙
 10.5 * 10.1 ↘ 10.6 * 10.7 * 10.3 *
 beste Teiler 66.8 (9.) 78.5 (3.) 79.0 (8.)
 Trefferlage 0.41 mm rechts, 0.59 mm tief
 Streuwert 1.02, horizontal: 0.88, vertikal: 1.14

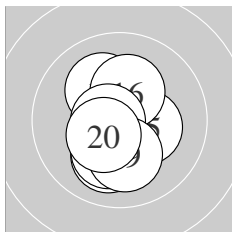

Serie 2:
 10.1 ↓ 10.1 ↖ 10.8 * 10.1 ↙ 10.3 *
 10.3 * 10.2 * 10.7 * 10.1 ↓ 10.4 *
 beste Teiler 46.0 (13.) 70.4 (18.) 130.9 (20.)
 Trefferlage 0.17 mm links, 0.64 mm tief
 Streuwert 1.18, horizontal: 0.80, vertikal: 1.47

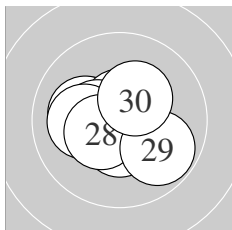

Serie 3:
 10.5 * 10.2 * 10.1 ← 10.6 * 10.6 *
 10.4 * 10.1 ← 10.4 * 9.8 ↘ 10.3 *
 beste Teiler 81.0 (25.) 92.1 (24.) 117.0 (21.)
 Trefferlage 0.60 mm links, 0.07 mm tief
 Streuwert 1.18, horizontal: 1.41, vertikal: 0.90

Unterschrift des Schützen

Ergebnis: **299.5** (287)
 Serien: 102.2 98.9 98.4
 Zähler: 19 9 2 0 0 0 0 0 0 0
 Innenzehner: 14
 weiteste: 689 (19), 507 (21), 478 (28)
 beste Teiler 25.0 (10.) 51.2 (12.) 69.6 (8.)
 Trefferlage 0.54 mm rechts, 0.36 mm hoch
 Streuwert 1.97, horizontal: 2.30, vertikal: 1.58

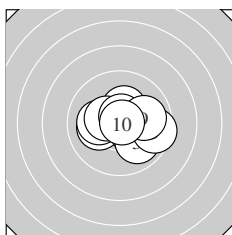
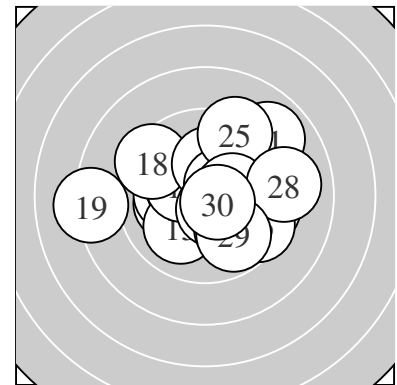

Serie 1:
 10.1 ← 10.3 * 9.9 ↘ 10.3 * 9.5 →
 10.1 ← 10.4 * 10.7 * 10.0 → 10.9 *
 beste Teiler 25.0 (10.) 69.6 (8.) 138.2 (7.)
 Trefferlage 0.44 mm rechts, 0.05 mm tief
 Streuwert 1.48, horizontal: 1.87, vertikal: 0.94

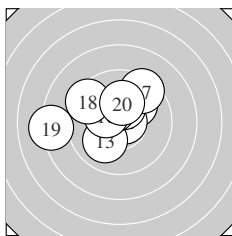

Serie 2:
 10.0 ↗ 10.7 * 10.0 ↙ 10.3 * 10.4 *
 10.3 * 9.4 ↗ 9.4 ↘ 8.2 ← 10.2 *
 beste Teiler 51.2 (12.) 136.8 (15.) 152.0 (16.)
 Trefferlage 0.85 mm links, 0.98 mm hoch
 Streuwert 2.12, horizontal: 2.63, vertikal: 1.44

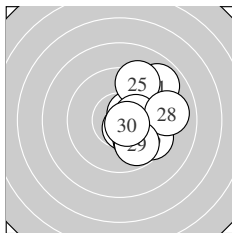

Serie 3:
 8.9 ↗ 10.6 * 9.9 ↘ 10.5 * 9.3 ↗
 9.5 ↘ 10.3 * 9.0 → 9.8 ↘ 10.6 *
 beste Teiler 84.0 (30.) 94.3 (22.) 118.7 (24.)
 Trefferlage 2.06 mm rechts, 0.15 mm hoch
 Streuwert 1.77, horizontal: 1.38, vertikal: 2.09

Unterschrift des Schützen

Ergebnis: **307.9** (295)
 Serien: 103.0 102.4 102.5
 Zähler: 25 5 0 0 0 0 0 0 0 0
 Innenzehner: 18
 weiteste: 337 (25), 333 (17), 327 (16)
 beste Teiler 26.0 (1.) 46.1 (23.) 57.2 (12.)
 Trefferlage 0.27 mm links, 0.15 mm tief
 Streuwert 1.37, horizontal: 1.71, vertikal: 0.89

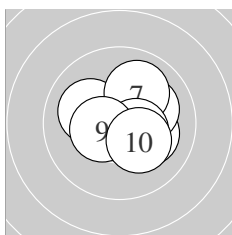
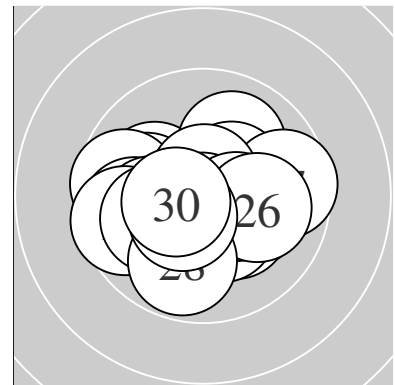

Serie 1:
 10.8 * 10.5 * 10.2 * 10.1 ↖ 10.2 *
 10.1 ↗ 10.0 ↗ 10.5 * 10.4 * 10.2 *
 beste Teiler 26.0 (1.) 113.2 (2.) 125.6 (8.)
 Trefferlage 0.16 mm rechts, 0.20 mm hoch
 Streuwert 1.27, horizontal: 1.52, vertikal: 0.97

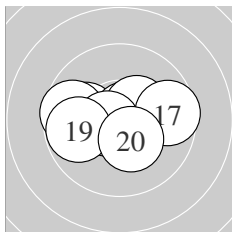

Serie 2:
 10.0 ← 10.7 * 10.7 * 10.7 * 10.4 *
 9.6 ← 9.6 → 10.6 * 9.8 ← 10.3 *
 beste Teiler 57.2 (12.) 58.0 (14.) 62.3 (13.)
 Trefferlage 0.35 mm links, 0.03 mm hoch
 Streuwert 1.51, horizontal: 2.03, vertikal: 0.65

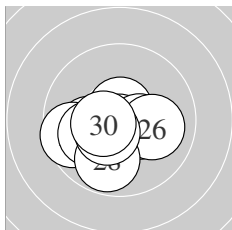

Serie 3:
 10.1 ← 10.7 * 10.8 * 10.4 * 9.6 ←
 10.0 → 10.1 ← 9.8 ↓ 10.5 * 10.5 *
 beste Teiler 46.1 (23.) 71.1 (22.) 114.7 (30.)
 Trefferlage 0.64 mm links, 0.70 mm tief
 Streuwert 1.30, horizontal: 1.63, vertikal: 0.85

Unterschrift des Schützen

Ergebnis: **301.6** (286)
 Serien: 100.1 100.5 101.0
 Zähler: 17 12 1 0 0 0 0 0 0 0
 Innenzehner: 16
 weiteste: 519 (15), 419 (1), 396 (12)
 beste Teiler 68.5 (21.) 69.4 (17.) 81.3 (9.)
 Trefferlage 0.66 mm links, 0.38 mm hoch
 Streuwert 1.73, horizontal: 1.95, vertikal: 1.48

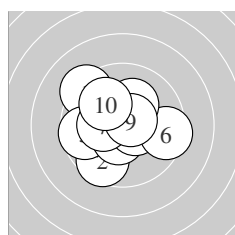
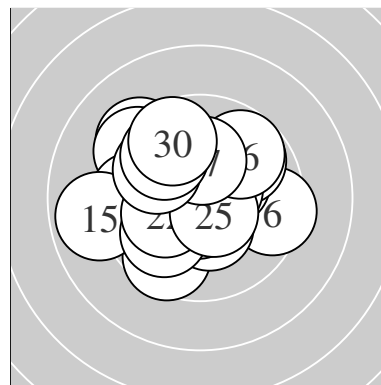

Serie 1:
 9.3 ↖ 9.6 ↙ 9.6 ← 10.5 * 10.5 *
 9.5 → 10.3 * 10.2 * 10.6 * 10.0 ↘
 beste Teiler 81.3 (9.) 111.9 (5.) 116.3 (4.)
 Trefferlage 0.51 mm links, 0.11 mm hoch
 Streuwert 1.92, horizontal: 2.12, vertikal: 1.68

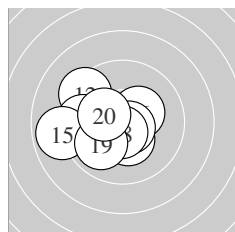

Serie 2:
 10.3 * 9.4 ↖ 10.5 * 9.6 ← 8.9 ←
 10.3 * 10.7 * 10.6 * 9.9 ↙ 10.3 *
 beste Teiler 69.4 (17.) 85.7 (18.) 119.1 (13.)
 Trefferlage 1.39 mm links, 0.15 mm tief
 Streuwert 1.68, horizontal: 2.04, vertikal: 1.23

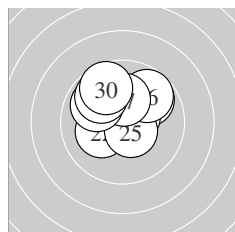

Serie 3:
 10.7 * 10.2 * 9.8 ↗ 10.5 * 10.5 *
 9.7 ↗ 10.2 * 9.9 ↖ 9.8 ↖ 9.7 ↖
 beste Teiler 68.5 (21.) 103.2 (25.) 105.5 (24.)
 Trefferlage 0.08 mm links, 1.19 mm hoch
 Streuwert 1.45, horizontal: 1.61, vertikal: 1.27

Unterschrift des Schützen

Meyton Elektronik

Ergebnis: **310.7** (297)
 Serien: 104.4 102.8 103.5
 Zähler: 27 3 0 0 0 0 0 0 0 0
 Innenzehner: 25
 weiteste: 398 (20), 282 (28), 267 (27)
 beste Teiler 52.0 (24.) 72.0 (10.) 85.1 (6.)
 Trefferlage 0.11 mm links, 0.17 mm hoch
 Streuwert 1.17, horizontal: 1.27, vertikal: 1.06

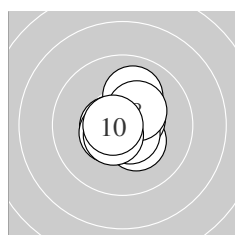
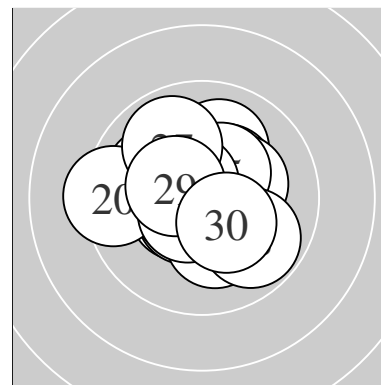

Serie 1:
 10.3 * 10.3 * 10.6 * 10.5 * 10.5 *
 10.6 * 10.0 † 10.4 * 10.5 * 10.7 *
 beste Teiler 72.0 (10.) 85.1 (6.) 97.4 (3.)
 Trefferlage 0.16 mm rechts, 0.18 mm hoch
 Streuwert 0.98, horizontal: 0.89, vertikal: 1.07

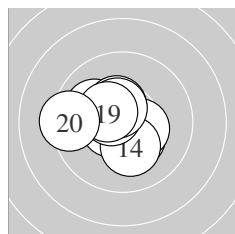

Serie 2:
 10.3 * 10.6 * 10.4 * 10.2 * 10.0 ↖
 10.4 * 10.6 * 10.5 * 10.4 * 9.4 ←
 beste Teiler 94.5 (12.) 96.7 (17.) 112.7 (18.)
 Trefferlage 0.69 mm links, 0.07 mm hoch
 Streuwert 1.30, horizontal: 1.54, vertikal: 1.02

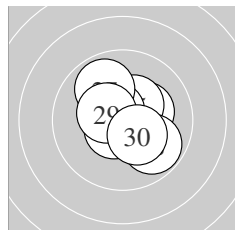

Serie 3:
 10.5 * 10.3 * 10.6 * 10.7 * 10.4 *
 10.6 * 9.9 ↗ 9.8 ↘ 10.4 * 10.3 *
 beste Teiler 52.0 (24.) 87.0 (26.) 91.2 (23.)
 Trefferlage 0.19 mm rechts, 0.26 mm hoch
 Streuwert 1.21, horizontal: 1.22, vertikal: 1.20

Unterschrift des Schützen

Meyton Elektronik

Ergebnis: **315.3** (298)
 Serien: 104.8 105.9 104.6
 Zähler: 28 2 0 0 0 0 0 0 0 0
 Innenzehner: 27
 weiteste: 315 (2), 254 (27), 213 (24)
 beste Teiler 36.4 (25.) 37.4 (16.) 38.1 (5.)
 Trefferlage 0.00 mm , 0.35 mm tief
 Streuwert 0.90, horizontal: 1.03, vertikal: 0.74

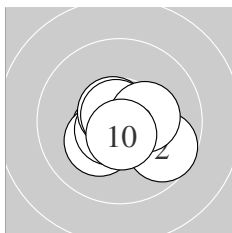
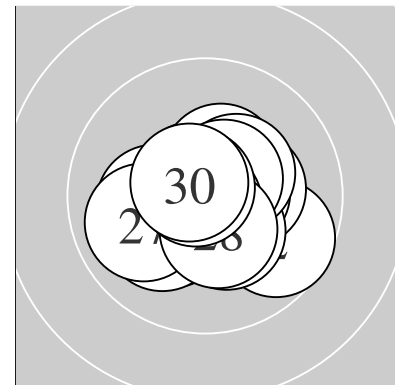

Serie 1:
 10.5 * 9.7 ↘ 10.6 * 10.2 * 10.8 *
 10.6 * 10.7 * 10.8 * 10.3 * 10.6 *
 beste Teiler 38.1 (5.) 46.1 (8.) 72.2 (7.)
 Trefferlage 0.20 mm rechts, 0.43 mm tief
 Streuwert 1.00, horizontal: 1.22, vertikal: 0.70

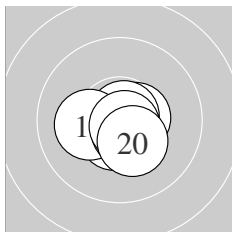

Serie 2:
 10.8 * 10.7 * 10.5 * 10.6 * 10.6 *
 10.8 * 10.2 * 10.6 * 10.8 * 10.3 *
 beste Teiler 37.4 (16.) 48.2 (19.) 50.6 (11.)
 Trefferlage 0.03 mm rechts, 0.52 mm tief
 Streuwert 0.66, horizontal: 0.80, vertikal: 0.49

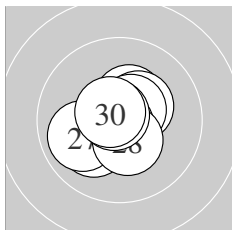

Serie 3:
 10.4 * 10.4 * 10.6 * 10.1 ↙ 10.8 *
 10.6 * 9.9 ↖ 10.4 * 10.8 * 10.6 *
 beste Teiler 36.4 (25.) 47.4 (29.) 77.8 (26.)
 Trefferlage 0.24 mm links, 0.09 mm tief
 Streuwert 1.03, horizontal: 1.10, vertikal: 0.95

Unterschrift des Schützen

Ergebnis: **301.8** (290)
 Serien: 100.6 102.5 98.7
 Zähler: 21 8 1 0 0 0 0 0 0 0
 Innenzehner: 15
 weiteste: 591 (26), 488 (5), 452 (25)
 beste Teiler 20.2 (8.) 82.7 (18.) 94.0 (3.)
 Trefferlage 0.42 mm rechts, 0.02 mm tief
 Streuwert 1.81, horizontal: 2.27, vertikal: 1.19

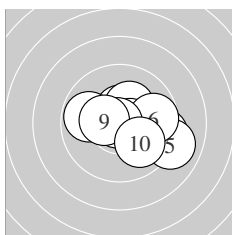
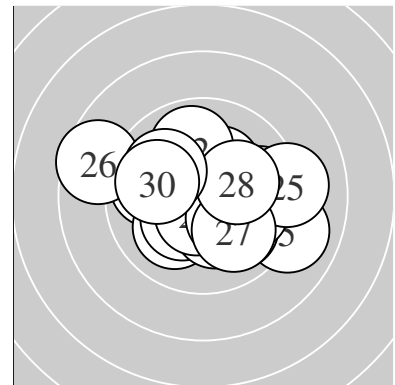

Serie 1:
 10.5 * 10.3 * 10.6 * 9.4 → 9.0 ↘
 9.7 → 9.8 ← 10.9 * 10.4 * 10.0 ↘
 beste Teiler 20.2 (8.) 94.0 (3.) 116.1 (1.)
 Trefferlage 1.07 mm rechts, 0.05 mm tief
 Streuwert 1.80, horizontal: 2.29, vertikal: 1.12

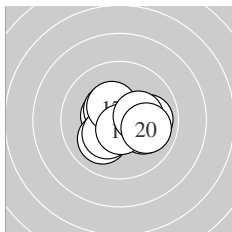

Serie 2:
 9.9 → 10.4 * 10.4 * 10.1 ↘ 10.1 ↙
 10.3 * 10.4 * 10.6 * 10.3 * 10.0 →
 beste Teiler 82.7 (18.) 130.2 (12.) 134.3 (13.)
 Trefferlage 0.32 mm rechts, 0.22 mm tief
 Streuwert 1.35, horizontal: 1.65, vertikal: 0.95

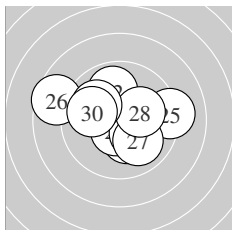

Serie 3:
 10.2 * 9.9 ↑ 10.6 * 10.2 * 9.1 →
 8.6 ↙ 10.0 ↘ 10.2 * 10.0 ↙ 9.9 ←
 beste Teiler 100.3 (23.) 176.4 (21.) 177.0 (24.)
 Trefferlage 0.11 mm links, 0.22 mm hoch
 Streuwert 2.26, horizontal: 2.80, vertikal: 1.52

Unterschrift des Schützen

Ergebnis: **306.4** (295)
 Serien: 103.2 100.3 102.9
 Zähler: 25 5 0 0 0 0 0 0 0 0
 Innenzehner: 19
 weiteste: 330 (16), 310 (13), 291 (19)
 beste Teiler 30.5 (1.) 81.4 (15.) 97.1 (28.)
 Trefferlage 0.27 mm rechts, 0.72 mm tief
 Streuwert 1.29, horizontal: 1.12, vertikal: 1.44

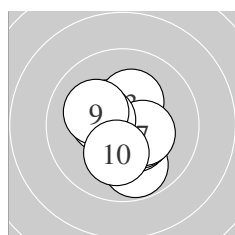
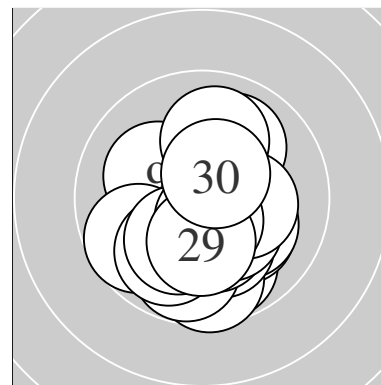

Serie 1:
 10.8 * 10.4 * 10.3 * 9.8 ↘ 10.4 *
 10.4 * 10.4 * 10.4 * 10.1 ↖ 10.2 *
 beste Teiler 30.5 (1.) 130.8 (5.) 131.1 (2.)
 Trefferlage 0.06 mm rechts, 0.30 mm tief
 Streuwert 1.24, horizontal: 1.13, vertikal: 1.33

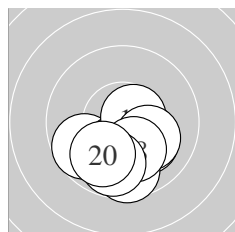

Serie 2:
 10.2 * 10.1 ↘ 9.7 ↙ 10.2 * 10.6 *
 9.6 ↓ 10.1 ↘ 10.1 ↓ 9.8 ↓ 9.9 ↙
 beste Teiler 81.4 (15.) 180.9 (11.) 187.9 (14.)
 Trefferlage 0.15 mm rechts, 1.67 mm tief
 Streuwert 1.24, horizontal: 1.43, vertikal: 1.02

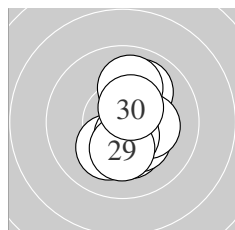

Serie 3:
 10.5 * 10.3 * 10.0 ↗ 10.2 * 10.0 ↑
 10.3 * 10.3 * 10.6 * 10.2 * 10.5 *
 beste Teiler 97.1 (28.) 109.2 (21.) 114.6 (30.)
 Trefferlage 0.59 mm rechts, 0.20 mm tief
 Streuwert 1.22, horizontal: 0.75, vertikal: 1.55

Unterschrift des Schützen

Meyton Elektronik

Ergebnis: **300.4** (286)
 Serien: 100.3 99.3 100.8
 Zähler: 16 14 0 0 0 0 0 0 0 0
 Innenzehner: 13
 weiteste: 432 (20), 417 (13), 399 (22)
 beste Teiler 17.7 (1.) 88.4 (8.) 91.0 (27.)
 Trefferlage 0.35 mm links, 0.58 mm tief
 Streuwert 1.82, horizontal: 1.98, vertikal: 1.64

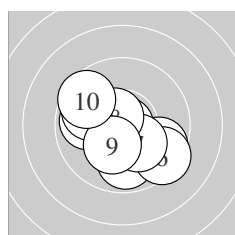
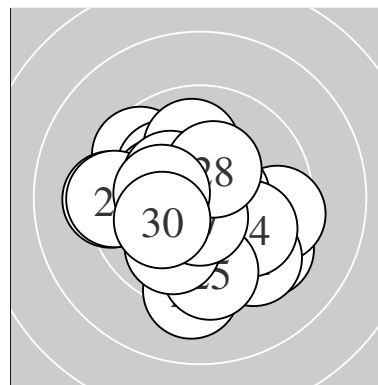

Serie 1:
 10.9 * 9.9 ← 9.9 ↓ 9.9 ↖ 9.6 ↗
 9.4 ↘ 10.2 * 10.6 * 10.3 * 9.6 ↖
 beste Teiler 17.7 (1.) 88.4 (8.) 173.5 (9.)
 Trefferlage 0.18 mm links, 0.56 mm tief
 Streuwert 1.87, horizontal: 2.13, vertikal: 1.58

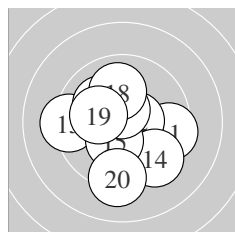

Serie 2:
 9.5 → 10.6 * 9.3 ← 9.5 ↘ 10.3 *
 10.1 ↖ 10.6 * 10.0 ↑ 10.2 * 9.2 ↓
 beste Teiler 95.6 (17.) 100.6 (12.) 156.2 (15.)
 Trefferlage 0.21 mm links, 0.39 mm tief
 Streuwert 2.11, horizontal: 2.21, vertikal: 2.00

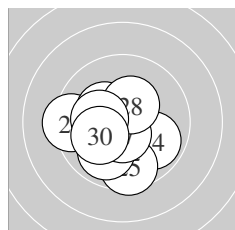

Serie 3:
 10.4 * 9.4 ← 10.3 * 9.9 ↘ 9.6 ↓
 9.9 ↙ 10.6 * 10.4 * 10.2 * 10.1 ↖
 beste Teiler 91.0 (27.) 139.5 (21.) 146.7 (28.)
 Trefferlage 0.66 mm links, 0.80 mm tief
 Streuwert 1.60, horizontal: 1.74, vertikal: 1.44

Unterschrift des Schützen

Meyton Elektronik

Ergebnis: **304.5** (294)
 Serien: 102.1 100.5 101.9
 Zähler: 24 6 0 0 0 0 0 0 0 0
 Innenzehner: 15
 weiteste: 477 (12), 413 (22), 288 (20)
 beste Teiler 18.6 (10.) 43.1 (19.) 84.8 (30.)
 Trefferlage 0.36 mm rechts, 0.34 mm tief
 Streuwert 1.55, horizontal: 1.85, vertikal: 1.17

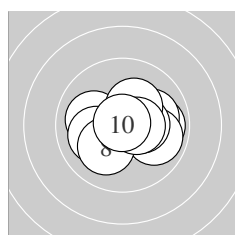
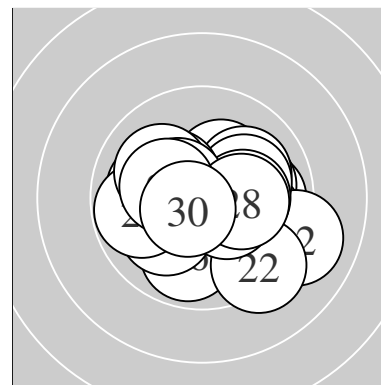

Serie 1:
 9.9 → 10.0 → 10.0 ← 9.9 ↘ 10.4 *
 10.1 ← 10.3 * 10.1 ↙ 10.5 * 10.9 *
 beste Teiler 18.6 (10.) 110.1 (9.) 146.0 (5.)
 Trefferlage 0.51 mm rechts, 0.06 mm tief
 Streuwert 1.44, horizontal: 1.84, vertikal: 0.86

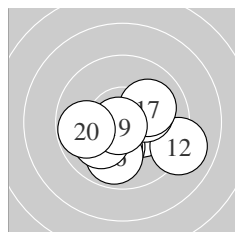

Serie 2:
 10.3 * 9.0 ↘ 10.2 * 10.1 ↓ 10.2 *
 9.9 ↓ 10.1 ↗ 10.1 ↙ 10.8 * 9.8 ←
 beste Teiler 43.1 (19.) 156.2 (11.) 187.7 (15.)
 Trefferlage 0.28 mm rechts, 0.93 mm tief
 Streuwert 1.72, horizontal: 2.10, vertikal: 1.23

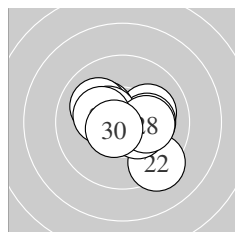

Serie 3:
 10.1 → 9.3 ↘ 10.2 * 10.3 * 10.1 ↘
 10.4 * 10.4 * 10.2 * 10.3 * 10.6 *
 beste Teiler 84.8 (30.) 126.5 (27.) 132.8 (26.)
 Trefferlage 0.28 mm rechts, 0.04 mm tief
 Streuwert 1.54, horizontal: 1.78, vertikal: 1.26

Unterschrift des Schützen

Meyton Elektronik

Ergebnis: **300.4** (288)
 Serien: 98.8 100.3 101.3
 Zähler: 19 10 1 0 0 0 0 0 0 0
 Innenzehner: 11
 weiteste: 560 (14), 471 (10), 449 (18)
 beste Teiler 38.0 (19.) 45.6 (17.) 53.0 (22.)
 Trefferlage 0.04 mm links, 0.16 mm tief
 Streuwert 1.92, horizontal: 2.25, vertikal: 1.50

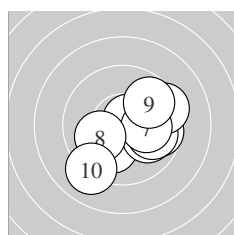
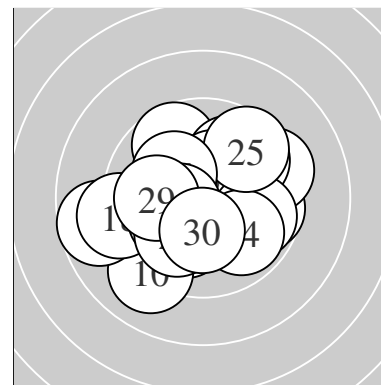

Serie 1:
 10.1 ↙ 10.7 * 9.7 → 10.0 ↘ 9.9 →
 9.4 → 10.1 → 10.1 ← 9.7 ↗ 9.1 ↙
 beste Teiler 69.3 (2.) 209.6 (7.) 217.4 (1.)
 Trefferlage 1.07 mm rechts, 0.53 mm tief
 Streuwert 1.97, horizontal: 2.24, vertikal: 1.66

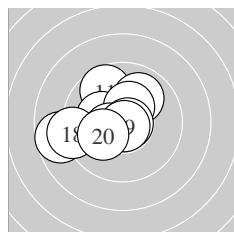

Serie 2:
 9.7 ↖ 10.0 ↗ 10.2 * 8.7 ← 10.4 *
 10.4 * 10.8 * 9.2 ← 10.8 * 10.1 ←
 beste Teiler 38.0 (19.) 45.6 (17.) 126.5 (16.)
 Trefferlage 1.34 mm links, 0.22 mm hoch
 Streuwert 1.84, horizontal: 2.19, vertikal: 1.41

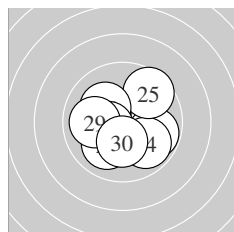

Serie 3:
 10.4 * 10.7 * 9.8 → 9.9 ↘ 9.6 ↗
 10.2 * 10.4 * 10.0 ↙ 10.0 ← 10.3 *
 beste Teiler 53.0 (22.) 135.0 (27.) 139.5 (21.)
 Trefferlage 0.14 mm rechts, 0.16 mm tief
 Streuwert 1.65, horizontal: 1.81, vertikal: 1.48

 Unterschrift des Schützen

Meyton Elektronik

Ergebnis: **303.3** (293)
 Serien: 102.1 102.3 98.9
 Zähler: 23 7 0 0 0 0 0 0 0 0
 Innenzehner: 15
 weiteste: 460 (28), 423 (21), 368 (30)
 beste Teiler 77.8 (18.) 95.1 (7.) 98.4 (2.)
 Trefferlage 0.58 mm rechts, 1.33 mm tief
 Streuwert 1.32, horizontal: 1.35, vertikal: 1.28

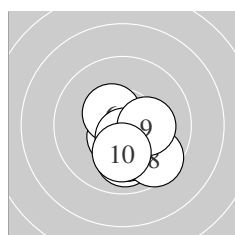
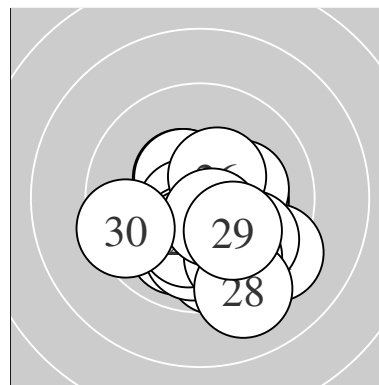

Serie 1:
 10.1 ↘ 10.6 * 10.0 ↓ 10.3 * 10.1 ↓
 10.5 * 10.6 * 9.6 ↘ 10.2 * 10.1 ↓
 beste Teiler 95.1 (7.) 98.4 (2.) 123.1 (6.)
 Trefferlage 0.59 mm rechts, 1.22 mm tief
 Streuwert 1.10, horizontal: 1.04, vertikal: 1.15

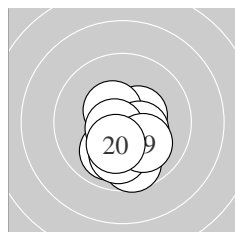

Serie 2:
 9.7 ↓ 10.4 * 10.0 ↙ 10.3 * 10.5 *
 10.0 ↓ 10.4 * 10.6 * 10.1 ↘ 10.3 *
 beste Teiler 77.8 (18.) 119.2 (15.) 128.0 (12.)
 Trefferlage 0.17 mm rechts, 1.22 mm tief
 Streuwert 1.13, horizontal: 0.96, vertikal: 1.29

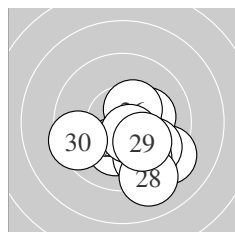

Serie 3:
 9.3 ↘ 10.2 * 10.2 * 9.8 ↘ 9.7 ↘
 10.5 * 10.5 * 9.1 ↓ 10.1 ↘ 9.5 ←
 beste Teiler 104.9 (27.) 125.2 (26.) 186.5 (22.)
 Trefferlage 0.98 mm rechts, 1.55 mm tief
 Streuwert 1.69, horizontal: 1.88, vertikal: 1.49

Unterschrift des Schützen

Meyton Elektronik

Ergebnis: **307.2** (292)
 Serien: 101.3 102.9 103.0
 Zähler: 22 8 0 0 0 0 0 0 0 0
 Innenzehner: 20
 weiteste: 398 (21), 356 (4), 300 (7)
 beste Teiler 20.8 (27.) 42.8 (10.) 53.0 (24.)
 Trefferlage 0.17 mm links, 0.57 mm tief
 Streuwert 1.37, horizontal: 1.39, vertikal: 1.34

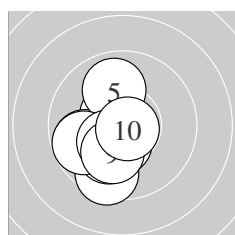
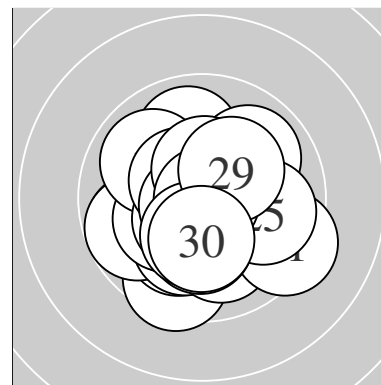

Serie 1:
 10.5 * 9.8 ← 10.4 * 9.5 ↓ 9.9 ↑
 10.1 ↓ 9.8 ← 10.3 * 10.2 * 10.8 *
 beste Teiler 42.8 (10.) 104.2 (1.) 127.0 (3.)
 Trefferlage 1.04 mm links, 0.91 mm tief
 Streuwert 1.32, horizontal: 0.97, vertikal: 1.59

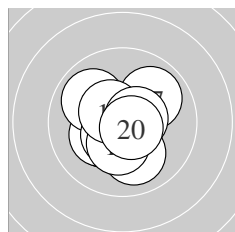

Serie 2:
 10.3 * 10.2 * 10.0 ↓ 9.9 ↘ 10.5 *
 10.3 * 9.9 ↗ 10.5 * 10.6 * 10.7 *
 beste Teiler 72.4 (20.) 99.4 (19.) 113.4 (18.)
 Trefferlage 0.24 mm links, 0.25 mm tief
 Streuwert 1.28, horizontal: 1.28, vertikal: 1.28

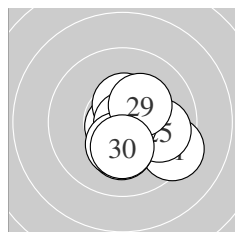

Serie 3:
 9.4 ↘ 10.2 * 10.5 * 10.7 * 9.9 →
 10.5 * 10.9 * 10.3 * 10.3 * 10.3 *
 beste Teiler 20.8 (27.) 53.0 (24.) 104.1 (23.)
 Trefferlage 0.77 mm rechts, 0.55 mm tief
 Streuwert 1.26, horizontal: 1.33, vertikal: 1.19

Unterschrift des Schützen

Ergebnis: **303.5** (290)
 Serien: 102.4 98.9 102.2
 Zähler: 21 8 1 0 0 0 0 0 0 0
 Innenzehner: 15
 weiteste: 534 (11), 410 (16), 382 (4)
 beste Teiler 53.7 (29.) 62.1 (3.) 63.2 (26.)
 Trefferlage 0.98 mm links, 0.11 mm hoch
 Streuwert 1.56, horizontal: 1.78, vertikal: 1.31

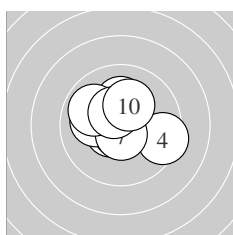
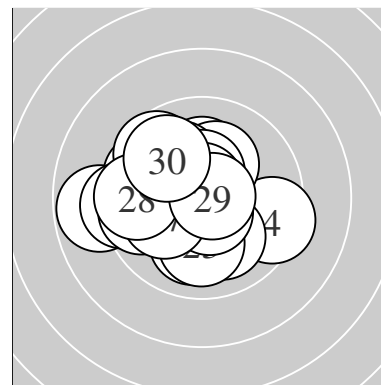

Serie 1:
 10.6 * 10.2 * 10.7 * 9.4 ↗ 10.1 ←
 10.2 * 10.6 * 9.9 ↖ 10.5 * 10.2 *
 beste Teiler 62.1 (3.) 79.2 (7.) 97.0 (1.)
 Trefferlage 0.13 mm links, 0.52 mm hoch
 Streuwert 1.45, horizontal: 1.65, vertikal: 1.21

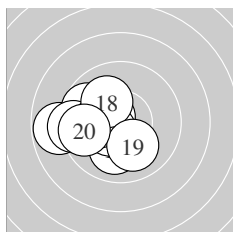

Serie 2:
 8.8 ← 10.0 ↓ 9.7 ↖ 10.5 * 10.5 *
 9.3 ← 10.2 * 10.1 ↖ 10.1 ↓ 9.7 ←
 beste Teiler 108.2 (14.) 115.8 (15.) 189.0 (17.)
 Trefferlage 1.99 mm links, 0.32 mm tief
 Streuwert 1.60, horizontal: 1.88, vertikal: 1.25

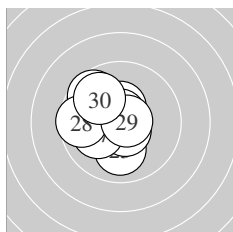

Serie 3:
 10.6 * 9.6 ↖ 10.0 ↓ 10.4 * 10.6 *
 10.7 * 10.1 ← 9.6 ← 10.7 * 9.9 ↖
 beste Teiler 53.7 (29.) 63.2 (26.) 82.3 (25.)
 Trefferlage 0.84 mm links, 0.15 mm hoch
 Streuwert 1.42, horizontal: 1.40, vertikal: 1.44

Unterschrift des Schützen

Meyton Elektronik

Ergebnis: **303.9** (289)
 Serien: 101.8 100.1 102.0
 Zähler: 20 9 1 0 0 0 0 0 0 0
 Innenzehner: 19
 weiteste: 630 (19), 395 (17), 335 (8)
 beste Teiler 55.9 (24.) 58.0 (4.) 78.2 (6.)
 Trefferlage 0.11 mm links, 0.41 mm tief
 Streuwert 1.69, horizontal: 2.04, vertikal: 1.26

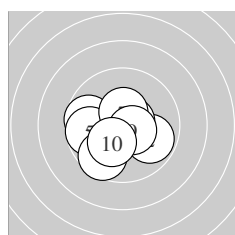
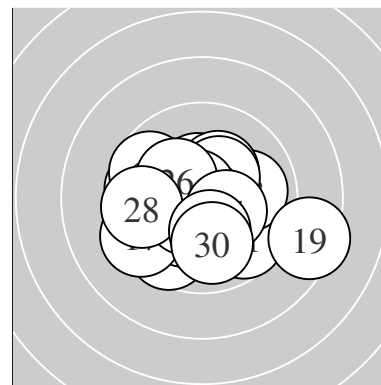

Serie 1:
 10.4 * 9.8 ↘ 9.7 ← 10.7 * 9.7 ←
 10.6 * 10.5 * 9.6 ↙ 10.6 * 10.2 *
 beste Teiler 58.0 (4.) 78.2 (6.) 98.4 (9.)
 Trefferlage 0.61 mm links, 0.58 mm tief
 Streuwert 1.48, horizontal: 1.76, vertikal: 1.14

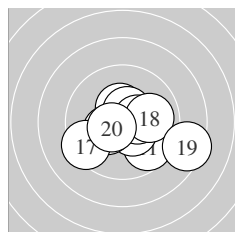

Serie 2:
 9.7 ↘ 10.5 * 10.4 * 10.3 * 10.5 *
 10.4 * 9.4 ↙ 10.0 → 8.4 → 10.5 *
 beste Teiler 109.3 (15.) 110.9 (20.) 125.9 (12.)
 Trefferlage 0.73 mm rechts, 0.56 mm tief
 Streuwert 2.02, horizontal: 2.53, vertikal: 1.31

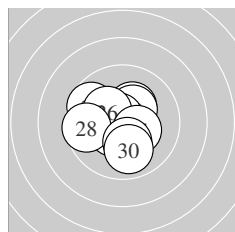

Serie 3:
 10.3 * 9.7 ↘ 10.4 * 10.7 * 10.5 *
 10.3 * 10.4 * 9.6 ← 10.2 * 9.9 ↓
 beste Teiler 55.9 (24.) 124.4 (25.) 147.8 (23.)
 Trefferlage 0.47 mm links, 0.09 mm tief
 Streuwert 1.51, horizontal: 1.62, vertikal: 1.40

Unterschrift des Schützen

Meyton Elektronik

Ergebnis: **304.0** (291)
 Serien: 100.1 102.1 101.8
 Zähler: 21 9 0 0 0 0 0 0 0 0
 Innenzehner: 15
 weiteste: 368 (22), 359 (3), 350 (7)
 beste Teiler 53.6 (1.) 76.0 (30.) 86.0 (14.)
 Trefferlage 0.05 mm links, 0.15 mm tief
 Streuwert 1.59, horizontal: 1.54, vertikal: 1.63

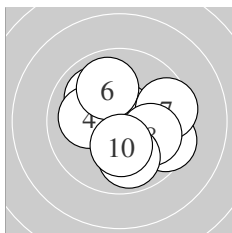
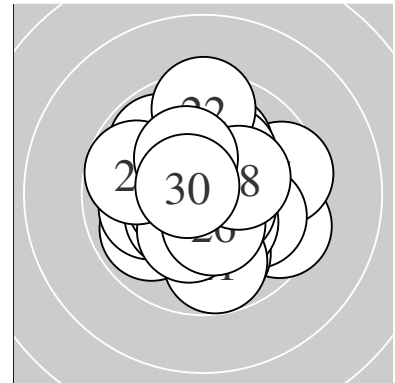

Serie 1:
 10.7 * 10.0 ↘ 9.5 ↘ 10.1 ← 10.1 ↓
 9.9 ↗ 9.6 → 10.0 → 9.9 ↓ 10.3 *
 beste Teiler 53.6 (1.) 175.4 (10.) 203.1 (5.)
 Trefferlage 0.57 mm rechts, 0.29 mm tief
 Streuwert 1.81, horizontal: 1.93, vertikal: 1.67

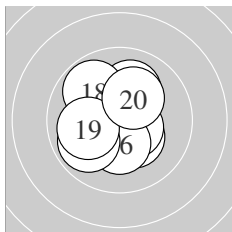

Serie 2:
 10.3 * 10.1 ↑ 10.4 * 10.6 * 10.5 *
 10.3 * 9.9 ↙ 9.8 ↘ 10.0 ← 10.2 *
 beste Teiler 86.0 (14.) 105.6 (15.) 134.4 (13.)
 Trefferlage 0.27 mm links, 0.18 mm tief
 Streuwert 1.43, horizontal: 1.36, vertikal: 1.50

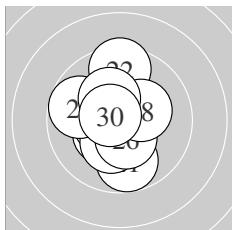

Serie 3:
 9.8 ↓ 9.5 ↑ 10.4 * 10.5 * 10.3 *
 10.4 * 9.7 ← 10.3 * 10.3 * 10.6 *
 beste Teiler 76.0 (30.) 110.0 (24.) 135.6 (26.)
 Trefferlage 0.45 mm links, 0.01 mm hoch
 Streuwert 1.56, horizontal: 1.20, vertikal: 1.86

Unterschrift des Schützen

Ergebnis: **292.5** (282)
 Serien: 96.2 98.0 98.3
 Zähler: 15 12 3 0 0 0 0 0 0 0
 Innenzehner: 7
 weiteste: 592 (23), 553 (9), 514 (1)
 beste Teiler 32.8 (3.) 68.2 (27.) 169.5 (30.)
 Trefferlage 1.29 mm links, 0.51 mm tief
 Streuwert 2.16, horizontal: 2.83, vertikal: 1.14

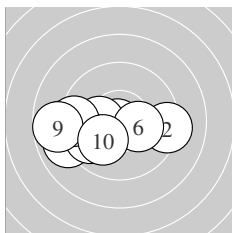
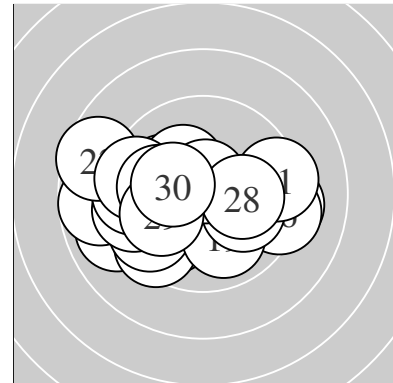

Serie 1:
 8.9 ← 9.2 → 10.8 * 9.0 ← 10.2 *
 10.3 * 9.7 ↙ 9.3 ← 8.7 ← 10.1 ↘
 beste Teiler 32.8 (3.) 173.7 (6.) 181.0 (5.)
 Trefferlage 1.95 mm links, 0.74 mm tief
 Streuwert 2.28, horizontal: 3.15, vertikal: 0.70

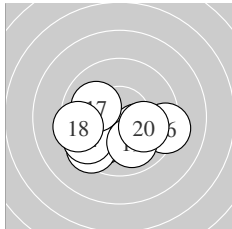

Serie 2:
 9.9 ↗ 10.1 ↗ 9.5 ↗ 9.6 ↗ 10.2 *
 9.3 → 10.0 ↖ 9.4 ← 10.0 ↓ 10.0 →
 beste Teiler 189.7 (15.) 209.3 (12.) 229.1 (17.)
 Trefferlage 0.52 mm links, 1.32 mm tief
 Streuwert 1.96, horizontal: 2.57, vertikal: 1.03

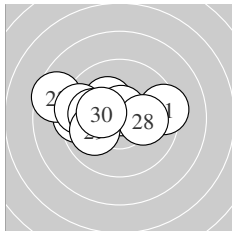

Serie 3:
 9.4 → 9.5 ← 8.6 ↖ 10.2 * 9.5 ←
 10.0 ← 10.7 * 10.1 → 10.0 ← 10.3 *
 beste Teiler 68.2 (27.) 169.5 (30.) 180.2 (24.)
 Trefferlage 1.40 mm links, 0.52 mm hoch
 Streuwert 2.09, horizontal: 2.84, vertikal: 0.82

Unterschrift des Schützen

Ergebnis: **313.2** (296)
 Serien: 103.1 105.4 104.7
 Zähler: 26 4 0 0 0 0 0 0 0 0
 Innenzehner: 25
 weiteste: 338 (10), 311 (28), 275 (11)
 beste Teiler 35.1 (18.) 36.0 (23.) 36.7 (29.)
 Trefferlage 0.50 mm rechts, 0.19 mm tief
 Streuwert 1.01, horizontal: 1.17, vertikal: 0.81

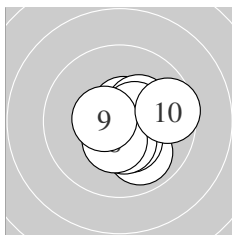
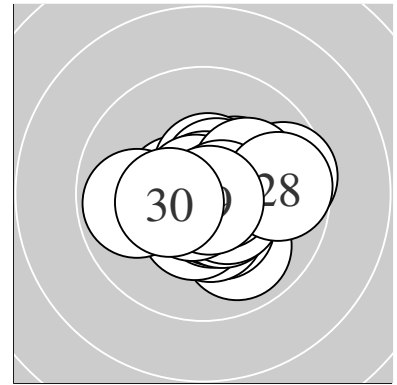

Serie 1:
 10.5 * 9.9 ↘ 10.6 * 10.4 * 10.3 *
 10.5 * 10.4 * 10.4 * 10.5 * 9.6 →
 beste Teiler 87.2 (3.) 105.2 (9.) 113.6 (6.)
 Trefferlage 0.72 mm rechts, 0.41 mm tief
 Streuwert 1.16, horizontal: 1.18, vertikal: 1.15

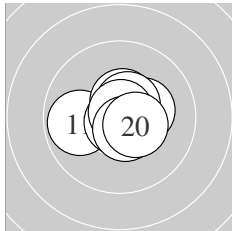

Serie 2:
 9.9 ← 10.8 * 10.7 * 10.5 * 10.8 *
 10.3 * 10.5 * 10.8 * 10.6 * 10.5 *
 beste Teiler 35.1 (18.) 38.5 (15.) 41.2 (12.)
 Trefferlage 0.19 mm rechts, 0.02 mm hoch
 Streuwert 0.92, horizontal: 1.14, vertikal: 0.63

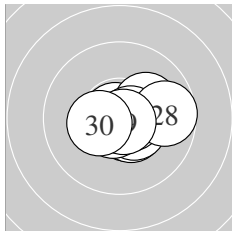

Serie 3:
 10.6 * 10.5 * 10.8 * 10.1 → 10.5 *
 10.7 * 10.6 * 9.7 → 10.8 * 10.4 *
 beste Teiler 36.0 (23.) 36.7 (29.) 68.1 (26.)
 Trefferlage 0.60 mm rechts, 0.19 mm tief
 Streuwert 0.96, horizontal: 1.24, vertikal: 0.54

Unterschrift des Schützen

Ergebnis: **302.1** (287)
 Serien: 99.3 101.6 101.2
 Zähler: 20 9 0 0 1 0 0 0 0 0
 Innenzehner: 14
 weiteste: 1012 (5), 344 (22), 340 (24)
 beste Teiler 8.6 (12.) 38.0 (8.) 60.1 (18.)
 Trefferlage 0.46 mm links, 0.75 mm tief
 Streuwert 1.91, horizontal: 1.90, vertikal: 1.91

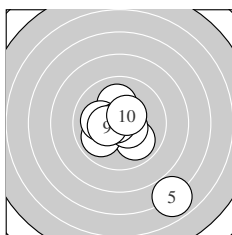
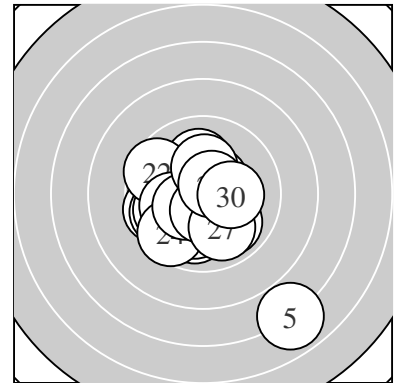

Serie 1:
 9.9 ↘ 9.9 ↙ 10.2 * 10.1 ↑ 6.9 ↘
 10.1 ← 10.5 * 10.8 * 10.4 * 10.5 *
 beste Teiler 38.0 (8.) 107.5 (7.) 118.2 (10.)
 Trefferlage 0.26 mm rechts, 0.74 mm tief
 Streuwert 2.65, horizontal: 2.35, vertikal: 2.93

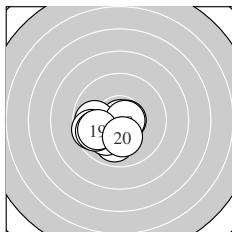

Serie 2:
 10.7 * 10.9 * 9.8 ← 10.0 ↓ 10.0 ↙
 9.6 ← 9.8 ← 10.7 * 9.9 ← 10.2 *
 beste Teiler 8.6 (12.) 60.1 (18.) 74.0 (11.)
 Trefferlage 1.14 mm links, 0.93 mm tief
 Streuwert 1.27, horizontal: 1.55, vertikal: 0.90

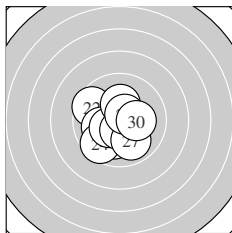

Serie 3:
 10.1 ↓ 9.6 ↖ 10.1 ← 9.6 ↙ 10.4 *
 10.5 * 9.9 ↘ 10.2 * 10.6 * 10.2 *
 beste Teiler 87.8 (29.) 110.0 (26.) 144.0 (25.)
 Trefferlage 0.52 mm links, 0.58 mm tief
 Streuwert 1.57, horizontal: 1.60, vertikal: 1.54

Unterschrift des Schützen

Ergebnis: **298.5** (284)
 Serien: 100.7 101.7 96.1
 Zähler: 16 12 2 0 0 0 0 0 0 0
 Innenzehner: 12
 weiteste: 565 (24), 501 (27), 418 (21)
 beste Teiler 35.3 (15.) 63.5 (7.) 75.9 (13.)
 Trefferlage 0.79 mm links, 0.01 mm hoch
 Streuwert 1.98, horizontal: 1.62, vertikal: 2.28

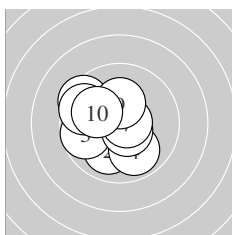
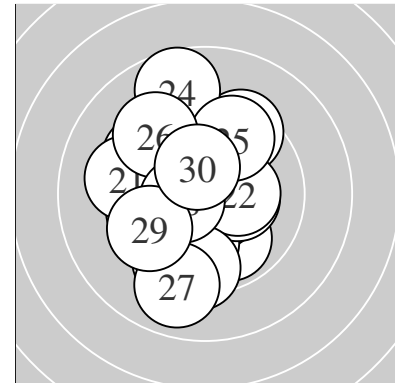

Serie 1:
 10.3 * 10.0 ↙ 9.7 ← 9.9 ↘ 9.5 ↘
 10.6 * 10.7 * 9.6 ↖ 10.3 * 10.1 ↖
 beste Teiler 63.5 (7.) 94.0 (6.) 154.1 (1.)
 Trefferlage 0.96 mm links, 0.13 mm hoch
 Streuwert 1.66, horizontal: 1.71, vertikal: 1.60

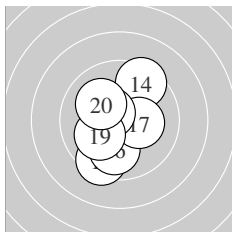

Serie 2:
 9.4 ↙ 10.4 * 10.7 * 9.5 ↗ 10.8 *
 9.9 ↓ 10.3 * 10.5 * 10.1 ↙ 10.1 ↘
 beste Teiler 35.3 (15.) 75.9 (13.) 108.0 (18.)
 Trefferlage 0.29 mm links, 0.39 mm tief
 Streuwert 1.65, horizontal: 1.33, vertikal: 1.92

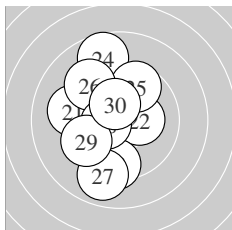

Serie 3:
 9.3 ← 10.3 * 9.4 ↓ 8.7 ↑ 9.7 ↗
 9.3 ↘ 8.9 ↓ 10.5 * 9.6 ↙ 10.4 *
 beste Teiler 125.1 (28.) 146.8 (30.) 173.0 (22.)
 Trefferlage 1.14 mm links, 0.29 mm hoch
 Streuwert 2.60, horizontal: 1.83, vertikal: 3.18

Unterschrift des Schützen

Ergebnis: **304.8** (288)
 Serien: 101.7 100.2 102.9
 Zähler: 19 10 1 0 0 0 0 0 0 0
 Innenzehner: 16
 weiteste: 514 (15), 357 (13), 352 (8)
 beste Teiler 22.8 (24.) 50.9 (3.) 56.8 (23.)
 Trefferlage 0.19 mm rechts, 0.64 mm tief
 Streuwert 1.57, horizontal: 1.77, vertikal: 1.35

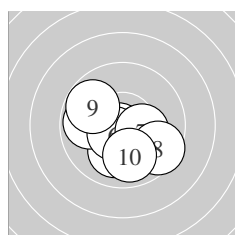
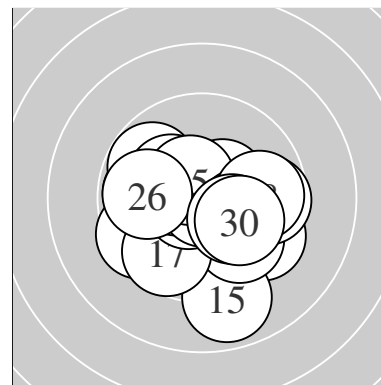

Serie 1:
 10.5 * 10.1 ↙ 10.8 * 9.9 ← 10.3 *
 10.6 * 10.3 * 9.5 ↘ 9.8 ↘ 9.9 ↓
 beste Teiler 50.9 (3.) 100.4 (6.) 101.4 (1.)
 Trefferlage 0.02 mm links, 0.79 mm tief
 Streuwert 1.52, horizontal: 1.78, vertikal: 1.20

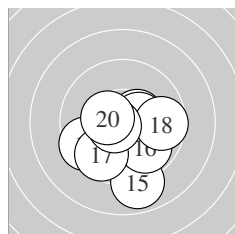

Serie 2:
 10.4 * 10.6 * 9.5 ↙ 10.4 * 8.9 ↓
 9.9 ↘ 9.7 ↙ 9.7 → 10.7 * 10.4 *
 beste Teiler 75.1 (19.) 76.0 (12.) 130.5 (11.)
 Trefferlage 0.21 mm rechts, 1.16 mm tief
 Streuwert 1.83, horizontal: 1.92, vertikal: 1.74

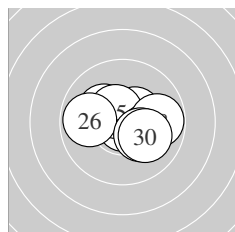

Serie 3:
 10.2 * 10.5 * 10.7 * 10.9 * 10.5 *
 9.9 ← 10.1 ↘ 9.8 → 10.2 * 10.1 ↘
 beste Teiler 22.8 (24.) 56.8 (23.) 106.7 (25.)
 Trefferlage 0.41 mm rechts, 0.01 mm hoch
 Streuwert 1.36, horizontal: 1.76, vertikal: 0.78

Unterschrift des Schützen

Meyton Elektronik

Ergebnis: **307.5** (294)
 Serien: 103.3 102.8 101.4
 Zähler: 24 6 0 0 0 0 0 0 0 0
 Innenzehner: 16
 weiteste: 363 (2), 339 (17), 311 (30)
 beste Teiler 36.6 (1.) 44.0 (16.) 51.0 (11.)
 Trefferlage 0.50 mm links, 0.37 mm tief
 Streuwert 1.34, horizontal: 1.51, vertikal: 1.15

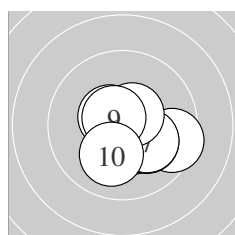
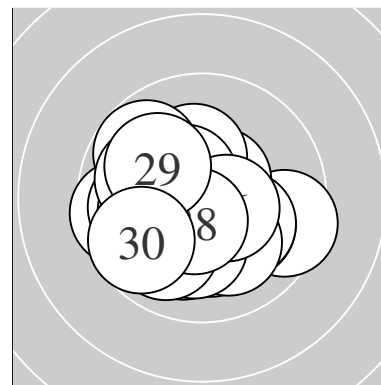

Serie 1:
 10.8 * 9.5 → 10.4 * 10.5 * 10.1 ↘
 10.6 * 10.1 ↘ 10.6 * 10.6 * 10.1 ↓
 beste Teiler 36.6 (1.) 80.8 (9.) 98.4 (6.)
 Trefferlage 0.63 mm rechts, 0.59 mm tief
 Streuwert 1.17, horizontal: 1.36, vertikal: 0.93

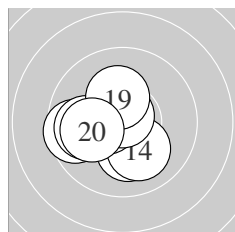

Serie 2:
 10.7 * 10.6 * 10.2 * 10.1 ↘ 10.5 *
 10.8 * 9.6 ← 9.9 ← 10.3 * 10.1 ←
 beste Teiler 44.0 (16.) 51.0 (11.) 97.6 (12.)
 Trefferlage 0.89 mm links, 0.29 mm tief
 Streuwert 1.26, horizontal: 1.40, vertikal: 1.11

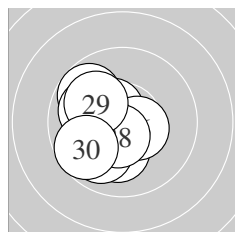

Serie 3:
 10.5 * 9.8 ↖ 10.1 ↓ 9.9 ↙ 10.0 ↖
 10.5 * 10.4 * 10.5 * 10.0 ↖ 9.7 ↙
 beste Teiler 102.1 (28.) 110.6 (26.) 114.0 (21.)
 Trefferlage 1.24 mm links, 0.24 mm tief
 Streuwert 1.29, horizontal: 1.13, vertikal: 1.44

Unterschrift des Schützen

Meyton Elektronik

Ergebnis: **311.8** (295)
 Serien: 102.9 104.7 104.2
 Zähler: 25 5 0 0 0 0 0 0 0 0
 Innenzehner: 22
 weiteste: 343 (4), 295 (23), 281 (16)
 beste Teiler 6.4 (21.) 9.4 (24.) 29.1 (15.)
 Trefferlage 0.10 mm links, 0.50 mm tief
 Streuwert 1.14, horizontal: 1.33, vertikal: 0.90

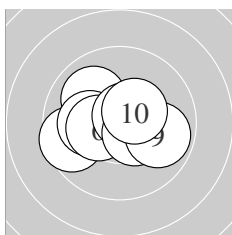
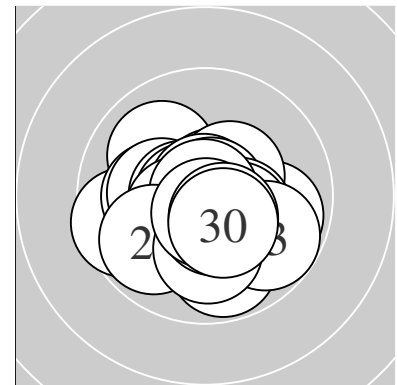

Serie 1:
 10.7 * 10.6 * 10.0 ↘ 9.6 ← 10.1 ←
 10.4 * 10.7 * 10.5 * 9.9 → 10.4 *
 beste Teiler 63.2 (7.) 66.2 (1.) 92.3 (2.)
 Trefferlage 0.49 mm links, 0.03 mm hoch
 Streuwert 1.37, horizontal: 1.75, vertikal: 0.82

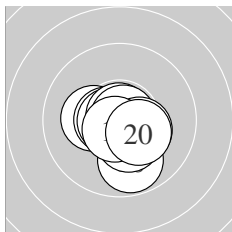

Serie 2:
 10.2 * 10.6 * 10.7 * 10.8 * 10.8 *
 9.8 ↓ 10.4 * 10.4 * 10.7 * 10.3 *
 beste Teiler 29.1 (15.) 30.5 (14.) 66.1 (13.)
 Trefferlage 0.05 mm rechts, 0.56 mm tief
 Streuwert 0.96, horizontal: 1.00, vertikal: 0.92

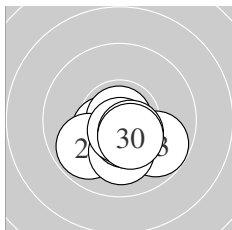

Serie 3:
 10.9 * 10.5 * 9.8 ↘ 10.9 * 9.9 ↙
 10.1 ↓ 10.5 * 10.7 * 10.5 * 10.4 *
 beste Teiler 6.4 (21.) 9.4 (24.) 70.1 (28.)
 Trefferlage 0.12 mm rechts, 0.98 mm tief
 Streuwert 0.98, horizontal: 1.19, vertikal: 0.73

Unterschrift des Schützen

Ergebnis: **312.6** (298)
 Serien: 103.6 103.3 105.7
 Zähler: 28 2 0 0 0 0 0 0 0 0
 Innenzehner: 26
 weiteste: 264 (6), 258 (17), 220 (13)
 beste Teiler 27.3 (16.) 33.3 (22.) 48.1 (29.)
 Trefferlage 0.11 mm rechts, 0.25 mm hoch
 Streuwert 1.04, horizontal: 1.13, vertikal: 0.94

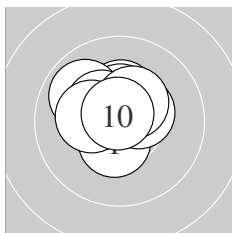
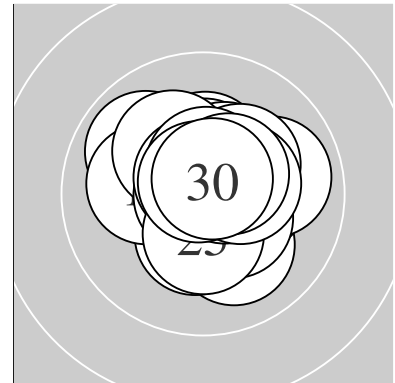

Serie 1:
 10.4 * 10.3 * 10.3 * 10.4 * 10.4 *
 9.9 ↖ 10.4 * 10.3 * 10.4 * 10.8 *
 beste Teiler 48.7 (10.) 126.1 (1.) 128.8 (5.)
 Trefferlage 0.49 mm links, 0.71 mm hoch
 Streuwert 0.97, horizontal: 1.11, vertikal: 0.82

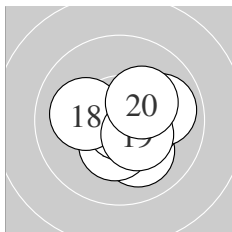

Serie 2:
 10.5 * 10.6 * 10.1 ↘ 10.3 * 10.3 *
 10.8 * 9.9 → 10.1 ← 10.4 * 10.3 *
 beste Teiler 27.3 (16.) 79.5 (12.) 104.6 (11.)
 Trefferlage 0.68 mm rechts, 0.36 mm tief
 Streuwert 1.11, horizontal: 1.25, vertikal: 0.94

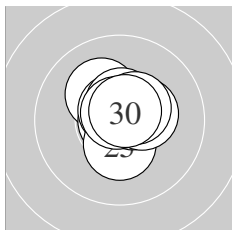

Serie 3:
 10.2 * 10.8 * 10.7 * 10.6 * 10.4 *
 10.6 * 10.4 * 10.5 * 10.8 * 10.7 *
 beste Teiler 33.3 (22.) 48.1 (29.) 65.5 (30.)
 Trefferlage 0.16 mm rechts, 0.42 mm hoch
 Streuwert 0.76, horizontal: 0.73, vertikal: 0.79

Unterschrift des Schützen

Ergebnis: **310.2** (297)
 Serien: 103.4 103.6 103.2
 Zähler: 27 3 0 0 0 0 0 0 0 0
 Innenzehner: 24
 weiteste: 354 (21), 256 (6), 255 (3)
 beste Teiler 41.3 (26.) 44.3 (19.) 44.5 (23.)
 Trefferlage 0.54 mm rechts, 0.33 mm hoch
 Streuwert 1.12, horizontal: 1.29, vertikal: 0.92

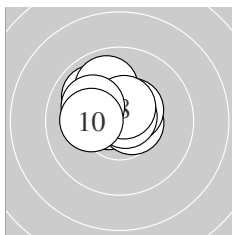
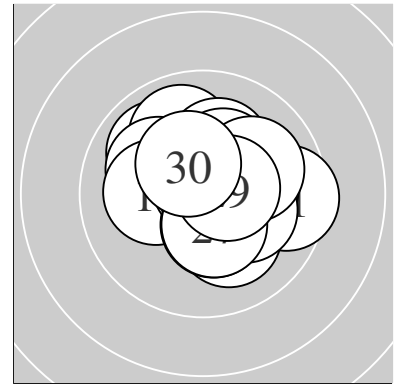

Serie 1:
 10.6 * 10.6 * 9.9 ↘ 10.4 * 10.5 *
 9.9 ↗ 10.7 * 10.5 * 10.1 ↘ 10.2 *
 beste Teiler 52.0 (7.) 82.2 (1.) 89.8 (2.)
 Trefferlage 0.63 mm links, 0.80 mm hoch
 Streuwert 0.99, horizontal: 1.16, vertikal: 0.78

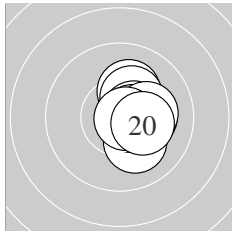

Serie 2:
 10.4 * 10.1 ↘ 10.2 * 10.3 * 10.5 *
 10.6 * 10.2 * 10.2 * 10.8 * 10.3 *
 beste Teiler 44.3 (19.) 91.1 (16.) 104.9 (15.)
 Trefferlage 1.15 mm rechts, 0.23 mm hoch
 Streuwert 0.77, horizontal: 0.50, vertikal: 0.98

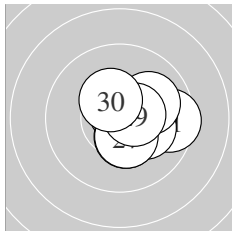

Serie 3:
 9.5 → 10.4 * 10.8 * 10.2 * 10.2 *
 10.8 * 10.4 * 10.0 ↗ 10.5 * 10.4 *
 beste Teiler 41.3 (26.) 44.5 (23.) 105.9 (29.)
 Trefferlage 1.09 mm rechts, 0.02 mm tief
 Streuwert 1.06, horizontal: 1.21, vertikal: 0.88

Unterschrift des Schützen

Ergebnis: **309.3** (296)
 Serien: 104.7 102.4 102.2
 Zähler: 26 4 0 0 0 0 0 0 0 0
 Innenzehner: 21
 weiteste: 301 (26), 283 (24), 267 (22)
 beste Teiler 16.1 (7.) 23.3 (5.) 67.9 (4.)
 Trefferlage 0.09 mm links, 0.13 mm hoch
 Streuwert 1.27, horizontal: 1.25, vertikal: 1.29

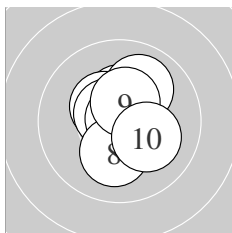
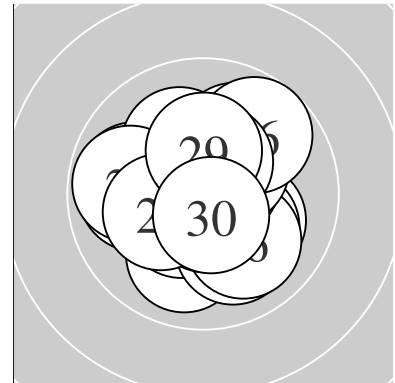

Serie 1:
 10.4 * 10.4 * 10.0 ↗ 10.7 * 10.9 *
 10.6 * 10.9 * 10.2 * 10.4 * 10.2 *
 beste Teiler 16.1 (7.) 23.3 (5.) 67.9 (4.)
 Trefferlage 0.10 mm rechts, 0.36 mm hoch
 Streuwert 1.03, horizontal: 0.83, vertikal: 1.19

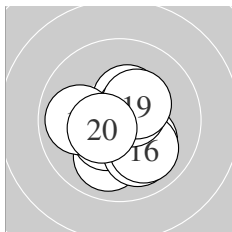

Serie 2:
 10.0 ↓ 10.4 * 10.4 * 10.2 * 10.0 ↘
 10.0 ↘ 9.9 ← 10.6 * 10.4 * 10.5 *
 beste Teiler 90.4 (18.) 124.3 (20.) 129.9 (13.)
 Trefferlage 0.12 mm rechts, 0.60 mm tief
 Streuwert 1.33, horizontal: 1.37, vertikal: 1.30

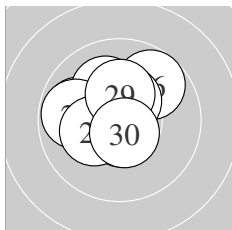

Serie 3:
 10.6 * 9.9 ← 10.1 ↖ 9.8 ← 10.6 *
 9.7 ↗ 10.4 * 10.2 * 10.3 * 10.6 *
 beste Teiler 78.1 (25.) 78.7 (21.) 87.6 (30.)
 Trefferlage 0.51 mm links, 0.64 mm hoch
 Streuwert 1.32, horizontal: 1.49, vertikal: 1.14

Unterschrift des Schützen

Ergebnis: **303.5** (291)
 Serien: 97.5 103.2 102.8
 Zähler: 21 9 0 0 0 0 0 0 0 0
 Innenzehner: 17
 weiteste: 445 (1), 424 (5), 394 (6)
 beste Teiler 31.8 (12.) 67.5 (29.) 78.6 (21.)
 Trefferlage 0.32 mm links, 0.27 mm tief
 Streuwert 1.68, horizontal: 1.50, vertikal: 1.85

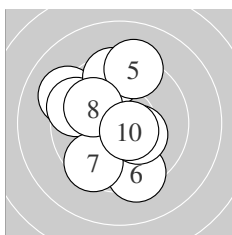
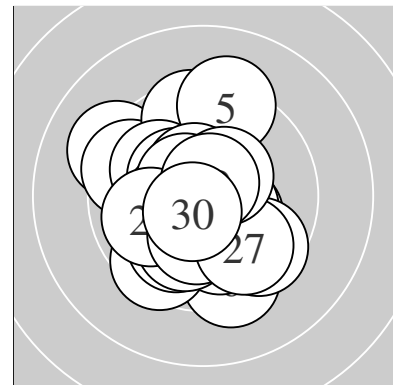

Serie 1:
 9.2 ↘ 10.2 * 9.5 ↘ 9.5 ↑ 9.3 ↑
 9.4 ↓ 9.5 ↙ 10.0 ↘ 10.3 * 10.6 *
 beste Teiler 92.4 (10.) 165.6 (9.) 199.4 (2.)
 Trefferlage 0.87 mm links, 0.54 mm hoch
 Streuwert 2.28, horizontal: 1.95, vertikal: 2.57

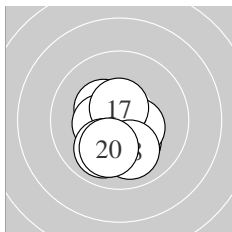

Serie 2:
 10.4 * 10.8 * 10.3 * 10.2 * 10.4 *
 10.4 * 10.6 * 10.0 ↓ 10.0 ↙ 10.1 ↙
 beste Teiler 31.8 (12.) 94.1 (17.) 132.0 (15.)
 Trefferlage 0.16 mm links, 0.90 mm tief
 Streuwert 1.10, horizontal: 0.96, vertikal: 1.22

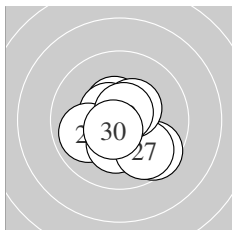

Serie 3:
 10.6 * 9.6 ↘ 10.5 * 10.5 * 9.9 ↙
 10.2 * 9.8 ↘ 10.4 * 10.7 * 10.6 *
 beste Teiler 67.5 (29.) 78.6 (21.) 87.0 (30.)
 Trefferlage 0.05 mm rechts, 0.46 mm tief
 Streuwert 1.37, horizontal: 1.43, vertikal: 1.31

Unterschrift des Schützen

Ergebnis: **307.0** (293)
 Serien: 102.7 103.0 101.3
 Zähler: 23 7 0 0 0 0 0 0 0 0
 Innenzehner: 18
 weiteste: 337 (30), 298 (18), 292 (1)
 beste Teiler 30.3 (11.) 85.2 (12.) 89.8 (16.)
 Trefferlage 0.20 mm links, 0.46 mm tief
 Streuwert 1.35, horizontal: 1.54, vertikal: 1.12

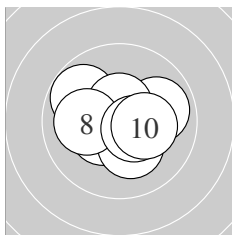
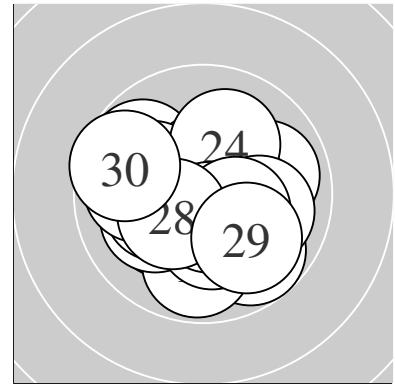

Serie 1:
 9.8 ↖ 10.6 * 10.4 * 10.4 * 9.9 →
 10.5 * 10.2 * 10.1 ← 10.5 * 10.3 *
 beste Teiler 94.1 (2.) 101.0 (6.) 110.4 (9.)
 Trefferlage 0.04 mm rechts, 0.20 mm tief
 Streuwert 1.35, horizontal: 1.60, vertikal: 1.03

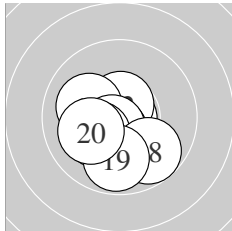

Serie 2:
 10.8 * 10.6 * 10.1 ↖ 10.5 * 10.5 *
 10.6 * 10.2 * 9.8 ↘ 9.8 ↓ 10.1 ←
 beste Teiler 30.3 (11.) 85.2 (12.) 89.8 (16.)
 Trefferlage 0.47 mm links, 0.83 mm tief
 Streuwert 1.16, horizontal: 1.18, vertikal: 1.15

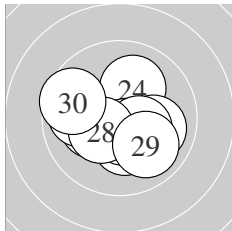

Serie 3:
 10.2 * 9.9 ← 10.3 * 10.1 ↗ 10.0 →
 10.6 * 10.3 * 10.4 * 9.9 ↘ 9.6 ↖
 beste Teiler 98.7 (26.) 148.1 (28.) 151.3 (27.)
 Trefferlage 0.19 mm links, 0.36 mm tief
 Streuwert 1.58, horizontal: 1.90, vertikal: 1.19

Unterschrift des Schützen

Ergebnis: **293.2** (279)
 Serien: 100.9 94.2 98.1
 Zähler: 11 17 2 0 0 0 0 0 0 0
 Innenzehner: 7
 weiteste: 686 (19), 638 (17), 493 (20)
 beste Teiler 54.7 (6.) 59.6 (21.) 148.8 (10.)
 Trefferlage 0.62 mm rechts, 0.87 mm hoch
 Streuwert 2.22, horizontal: 2.23, vertikal: 2.22

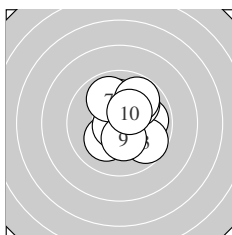
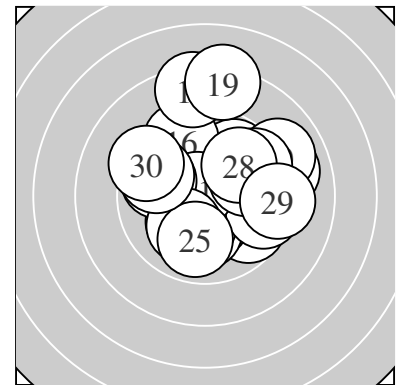

Serie 1:
 9.9 → 10.1 ↑ 9.7 ↘ 10.2 * 9.9 ↗
 10.7 * 9.9 ↘ 9.8 ↗ 10.3 * 10.4 *
 beste Teiler 54.7 (6.) 148.8 (10.) 154.5 (9.)
 Trefferlage 0.70 mm rechts, 0.50 mm hoch
 Streuwert 1.57, horizontal: 1.44, vertikal: 1.69

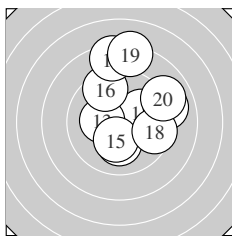

Serie 2:
 10.0 → 9.0 → 10.3 * 10.1 ↓ 10.2 *
 9.5 ↘ 8.4 ↑ 9.5 → 8.2 ↑ 9.0 →
 beste Teiler 174.8 (13.) 176.7 (15.) 210.0 (14.)
 Trefferlage 1.12 mm rechts, 1.67 mm hoch
 Streuwert 2.76, horizontal: 2.37, vertikal: 3.09

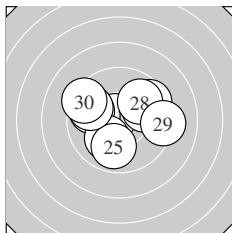

Serie 3:
 10.7 * 9.9 → 9.8 ↖ 10.1 ↙ 9.9 ↓
 9.6 ↗ 9.7 ↖ 9.9 ↗ 9.2 → 9.3 ↖
 beste Teiler 59.6 (21.) 217.5 (24.) 265.6 (25.)
 Trefferlage 0.03 mm rechts, 0.44 mm hoch
 Streuwert 2.24, horizontal: 2.75, vertikal: 1.56

Unterschrift des Schützen

Ergebnis: **310.5** (299)
 Serien: 102.5 103.1 104.9
 Zähler: 29 1 0 0 0 0 0 0 0 0
 Innenzehner: 19
 weiteste: 363 (30), 241 (11), 240 (10)
 beste Teiler 14.8 (26.) 18.4 (14.) 38.2 (28.)
 Trefferlage 0.59 mm rechts, 0.55 mm tief
 Streuwert 1.08, horizontal: 1.13, vertikal: 1.03

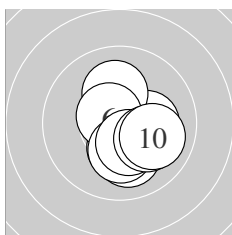
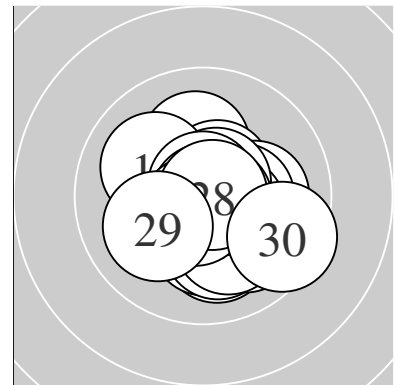

Serie 1:
 10.3 * 10.5 * 10.2 * 10.1 ↑ 10.1 ↓
 10.6 * 10.2 * 10.4 * 10.1 ↘ 10.0 ↘
 beste Teiler 86.8 (6.) 122.5 (2.) 145.4 (8.)
 Trefferlage 0.68 mm rechts, 0.74 mm tief
 Streuwert 1.13, horizontal: 0.99, vertikal: 1.26

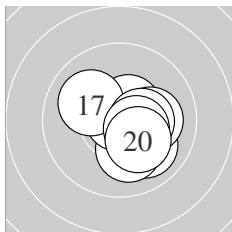

Serie 2:
 10.0 ↘ 10.1 ↓ 10.5 * 10.9 * 10.5 *
 10.1 → 10.0 ↖ 10.4 * 10.4 * 10.2 *
 beste Teiler 18.4 (14.) 103.4 (15.) 125.7 (13.)
 Trefferlage 0.79 mm rechts, 0.40 mm tief
 Streuwert 1.10, horizontal: 1.15, vertikal: 1.04

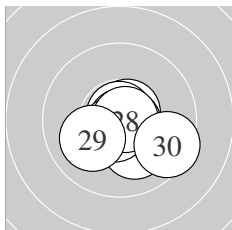

Serie 3:
 10.6 * 10.7 * 10.1 ↓ 10.7 * 10.8 *
 10.9 * 10.7 * 10.8 * 10.1 ↙ 9.5 ↘
 beste Teiler 14.8 (26.) 38.2 (28.) 39.0 (25.)
 Trefferlage 0.31 mm rechts, 0.53 mm tief
 Streuwert 1.08, horizontal: 1.30, vertikal: 0.82

Unterschrift des Schützen

Ergebnis: **300.1** (284)
 Serien: 99.6 100.0 100.5
 Zähler: 17 10 3 0 0 0 0 0 0 0
 Innenzehner: 13
 weiteste: 677 (10), 553 (12), 507 (6)
 beste Teiler 23.4 (30.) 36.8 (14.) 50.6 (5.)
 Trefferlage 0.50 mm rechts, 0.16 mm hoch
 Streuwert 2.00, horizontal: 2.46, vertikal: 1.39

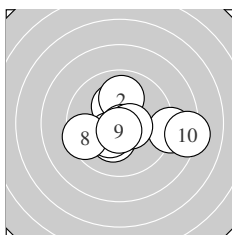
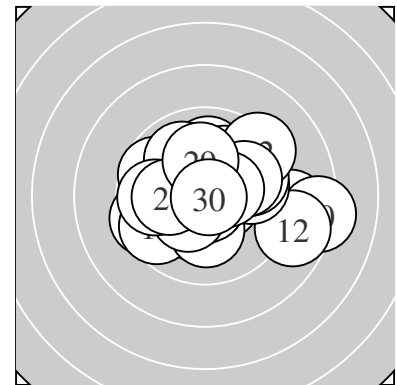

Serie 1:
 10.3 * 10.0 ↑ 10.3 * 10.4 * 10.8 *
 8.9 → 10.5 * 9.5 ← 10.7 * 8.2 →
 beste Teiler 50.6 (5.) 71.2 (9.) 105.9 (7.)
 Trefferlage 0.76 mm rechts, 0.31 mm tief
 Streuwert 2.29, horizontal: 2.96, vertikal: 1.33

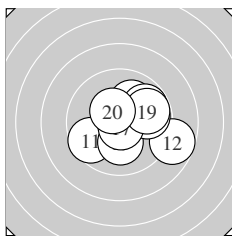

Serie 2:
 9.6 ← 8.7 → 10.2 * 10.8 * 10.1 ↗
 9.8 → 10.8 * 9.8 ↗ 9.8 → 10.4 *
 beste Teiler 36.8 (14.) 50.6 (17.) 131.2 (20.)
 Trefferlage 1.12 mm rechts, 0.00 mm
 Streuwert 1.90, horizontal: 2.24, vertikal: 1.48

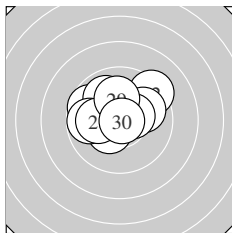

Serie 3:
 9.7 ↖ 9.3 ↗ 10.4 * 9.9 ↘ 9.9 →
 9.8 ← 10.4 * 10.1 ← 10.1 ↑ 10.9 *
 beste Teiler 23.4 (30.) 131.2 (27.) 145.7 (23.)
 Trefferlage 0.37 mm links, 0.83 mm hoch
 Streuwert 1.72, horizontal: 2.10, vertikal: 1.21

Unterschrift des Schützen

Ergebnis: **295.0** (282)
 Serien: 99.0 98.0 98.0
 Zähler: 16 10 4 0 0 0 0 0 0 0
 Innenzehner: 8
 weiteste: 636 (21), 574 (19), 548 (26)
 beste Teiler 26.4 (20.) 88.7 (7.) 94.5 (10.)
 Trefferlage 0.72 mm rechts, 1.14 mm tief
 Streuwert 2.05, horizontal: 2.53, vertikal: 1.41

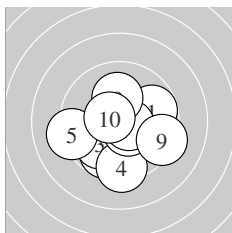
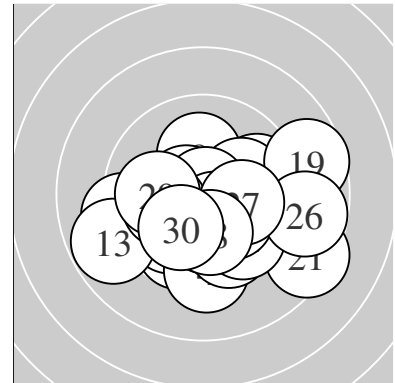

Serie 1:
 9.8 → 9.7 ↙ 9.9 ↘ 9.3 ↓ 9.2 ←
 10.5 * 10.6 * 10.1 ↑ 9.3 ↘ 10.6 *
 beste Teiler 88.7 (7.) 94.5 (10.) 112.5 (6.)
 Trefferlage 0.00 mm , 0.94 mm tief
 Streuwert 2.04, horizontal: 2.27, vertikal: 1.79

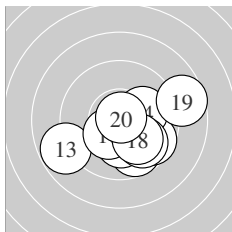

Serie 2:
 9.7 ↘ 9.6 ↘ 8.8 ↙ 10.1 → 10.2 *
 10.3 * 9.8 ↘ 10.0 ↘ 8.7 → 10.8 *
 beste Teiler 26.4 (20.) 154.3 (16.) 196.4 (15.)
 Trefferlage 0.97 mm rechts, 1.10 mm tief
 Streuwert 2.16, horizontal: 2.67, vertikal: 1.48

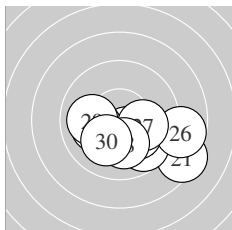

Serie 3:
 8.4 ↘ 9.7 ↘ 10.5 * 10.2 * 10.1 ←
 8.8 → 10.1 → 10.1 ↓ 10.0 ← 10.1 ↙
 beste Teiler 123.6 (23.) 193.9 (24.) 207.5 (28.)
 Trefferlage 1.19 mm rechts, 1.37 mm tief
 Streuwert 2.05, horizontal: 2.74, vertikal: 0.96

Unterschrift des Schützen

Ergebnis: **301.2** (290)
 Serien: 100.7 101.9 98.6
 Zähler: 20 10 0 0 0 0 0 0 0 0
 Innenzehner: 10
 weiteste: 471 (29), 471 (30), 410 (9)
 beste Teiler 34.0 (14.) 84.8 (2.) 101.6 (16.)
 Trefferlage 0.49 mm rechts, 0.55 mm hoch
 Streuwert 1.72, horizontal: 2.00, vertikal: 1.38

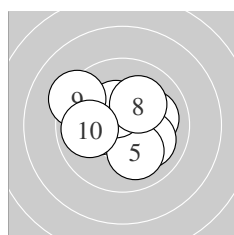
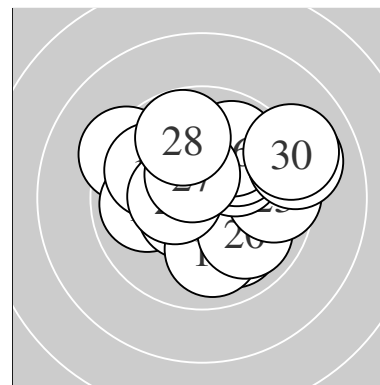

Serie 1:
 10.1 → 10.6 * 10.1 ↘ 10.3 * 10.1 ↓
 9.8 ↖ 10.4 * 10.1 ↗ 9.3 ↖ 9.9 ←
 beste Teiler 84.8 (2.) 136.6 (7.) 174.1 (4.)
 Trefferlage 0.45 mm links, 0.39 mm hoch
 Streuwert 1.72, horizontal: 2.07, vertikal: 1.28

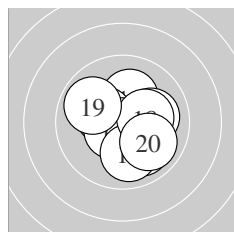

Serie 2:
 10.0 ↘ 10.2 * 10.3 * 10.8 * 10.1 →
 10.5 * 10.0 ↓ 10.2 * 9.9 ↖ 9.9 ↘
 beste Teiler 34.0 (14.) 101.6 (16.) 152.5 (13.)
 Trefferlage 0.39 mm rechts, 0.24 mm tief
 Streuwert 1.48, horizontal: 1.54, vertikal: 1.41

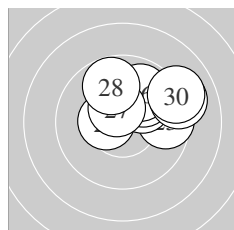

Serie 3:
 10.4 * 10.1 ↗ 9.6 → 10.1 ↗ 10.0 ↗
 9.9 ↗ 10.5 * 9.8 ↖ 9.1 → 9.1 →
 beste Teiler 119.2 (27.) 127.1 (21.) 208.2 (24.)
 Trefferlage 1.54 mm rechts, 1.51 mm hoch
 Streuwert 1.55, horizontal: 2.01, vertikal: 0.89

Unterschrift des Schützen

Meyton Elektronik

Ergebnis: **300.7** (288)
 Serien: 100.6 99.6 100.5
 Zähler: 18 12 0 0 0 0 0 0 0 0
 Innenzehner: 12
 weiteste: 479 (2), 443 (15), 414 (26)
 beste Teiler 66.6 (20.) 78.7 (1.) 88.2 (30.)
 Trefferlage 0.29 mm links, 1.18 mm hoch
 Streuwert 1.59, horizontal: 1.87, vertikal: 1.25

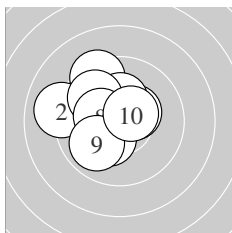
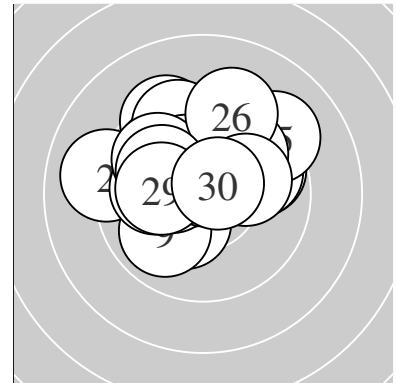

Serie 1:
 10.6 * 9.0 ← 9.4 ↗ 10.4 * 10.3 *
 10.3 * 9.9 ↘ 10.3 * 9.9 ↙ 10.5 *
 beste Teiler 78.7 (1.) 109.5 (10.) 137.3 (4.)
 Trefferlage 1.11 mm links, 0.71 mm hoch
 Streuwert 1.62, horizontal: 1.70, vertikal: 1.54

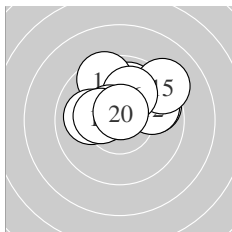

Serie 2:
 9.7 → 9.8 → 9.9 ↑ 9.5 ↗ 9.2 ↗
 10.0 ↑ 10.5 * 10.0 ← 10.3 * 10.7 *
 beste Teiler 66.6 (20.) 101.4 (17.) 156.7 (19.)
 Trefferlage 0.46 mm rechts, 1.48 mm hoch
 Streuwert 1.61, horizontal: 1.99, vertikal: 1.10

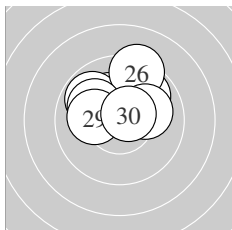

Serie 3:
 10.4 * 9.9 ↗ 10.2 * 10.1 ← 9.8 ↘
 9.3 ↑ 10.0 ↘ 10.1 → 10.1 ← 10.6 *
 beste Teiler 88.2 (30.) 128.8 (21.) 181.5 (23.)
 Trefferlage 0.23 mm links, 1.34 mm hoch
 Streuwert 1.45, horizontal: 1.76, vertikal: 1.06

Unterschrift des Schützen

Ergebnis: **303.9** (291)
 Serien: 101.1 102.1 100.7
 Zähler: 21 9 0 0 0 0 0 0 0 0
 Innenzehner: 15
 weiteste: 403 (28), 389 (7), 318 (27)
 beste Teiler 60.2 (12.) 75.8 (21.) 84.9 (30.)
 Trefferlage 0.13 mm links, 0.59 mm hoch
 Streuwert 1.55, horizontal: 1.66, vertikal: 1.43

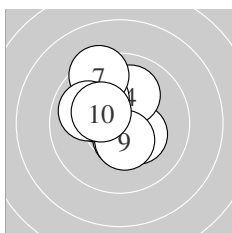
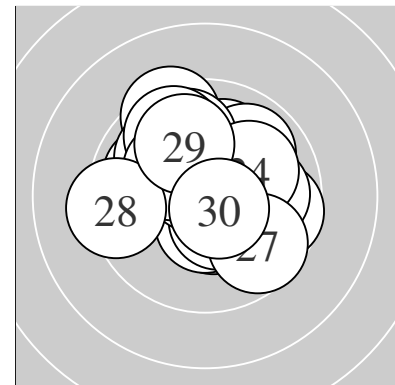

Serie 1:
 10.5 * 10.2 * 10.3 * 10.1 ↗ 10.0 ↘
 10.0 ↘ 9.4 ↘ 9.9 ↖ 10.4 * 10.3 *
 beste Teiler 109.2 (1.) 132.5 (9.) 157.6 (3.)
 Trefferlage 0.73 mm links, 0.86 mm hoch
 Streuwert 1.42, horizontal: 1.28, vertikal: 1.55

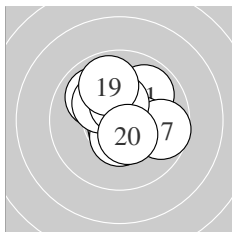

Serie 2:
 9.9 ↗ 10.7 * 9.9 ↘ 10.3 * 10.5 *
 10.2 * 9.7 → 10.5 * 9.9 ↗ 10.5 *
 beste Teiler 60.2 (12.) 121.0 (15.) 123.0 (18.)
 Trefferlage 0.30 mm rechts, 0.46 mm hoch
 Streuwert 1.47, horizontal: 1.52, vertikal: 1.41

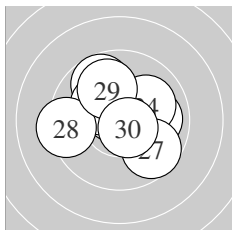

Serie 3:
 10.7 * 10.5 * 10.0 → 10.0 ↗ 9.7 ↘
 10.2 * 9.7 ↘ 9.3 ← 10.0 ↗ 10.6 *
 beste Teiler 75.8 (21.) 84.9 (30.) 112.3 (22.)
 Trefferlage 0.02 mm rechts, 0.44 mm hoch
 Streuwert 1.78, horizontal: 2.06, vertikal: 1.45

Unterschrift des Schützen

Ergebnis: **298.7** (284)
 Serien: 98.8 101.7 98.2
 Zähler: 14 16 0 0 0 0 0 0 0 0
 Innenzehner: 9
 weiteste: 486 (10), 387 (5), 363 (23)
 beste Teiler 55.9 (16.) 60.5 (15.) 87.7 (24.)
 Trefferlage 0.70 mm rechts, 0.35 mm hoch
 Streuwert 1.84, horizontal: 1.84, vertikal: 1.85

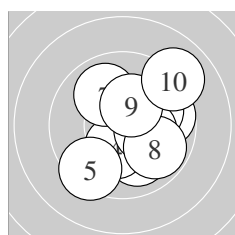
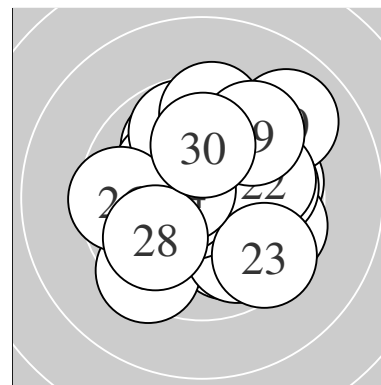

Serie 1:
 9.7 → 10.0 ↗ 10.0 ↘ 10.3 * 9.4 ↙
 10.3 * 10.0 ↖ 9.8 ↘ 10.3 * 9.0 ↗
 beste Teiler 154.0 (9.) 165.1 (4.) 167.6 (6.)
 Trefferlage 1.02 mm rechts, 0.02 mm tief
 Streuwert 1.98, horizontal: 1.89, vertikal: 2.06

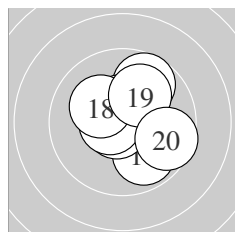

Serie 2:
 9.7 ↗ 9.8 ↘ 10.5 * 9.9 ↘ 10.7 *
 10.7 * 10.6 * 10.2 * 10.0 ↗ 9.6 ↘
 beste Teiler 55.9 (16.) 60.5 (15.) 88.3 (17.)
 Trefferlage 0.75 mm rechts, 0.21 mm hoch
 Streuwert 1.52, horizontal: 1.51, vertikal: 1.53

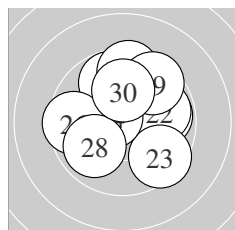

Serie 3:
 9.8 → 9.9 → 9.5 ↘ 10.6 * 9.8 ↙
 9.6 ← 9.5 ↑ 9.9 ↗ 9.6 ↗ 10.0 ↑
 beste Teiler 87.7 (24.) 226.0 (30.) 263.1 (28.)
 Trefferlage 0.34 mm rechts, 0.87 mm hoch
 Streuwert 2.09, horizontal: 2.18, vertikal: 1.99

Unterschrift des Schützen

Meyton Elektronik

Ergebnis: **302.9** (290)
 Serien: 103.0 98.7 101.2
 Zähler: 21 8 1 0 0 0 0 0 0 0
 Innenzehner: 16
 weiteste: 502 (11), 376 (14), 362 (26)
 beste Teiler 18.7 (30.) 62.3 (18.) 67.2 (4.)
 Trefferlage 0.48 mm links, 0.18 mm hoch
 Streuwert 1.66, horizontal: 1.88, vertikal: 1.42

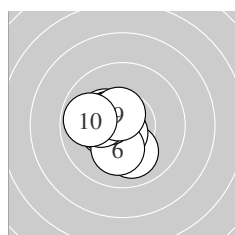
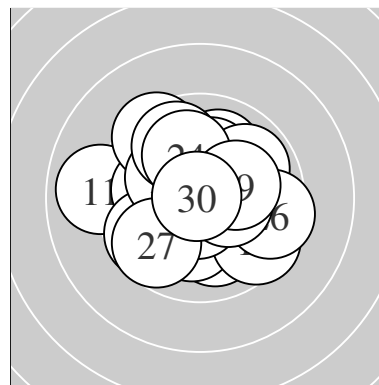

Serie 1:
 10.4 * 10.3 * 10.0 ↘ 10.7 * 10.3 *
 10.2 * 10.4 * 10.2 * 10.6 * 9.9 ←
 beste Teiler 67.2 (4.) 98.6 (9.) 131.9 (7.)
 Trefferlage 1.02 mm links, 0.19 mm tief
 Streuwert 1.05, horizontal: 1.00, vertikal: 1.10

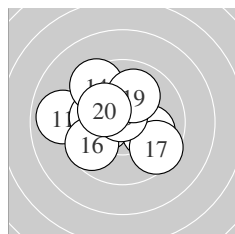

Serie 2:
 8.9 ← 10.3 * 10.0 ← 9.4 ↖ 10.0 →
 9.7 ↙ 9.5 ↘ 10.7 * 10.0 ↗ 10.2 *
 beste Teiler 62.3 (18.) 157.1 (12.) 184.4 (20.)
 Trefferlage 0.93 mm links, 0.28 mm hoch
 Streuwert 2.04, horizontal: 2.38, vertikal: 1.62

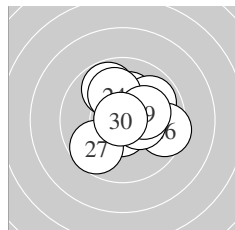

Serie 3:
 9.8 ↖ 10.2 * 9.9 ↗ 10.0 ↗ 10.6 *
 9.5 → 9.7 ↙ 10.4 * 10.2 * 10.9 *
 beste Teiler 18.7 (30.) 83.0 (25.) 143.6 (28.)
 Trefferlage 0.51 mm rechts, 0.46 mm hoch
 Streuwert 1.65, horizontal: 1.74, vertikal: 1.55

Unterschrift des Schützen

Meyton Elektronik

Ergebnis: **302.0** (288)
 Serien: 101.5 97.7 102.8
 Zähler: 18 12 0 0 0 0 0 0 0 0
 Innenzehner: 16
 weiteste: 467 (11), 431 (16), 414 (18)
 beste Teiler 52.4 (23.) 67.6 (30.) 75.9 (7.)
 Trefferlage 0.85 mm rechts, 0.56 mm tief
 Streuwert 1.67, horizontal: 1.98, vertikal: 1.27

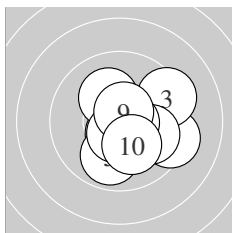
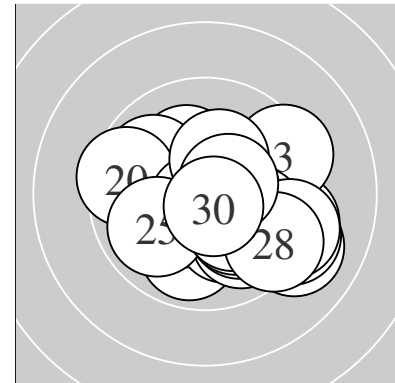

Serie 1:
 9.3 ➤ 10.6 * 9.4 ➤ 10.2 * 9.9 ↓
 10.0 ➤ 10.7 * 10.6 * 10.6 * 10.2 *
 beste Teiler 75.9 (7.) 76.5 (9.) 92.8 (8.)
 Trefferlage 0.94 mm rechts, 0.42 mm tief
 Streuwert 1.58, horizontal: 1.71, vertikal: 1.44

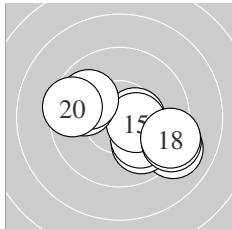

Serie 2:
 9.1 ↘ 9.9 ↘ 10.5 * 10.1 ↘ 10.4 *
 9.2 ➤ 9.8 ← 9.3 ➤ 9.9 ↖ 9.5 ←
 beste Teiler 117.0 (13.) 130.6 (15.) 222.0 (14.)
 Trefferlage 0.88 mm rechts, 0.69 mm tief
 Streuwert 2.21, horizontal: 2.81, vertikal: 1.36

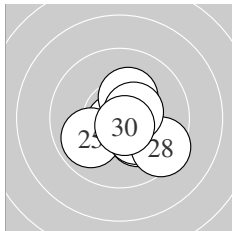

Serie 3:
 10.3 * 10.2 * 10.7 * 10.6 * 9.9 ↙
 10.2 * 10.3 * 9.4 ↘ 10.5 * 10.7 *
 beste Teiler 52.4 (23.) 67.6 (30.) 90.3 (24.)
 Trefferlage 0.74 mm rechts, 0.58 mm tief
 Streuwert 1.24, horizontal: 1.34, vertikal: 1.12

Unterschrift des Schützen

Ergebnis: **305.2** (292)
 Serien: 103.0 101.9 100.3
 Zähler: 22 8 0 0 0 0 0 0 0 0
 Innenzehner: 18
 weiteste: 476 (24), 332 (30), 310 (15)
 beste Teiler 42.1 (26.) 45.6 (10.) 53.9 (2.)
 Trefferlage 0.20 mm rechts, 0.15 mm tief
 Streuwert 1.55, horizontal: 1.83, vertikal: 1.20

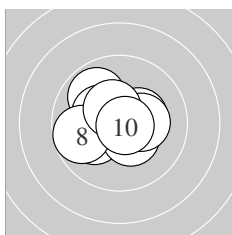
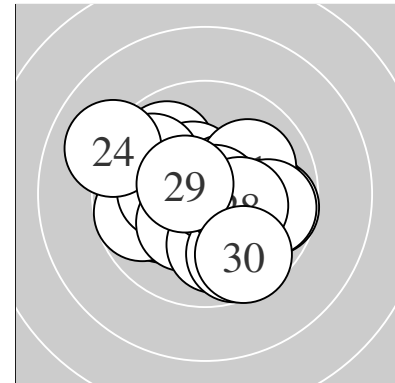

Serie 1:
 10.1 ↙ 10.7 * 9.9 ↘ 10.4 * 10.3 *
 10.3 * 10.3 * 9.7 ↙ 10.5 * 10.8 *
 beste Teiler 45.6 (10.) 53.9 (2.) 124.7 (9.)
 Trefferlage 0.39 mm links, 0.09 mm hoch
 Streuwert 1.32, horizontal: 1.57, vertikal: 1.01

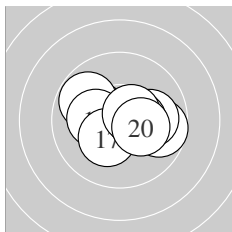

Serie 2:
 10.4 * 10.3 * 9.8 ↘ 10.2 * 9.7 →
 10.0 → 10.3 * 10.4 * 10.5 * 10.3 *
 beste Teiler 103.8 (19.) 137.0 (18.) 142.2 (11.)
 Trefferlage 0.38 mm rechts, 0.00 mm
 Streuwert 1.46, horizontal: 1.92, vertikal: 0.77

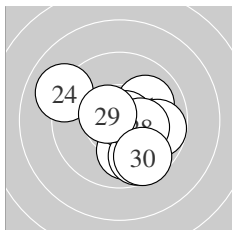

Serie 3:
 10.0 ↗ 10.6 * 9.8 → 9.0 ↘ 10.0 ↓
 10.8 * 9.7 ↘ 10.3 * 10.5 * 9.6 ↘
 beste Teiler 42.1 (26.) 78.1 (22.) 103.7 (29.)
 Trefferlage 0.60 mm rechts, 0.55 mm tief
 Streuwert 1.85, horizontal: 2.01, vertikal: 1.67

Unterschrift des Schützen

Ergebnis: **305.3** (292)
 Serien: 102.0 100.0 103.3
 Zähler: 22 8 0 0 0 0 0 0 0 0
 Innenzehner: 19
 weiteste: 459 (14), 384 (19), 354 (15)
 beste Teiler 3.6 (3.) 69.3 (9.) 72.2 (23.)
 Trefferlage 0.12 mm links, 0.07 mm tief
 Streuwert 1.58, horizontal: 1.23, vertikal: 1.86

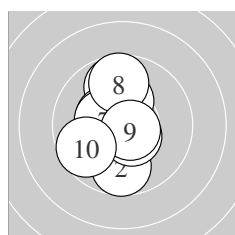
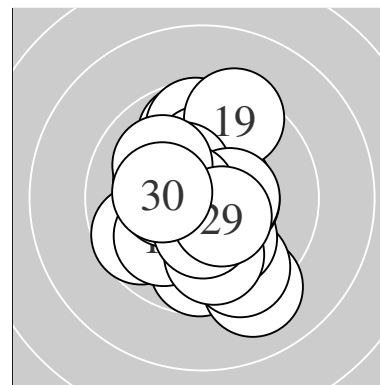

Serie 1:
 9.8 ↑ 9.7 ↓ 10.9 * 10.4 * 10.5 *
 10.2 * 10.4 * 9.7 ↑ 10.7 * 9.7 ↙
 beste Teiler 3.6 (3.) 69.3 (9.) 107.1 (5.)
 Trefferlage 0.50 mm links, 0.29 mm hoch
 Streuwert 1.56, horizontal: 1.04, vertikal: 1.94

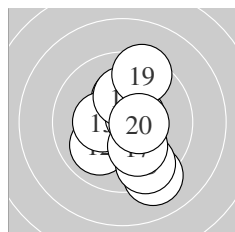

Serie 2:
 10.3 * 10.0 ↘ 10.4 * 9.1 ↘ 9.5 ↘
 10.5 * 10.1 ↘ 10.2 * 9.4 ↗ 10.5 *
 beste Teiler 102.4 (16.) 123.4 (20.) 150.0 (13.)
 Trefferlage 0.54 mm rechts, 0.30 mm tief
 Streuwert 1.92, horizontal: 1.34, vertikal: 2.36

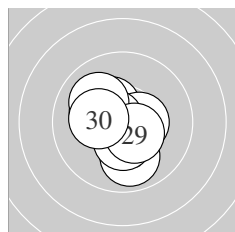

Serie 3:
 10.4 * 10.5 * 10.7 * 10.5 * 10.2 *
 9.9 ↓ 10.0 ↖ 10.4 * 10.5 * 10.2 *
 beste Teiler 72.2 (23.) 113.0 (24.) 120.9 (29.)
 Trefferlage 0.41 mm links, 0.21 mm tief
 Streuwert 1.19, horizontal: 1.14, vertikal: 1.25

Unterschrift des Schützen

Meyton Elektronik

Ergebnis: **303.9** (292)
 Serien: 101.4 101.5 101.0
 Zähler: 22 8 0 0 0 0 0 0 0 0
 Innenzehner: 16
 weiteste: 383 (26), 381 (12), 367 (20)
 beste Teiler 59.3 (30.) 64.2 (18.) 89.3 (13.)
 Trefferlage 0.20 mm rechts, 0.16 mm hoch
 Streuwert 1.61, horizontal: 1.64, vertikal: 1.57

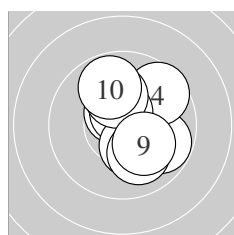
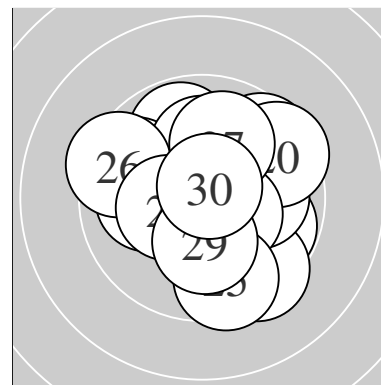

Serie 1:
 10.5 * 10.5 * 9.8 ↘ 9.6 ↗ 10.6 *
 10.3 * 10.1 ↑ 10.0 ↘ 10.2 * 9.8 ↑
 beste Teiler 92.5 (5.) 102.1 (2.) 102.9 (1.)
 Trefferlage 0.63 mm rechts, 0.38 mm hoch
 Streuwert 1.51, horizontal: 1.26, vertikal: 1.72

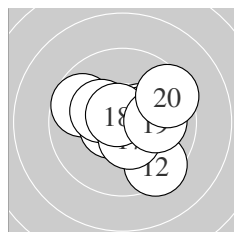

Serie 2:
 9.7 ↖ 9.4 ↘ 10.6 * 10.3 * 10.4 *
 10.4 * 10.5 * 10.7 * 10.0 → 9.5 ↗
 beste Teiler 64.2 (18.) 89.3 (13.) 120.8 (17.)
 Trefferlage 0.52 mm rechts, 0.07 mm hoch
 Streuwert 1.65, horizontal: 1.91, vertikal: 1.35

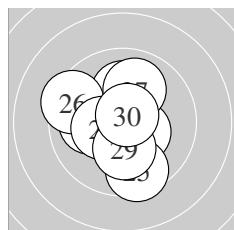

Serie 3:
 10.0 ← 10.4 * 10.3 * 10.1 ↑ 9.5 ↓
 9.4 ↖ 10.0 ↑ 10.4 * 10.2 * 10.7 *
 beste Teiler 59.3 (30.) 137.5 (22.) 149.0 (28.)
 Trefferlage 0.53 mm links, 0.03 mm hoch
 Streuwert 1.68, horizontal: 1.59, vertikal: 1.76

Unterschrift des Schützen

Meyton Elektronik

Ergebnis: **306.2** (293)
 Serien: 102.1 103.1 101.0
 Zähler: 23 7 0 0 0 0 0 0 0 0
 Innenzehner: 18
 weiteste: 445 (28), 419 (17), 416 (7)
 beste Teiler 32.5 (15.) 41.1 (5.) 46.0 (22.)
 Trefferlage 0.55 mm rechts, 0.14 mm hoch
 Streuwert 1.52, horizontal: 1.76, vertikal: 1.24

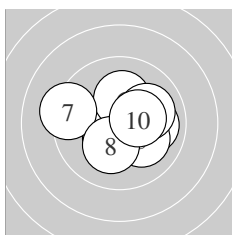
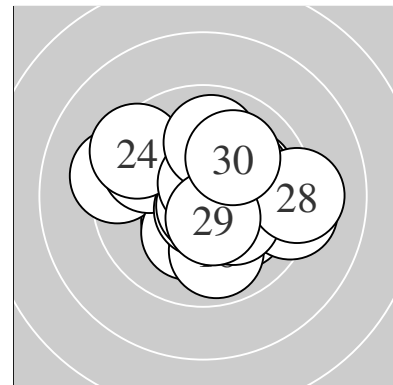

Serie 1:
 10.0 → 10.7 * 10.1 ↘ 10.4 * 10.8 *
 10.2 * 9.3 ← 10.2 * 10.0 → 10.4 *
 beste Teiler 41.1 (5.) 66.0 (2.) 138.7 (4.)
 Trefferlage 0.29 mm rechts, 0.01 mm hoch
 Streuwert 1.57, horizontal: 1.91, vertikal: 1.13

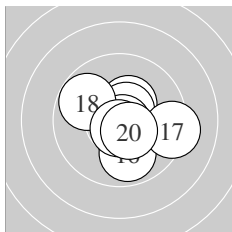

Serie 2:
 10.5 * 10.6 * 10.4 * 10.6 * 10.8 *
 9.9 ↓ 9.3 → 9.8 ↖ 10.7 * 10.5 *
 beste Teiler 32.5 (15.) 64.4 (19.) 84.0 (12.)
 Trefferlage 0.54 mm rechts, 0.28 mm tief
 Streuwert 1.42, horizontal: 1.60, vertikal: 1.21

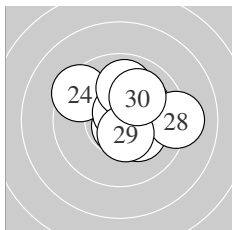

Serie 3:
 10.2 * 10.8 * 10.1 ↗ 9.4 ↖ 10.2 *
 10.7 * 9.9 ↑ 9.2 → 10.5 * 10.0 ↗
 beste Teiler 46.0 (22.) 61.8 (26.) 114.1 (29.)
 Trefferlage 0.83 mm rechts, 0.69 mm hoch
 Streuwert 1.62, horizontal: 1.89, vertikal: 1.29

Unterschrift des Schützen

Ergebnis: **290.3** (278)
 Serien: 101.1 91.2 98.0
 Zähler: 18 10 1 0 0 0 0 0 0 0
 Innenzehner: 14
 weiteste: 2567 (15), 512 (19), 463 (5)
 beste Teiler 44.2 (14.) 54.0 (11.) 87.3 (6.)
 Trefferlage 0.13 mm rechts, 0.50 mm tief
 Streuwert 3.85, horizontal: 2.71, vertikal: 4.72

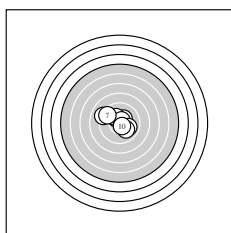
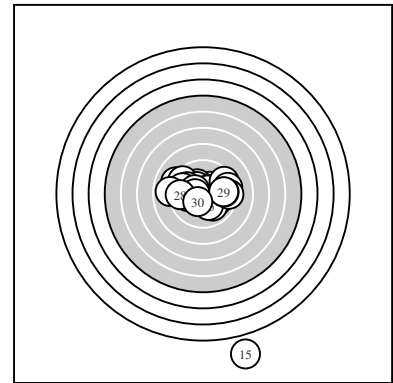

Serie 1:
 10.3 * 10.6 * 10.3 * 10.2 * 9.1 ↖
 10.6 * 9.4 ↖ 10.0 ↘ 10.0 ↘ 10.6 *
 beste Teiler 87.3 (6.) 95.9 (2.) 96.6 (10.)
 Trefferlage 0.27 mm links, 0.62 mm hoch
 Streuwert 1.72, horizontal: 2.07, vertikal: 1.28

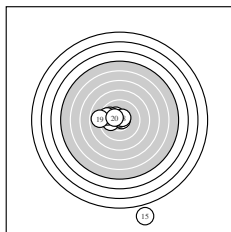

Serie 2:
 10.7 * 10.3 * 10.0 ← 10.8 * 0.0 ↓
 9.9 ↖ 9.6 ← 10.6 * 8.9 ← 10.4 *
 beste Teiler 44.2 (14.) 54.0 (11.) 90.6 (18.)
 Trefferlage 0.75 mm links, 1.99 mm tief
 Streuwert 6.10, horizontal: 3.14, vertikal: 8.04

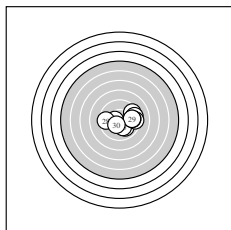

Serie 3:
 10.5 * 9.4 ↗ 10.0 ↘ 9.4 → 10.2 *
 9.3 → 9.6 → 9.5 ← 9.7 → 10.4 *
 beste Teiler 123.0 (21.) 145.0 (30.) 197.2 (25.)
 Trefferlage 1.42 mm rechts, 0.13 mm tief
 Streuwert 2.01, horizontal: 2.57, vertikal: 1.20

Unterschrift des Schützen

Ergebnis: **302.0** (290)
 Serien: 101.2 98.4 102.4
 Zähler: 22 7 0 1 0 0 0 0 0 0
 Innenzehner: 16
 weiteste: 890 (15), 424 (7), 373 (13)
 beste Teiler 34.1 (24.) 49.4 (20.) 71.1 (21.)
 Trefferlage 0.56 mm links, 0.22 mm hoch
 Streuwert 1.90, horizontal: 2.19, vertikal: 1.57

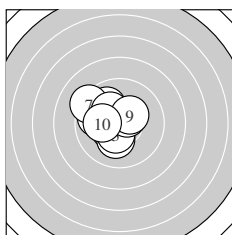
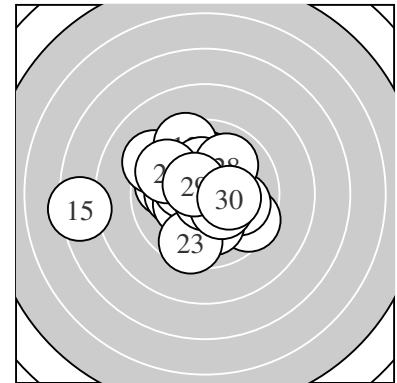

Serie 1:
 10.4 * 10.2 * 10.4 * 10.5 * 9.8 ↖
 10.0 ↘ 9.3 ↘ 10.2 * 10.3 * 10.1 ←
 beste Teiler 106.2 (4.) 134.7 (3.) 135.2 (1.)
 Trefferlage 1.09 mm links, 0.39 mm hoch
 Streuwert 1.43, horizontal: 1.49, vertikal: 1.38

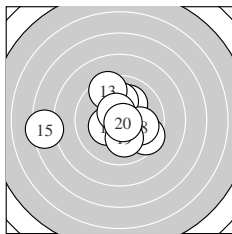

Serie 2:
 10.1 ↗ 10.1 ↑ 9.5 ↖ 10.3 * 7.4 ←
 10.6 * 9.5 ↘ 10.0 → 10.1 ↓ 10.8 *
 beste Teiler 49.4 (20.) 100.7 (16.) 159.6 (14.)
 Trefferlage 0.46 mm links, 0.18 mm hoch
 Streuwert 2.66, horizontal: 3.28, vertikal: 1.85

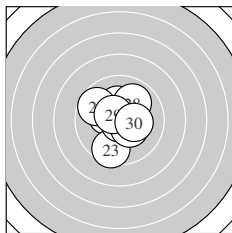

Serie 3:
 10.7 * 10.3 * 9.5 ↓ 10.8 * 10.2 *
 9.7 ↘ 10.4 * 9.9 ↗ 10.6 * 10.3 *
 beste Teiler 34.1 (24.) 71.1 (21.) 99.9 (29.)
 Trefferlage 0.14 mm links, 0.10 mm hoch
 Streuwert 1.50, horizontal: 1.39, vertikal: 1.60

Unterschrift des Schützen

Ergebnis: **303.1** (291)
 Serien: 100.8 104.0 98.3
 Zähler: 23 5 2 0 0 0 0 0 0 0
 Innenzehner: 19
 weiteste: 750 (21), 575 (7), 364 (4)
 beste Teiler 2.2 (16.) 27.3 (18.) 41.0 (1.)
 Trefferlage 0.07 mm links, 0.08 mm hoch
 Streuwert 1.88, horizontal: 2.47, vertikal: 0.99

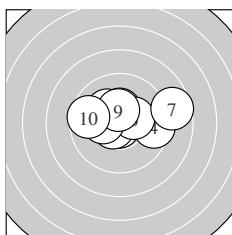
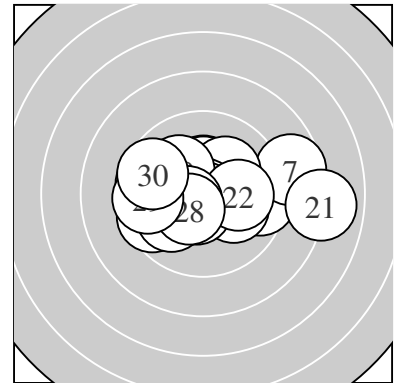

Serie 1:
 10.8 * 10.4 * 10.2 * 9.5 → 10.6 *
 10.3 * 8.7 → 10.3 * 10.4 * 9.6 ←
 beste Teiler 41.0 (1.) 83.4 (5.) 138.7 (9.)
 Trefferlage 0.33 mm rechts, 0.57 mm hoch
 Streuwert 1.93, horizontal: 2.60, vertikal: 0.83

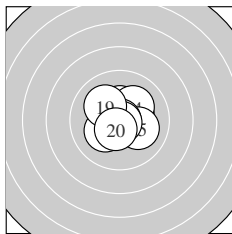

Serie 2:
 10.5 * 10.3 * 10.4 * 10.2 * 10.1 →
 10.9 * 10.2 * 10.8 * 10.1 ↖ 10.5 *
 beste Teiler 2.2 (16.) 27.3 (18.) 104.3 (20.)
 Trefferlage 0.08 mm rechts, 0.26 mm hoch
 Streuwert 1.12, horizontal: 1.19, vertikal: 1.03

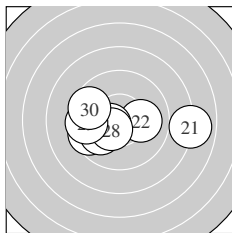

Serie 3:
 8.0 → 10.1 → 10.3 * 10.4 * 9.5 ←
 10.0 ↙ 10.5 * 10.4 * 9.5 ← 9.6 ↖
 beste Teiler 112.7 (27.) 130.2 (28.) 135.3 (24.)
 Trefferlage 0.65 mm links, 0.58 mm tief
 Streuwert 2.40, horizontal: 3.30, vertikal: 0.79

Unterschrift des Schützen

Ergebnis: **282.5** (270)
 Serien: 94.0 96.1 92.4
 Zähler: 4 22 4 0 0 0 0 0 0 0
 Innenzehner: 3
 weiteste: 722 (1), 680 (22), 634 (11)
 beste Teiler 59.4 (12.) 173.0 (5.) 191.5 (2.)
 Trefferlage 0.24 mm rechts, 1.89 mm tief
 Streuwert 2.60, horizontal: 2.97, vertikal: 2.17

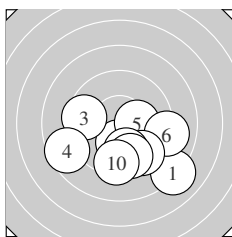
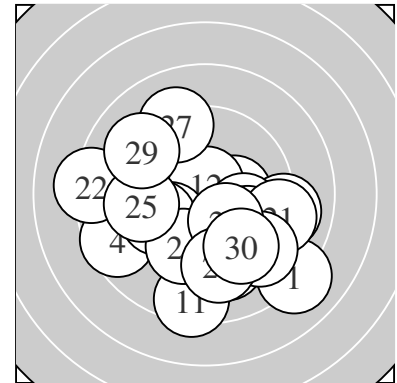

Serie 1:
 8.1 ↘ 10.2 * 9.5 ← 8.6 ↙ 10.3 *
 9.0 → 9.5 ↘ 9.8 ↓ 9.6 ↓ 9.4 ↓
 beste Teiler 173.0 (5.) 191.5 (2.) 279.4 (8.)
 Trefferlage 0.64 mm rechts, 2.28 mm tief
 Streuwert 2.60, horizontal: 3.26, vertikal: 1.72

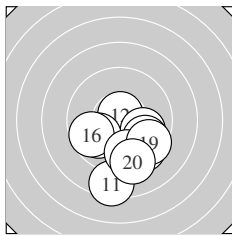

Serie 2:
 8.4 ↓ 10.7 * 9.9 ↘ 9.9 ↙ 9.7 ↘
 9.7 ↙ 9.5 ↘ 9.6 ↓ 9.5 ↘ 9.2 ↓
 beste Teiler 59.4 (12.) 252.1 (13.) 259.6 (14.)
 Trefferlage 0.64 mm rechts, 2.38 mm tief
 Streuwert 1.95, horizontal: 2.01, vertikal: 1.89

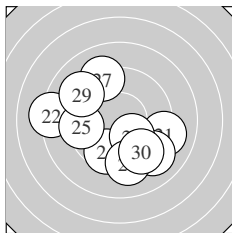

Serie 3:
 9.1 → 8.2 ← 9.1 ↘ 9.6 ↓ 9.4 ←
 10.1 ↘ 9.2 ↖ 9.2 ↓ 9.1 ↖ 9.4 ↘
 beste Teiler 201.8 (26.) 338.9 (24.) 378.9 (30.)
 Trefferlage 0.55 mm links, 1.01 mm tief
 Streuwert 3.17, horizontal: 3.55, vertikal: 2.72

Unterschrift des Schützen

Ergebnis: **301.0** (288)
 Serien: 99.0 101.7 100.3
 Zähler: 19 10 1 0 0 0 0 0 0 0
 Innenzehner: 12
 weiteste: 659 (5), 478 (10), 423 (21)
 beste Teiler 36.2 (7.) 41.4 (18.) 45.2 (29.)
 Trefferlage 0.07 mm links, 0.63 mm hoch
 Streuwert 1.88, horizontal: 1.89, vertikal: 1.87

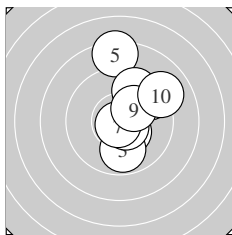
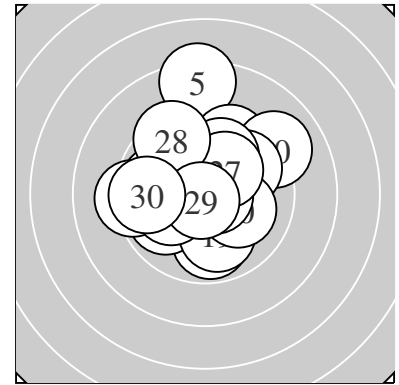

Serie 1:
 10.7 * 10.4 * 9.9 ↓ 10.6 * 8.3 ↑
 9.5 ↗ 10.8 * 9.6 ↗ 10.2 * 9.0 ↗
 beste Teiler 36.2 (7.) 66.1 (1.) 83.4 (4.)
 Trefferlage 1.16 mm rechts, 1.08 mm hoch
 Streuwert 2.11, horizontal: 1.38, vertikal: 2.65

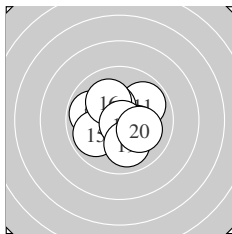

Serie 2:
 9.9 ↗ 9.9 ← 10.4 * 10.4 * 9.9 ↗
 10.1 ↘ 10.2 * 10.8 * 10.0 ↓ 10.1 ↘
 beste Teiler 41.4 (18.) 134.4 (14.) 142.2 (13.)
 Trefferlage 0.09 mm links, 0.03 mm hoch
 Streuwert 1.56, horizontal: 1.74, vertikal: 1.36

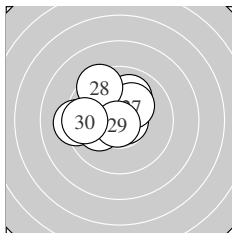

Serie 3:
 9.3 ← 10.1 ↘ 10.7 * 10.1 ← 10.0 ↘
 10.0 ↗ 10.2 * 9.5 ↘ 10.8 * 9.6 ←
 beste Teiler 45.2 (29.) 57.7 (23.) 181.8 (27.)
 Trefferlage 1.27 mm links, 0.78 mm hoch
 Streuwert 1.59, horizontal: 1.83, vertikal: 1.30

Unterschrift des Schützen

Ergebnis: **303.7** (289)
 Serien: 100.9 101.1 101.7
 Zähler: 19 11 0 0 0 0 0 0 0 0
 Innenzehner: 13
 weiteste: 324 (27), 307 (2), 301 (6)
 beste Teiler 63.5 (28.) 68.5 (1.) 86.0 (11.)
 Trefferlage 0.14 mm links, 0.19 mm tief
 Streuwert 1.57, horizontal: 1.45, vertikal: 1.68

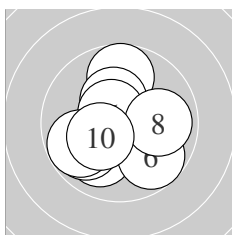
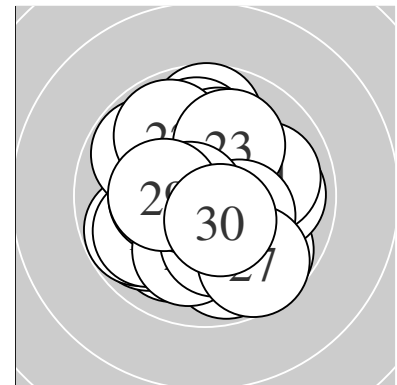

Serie 1:
 10.7 * 9.7 ↑ 10.3 * 10.0 ↙ 10.6 *
 9.7 ↘ 9.9 ↖ 9.9 → 9.8 ↗ 10.3 *
 beste Teiler 68.5 (1.) 86.6 (5.) 154.5 (3.)
 Trefferlage 0.31 mm links, 0.21 mm tief
 Streuwert 1.69, horizontal: 1.70, vertikal: 1.69

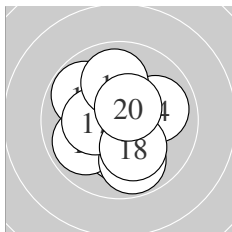

Serie 2:
 10.6 * 9.8 ↘ 10.2 * 10.0 → 9.9 ↖ 10.5 *
 9.8 ↓ 10.3 * 10.1 ↓ 9.9 ↑ 10.5 *
 beste Teiler 86.0 (11.) 102.3 (20.) 162.1 (17.)
 Trefferlage 0.26 mm links, 0.16 mm tief
 Streuwert 1.61, horizontal: 1.51, vertikal: 1.70

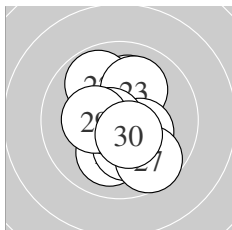

Serie 3:
 10.1 ↑ 9.8 ↘ 10.1 ↗ 10.0 ↙ 10.3 *
 10.2 * 9.7 ↘ 10.7 * 10.3 * 10.5 *
 beste Teiler 63.5 (28.) 114.5 (30.) 158.1 (25.)
 Trefferlage 0.14 mm rechts, 0.18 mm tief
 Streuwert 1.54, horizontal: 1.19, vertikal: 1.83

Unterschrift des Schützen

Ergebnis: **306.2** (293)
 Serien: 103.6 101.3 101.3
 Zähler: 23 7 0 0 0 0 0 0 0 0
 Innenzehner: 18
 weiteste: 414 (20), 411 (24), 305 (21)
 beste Teiler 24.1 (29.) 35.9 (27.) 43.8 (8.)
 Trefferlage 0.44 mm rechts, 0.19 mm tief
 Streuwert 1.48, horizontal: 1.53, vertikal: 1.43

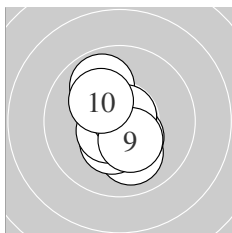
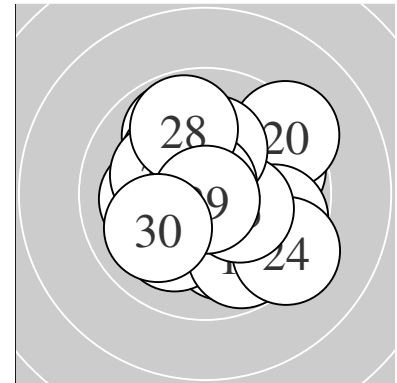

Serie 1:
 10.0 ↘ 10.3 * 9.9 ↗ 10.4 * 10.4 *
 10.7 * 10.5 * 10.8 * 10.4 * 10.2 *
 beste Teiler 43.8 (8.) 73.8 (6.) 101.4 (7.)
 Trefferlage 0.02 mm links, 0.43 mm tief
 Streuwert 1.16, horizontal: 0.85, vertikal: 1.41

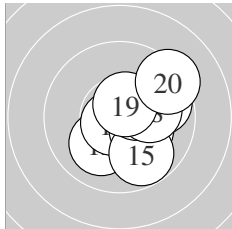

Serie 2:
 10.2 * 10.1 ↙ 10.7 * 10.3 * 9.8 ↘
 10.4 * 9.8 → 10.1 → 10.6 * 9.3 ↗
 beste Teiler 61.6 (13.) 97.1 (19.) 133.3 (16.)
 Trefferlage 1.24 mm rechts, 0.12 mm tief
 Streuwert 1.45, horizontal: 1.40, vertikal: 1.49

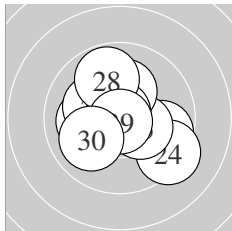

Serie 3:
 9.7 ↘ 10.1 ← 10.2 * 9.3 ↘ 10.3 *
 10.2 * 10.8 * 9.8 ↗ 10.9 * 10.0 ↙
 beste Teiler 24.1 (29.) 35.9 (27.) 157.3 (25.)
 Trefferlage 0.12 mm rechts, 0.01 mm tief
 Streuwert 1.74, horizontal: 1.94, vertikal: 1.51

Unterschrift des Schützen

Ergebnis: **298.0** (286)
 Serien: 97.9 99.7 100.4
 Zähler: 16 14 0 0 0 0 0 0 0 0
 Innenzehner: 10
 weiteste: 493 (7), 474 (10), 414 (1)
 beste Teiler 90.8 (9.) 104.0 (19.) 134.8 (27.)
 Trefferlage 0.43 mm rechts, 0.35 mm tief
 Streuwert 1.94, horizontal: 1.99, vertikal: 1.88

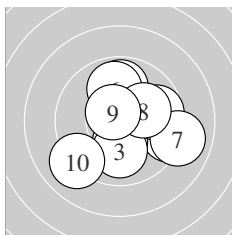
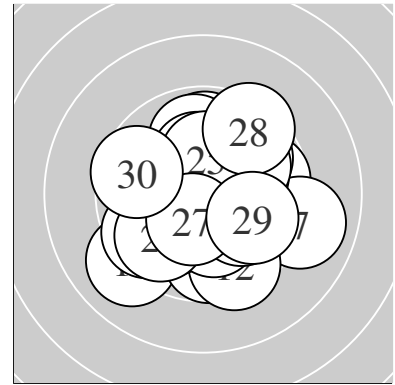

Serie 1:
 9.3 → 10.3 * 10.0 ↓ 9.7 → 9.9 ↑
 9.9 ↑ 9.0 → 10.1 ↗ 10.6 * 9.1 ↙
 beste Teiler 90.8 (9.) 171.0 (2.) 213.0 (8.)
 Trefferlage 0.93 mm rechts, 0.21 mm tief
 Streuwert 2.27, horizontal: 2.47, vertikal: 2.05

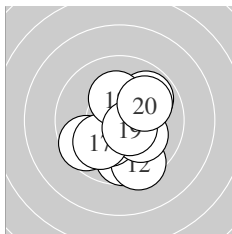

Serie 2:
 9.7 ↓ 9.5 ↘ 9.6 ↙ 10.3 * 9.8 ↗
 10.1 ↘ 10.0 ↙ 10.2 * 10.5 * 10.0 ↗
 beste Teiler 104.0 (19.) 173.1 (14.) 178.3 (18.)
 Trefferlage 0.31 mm rechts, 0.86 mm tief
 Streuwert 1.78, horizontal: 1.65, vertikal: 1.90

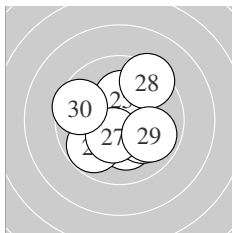

Serie 3:
 10.4 * 10.4 * 10.2 * 10.1 ↘ 10.2 *
 9.8 ↙ 10.4 * 9.4 ↗ 9.9 → 9.6 ←
 beste Teiler 134.8 (27.) 138.8 (22.) 145.9 (21.)
 Trefferlage 0.06 mm rechts, 0.02 mm hoch
 Streuwert 1.83, horizontal: 1.88, vertikal: 1.77

Unterschrift des Schützen

Ergebnis: **309.7** (296)
 Serien: 102.6 104.2 102.9
 Zähler: 26 4 0 0 0 0 0 0 0 0
 Innenzehner: 21
 weiteste: 354 (21), 338 (2), 289 (5)
 beste Teiler 28.8 (27.) 53.7 (7.) 72.3 (9.)
 Trefferlage 0.54 mm rechts, 0.12 mm tief
 Streuwert 1.20, horizontal: 1.46, vertikal: 0.87

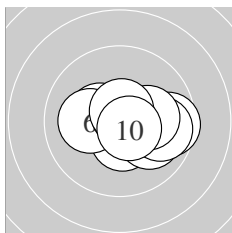
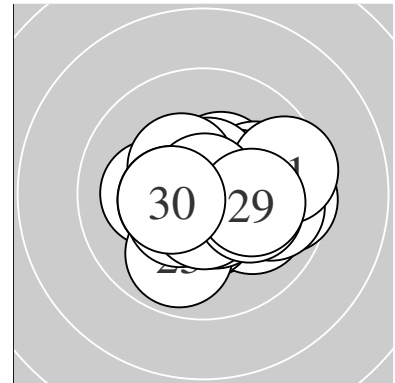

Serie 1:
 10.4 * 9.6 → 10.5 * 10.0 ↘ 9.8 →
 10.1 ← 10.7 * 10.2 * 10.7 * 10.6 *
 beste Teiler 53.7 (7.) 72.3 (9.) 83.6 (10.)
 Trefferlage 0.80 mm rechts, 0.17 mm tief
 Streuwert 1.33, horizontal: 1.75, vertikal: 0.66

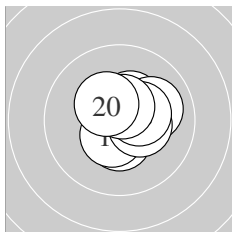

Serie 2:
 10.4 * 10.6 * 10.5 * 10.4 * 10.0 →
 10.5 * 10.4 * 10.4 * 10.6 * 10.4 *
 beste Teiler 77.8 (12.) 96.1 (19.) 115.3 (16.)
 Trefferlage 0.48 mm rechts, 0.32 mm hoch
 Streuwert 0.94, horizontal: 0.99, vertikal: 0.89

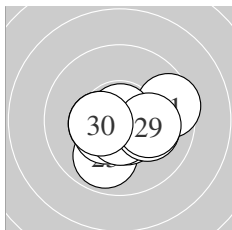

Serie 3:
 9.5 → 10.4 * 9.9 ↓ 10.6 * 10.5 *
 10.6 * 10.8 * 10.1 → 10.1 → 10.4 *
 beste Teiler 28.8 (27.) 90.1 (26.) 100.8 (24.)
 Trefferlage 0.33 mm rechts, 0.52 mm tief
 Streuwert 1.32, horizontal: 1.63, vertikal: 0.90

Unterschrift des Schützen

Ergebnis: **306.9** (294)
 Serien: 102.5 101.6 102.8
 Zähler: 24 6 0 0 0 0 0 0 0 0
 Innenzehner: 19
 weiteste: 373 (15), 366 (20), 315 (8)
 beste Teiler 58.4 (5.) 74.2 (22.) 74.3 (16.)
 Trefferlage 0.62 mm links, 0.00 mm
 Streuwert 1.36, horizontal: 1.34, vertikal: 1.37

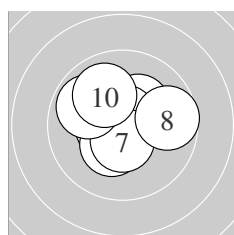
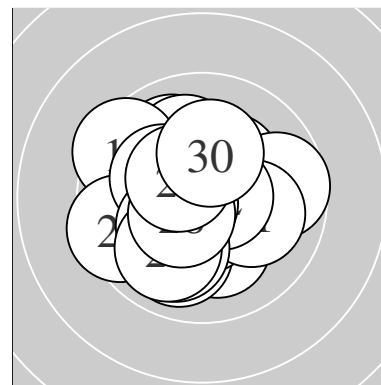

Serie 1:
 10.4 * 10.2 * 10.3 * 10.5 * 10.7 *
 10.3 * 10.5 * 9.7 → 9.9 ↖ 10.0 ↖
 beste Teiler 58.4 (5.) 104.0 (7.) 105.9 (4.)
 Trefferlage 0.30 mm links, 0.58 mm hoch
 Streuwert 1.34, horizontal: 1.53, vertikal: 1.13

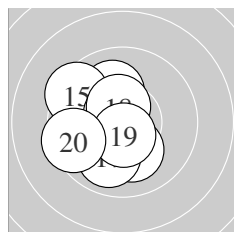

Serie 2:
 10.5 * 10.1 ↗ 10.2 * 10.1 ↘ 9.5 ↖
 10.7 * 9.9 ↙ 10.5 * 10.6 * 9.5 ←
 beste Teiler 74.3 (16.) 91.2 (19.) 112.0 (11.)
 Trefferlage 1.06 mm links, 0.23 mm tief
 Streuwert 1.46, horizontal: 1.31, vertikal: 1.60

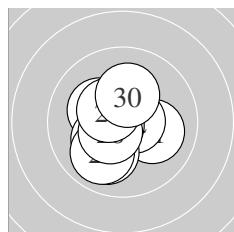

Serie 3:
 10.1 → 10.7 * 10.0 ↙ 10.2 * 10.2 *
 9.9 ↙ 10.6 * 10.5 * 10.4 * 10.2 *
 beste Teiler 74.2 (22.) 77.2 (27.) 109.0 (28.)
 Trefferlage 0.49 mm links, 0.33 mm tief
 Streuwert 1.24, horizontal: 1.18, vertikal: 1.29

Unterschrift des Schützen

Ergebnis: **301.5** (286)
 Serien: 100.6 101.0 99.9
 Zähler: 17 12 1 0 0 0 0 0 0 0
 Innenzehner: 14
 weiteste: 508 (29), 387 (16), 386 (24)
 beste Teiler 7.2 (19.) 44.5 (6.) 54.7 (22.)
 Trefferlage 0.04 mm rechts, 0.38 mm tief
 Streuwert 1.76, horizontal: 1.73, vertikal: 1.79

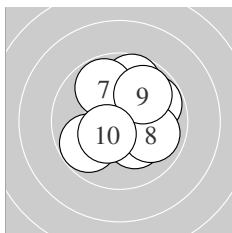
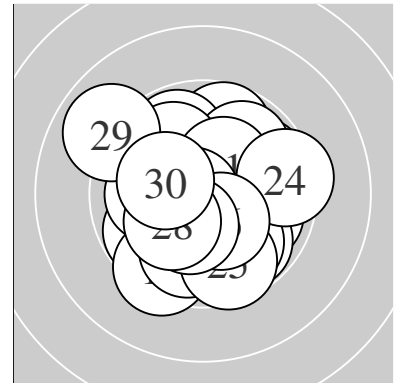

Serie 1:
 9.8 ↙ 9.7 ↑ 9.8 ↘ 10.2 * 10.3 *
 10.8 * 9.8 ↘ 9.9 → 9.9 ↗ 10.4 *
 beste Teiler 44.5 (6.) 137.8 (10.) 164.6 (5.)
 Trefferlage 0.57 mm rechts, 0.50 mm hoch
 Streuwert 1.67, horizontal: 1.62, vertikal: 1.72

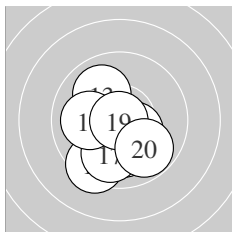

Serie 2:
 10.2 * 10.3 * 10.0 ↘ 10.4 * 10.1 ↓
 9.4 ↙ 9.9 ↓ 10.0 ← 10.9 * 9.8 ↘
 beste Teiler 7.2 (19.) 139.2 (14.) 173.4 (12.)
 Trefferlage 0.41 mm links, 1.26 mm tief
 Streuwert 1.44, horizontal: 1.30, vertikal: 1.56

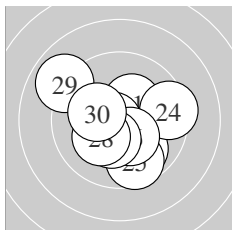

Serie 3:
 10.3 * 10.7 * 9.9 ↘ 9.4 → 9.6 ↓
 10.4 * 10.3 * 10.2 * 8.9 ↖ 10.2 *
 beste Teiler 54.7 (22.) 150.3 (26.) 157.8 (27.)
 Trefferlage 0.03 mm links, 0.38 mm tief
 Streuwert 2.00, horizontal: 2.19, vertikal: 1.79

Unterschrift des Schützen

Ergebnis: **297.4** (282)
 Serien: 102.7 101.2 93.5
 Zähler: 19 10 0 0 0 0 0 0 1 0
 Innenzehner: 14
 weiteste: 2146 (30), 393 (25), 347 (16)
 beste Teiler 50.1 (18.) 61.5 (28.) 84.0 (4.)
 Trefferlage 1.15 mm rechts, 0.14 mm hoch
 Streuwert 3.10, horizontal: 3.79, vertikal: 2.20

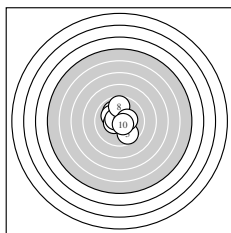
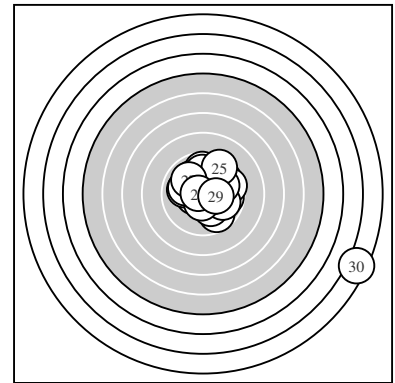

Serie 1:
 10.6 * 10.0 ↘ 10.1 ↘ 10.6 * 9.7 ↘
 10.5 * 10.6 * 9.7 ↑ 10.3 * 10.6 *
 beste Teiler 84.0 (4.) 90.0 (1.) 93.5 (10.)
 Trefferlage 0.04 mm rechts, 0.37 mm hoch
 Streuwert 1.39, horizontal: 1.24, vertikal: 1.53

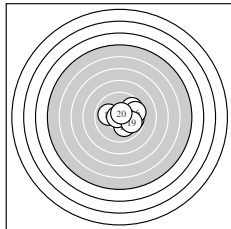

Serie 2:
 9.8 → 10.3 * 10.4 * 10.0 ← 9.7 ↗
 9.6 → 10.1 ↘ 10.8 * 9.9 → 10.6 *
 beste Teiler 50.1 (18.) 88.6 (20.) 132.3 (13.)
 Trefferlage 1.25 mm rechts, 0.17 mm hoch
 Streuwert 1.44, horizontal: 1.74, vertikal: 1.07

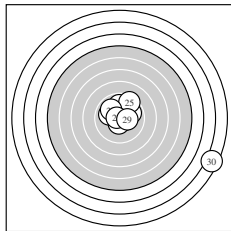

Serie 3:
 9.9 ↑ 10.5 * 9.9 ↗ 10.5 * 9.4 ↗
 10.0 ↖ 9.9 ↘ 10.7 * 10.3 * 2.4 ↘
 beste Teiler 61.5 (28.) 114.4 (24.) 115.4 (22.)
 Trefferlage 2.17 mm rechts, 0.10 mm tief
 Streuwert 5.06, horizontal: 6.26, vertikal: 3.46

Unterschrift des Schützen

Ergebnis: **288.5** (277)
 Serien: 98.1 96.1 94.3
 Zähler: 18 6 3 2 0 1 0 0 0 0
 Innenzehner: 11
 weiteste: 1388 (18), 910 (22), 827 (29)
 beste Teiler 27.2 (8.) 56.7 (21.) 105.8 (14.)
 Trefferlage 0.75 mm links, 0.04 mm hoch
 Streuwert 3.10, horizontal: 4.08, vertikal: 1.63

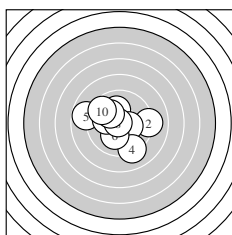
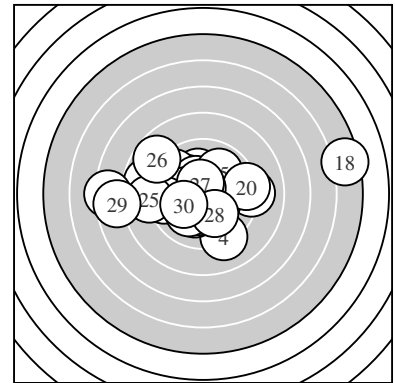

Serie 1:
 10.1 ↑ 9.1 → 10.3 * 9.1 ↓ 8.8 ←
 10.1 ↓ 10.1 ← 10.8 * 10.1 ↖ 9.6 ↗
 beste Teiler 27.2 (8.) 154.1 (3.) 205.9 (6.)
 Trefferlage 0.51 mm links, 0.10 mm hoch
 Streuwert 2.37, horizontal: 2.75, vertikal: 1.90

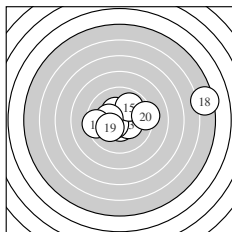

Serie 2:
 10.3 * 10.5 * 10.3 * 10.5 * 9.9 ↗
 10.3 * 9.4 ← 5.4 → 10.2 * 9.3 →
 beste Teiler 105.8 (14.) 111.3 (12.) 153.4 (11.)
 Trefferlage 1.22 mm rechts, 0.33 mm hoch
 Streuwert 3.57, horizontal: 4.83, vertikal: 1.45

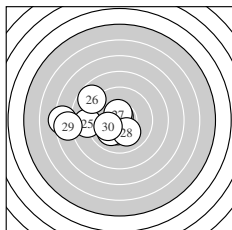

Serie 3:
 10.7 * 7.3 ← 10.3 * 10.1 ↓ 8.9 ←
 8.7 ↖ 10.5 * 10.1 ↓ 7.6 ← 10.1 ←
 beste Teiler 56.7 (21.) 106.2 (27.) 172.3 (23.)
 Trefferlage 2.96 mm links, 0.28 mm tief
 Streuwert 2.77, horizontal: 3.57, vertikal: 1.61

Unterschrift des Schützen

Ergebnis: **297.6** (281)
 Serien: 100.7 98.6 98.3
 Zähler: 12 17 1 0 0 0 0 0 0 0
 Innenzehner: 8
 weiteste: 548 (17), 379 (25), 374 (30)
 beste Teiler 58.7 (13.) 71.0 (5.) 103.7 (1.)
 Trefferlage 0.10 mm links, 0.68 mm tief
 Streuwert 1.93, horizontal: 2.17, vertikal: 1.64

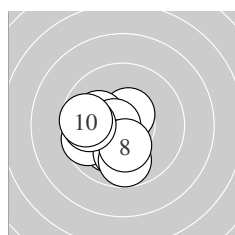
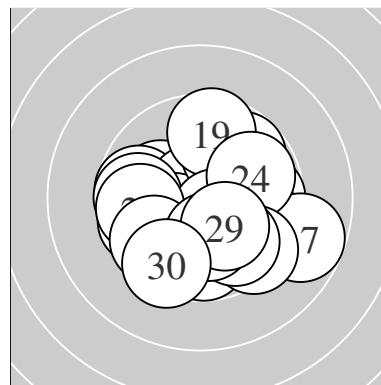

Serie 1:
 10.5 * 10.1 ↙ 9.7 ← 10.1 ↖ 10.7 *
 10.0 ↓ 9.8 ↓ 10.3 * 9.8 ← 9.7 ←
 beste Teiler 71.0 (5.) 103.7 (1.) 172.2 (8.)
 Trefferlage 1.20 mm links, 0.78 mm tief
 Streuwert 1.39, horizontal: 1.41, vertikal: 1.36

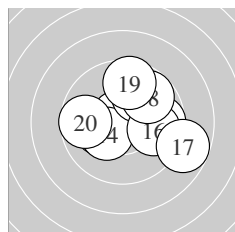

Serie 2:
 9.7 → 10.2 * 10.7 * 10.3 * 9.9 ↗
 9.9 → 8.8 ↘ 9.8 ↗ 9.6 ↑ 9.7 ←
 beste Teiler 58.7 (13.) 165.2 (14.) 192.9 (12.)
 Trefferlage 0.81 mm rechts, 0.39 mm hoch
 Streuwert 2.14, horizontal: 2.53, vertikal: 1.66

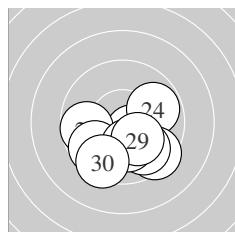

Serie 3:
 10.5 * 9.7 ← 9.6 ↙ 9.8 → 9.4 ↘
 9.7 ↗ 9.8 ↘ 10.1 ↓ 10.2 * 9.5 ↙
 beste Teiler 112.4 (21.) 191.3 (29.) 201.6 (28.)
 Trefferlage 0.07 mm rechts, 1.66 mm tief
 Streuwert 1.76, horizontal: 2.12, vertikal: 1.30

Unterschrift des Schützen

Meyton Elektronik

Ergebnis: **311.5** (296)
 Serien: 103.0 105.1 103.4
 Zähler: 26 4 0 0 0 0 0 0 0 0
 Innenzehner: 23
 weiteste: 380 (6), 297 (7), 276 (24)
 beste Teiler 19.8 (27.) 35.5 (16.) 60.9 (10.)
 Trefferlage 0.04 mm rechts, 0.27 mm tief
 Streuwert 1.16, horizontal: 1.37, vertikal: 0.89

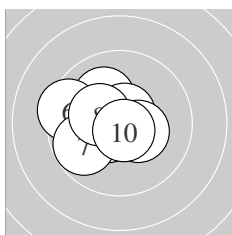
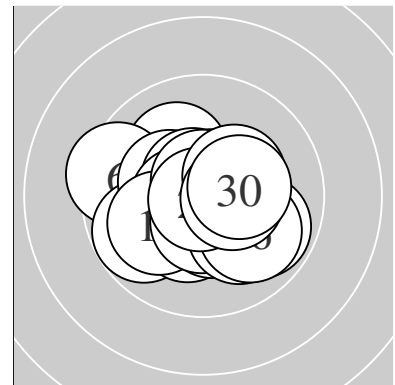

Serie 1:
 10.5 * 10.6 * 10.1 ↗ 10.7 * 10.5 *
 9.4 ← 9.8 ↙ 10.3 * 10.4 * 10.7 *
 beste Teiler 60.9 (10.) 72.9 (4.) 82.0 (2.)
 Trefferlage 0.93 mm links, 0.01 mm hoch
 Streuwert 1.23, horizontal: 1.45, vertikal: 0.97

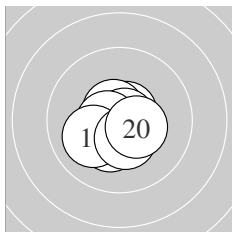

Serie 2:
 10.7 * 10.7 * 10.3 * 10.6 * 10.5 *
 10.8 * 10.6 * 10.1 ↙ 10.4 * 10.4 *
 beste Teiler 35.5 (16.) 65.3 (11.) 71.0 (12.)
 Trefferlage 0.05 mm links, 0.43 mm tief
 Streuwert 0.86, horizontal: 0.91, vertikal: 0.80

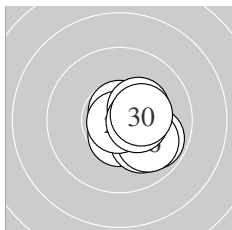

Serie 3:
 10.5 * 10.7 * 10.5 * 9.8 ↘ 10.1 ↘
 9.9 ↘ 10.9 * 10.3 * 10.4 * 10.3 *
 beste Teiler 19.8 (27.) 62.0 (22.) 110.0 (21.)
 Trefferlage 1.11 mm rechts, 0.39 mm tief
 Streuwert 0.90, horizontal: 0.90, vertikal: 0.90

Unterschrift des Schützen

Ergebnis: **313.5** (298)
 Serien: 105.2 104.2 104.1
 Zähler: 28 2 0 0 0 0 0 0 0 0
 Innenzehner: 27
 weiteste: 357 (27), 257 (14), 222 (18)
 beste Teiler 26.4 (22.) 37.5 (23.) 47.2 (16.)
 Trefferlage 0.21 mm rechts, 0.07 mm tief
 Streuwert 1.00, horizontal: 1.14, vertikal: 0.84

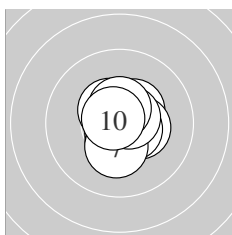
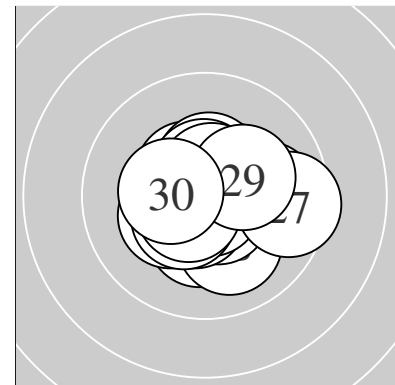

Serie 1:
 10.5 * 10.4 * 10.4 * 10.5 * 10.6 *
 10.7 * 10.3 * 10.6 * 10.5 * 10.7 *
 beste Teiler 57.2 (6.) 57.2 (10.) 77.6 (8.)
 Trefferlage 0.19 mm rechts, 0.04 mm tief
 Streuwert 0.82, horizontal: 0.70, vertikal: 0.92

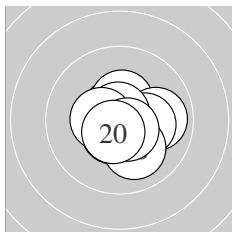

Serie 2:
 10.6 * 10.6 * 10.4 * 9.9 → 10.2 *
 10.8 * 10.4 * 10.1 ↘ 10.6 * 10.6 *
 beste Teiler 47.2 (16.) 78.0 (11.) 86.6 (19.)
 Trefferlage 0.33 mm rechts, 0.20 mm tief
 Streuwert 1.06, horizontal: 1.16, vertikal: 0.93

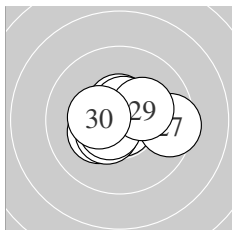

Serie 3:
 10.5 * 10.8 * 10.8 * 10.3 * 10.6 *
 10.4 * 9.5 → 10.6 * 10.2 * 10.4 *
 beste Teiler 26.4 (22.) 37.5 (23.) 90.2 (28.)
 Trefferlage 0.09 mm rechts, 0.01 mm hoch
 Streuwert 1.19, horizontal: 1.52, vertikal: 0.71

Unterschrift des Schützen

Ergebnis: **313.9** (300)
 Serien: 103.3 105.1 105.5
 Zähler: 30 0 0 0 0 0 0 0 0 0
 Innenzehner: 26
 weiteste: 244 (4), 235 (6), 227 (9)
 beste Teiler 11.1 (15.) 48.3 (28.) 48.4 (23.)
 Trefferlage 0.11 mm rechts, 0.25 mm tief
 Streuwert 0.96, horizontal: 1.01, vertikal: 0.91

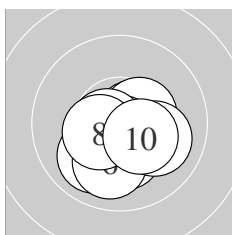
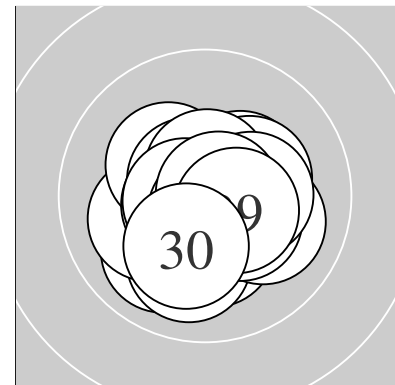

Serie 1:
 10.2 * 10.6 * 10.4 * 10.0 ↙ 10.7 *
 10.0 ↓ 10.6 * 10.4 * 10.0 → 10.4 *
 beste Teiler 61.3 (5.) 76.4 (7.) 83.9 (2.)
 Trefferlage 0.17 mm rechts, 0.82 mm tief
 Streuwert 1.05, horizontal: 1.16, vertikal: 0.93

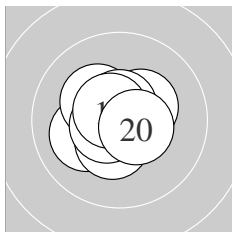

Serie 2:
 10.1 ↙ 10.4 * 10.4 * 10.7 * 10.9 *
 10.3 * 10.6 * 10.6 * 10.6 * 10.5 *
 beste Teiler 11.1 (15.) 61.5 (14.) 77.0 (17.)
 Trefferlage 0.29 mm links, 0.10 mm hoch
 Streuwert 0.88, horizontal: 0.96, vertikal: 0.79

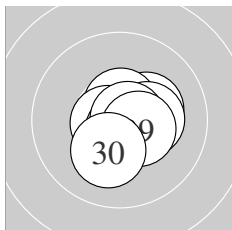

Serie 3:
 10.6 * 10.3 * 10.8 * 10.6 * 10.7 *
 10.7 * 10.3 * 10.8 * 10.5 * 10.2 *
 beste Teiler 48.3 (28.) 48.4 (23.) 64.8 (26.)
 Trefferlage 0.46 mm rechts, 0.05 mm tief
 Streuwert 0.81, horizontal: 0.83, vertikal: 0.79

Unterschrift des Schützen

Ergebnis: **303.2** (289)
 Serien: 100.1 102.7 100.4
 Zähler: 19 11 0 0 0 0 0 0 0 0
 Innenzehner: 11
 weiteste: 357 (11), 351 (22), 351 (23)
 beste Teiler 14.2 (19.) 24.7 (30.) 74.6 (20.)
 Trefferlage 0.37 mm rechts, 0.52 mm hoch
 Streuwert 1.58, horizontal: 1.75, vertikal: 1.40

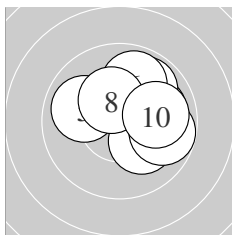
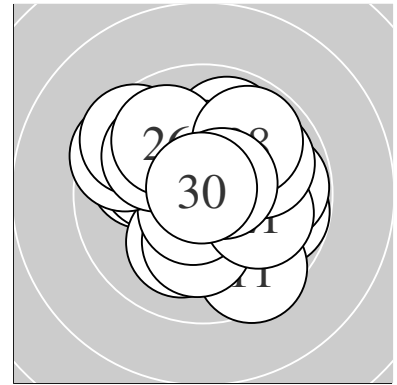

Serie 1:
 10.0 → 10.0 → 10.1 ↗ 9.9 ↗ 9.9 ↖
 9.9 ↗ 10.2 * 10.3 * 9.8 → 10.0 →
 beste Teiler 152.2 (8.) 199.7 (7.) 208.4 (3.)
 Trefferlage 1.20 mm rechts, 0.70 mm hoch
 Streuwert 1.47, horizontal: 1.61, vertikal: 1.32

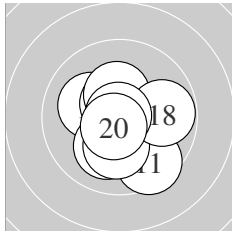

Serie 2:
 9.5 ↘ 10.1 ↖ 10.1 ↙ 10.6 * 10.5 *
 10.3 * 10.2 * 9.8 → 10.9 * 10.7 *
 beste Teiler 14.2 (19.) 74.6 (20.) 83.7 (14.)
 Trefferlage 0.14 mm rechts, 0.35 mm tief
 Streuwert 1.43, horizontal: 1.39, vertikal: 1.47

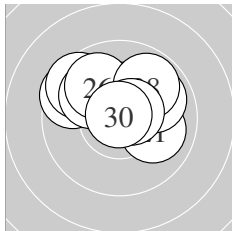

Serie 3:
 10.0 → 9.5 ↖ 9.5 ↖ 10.3 * 10.0 ↖
 9.9 ↖ 9.9 → 9.8 ↗ 10.6 * 10.9 *
 beste Teiler 24.7 (30.) 87.7 (29.) 153.0 (24.)
 Trefferlage 0.21 mm links, 1.22 mm hoch
 Streuwert 1.59, horizontal: 2.02, vertikal: 0.97

Unterschrift des Schützen

Ergebnis: **307.2** (294)
 Serien: 101.9 102.6 102.7
 Zähler: 24 6 0 0 0 0 0 0 0 0
 Innenzehner: 20
 weiteste: 413 (1), 398 (9), 396 (25)
 beste Teiler 27.2 (30.) 34.4 (26.) 44.2 (22.)
 Trefferlage 0.18 mm rechts, 0.31 mm hoch
 Streuwert 1.47, horizontal: 1.70, vertikal: 1.20

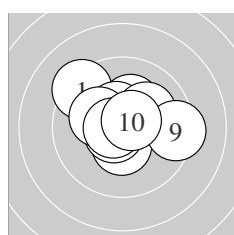
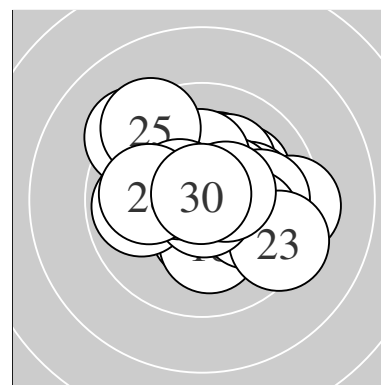

Serie 1:
 9.3 ↘ 10.2 * 10.4 * 10.4 * 10.6 *
 10.1 ↗ 10.2 * 10.7 * 9.4 → 10.6 *
 beste Teiler 70.2 (8.) 77.3 (5.) 82.0 (10.)
 Trefferlage 0.03 mm rechts, 0.59 mm hoch
 Streuwert 1.60, horizontal: 1.92, vertikal: 1.19

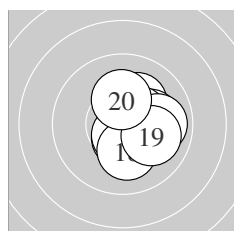

Serie 2:
 10.2 * 10.1 → 10.5 * 10.4 * 9.9 →
 10.5 * 10.6 * 10.2 * 10.0 → 10.2 *
 beste Teiler 81.3 (17.) 104.3 (16.) 108.7 (13.)
 Trefferlage 0.94 mm rechts, 0.08 mm hoch
 Streuwert 1.13, horizontal: 1.02, vertikal: 1.23

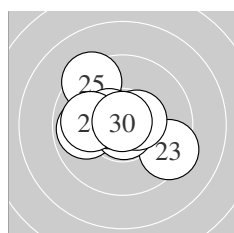

Serie 3:
 9.9 ← 10.8 * 9.4 ↘ 10.6 * 9.4 ↖
 10.8 * 10.5 * 10.0 ← 10.5 * 10.8 *
 beste Teiler 27.2 (30.) 34.4 (26.) 44.2 (22.)
 Trefferlage 0.43 mm links, 0.28 mm hoch
 Streuwert 1.59, horizontal: 1.87, vertikal: 1.24

Unterschrift des Schützen

Meyton Elektronik

Ergebnis: **300.7** (289)
 Serien: 101.0 99.2 100.5
 Zähler: 19 11 0 0 0 0 0 0 0 0
 Innenzehner: 11
 weiteste: 454 (18), 452 (6), 357 (21)
 beste Teiler 37.4 (10.) 69.9 (4.) 81.0 (27.)
 Trefferlage 0.01 mm rechts, 0.13 mm hoch
 Streuwert 1.82, horizontal: 2.16, vertikal: 1.40

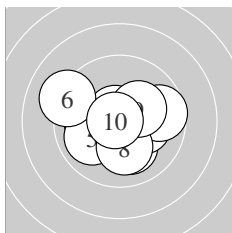
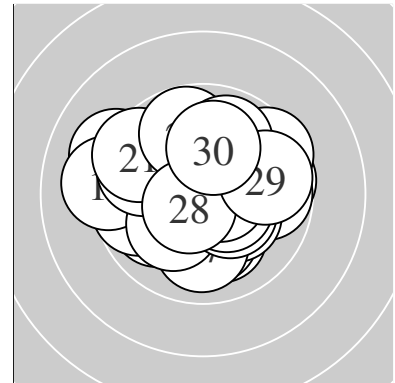

Serie 1:
 10.1 ↘ 10.2 * 10.1 ← 10.7 * 10.0 ↙
 9.1 ↖ 9.7 → 10.1 ↓ 10.2 * 10.8 *
 beste Teiler 37.4 (10.) 69.9 (4.) 177.7 (9.)
 Trefferlage 0.15 mm links, 0.16 mm tief
 Streuwert 1.79, horizontal: 2.19, vertikal: 1.27

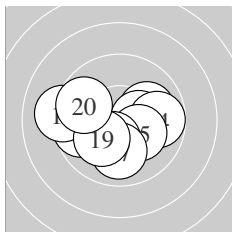

Serie 2:
 10.0 → 10.3 * 9.7 ← 9.8 → 10.2 *
 10.3 * 10.0 ↓ 9.1 ← 10.1 ↙ 9.7 ↖
 beste Teiler 152.3 (12.) 165.7 (16.) 181.6 (15.)
 Trefferlage 0.43 mm links, 0.44 mm tief
 Streuwert 1.95, horizontal: 2.50, vertikal: 1.17

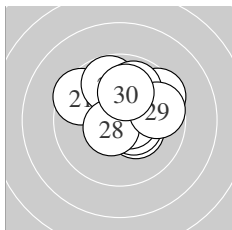

Serie 3:
 9.5 ↖ 9.5 ↗ 9.8 ↑ 9.9 ↗ 10.3 *
 10.5 * 10.6 * 10.6 * 9.7 → 10.1 ↑
 beste Teiler 81.0 (27.) 88.5 (28.) 124.8 (26.)
 Trefferlage 0.62 mm rechts, 1.00 mm hoch
 Streuwert 1.62, horizontal: 1.81, vertikal: 1.41

Unterschrift des Schützen

Ergebnis: **302.8** (291)
 Serien: 101.0 100.5 101.3
 Zähler: 21 9 0 0 0 0 0 0 0 0
 Innenzehner: 14
 weiteste: 450 (11), 349 (28), 346 (14)
 beste Teiler 10.7 (20.) 47.3 (1.) 103.0 (27.)
 Trefferlage 0.23 mm rechts, 1.27 mm hoch
 Streuwert 1.42, horizontal: 1.67, vertikal: 1.10

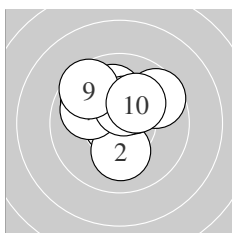
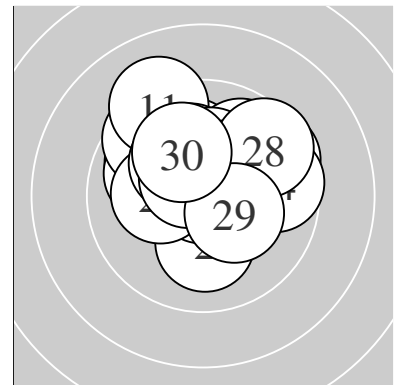

Serie 1:
 10.8 * 10.1 ↓ 9.6 ↗ 10.3 * 9.9 ↘
 10.1 ↑ 10.0 ↖ 10.4 * 9.6 ↖ 10.2 *
 beste Teiler 47.3 (1.) 132.6 (8.) 169.1 (4.)
 Trefferlage 0.24 mm links, 1.12 mm hoch
 Streuwert 1.51, horizontal: 1.67, vertikal: 1.33

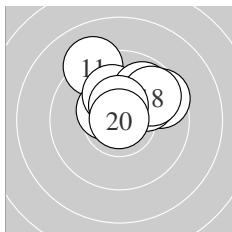

Serie 2:
 9.2 ↘ 10.4 * 10.1 ↗ 9.6 ↗ 10.1 ↑
 9.9 ↗ 10.0 ↗ 9.8 ↗ 10.5 * 10.9 *
 beste Teiler 10.7 (20.) 111.3 (19.) 126.6 (12.)
 Trefferlage 0.64 mm rechts, 1.67 mm hoch
 Streuwert 1.37, horizontal: 1.64, vertikal: 1.04

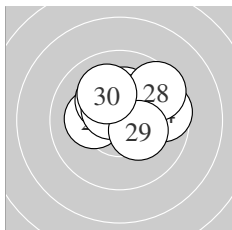

Serie 3:
 10.3 * 10.2 * 10.2 * 9.6 → 10.2 *
 10.3 * 10.5 * 9.6 ↗ 10.3 * 10.1 ↘
 beste Teiler 103.0 (27.) 159.1 (21.) 160.5 (26.)
 Trefferlage 0.30 mm rechts, 1.04 mm hoch
 Streuwert 1.40, horizontal: 1.76, vertikal: 0.90

Unterschrift des Schützen

Ergebnis: **300.0** (284)
 Serien: 99.5 99.3 101.2
 Zähler: 14 16 0 0 0 0 0 0 0 0
 Innenzehner: 10
 weiteste: 431 (23), 391 (5), 328 (7)
 beste Teiler 27.3 (21.) 61.2 (16.) 86.9 (2.)
 Trefferlage 0.28 mm rechts, 0.34 mm tief
 Streuwert 1.83, horizontal: 1.84, vertikal: 1.82

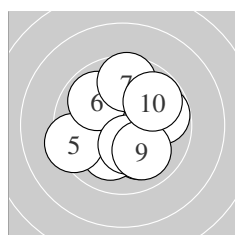
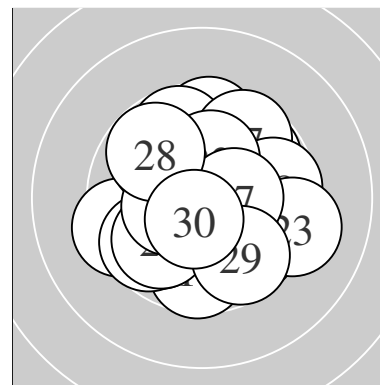

Serie 1:
 10.0 ↘ 10.6 * 9.8 → 10.1 ✓ 9.4 ←
 9.9 ↙ 9.6 ↑ 10.3 * 10.0 ↘ 9.8 ↗
 beste Teiler 86.9 (2.) 151.8 (8.) 214.2 (4.)
 Trefferlage 0.24 mm rechts, 0.01 mm tief
 Streuwert 1.95, horizontal: 1.97, vertikal: 1.92

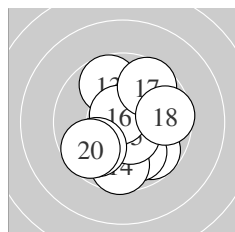

Serie 2:
 9.8 ↘ 10.0 ↘ 9.7 ↗ 9.7 ↓ 10.5 *
 10.7 * 9.7 ↗ 9.6 → 9.9 ✓ 9.7 ✓
 beste Teiler 61.2 (16.) 112.3 (15.) 250.8 (12.)
 Trefferlage 0.30 mm rechts, 0.58 mm tief
 Streuwert 1.99, horizontal: 1.83, vertikal: 2.13

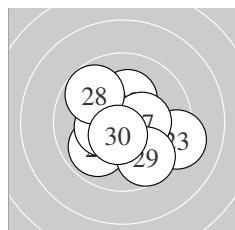

Serie 3:
 10.8 * 10.2 * 9.2 → 9.9 ✓ 10.3 *
 10.4 * 10.4 * 9.8 ↙ 9.7 ↘ 10.5 *
 beste Teiler 27.3 (21.) 103.4 (30.) 146.0 (27.)
 Trefferlage 0.30 mm rechts, 0.43 mm tief
 Streuwert 1.72, horizontal: 1.91, vertikal: 1.50

Unterschrift des Schützen

Meyton Elektronik

Ergebnis: **308.8** (296)
 Serien: 102.6 102.5 103.7
 Zähler: 26 4 0 0 0 0 0 0 0 0
 Innenzehner: 20
 weiteste: 378 (11), 278 (3), 260 (5)
 beste Teiler 32.3 (10.) 75.0 (24.) 80.2 (28.)
 Trefferlage 0.47 mm rechts, 0.14 mm hoch
 Streuwert 1.23, horizontal: 1.24, vertikal: 1.22

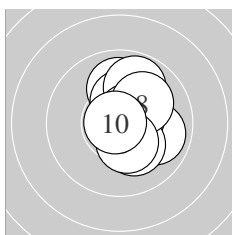
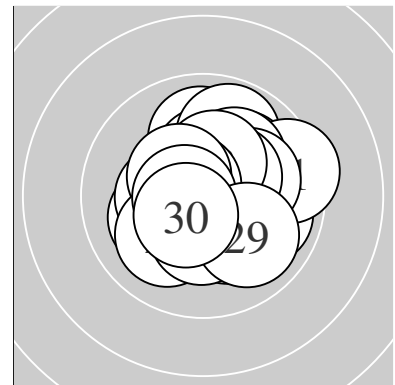

Serie 1:
 10.0 ↑ 10.3 * 9.8 ↗ 10.6 * 9.9 →
 10.5 * 10.2 * 10.1 ↘ 10.4 * 10.8 *
 beste Teiler 32.3 (10.) 88.4 (4.) 102.7 (6.)
 Trefferlage 0.80 mm rechts, 0.54 mm hoch
 Streuwert 1.20, horizontal: 0.84, vertikal: 1.47

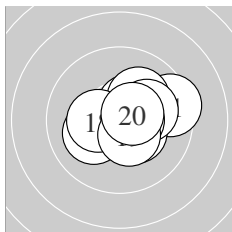

Serie 2:
 9.4 → 10.5 * 10.4 * 10.1 ↗ 10.1 →
 10.1 ← 10.6 * 10.3 * 10.5 * 10.5 *
 beste Teiler 96.0 (17.) 102.4 (20.) 120.7 (12.)
 Trefferlage 0.78 mm rechts, 0.19 mm hoch
 Streuwert 1.29, horizontal: 1.58, vertikal: 0.92

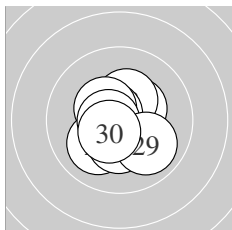

Serie 3:
 10.6 * 10.4 * 10.3 * 10.7 * 10.4 *
 10.0 ↘ 10.3 * 10.6 * 9.9 ↘ 10.5 *
 beste Teiler 75.0 (24.) 80.2 (28.) 91.5 (21.)
 Trefferlage 0.16 mm links, 0.31 mm tief
 Streuwert 1.11, horizontal: 1.05, vertikal: 1.16

Unterschrift des Schützen

Ergebnis: **309.4** (299)
 Serien: 103.9 102.6 102.9
 Zähler: 29 1 0 0 0 0 0 0 0 0
 Innenzehner: 22
 weiteste: 283 (28), 245 (22), 242 (14)
 beste Teiler 53.0 (21.) 87.6 (5.) 93.3 (4.)
 Trefferlage 0.35 mm rechts, 0.34 mm hoch
 Streuwert 1.17, horizontal: 1.23, vertikal: 1.12

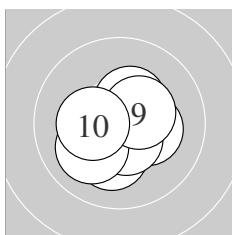
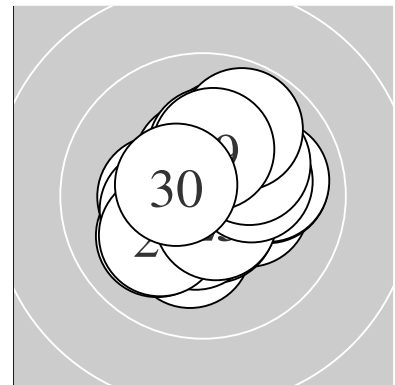

Serie 1:
 10.2 * 10.5 * 10.3 * 10.6 * 10.6 *
 10.4 * 10.5 * 10.1 ↙ 10.4 * 10.3 *
 beste Teiler 87.6 (5.) 93.3 (4.) 103.4 (7.)
 Trefferlage 0.23 mm links, 0.37 mm tief
 Streuwert 1.05, horizontal: 1.16, vertikal: 0.93

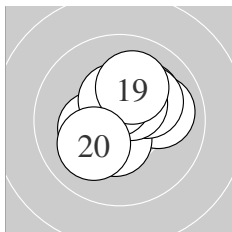

Serie 2:
 10.1 ↗ 10.3 * 10.3 * 10.0 → 10.5 *
 10.2 * 10.5 * 10.5 * 10.1 ↑ 10.1 ↙
 beste Teiler 121.4 (17.) 123.0 (15.) 125.3 (18.)
 Trefferlage 0.48 mm rechts, 0.47 mm hoch
 Streuwert 1.26, horizontal: 1.37, vertikal: 1.15

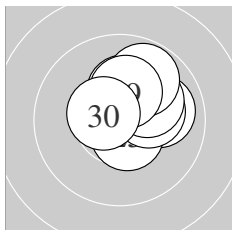

Serie 3:
 10.7 * 10.0 → 10.3 * 10.4 * 10.6 *
 10.2 * 10.1 ↗ 9.8 ↗ 10.3 * 10.5 *
 beste Teiler 53.0 (21.) 97.1 (25.) 107.1 (30.)
 Trefferlage 0.81 mm rechts, 0.93 mm hoch
 Streuwert 0.96, horizontal: 1.01, vertikal: 0.92

Unterschrift des Schützen

Ergebnis: **309.0** (297)
 Serien: 103.5 102.6 102.9
 Zähler: 27 3 0 0 0 0 0 0 0 0
 Innenzehner: 23
 weiteste: 278 (8), 273 (16), 259 (30)
 beste Teiler 37.1 (24.) 57.4 (18.) 69.3 (4.)
 Trefferlage 0.25 mm rechts, 0.54 mm hoch
 Streuwert 1.19, horizontal: 1.37, vertikal: 0.97

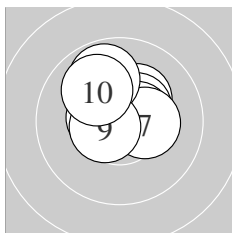
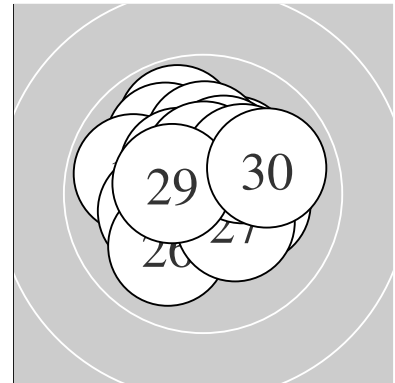

Serie 1:
 10.3 * 10.4 * 10.5 * 10.7 * 10.4 *
 10.5 * 10.3 * 9.8 ↖ 10.6 * 10.0 ↘
 beste Teiler 69.3 (4.) 98.7 (9.) 109.1 (3.)
 Trefferlage 0.14 mm links, 0.78 mm hoch
 Streuwert 1.07, horizontal: 1.17, vertikal: 0.96

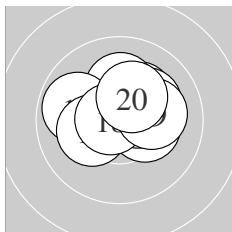

Serie 2:
 10.2 * 10.3 * 10.2 * 10.2 * 10.5 *
 9.9 ↖ 10.2 * 10.7 * 10.1 → 10.3 *
 beste Teiler 57.4 (18.) 125.9 (15.) 163.7 (12.)
 Trefferlage 0.34 mm rechts, 0.66 mm hoch
 Streuwert 1.25, horizontal: 1.55, vertikal: 0.85

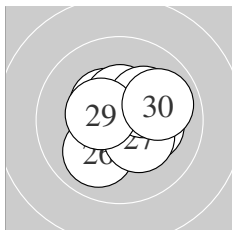

Serie 3:
 10.1 → 10.4 * 10.2 * 10.8 * 10.5 *
 10.0 ↙ 10.3 * 10.2 * 10.5 * 9.9 →
 beste Teiler 37.1 (24.) 123.3 (29.) 124.0 (25.)
 Trefferlage 0.56 mm rechts, 0.17 mm hoch
 Streuwert 1.25, horizontal: 1.40, vertikal: 1.08

Unterschrift des Schützen

Ergebnis: **309.6** (296)
 Serien: 103.7 104.0 101.9
 Zähler: 26 4 0 0 0 0 0 0 0 0
 Innenzehner: 22
 weiteste: 343 (21), 323 (25), 315 (11)
 beste Teiler 18.8 (20.) 40.2 (8.) 70.1 (22.)
 Trefferlage 0.44 mm links, 0.26 mm hoch
 Streuwert 1.24, horizontal: 1.44, vertikal: 1.01

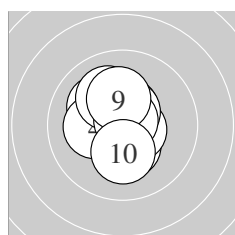
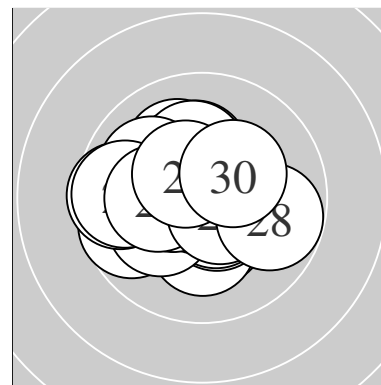

Serie 1:
 10.1 ↘ 10.4 * 10.5 * 10.2 * 10.6 *
 10.6 * 10.1 ↘ 10.8 * 10.2 * 10.2 *
 beste Teiler 40.2 (8.) 89.8 (5.) 100.8 (6.)
 Trefferlage 0.26 mm links, 0.36 mm hoch
 Streuwert 1.13, horizontal: 0.95, vertikal: 1.29

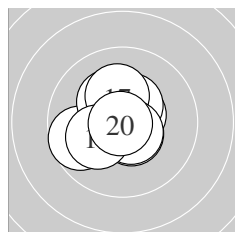

Serie 2:
 9.7 ← 10.5 * 10.7 * 10.6 * 10.4 *
 10.3 * 10.2 * 10.6 * 10.1 ← 10.9 *
 beste Teiler 18.8 (20.) 70.2 (13.) 91.5 (18.)
 Trefferlage 0.29 mm links, 0.14 mm hoch
 Streuwert 1.16, horizontal: 1.25, vertikal: 1.07

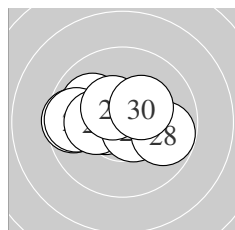

Serie 3:
 9.6 ← 10.7 * 10.5 * 10.0 ↘ 9.7 ←
 10.2 * 10.6 * 9.8 → 10.5 * 10.3 *
 beste Teiler 70.1 (22.) 92.6 (27.) 121.0 (23.)
 Trefferlage 0.76 mm links, 0.28 mm hoch
 Streuwert 1.50, horizontal: 2.01, vertikal: 0.67

Unterschrift des Schützen

Meyton Elektronik

Ergebnis: **308.2** (295)
 Serien: 103.7 101.7 102.8
 Zähler: 25 5 0 0 0 0 0 0 0 0
 Innenzehner: 21
 weiteste: 364 (14), 345 (26), 321 (20)
 beste Teiler 38.8 (6.) 40.0 (18.) 51.6 (21.)
 Trefferlage 0.81 mm links, 0.62 mm tief
 Streuwert 1.15, horizontal: 1.14, vertikal: 1.16

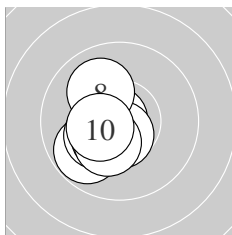
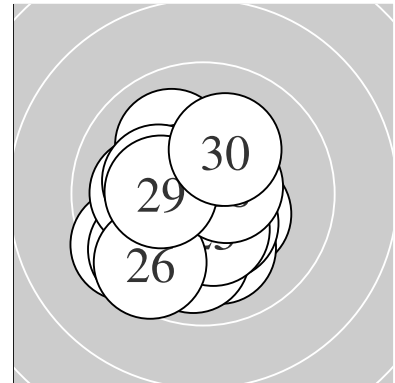

Serie 1:
 10.5 * 9.8 ↙ 10.3 * 10.4 * 10.6 *
 10.8 * 10.6 * 10.0 ↘ 10.3 * 10.4 *
 beste Teiler 38.8 (6.) 85.7 (5.) 90.0 (7.)
 Trefferlage 0.94 mm links, 0.60 mm tief
 Streuwert 0.86, horizontal: 0.62, vertikal: 1.05

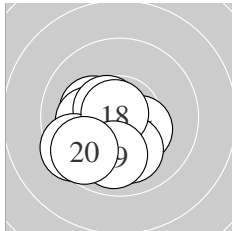

Serie 2:
 10.2 * 10.1 ← 10.6 * 9.5 ↙ 10.4 *
 10.4 * 10.1 ↓ 10.8 * 9.9 ↓ 9.7 ↙
 beste Teiler 40.0 (18.) 99.6 (13.) 129.6 (16.)
 Trefferlage 0.91 mm links, 0.98 mm tief
 Streuwert 1.28, horizontal: 1.36, vertikal: 1.19

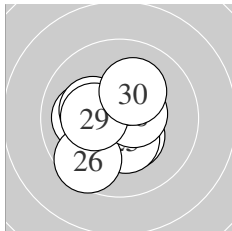

Serie 3:
 10.7 * 10.0 ← 10.4 * 10.4 * 10.4 *
 9.6 ↙ 10.2 * 10.6 * 10.3 * 10.2 *
 beste Teiler 51.6 (21.) 98.3 (28.) 139.5 (24.)
 Trefferlage 0.57 mm links, 0.27 mm tief
 Streuwert 1.30, horizontal: 1.37, vertikal: 1.23

Unterschrift des Schützen

Ergebnis: **309.3** (298)
 Serien: 103.0 102.8 103.5
 Zähler: 28 2 0 0 0 0 0 0 0 0
 Innenzehner: 21
 weiteste: 290 (22), 268 (7), 243 (11)
 beste Teiler 24.6 (27.) 54.2 (20.) 72.8 (29.)
 Trefferlage 0.62 mm links, 0.12 mm hoch
 Streuwert 1.16, horizontal: 1.04, vertikal: 1.27

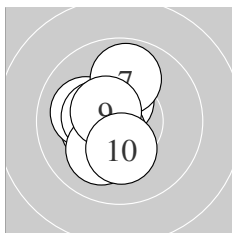
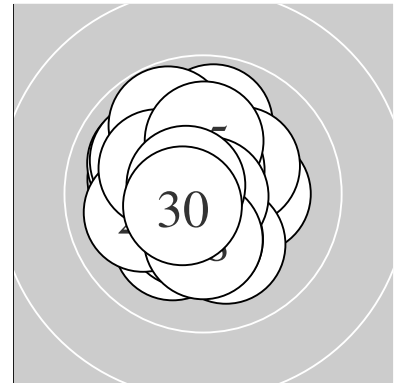

Serie 1:
 10.3 * 10.4 * 10.4 * 10.1 ↖ 10.4 *
 10.6 * 9.9 ↑ 10.1 ↙ 10.5 * 10.3 *
 beste Teiler 92.8 (6.) 105.6 (9.) 127.2 (3.)
 Trefferlage 0.77 mm links, 0.04 mm tief
 Streuwert 1.14, horizontal: 0.79, vertikal: 1.40

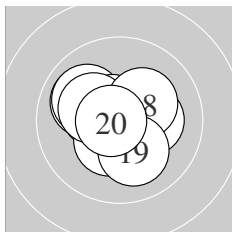

Serie 2:
 10.0 ↘ 10.2 * 10.4 * 10.0 ↘ 10.6 *
 10.4 * 10.2 * 10.2 * 10.1 ↓ 10.7 *
 beste Teiler 54.2 (20.) 78.0 (15.) 143.5 (16.)
 Trefferlage 0.47 mm links, 0.20 mm hoch
 Streuwert 1.25, horizontal: 1.42, vertikal: 1.06

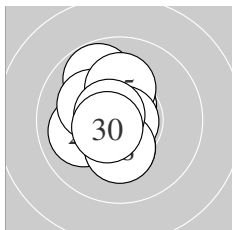

Serie 3:
 10.6 * 9.8 ↘ 10.0 ← 10.2 * 10.1 ↑
 10.3 * 10.9 * 10.3 * 10.7 * 10.6 *
 beste Teiler 24.6 (27.) 72.8 (29.) 90.0 (30.)
 Trefferlage 0.63 mm links, 0.21 mm hoch
 Streuwert 1.19, horizontal: 0.88, vertikal: 1.44

Unterschrift des Schützen

Ergebnis: **293.6** (279)
 Serien: 99.1 99.2 95.3
 Zähler: 16 7 7 0 0 0 0 0 0 0
 Innenzehner: 11
 weiteste: 661 (30), 571 (28), 551 (22)
 beste Teiler 9.0 (8.) 82.5 (25.) 117.2 (12.)
 Trefferlage 0.30 mm links, 0.61 mm hoch
 Streuwert 2.36, horizontal: 2.50, vertikal: 2.22

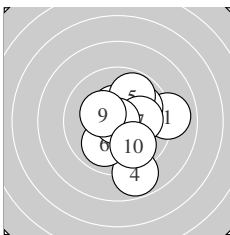
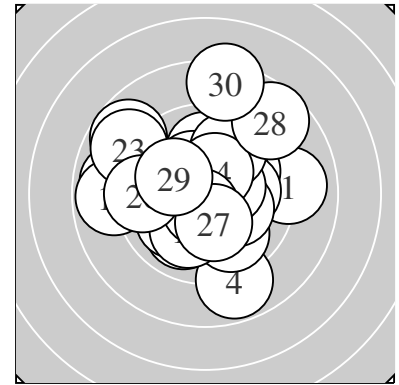

Serie 1:
 9.0 → 9.9 ↗ 10.4 * 8.8 ↘ 9.8 ↗
 10.0 ↙ 10.1 → 10.9 * 10.3 * 9.9 ↘
 beste Teiler 9.0 (8.) 128.0 (3.) 159.2 (9.)
 Trefferlage 1.07 mm rechts, 0.30 mm tief
 Streuwert 2.06, horizontal: 1.89, vertikal: 2.21

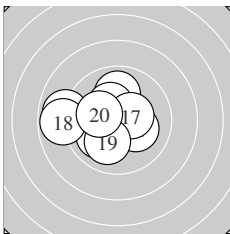

Serie 2:
 10.2 * 10.5 * 9.9 ↑ 8.9 ← 10.0 ↙
 10.3 * 10.4 * 8.8 ← 10.0 ↙ 10.2 *
 beste Teiler 117.2 (12.) 135.0 (17.) 158.7 (16.)
 Trefferlage 1.26 mm links, 0.22 mm hoch
 Streuwert 1.94, horizontal: 2.36, vertikal: 1.39

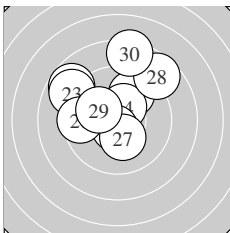

Serie 3:
 9.8 ↗ 8.7 ↘ 8.9 ↘ 10.4 * 10.6 *
 9.5 ← 10.3 * 8.7 ↗ 10.1 ↘ 8.3 ↑
 beste Teiler 82.5 (25.) 141.9 (24.) 174.3 (27.)
 Trefferlage 0.72 mm links, 1.90 mm hoch
 Streuwert 2.62, horizontal: 2.77, vertikal: 2.46

Unterschrift des Schützen

Ergebnis: **309.5** (295)
 Serien: 102.5 103.4 103.6
 Zähler: 25 5 0 0 0 0 0 0 0 0
 Innenzehner: 21
 weiteste: 342 (19), 295 (2), 278 (23)
 beste Teiler 28.1 (29.) 38.2 (10.) 47.5 (18.)
 Trefferlage 0.04 mm rechts, 0.37 mm hoch
 Streuwert 1.23, horizontal: 1.28, vertikal: 1.18

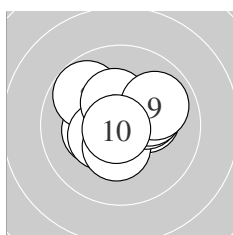
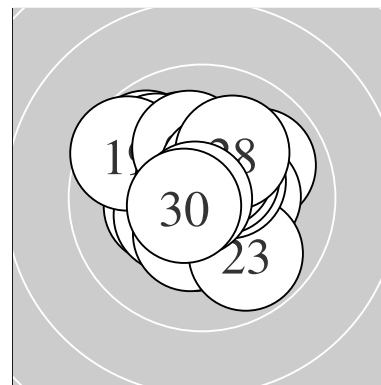

Serie 1:
 10.3 * 9.8 ↘ 10.4 * 10.3 * 10.4 *
 10.2 * 10.1 ↗ 10.3 * 9.9 ↗ 10.8 *
 beste Teiler 38.2 (10.) 140.5 (3.) 143.5 (5.)
 Trefferlage 0.13 mm rechts, 0.40 mm hoch
 Streuwert 1.36, horizontal: 1.60, vertikal: 1.06

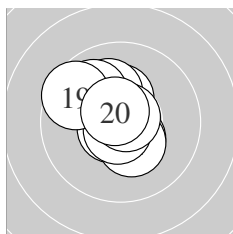

Serie 2:
 10.3 * 10.4 * 10.7 * 10.3 * 10.1 ↖
 10.7 * 9.9 ↘ 10.8 * 9.6 ↘ 10.6 *
 beste Teiler 47.5 (18.) 54.7 (16.) 73.2 (13.)
 Trefferlage 0.49 mm links, 0.47 mm hoch
 Streuwert 1.20, horizontal: 1.14, vertikal: 1.26

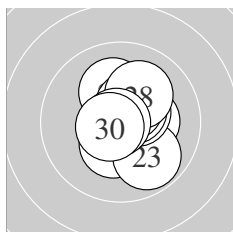

Serie 3:
 10.4 * 10.3 * 9.8 ↘ 10.5 * 10.1 ↖
 10.5 * 10.5 * 10.1 ↗ 10.8 * 10.6 *
 beste Teiler 28.1 (29.) 77.4 (30.) 113.8 (26.)
 Trefferlage 0.50 mm rechts, 0.23 mm hoch
 Streuwert 1.14, horizontal: 0.92, vertikal: 1.32

Unterschrift des Schützen

Ergebnis: **301.5** (288)
 Serien: 101.2 102.3 98.0
 Zähler: 19 10 1 0 0 0 0 0 0 0
 Innenzehner: 13
 weiteste: 558 (30), 455 (24), 392 (22)
 beste Teiler 8.0 (15.) 36.0 (2.) 57.3 (12.)
 Trefferlage 0.80 mm rechts, 1.01 mm hoch
 Streuwert 1.60, horizontal: 1.67, vertikal: 1.52

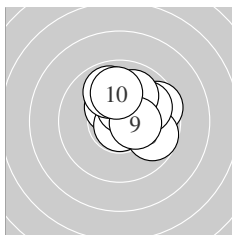
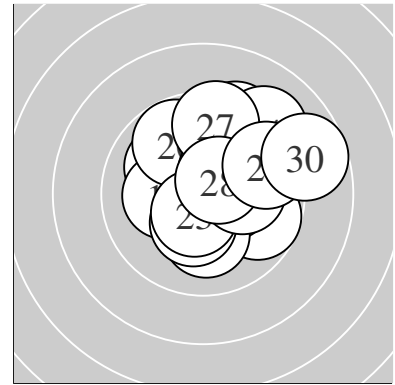

Serie 1:
 10.4 * 10.8 * 10.5 * 9.6 → 9.7 →
 9.9 ↗ 10.0 ↗ 9.9 ↘ 10.4 * 10.0 ↑
 beste Teiler 36.0 (2.) 123.2 (3.) 136.9 (9.)
 Trefferlage 0.91 mm rechts, 1.02 mm hoch
 Streuwert 1.36, horizontal: 1.48, vertikal: 1.23

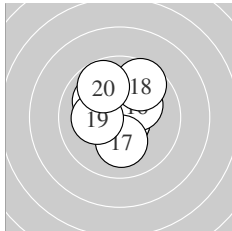

Serie 2:
 10.7 * 10.7 * 10.0 ↘ 10.1 ↘ 10.9 *
 10.2 * 10.1 ↓ 9.6 ↗ 10.2 * 9.8 ↘
 beste Teiler 8.0 (15.) 57.3 (12.) 58.6 (11.)
 Trefferlage 0.18 mm links, 0.68 mm hoch
 Streuwert 1.42, horizontal: 1.29, vertikal: 1.55

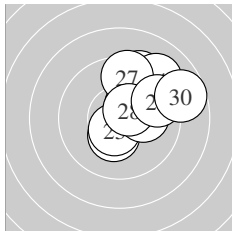

Serie 3:
 10.3 * 9.4 ↗ 10.5 * 9.1 ↗ 10.1 →
 10.4 * 9.5 ↑ 10.5 * 9.5 → 8.7 →
 beste Teiler 107.7 (28.) 108.3 (23.) 149.0 (26.)
 Trefferlage 1.68 mm rechts, 1.33 mm hoch
 Streuwert 1.80, horizontal: 1.80, vertikal: 1.80

Unterschrift des Schützen

Ergebnis: **312.8** (296)
 Serien: 104.4 104.5 103.9
 Zähler: 26 4 0 0 0 0 0 0 0 0
 Innenzehner: 25
 weiteste: 329 (26), 292 (18), 253 (3)
 beste Teiler 17.0 (10.) 33.4 (27.) 33.6 (30.)
 Trefferlage 0.01 mm links, 0.14 mm hoch
 Streuwert 1.10, horizontal: 1.21, vertikal: 0.99

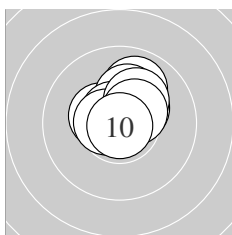
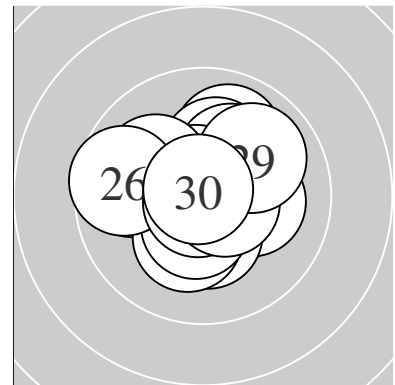

Serie 1:
 10.3 * 10.4 * 9.9 ↗ 10.2 * 10.8 *
 10.7 * 10.6 * 10.2 * 10.4 * 10.9 *
 beste Teiler 17.0 (10.) 49.2 (5.) 74.6 (6.)
 Trefferlage 0.19 mm rechts, 0.87 mm hoch
 Streuwert 0.85, horizontal: 0.90, vertikal: 0.79

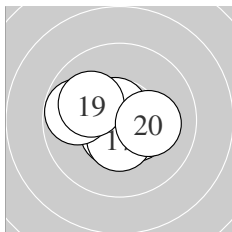

Serie 2:
 10.7 * 10.7 * 10.6 * 10.7 * 10.5 *
 10.7 * 10.5 * 9.8 ← 10.1 ↖ 10.2 *
 beste Teiler 63.5 (14.) 64.1 (12.) 68.0 (11.)
 Trefferlage 0.19 mm links, 0.20 mm tief
 Streuwert 1.11, horizontal: 1.39, vertikal: 0.75

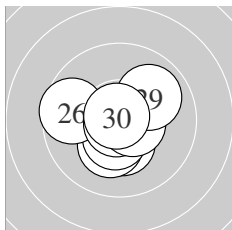

Serie 3:
 10.7 * 10.3 * 10.5 * 10.2 * 10.5 *
 9.6 ← 10.8 * 10.6 * 9.9 ↗ 10.8 *
 beste Teiler 33.4 (27.) 33.6 (30.) 52.0 (21.)
 Trefferlage 0.04 mm links, 0.24 mm tief
 Streuwert 1.21, horizontal: 1.37, vertikal: 1.02

Unterschrift des Schützen

Ergebnis: **308.3** (292)
 Serien: 104.1 104.0 100.2
 Zähler: 22 8 0 0 0 0 0 0 0 0
 Innenzehner: 18
 weiteste: 467 (29), 398 (18), 363 (11)
 beste Teiler 23.0 (16.) 35.1 (19.) 39.3 (23.)
 Trefferlage 0.18 mm rechts, 0.07 mm hoch
 Streuwert 1.50, horizontal: 1.88, vertikal: 0.98

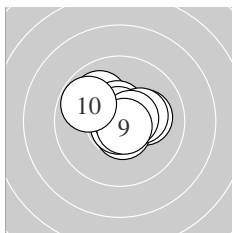
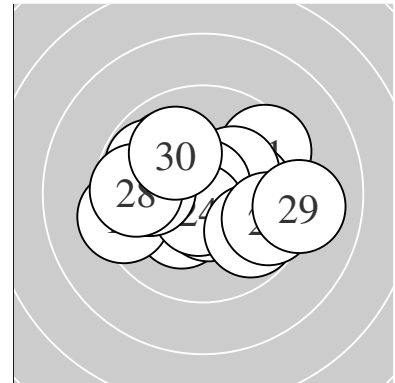

Serie 1:
 10.1 → 10.0 ↘ 10.6 * 10.8 * 10.5 *
 10.3 * 10.7 * 10.6 * 10.7 * 9.8 ↖
 beste Teiler 42.2 (4.) 55.1 (7.) 55.2 (9.)
 Trefferlage 0.07 mm rechts, 0.40 mm hoch
 Streuwert 1.13, horizontal: 1.36, vertikal: 0.83

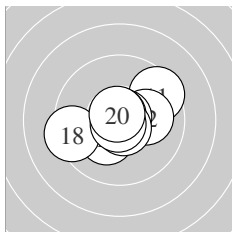

Serie 2:
 9.5 ↗ 10.1 → 10.3 * 10.8 * 10.8 *
 10.9 * 10.7 * 9.4 ← 10.8 * 10.7 *
 beste Teiler 23.0 (16.) 35.1 (19.) 40.4 (14.)
 Trefferlage 0.04 mm rechts, 0.02 mm tief
 Streuwert 1.45, horizontal: 1.81, vertikal: 0.96

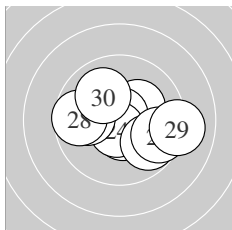

Serie 3:
 10.2 * 10.5 * 10.8 * 10.6 * 9.9 ←
 9.8 ↘ 9.6 ↘ 9.7 ← 9.1 → 10.0 ↘
 beste Teiler 39.3 (23.) 78.1 (24.) 104.5 (22.)
 Trefferlage 0.44 mm rechts, 0.15 mm tief
 Streuwert 1.93, horizontal: 2.49, vertikal: 1.13

Unterschrift des Schützen

Ergebnis: **289.2** (278)
 Serien: 91.9 98.6 98.7
 Zähler: 17 7 4 1 1 0 0 0 0 0
 Innenzehner: 13
 weiteste: 1154 (8), 929 (1), 740 (13)
 beste Teiler 47.0 (20.) 98.4 (16.) 115.0 (23.)
 Trefferlage 1.78 mm rechts, 0.31 mm tief
 Streuwert 2.74, horizontal: 3.62, vertikal: 1.37

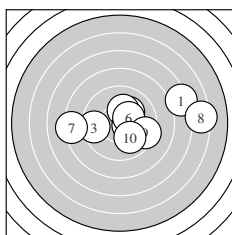
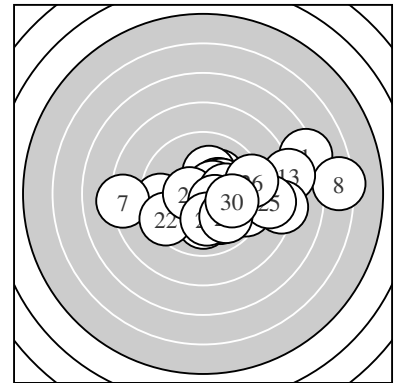

Serie 1:
 7.2 → 10.2 * 9.5 ← 10.2 * 10.5 *
 10.4 * 8.2 ← 6.3 → 9.4 → 10.0 ↘
 beste Teiler 120.5 (5.) 150.0 (6.) 189.7 (4.)
 Trefferlage 1.91 mm rechts, 0.34 mm hoch
 Streuwert 3.90, horizontal: 5.28, vertikal: 1.60

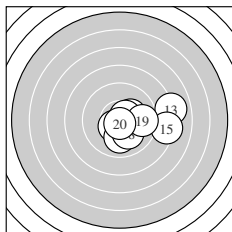

Serie 2:
 10.3 * 10.3 * 8.0 → 10.5 * 8.3 →
 10.6 * 10.0 ↓ 10.1 ↘ 9.7 → 10.8 *
 beste Teiler 47.0 (20.) 98.4 (16.) 116.7 (14.)
 Trefferlage 2.14 mm rechts, 0.46 mm tief
 Streuwert 2.13, horizontal: 2.76, vertikal: 1.21

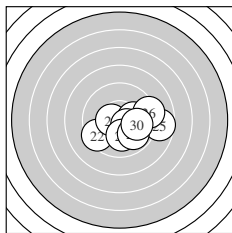

Serie 3:
 10.3 * 9.4 ↙ 10.5 * 10.2 * 8.7 →
 9.2 → 10.5 * 10.1 ↓ 9.9 ↘ 9.9 →
 beste Teiler 115.0 (23.) 117.8 (27.) 153.1 (21.)
 Trefferlage 1.30 mm rechts, 0.81 mm tief
 Streuwert 1.95, horizontal: 2.53, vertikal: 1.10

Unterschrift des Schützen

Ergebnis: **290.8** (278)
 Serien: 94.8 96.1 99.9
 Zähler: 14 11 4 1 0 0 0 0 0 0
 Innenzehner: 12
 weiteste: 798 (8), 717 (11), 686 (3)
 beste Teiler 92.8 (10.) 106.0 (4.) 119.1 (26.)
 Trefferlage 0.54 mm links, 1.09 mm hoch
 Streuwert 2.50, horizontal: 2.74, vertikal: 2.23

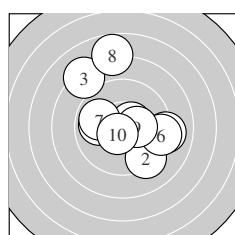
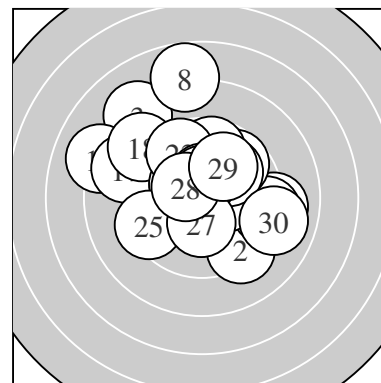

Serie 1:
 9.9 ← 9.3 ↘ 8.2 ↘ 10.5 * 9.1 →
 9.2 → 9.9 ← 7.8 ↑ 10.3 * 10.6 *
 beste Teiler 92.8 (10.) 106.0 (4.) 156.0 (9.)
 Trefferlage 0.29 mm rechts, 0.94 mm hoch
 Streuwert 3.14, horizontal: 3.00, vertikal: 3.28

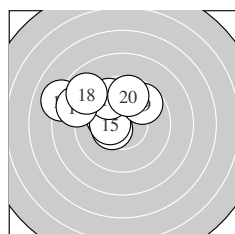

Serie 2:
 8.1 ↖ 10.2 * 10.4 * 10.2 * 10.4 *
 9.7 ↘ 8.8 ↖ 8.9 ↘ 9.7 ↗ 9.7 ↑
 beste Teiler 127.0 (13.) 137.0 (15.) 183.5 (12.)
 Trefferlage 1.99 mm links, 1.74 mm hoch
 Streuwert 2.07, horizontal: 2.60, vertikal: 1.33

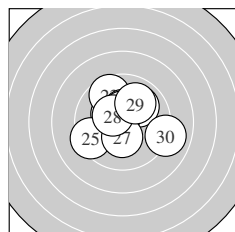

Serie 3:
 10.3 * 10.0 ↗ 9.6 ↘ 10.4 * 9.4 ←
 10.5 * 10.3 * 10.4 * 10.0 ↗ 9.0 →
 beste Teiler 119.1 (26.) 128.9 (28.) 134.2 (24.)
 Trefferlage 0.07 mm rechts, 0.59 mm hoch
 Streuwert 1.95, horizontal: 2.21, vertikal: 1.66

Unterschrift des Schützen

Ergebnis: **304.0** (292)
 Serien: 100.1 101.6 102.3
 Zähler: 23 6 1 0 0 0 0 0 0 0
 Innenzehner: 15
 weiteste: 575 (3), 417 (20), 336 (11)
 beste Teiler 19.4 (14.) 55.3 (12.) 74.8 (9.)
 Trefferlage 0.48 mm rechts, 0.38 mm hoch
 Streuwert 1.63, horizontal: 1.94, vertikal: 1.24

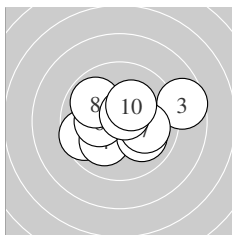
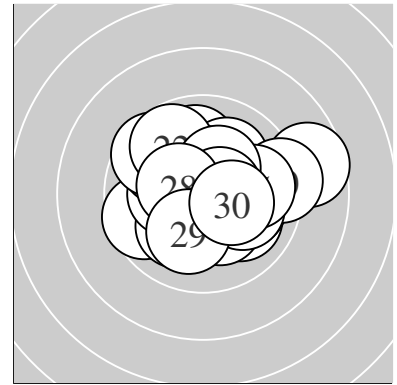

Serie 1:
 9.6 ← 10.6 * 8.7 → 10.1 ✓ 10.0 ↘
 10.2 * 10.0 → 9.9 ↖ 10.7 * 10.3 *
 beste Teiler 74.8 (9.) 76.8 (2.) 173.2 (10.)
 Trefferlage 0.22 mm rechts, 0.01 mm tief
 Streuwert 2.03, horizontal: 2.58, vertikal: 1.25

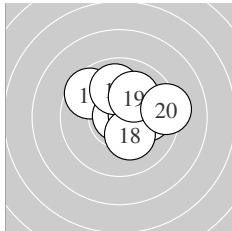

Serie 2:
 9.6 ↘ 10.7 * 10.3 * 10.9 * 10.0 →
 10.5 * 10.0 ↑ 10.2 * 10.1 ↗ 9.3 →
 beste Teiler 19.4 (14.) 55.3 (12.) 125.1 (16.)
 Trefferlage 0.82 mm rechts, 0.76 mm hoch
 Streuwert 1.51, horizontal: 1.79, vertikal: 1.18

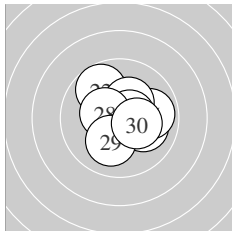

Serie 3:
 10.3 * 9.7 ↘ 10.6 * 10.1 → 9.9 →
 10.3 * 10.6 * 10.4 * 10.1 ↓ 10.3 *
 beste Teiler 92.1 (27.) 94.3 (23.) 136.2 (28.)
 Trefferlage 0.40 mm rechts, 0.41 mm hoch
 Streuwert 1.37, horizontal: 1.45, vertikal: 1.28

Unterschrift des Schützen

Ergebnis: **305.2** (290)
 Serien: 102.6 101.7 100.9
 Zähler: 20 10 0 0 0 0 0 0 0 0
 Innenzehner: 15
 weiteste: 344 (30), 335 (24), 332 (5)
 beste Teiler 35.1 (11.) 37.1 (2.) 44.4 (16.)
 Trefferlage 0.46 mm rechts, 0.45 mm tief
 Streuwert 1.47, horizontal: 1.64, vertikal: 1.28

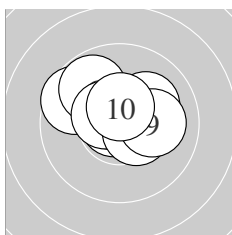
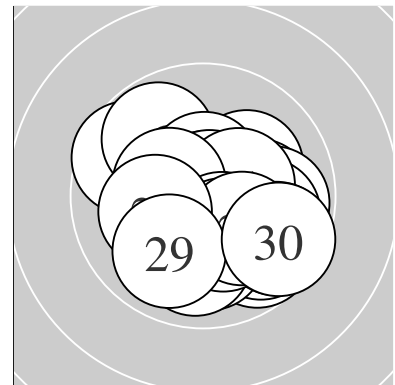

Serie 1:
 10.1 ↘ 10.8 * 10.6 * 10.1 ↗ 9.6 ↖
 9.8 ↘ 10.5 * 10.5 * 10.1 → 10.5 *
 beste Teiler 37.1 (2.) 81.5 (3.) 108.1 (10.)
 Trefferlage 0.33 mm links, 0.79 mm hoch
 Streuwert 1.29, horizontal: 1.63, vertikal: 0.83

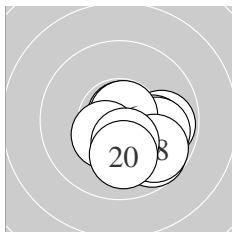

Serie 2:
 10.8 * 9.8 → 9.7 ↘ 10.1 → 9.9 →
 10.8 * 10.4 * 9.8 ↘ 10.4 * 10.0 ↓
 beste Teiler 35.1 (11.) 44.4 (16.) 135.0 (17.)
 Trefferlage 1.18 mm rechts, 0.96 mm tief
 Streuwert 1.14, horizontal: 1.30, vertikal: 0.96

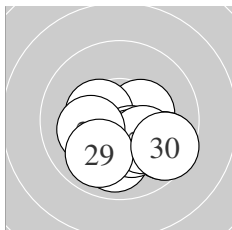

Serie 3:
 10.4 * 9.9 ↓ 10.4 * 9.6 ↘ 10.4 *
 10.3 * 10.2 * 10.2 * 9.9 ↙ 9.6 ↘
 beste Teiler 141.3 (23.) 145.7 (21.) 149.5 (25.)
 Trefferlage 0.54 mm rechts, 1.19 mm tief
 Streuwert 1.42, horizontal: 1.74, vertikal: 1.00

Unterschrift des Schützen

Ergebnis: **306.4** (292)
 Serien: 102.7 101.0 102.7
 Zähler: 22 8 0 0 0 0 0 0 0 0
 Innenzehner: 19
 weiteste: 352 (18), 342 (16), 283 (5)
 beste Teiler 22.5 (28.) 35.6 (19.) 80.2 (12.)
 Trefferlage 0.59 mm rechts, 0.34 mm hoch
 Streuwert 1.36, horizontal: 1.45, vertikal: 1.27

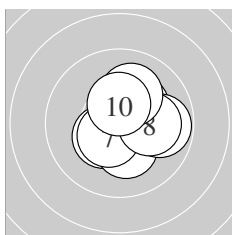
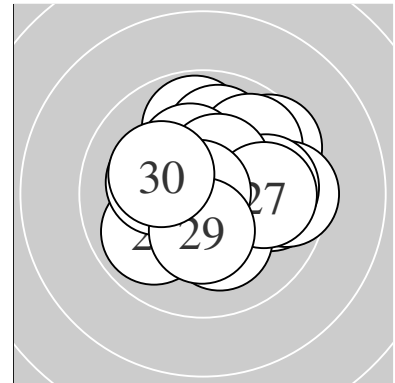

Serie 1:
 10.3 * 10.4 * 10.4 * 10.3 * 9.8 →
 10.4 * 10.5 * 10.1 → 10.1 ↑ 10.4 *
 beste Teiler 115.5 (7.) 131.0 (6.) 134.3 (2.)
 Trefferlage 0.68 mm rechts, 0.27 mm hoch
 Streuwert 1.21, horizontal: 1.22, vertikal: 1.20

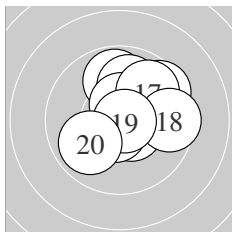

Serie 2:
 10.5 * 10.6 * 9.8 ↑ 10.0 ↑ 10.5 *
 9.6 ↗ 9.8 ↗ 9.5 → 10.8 * 9.9 ↙
 beste Teiler 35.6 (19.) 80.2 (12.) 106.0 (11.)
 Trefferlage 0.74 mm rechts, 0.71 mm hoch
 Streuwert 1.58, horizontal: 1.64, vertikal: 1.52

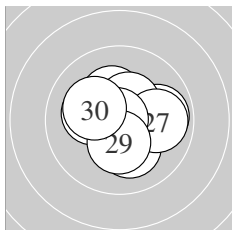

Serie 3:
 10.2 * 10.4 * 10.2 * 10.3 * 9.9 →
 10.4 * 9.9 → 10.9 * 10.3 * 10.2 *
 beste Teiler 22.5 (28.) 131.1 (26.) 136.3 (22.)
 Trefferlage 0.34 mm rechts, 0.05 mm hoch
 Streuwert 1.36, horizontal: 1.57, vertikal: 1.10

Unterschrift des Schützen

Ergebnis: **304.8** (291)
 Serien: 97.7 103.9 103.2
 Zähler: 22 7 1 0 0 0 0 0 0 0
 Innenzehner: 17
 weiteste: 507 (9), 471 (1), 448 (2)
 beste Teiler 15.8 (15.) 29.0 (27.) 37.6 (11.)
 Trefferlage 0.32 mm links, 0.35 mm hoch
 Streuwert 1.68, horizontal: 1.96, vertikal: 1.35

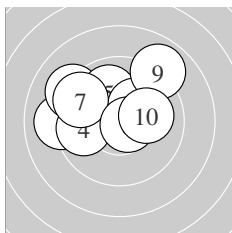
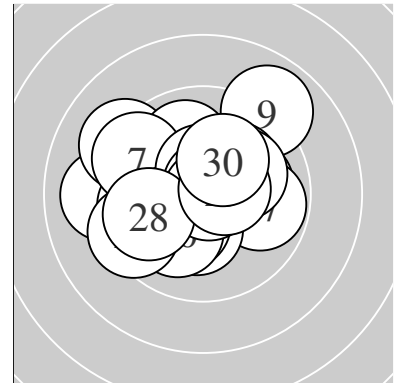

Serie 1:
 9.1 ← 9.2 ↘ 10.2 * 9.8 ← 10.0 ↗
 10.2 * 9.5 ↘ 10.7 * 8.9 ↗ 10.1 →

beste Teiler 71.6 (8.) 179.6 (6.) 200.6 (3.)
 Trefferlage 0.99 mm links, 1.23 mm hoch
 Streuwert 2.16, horizontal: 2.69, vertikal: 1.43

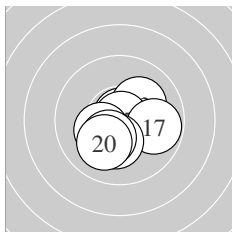

Serie 2:
 10.8 * 10.6 * 10.1 ↗ 10.7 * 10.9 *
 10.3 * 9.8 → 10.3 * 10.3 * 10.1 ↙

beste Teiler 15.8 (15.) 37.6 (11.) 65.3 (14.)
 Trefferlage 0.13 mm rechts, 0.52 mm tief
 Streuwert 1.15, horizontal: 1.30, vertikal: 0.98

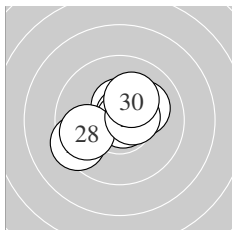

Serie 3:
 10.6 * 10.5 * 9.4 ↙ 10.1 ↗ 10.5 *
 10.8 * 10.8 * 9.8 ↙ 10.5 * 10.2 *

beste Teiler 29.0 (27.) 50.2 (26.) 94.1 (21.)
 Trefferlage 0.10 mm links, 0.34 mm hoch
 Streuwert 1.38, horizontal: 1.64, vertikal: 1.07

Unterschrift des Schützen

Ergebnis: **312.3** (298)
 Serien: 102.5 103.8 106.0
 Zähler: 28 2 0 0 0 0 0 0 0 0
 Innenzehner: 27
 weiteste: 347 (8), 284 (6), 218 (17)
 beste Teiler 45.1 (23.) 48.1 (24.) 54.3 (15.)
 Trefferlage 0.12 mm links, 0.28 mm hoch
 Streuwert 1.06, horizontal: 1.21, vertikal: 0.89

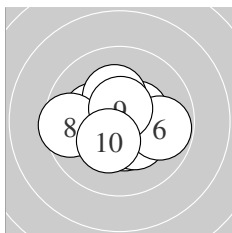
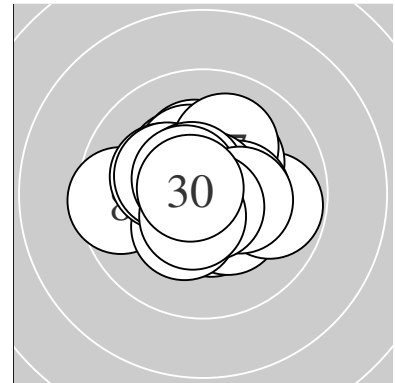

Serie 1:
 10.4 * 10.6 * 10.4 * 10.2 * 10.3 *
 9.8 → 10.3 * 9.6 ← 10.6 * 10.3 *
 beste Teiler 77.0 (2.) 89.2 (9.) 128.5 (1.)
 Trefferlage 0.13 mm links, 0.15 mm tief
 Streuwert 1.41, horizontal: 1.71, vertikal: 1.03

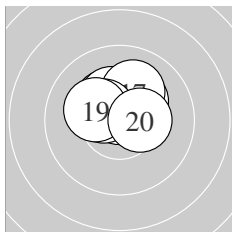

Serie 2:
 10.3 * 10.6 * 10.2 * 10.3 * 10.7 *
 10.6 * 10.1 ↗ 10.4 * 10.2 * 10.4 *
 beste Teiler 54.3 (15.) 93.0 (16.) 96.0 (12.)
 Trefferlage 0.02 mm links, 0.97 mm hoch
 Streuwert 0.84, horizontal: 1.04, vertikal: 0.56

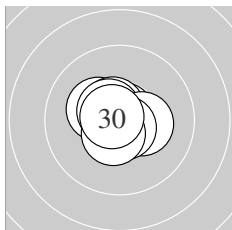

Serie 3:
 10.7 * 10.3 * 10.8 * 10.8 * 10.6 *
 10.6 * 10.3 * 10.7 * 10.5 * 10.7 *
 beste Teiler 45.1 (23.) 48.1 (24.) 59.0 (30.)
 Trefferlage 0.21 mm links, 0.02 mm hoch
 Streuwert 0.72, horizontal: 0.81, vertikal: 0.62

Unterschrift des Schützen

Ergebnis: **313.9** (298)
 Serien: 105.7 104.4 103.8
 Zähler: 28 2 0 0 0 0 0 0 0 0
 Innenzehner: 27
 weiteste: 349 (30), 258 (18), 210 (29)
 beste Teiler 14.1 (6.) 25.9 (3.) 25.9 (26.)
 Trefferlage 0.32 mm links, 0.55 mm tief
 Streuwert 0.90, horizontal: 0.97, vertikal: 0.83

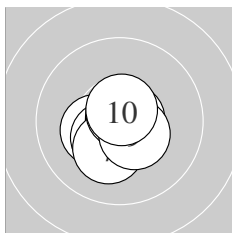
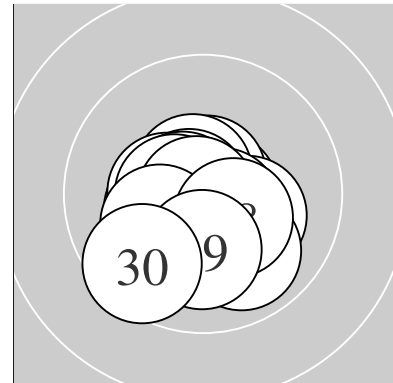

Serie 1:
 10.7 * 10.4 * 10.9 * 10.3 * 10.4 *
 10.9 * 10.2 * 10.7 * 10.5 * 10.7 *
 beste Teiler 14.1 (6.) 25.9 (3.) 55.5 (8.)
 Trefferlage 0.24 mm links, 0.35 mm tief
 Streuwert 0.76, horizontal: 0.78, vertikal: 0.74

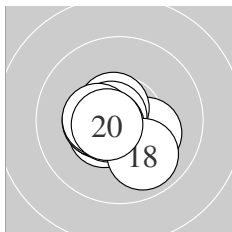

Serie 2:
 10.5 * 10.2 * 10.6 * 10.7 * 10.5 *
 10.4 * 10.6 * 9.9 ↘ 10.4 * 10.6 *
 beste Teiler 56.6 (14.) 78.7 (17.) 83.8 (20.)
 Trefferlage 0.42 mm links, 0.35 mm tief
 Streuwert 0.95, horizontal: 1.10, vertikal: 0.77

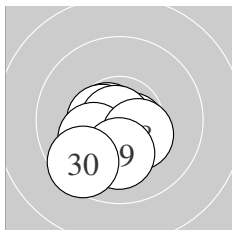

Serie 3:
 10.5 * 10.6 * 10.4 * 10.6 * 10.5 *
 10.9 * 10.2 * 10.4 * 10.1 ↓ 9.6 ↙
 beste Teiler 25.9 (26.) 77.6 (24.) 85.0 (22.)
 Trefferlage 0.31 mm links, 0.94 mm tief
 Streuwert 1.01, horizontal: 1.11, vertikal: 0.90

Unterschrift des Schützen

Ergebnis: **309.3** (296)
 Serien: 102.5 104.6 102.2
 Zähler: 26 4 0 0 0 0 0 0 0 0
 Innenzehner: 22
 weiteste: 322 (8), 322 (28), 255 (11)
 beste Teiler 16.1 (23.) 62.9 (20.) 68.2 (3.)
 Trefferlage 0.03 mm rechts, 0.07 mm tief
 Streuwert 1.29, horizontal: 1.47, vertikal: 1.07

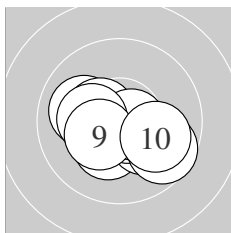
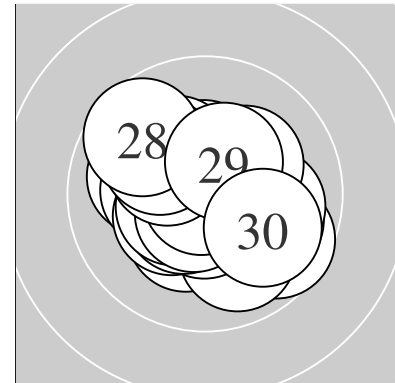

Serie 1:
 10.3 * 10.2 * 10.7 * 10.0 ↖ 10.4 *
 10.6 * 10.3 * 9.7 ↘ 10.3 * 10.0 ↘
 beste Teiler 68.2 (3.) 76.6 (6.) 132.7 (5.)
 Trefferlage 0.05 mm rechts, 0.55 mm tief
 Streuwert 1.37, horizontal: 1.75, vertikal: 0.83

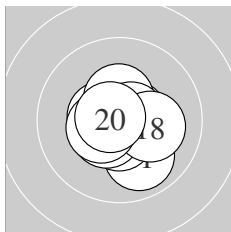

Serie 2:
 9.9 ↘ 10.6 * 10.5 * 10.6 * 10.5 *
 10.4 * 10.7 * 10.2 * 10.5 * 10.7 *
 beste Teiler 62.9 (20.) 74.2 (17.) 83.8 (14.)
 Trefferlage 0.09 mm rechts, 0.26 mm tief
 Streuwert 1.00, horizontal: 1.05, vertikal: 0.96

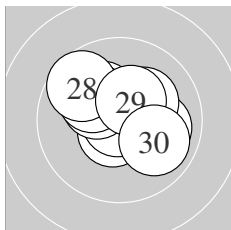

Serie 3:
 10.2 * 10.6 * 10.9 * 10.0 → 10.2 *
 10.1 ↖ 10.2 * 9.7 ↖ 10.4 * 9.9 ↘
 beste Teiler 16.1 (23.) 84.7 (22.) 142.5 (29.)
 Trefferlage 0.04 mm links, 0.59 mm hoch
 Streuwert 1.43, horizontal: 1.68, vertikal: 1.14

Unterschrift des Schützen

Ergebnis: **309.5** (294)
 Serien: 102.4 103.8 103.3
 Zähler: 24 6 0 0 0 0 0 0 0 0
 Innenzehner: 20
 weiteste: 371 (2), 309 (11), 294 (10)
 beste Teiler 32.7 (17.) 43.4 (26.) 46.0 (6.)
 Trefferlage 0.34 mm links, 0.28 mm hoch
 Streuwert 1.28, horizontal: 1.41, vertikal: 1.14

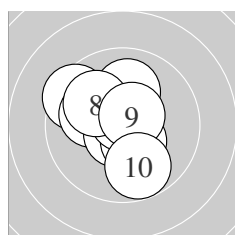
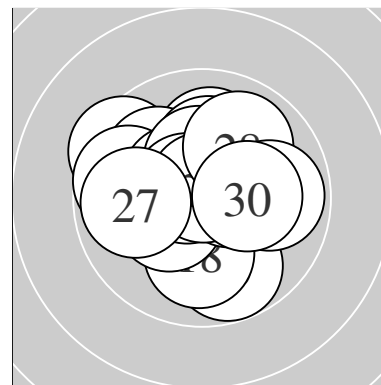

Serie 1:
 10.5 * 9.5 ↖ 10.1 ↖ 10.7 * 10.4 *
 10.8 * 10.0 ↑ 10.0 ↖ 10.6 * 9.8 ↓
 beste Teiler 46.0 (6.) 72.9 (4.) 91.2 (9.)
 Trefferlage 0.57 mm links, 0.32 mm hoch
 Streuwert 1.45, horizontal: 1.41, vertikal: 1.50

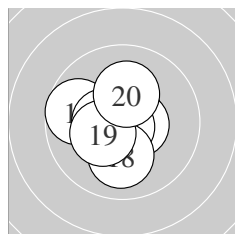

Serie 2:
 9.7 ↖ 10.6 * 10.4 * 10.6 * 10.6 *
 10.5 * 10.8 * 10.1 ↓ 10.3 * 10.2 *
 beste Teiler 32.7 (17.) 77.5 (12.) 92.3 (15.)
 Trefferlage 0.63 mm links, 0.08 mm tief
 Streuwert 1.11, horizontal: 1.14, vertikal: 1.08

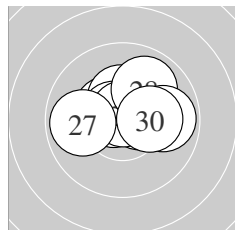

Serie 3:
 10.5 * 10.5 * 10.4 * 10.5 * 10.7 *
 10.8 * 9.9 ← 9.9 ↗ 9.9 → 10.2 *
 beste Teiler 43.4 (26.) 72.4 (25.) 117.2 (24.)
 Trefferlage 0.17 mm rechts, 0.60 mm hoch
 Streuwert 1.25, horizontal: 1.63, vertikal: 0.70

Unterschrift des Schützen

Meyton Elektronik

Ergebnis: **302.0** (290)
 Serien: 100.1 100.9 101.0
 Zähler: 20 10 0 0 0 0 0 0 0 0
 Innenzehner: 15
 weiteste: 404 (4), 389 (24), 372 (11)
 beste Teiler 54.4 (10.) 61.5 (20.) 73.8 (22.)
 Trefferlage 0.70 mm links, 0.94 mm tief
 Streuwert 1.54, horizontal: 1.60, vertikal: 1.49

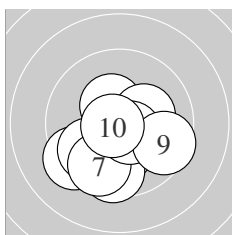
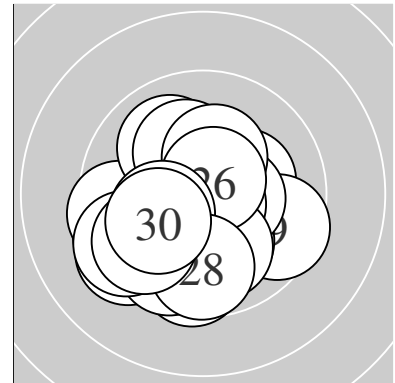

Serie 1:
 10.2 * 9.6 ↓ 10.4 * 9.3 ↙ 9.8 ↘
 10.2 * 9.7 ↙ 10.6 * 9.6 → 10.7 *
 beste Teiler 54.4 (10.) 99.0 (8.) 137.8 (3.)
 Trefferlage 0.25 mm links, 1.30 mm tief
 Streuwert 1.69, horizontal: 1.84, vertikal: 1.51

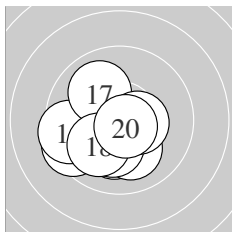

Serie 2:
 9.5 ↙ 10.2 * 10.1 ↓ 10.2 * 10.3 *
 9.5 ↙ 10.0 ↘ 10.0 ↙ 10.4 * 10.7 *
 beste Teiler 61.5 (20.) 127.4 (19.) 152.3 (15.)
 Trefferlage 0.96 mm links, 0.84 mm tief
 Streuwert 1.46, horizontal: 1.61, vertikal: 1.28

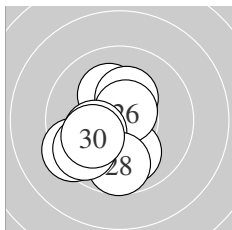

Serie 3:
 10.0 ↓ 10.7 * 10.2 * 9.4 ↙ 10.3 *
 10.7 * 10.2 * 9.7 ↓ 9.7 ↙ 10.1 ↙
 beste Teiler 73.8 (22.) 73.8 (26.) 163.5 (25.)
 Trefferlage 0.90 mm links, 0.69 mm tief
 Streuwert 1.56, horizontal: 1.38, vertikal: 1.72

Unterschrift des Schützen

Ergebnis: **307.2** (294)
 Serien: 102.8 103.9 100.5
 Zähler: 24 6 0 0 0 0 0 0 0 0
 Innenzehner: 19
 weiteste: 407 (24), 400 (4), 390 (28)
 beste Teiler 22.8 (25.) 34.2 (14.) 47.5 (1.)
 Trefferlage 0.33 mm links, 0.52 mm hoch
 Streuwert 1.43, horizontal: 1.43, vertikal: 1.43

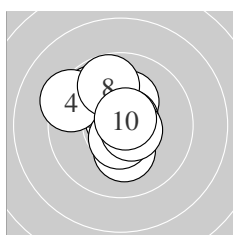
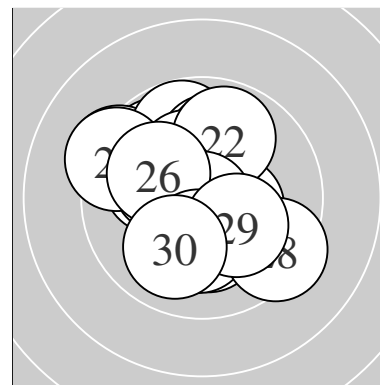

Serie 1:
 10.8 * 10.2 * 9.8 ↘ 9.4 ↖ 10.2 *
 10.7 * 10.6 * 9.8 ↑ 10.6 * 10.7 *
 beste Teiler 47.5 (1.) 57.0 (10.) 62.6 (6.)
 Trefferlage 0.43 mm links, 0.64 mm hoch
 Streuwert 1.42, horizontal: 1.38, vertikal: 1.46

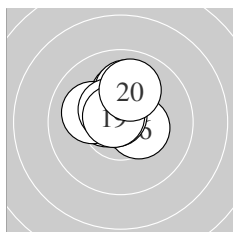

Serie 2:
 10.5 * 10.2 * 10.1 ↖ 10.8 * 10.0 ↑
 10.4 * 10.7 * 10.5 * 10.7 * 10.0 ↑
 beste Teiler 34.2 (14.) 58.0 (17.) 66.0 (19.)
 Trefferlage 0.22 mm links, 0.93 mm hoch
 Streuwert 0.93, horizontal: 0.95, vertikal: 0.92

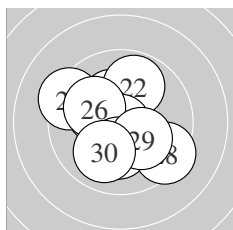

Serie 3:
 10.3 * 9.9 ↑ 10.2 * 9.3 ↖ 10.9 *
 10.1 ↖ 10.2 * 9.4 ↘ 10.2 * 10.0 ↙
 beste Teiler 22.8 (25.) 169.7 (21.) 178.3 (23.)
 Trefferlage 0.36 mm links, 0.00 mm
 Streuwert 1.86, horizontal: 1.94, vertikal: 1.77

Unterschrift des Schützen

Ergebnis: **294.2** (282)
 Serien: 99.2 96.1 98.9
 Zähler: 14 14 2 0 0 0 0 0 0 0
 Innenzehner: 11
 weiteste: 725 (14), 668 (17), 444 (1)
 beste Teiler 33.2 (30.) 49.2 (16.) 62.2 (19.)
 Trefferlage 1.24 mm rechts, 0.60 mm tief
 Streuwert 2.18, horizontal: 1.84, vertikal: 2.47

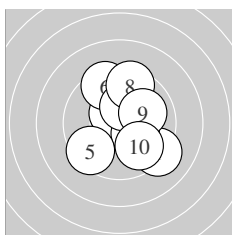
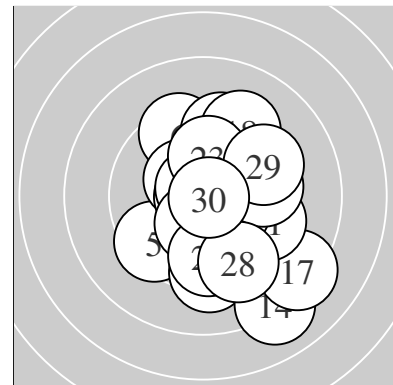

Serie 1:
 9.2 ↘ 10.6 * 10.5 * 10.3 * 9.5 ↙
 9.5 ↗ 10.3 * 9.5 ↑ 10.0 → 9.8 ↘
 beste Teiler 92.5 (2.) 110.6 (3.) 158.8 (7.)
 Trefferlage 0.55 mm rechts, 0.30 mm hoch
 Streuwert 2.08, horizontal: 1.83, vertikal: 2.30

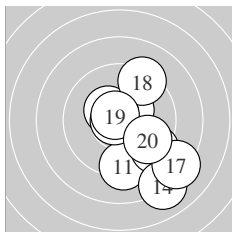

Serie 2:
 9.2 ↓ 10.4 * 9.2 ↘ 8.1 ↘ 10.4 *
 10.8 * 8.3 ↘ 9.3 ↑ 10.7 * 9.7 ↘
 beste Teiler 49.2 (16.) 62.2 (19.) 135.0 (12.)
 Trefferlage 1.65 mm rechts, 1.30 mm tief
 Streuwert 2.60, horizontal: 2.13, vertikal: 2.99

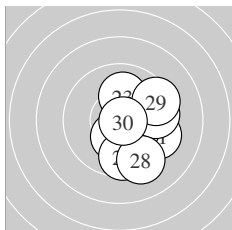

Serie 3:
 9.4 ↘ 10.1 ↘ 10.1 ↑ 10.3 * 10.3 *
 9.6 ↓ 9.6 → 9.3 ↘ 9.4 → 10.8 *
 beste Teiler 33.2 (30.) 159.7 (25.) 171.3 (24.)
 Trefferlage 1.51 mm rechts, 0.82 mm tief
 Streuwert 1.74, horizontal: 1.48, vertikal: 1.96

Unterschrift des Schützen

Ergebnis: **305.6** (292)
 Serien: 100.7 104.4 100.5
 Zähler: 22 8 0 0 0 0 0 0 0 0
 Innenzehner: 16
 weiteste: 420 (30), 374 (6), 328 (2)
 beste Teiler 35.3 (13.) 40.0 (19.) 71.0 (5.)
 Trefferlage 0.02 mm rechts, 0.27 mm tief
 Streuwert 1.52, horizontal: 1.65, vertikal: 1.39

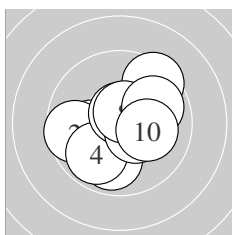
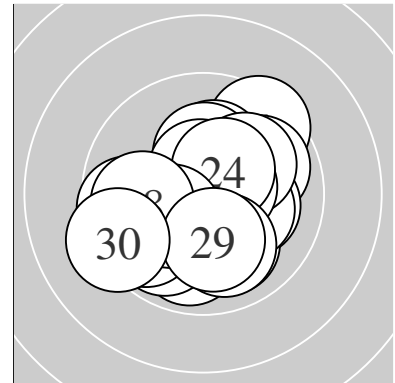

Serie 1:
 10.1 ← 9.6 ← 9.9 ↓ 9.9 ↙ 10.7 *
 9.5 ↗ 10.4 * 10.6 * 9.9 ↘ 10.1 →
 beste Teiler 71.0 (5.) 87.8 (8.) 132.0 (7.)
 Trefferlage 0.07 mm rechts, 0.15 mm tief
 Streuwert 1.79, horizontal: 1.96, vertikal: 1.61

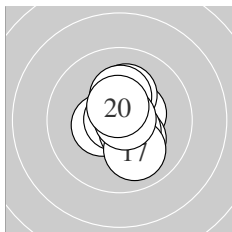

Serie 2:
 10.4 * 10.5 * 10.8 * 10.2 * 10.3 *
 10.5 * 10.0 ↓ 10.3 * 10.8 * 10.6 *
 beste Teiler 35.3 (13.) 40.0 (19.) 99.8 (20.)
 Trefferlage 0.32 mm rechts, 0.05 mm hoch
 Streuwert 1.05, horizontal: 0.77, vertikal: 1.27

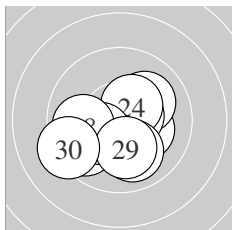

Serie 3:
 10.2 * 10.1 ↗ 10.5 * 10.4 * 10.0 ↓
 9.7 ↙ 10.3 * 9.9 ← 10.1 ↓ 9.3 ←
 beste Teiler 101.8 (23.) 136.3 (24.) 169.7 (27.)
 Trefferlage 0.34 mm links, 0.73 mm tief
 Streuwert 1.69, horizontal: 2.01, vertikal: 1.29

Unterschrift des Schützen

Ergebnis: **309.5** (294)
 Serien: 103.0 103.5 103.0
 Zähler: 24 6 0 0 0 0 0 0 0 0
 Innenzehner: 21
 weiteste: 326 (19), 300 (8), 281 (27)
 beste Teiler 13.9 (15.) 31.0 (9.) 68.5 (29.)
 Trefferlage 0.57 mm links, 0.06 mm tief
 Streuwert 1.22, horizontal: 1.20, vertikal: 1.23

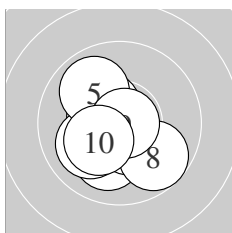
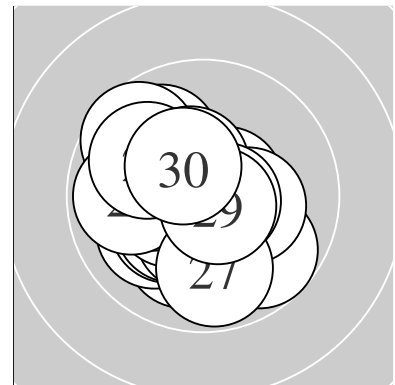

Serie 1:
 10.1 ↙ 10.5 * 10.4 * 10.0 ↙ 9.9 ↗
 10.7 * 10.5 * 9.8 ↘ 10.8 * 10.3 *
 beste Teiler 31.0 (9.) 70.0 (6.) 122.4 (2.)
 Trefferlage 0.47 mm links, 0.48 mm tief
 Streuwert 1.29, horizontal: 1.23, vertikal: 1.35

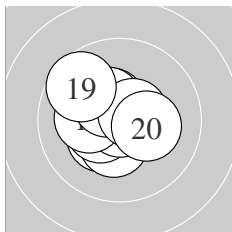

Serie 2:
 10.3 * 10.4 * 10.5 * 10.4 * 10.9 *
 10.2 * 10.4 * 10.6 * 9.6 ↗ 10.2 *
 beste Teiler 13.9 (15.) 94.8 (18.) 122.9 (13.)
 Trefferlage 0.58 mm links, 0.14 mm hoch
 Streuwert 1.17, horizontal: 1.25, vertikal: 1.09

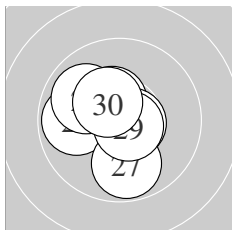

Serie 3:
 10.4 * 10.6 * 10.6 * 10.7 * 10.1 ↗
 9.8 ← 9.8 ↓ 9.9 ↗ 10.7 * 10.4 *
 beste Teiler 68.5 (29.) 74.6 (24.) 77.3 (23.)
 Trefferlage 0.65 mm links, 0.14 mm hoch
 Streuwert 1.25, horizontal: 1.25, vertikal: 1.26

Unterschrift des Schützen

Ergebnis: **284.3** (269)
 Serien: 93.0 96.1 95.2
 Zähler: 8 16 5 0 0 1 0 0 0 0
 Innenzehner: 6
 weiteste: 1287 (24), 649 (8), 607 (2)
 beste Teiler 47.8 (19.) 50.9 (23.) 136.8 (28.)
 Trefferlage 1.98 mm links, 0.27 mm tief
 Streuwert 2.80, horizontal: 2.63, vertikal: 2.95

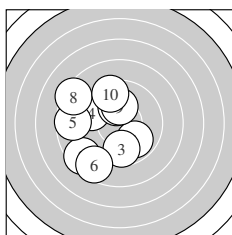
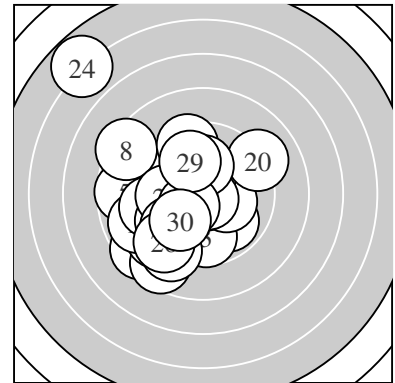

Serie 1:
 9.9 ↘ 8.5 ↙ 9.7 ↓ 9.5 ↖ 8.7 ←
 8.6 ↙ 10.2 * 8.4 ↖ 10.1 ↑ 9.4 ↑
 beste Teiler 197.8 (7.) 203.0 (9.) 270.2 (1.)
 Trefferlage 2.18 mm links, 0.18 mm tief
 Streuwert 2.90, horizontal: 2.65, vertikal: 3.13

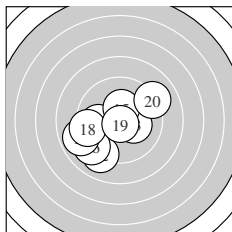

Serie 2:
 9.9 ← 9.1 ↙ 10.2 * 9.3 ← 10.4 *
 9.1 ↙ 8.9 ← 9.3 ← 10.8 * 9.1 ↗
 beste Teiler 47.8 (19.) 150.6 (15.) 179.9 (13.)
 Trefferlage 1.48 mm links, 0.90 mm tief
 Streuwert 2.45, horizontal: 2.85, vertikal: 1.97

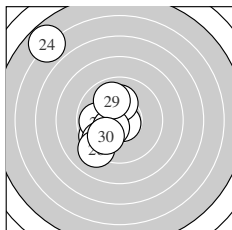

Serie 3:
 9.6 ↙ 9.9 ← 10.8 * 5.8 ↖ 9.6 ↙
 9.2 ↙ 10.1 ↑ 10.4 * 9.9 ↑ 9.9 ↙
 beste Teiler 50.9 (23.) 136.8 (28.) 206.0 (27.)
 Trefferlage 2.28 mm links, 0.25 mm hoch
 Streuwert 3.19, horizontal: 2.58, vertikal: 3.70

Unterschrift des Schützen

Ergebnis: **296.3** (287)
 Serien: 101.2 97.8 97.3
 Zähler: 18 11 1 0 0 0 0 0 0 0
 Innenzehner: 10
 weiteste: 564 (24), 475 (4), 467 (23)
 beste Teiler 81.0 (7.) 92.9 (8.) 113.7 (1.)
 Trefferlage 0.79 mm rechts, 0.70 mm hoch
 Streuwert 2.04, horizontal: 2.26, vertikal: 1.78

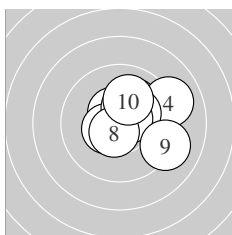
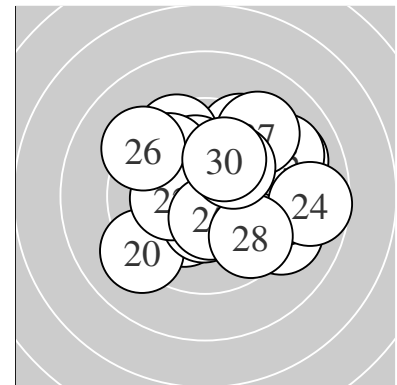

Serie 1:
 10.5 * 10.5 * 10.1 ↗ 9.1 → 10.3 *
 10.3 * 10.6 * 10.6 * 9.1 ↘ 10.1 ↗
 beste Teiler 81.0 (7.) 92.9 (8.) 113.7 (1.)
 Trefferlage 1.10 mm rechts, 0.60 mm hoch
 Streuwert 1.61, horizontal: 1.85, vertikal: 1.32

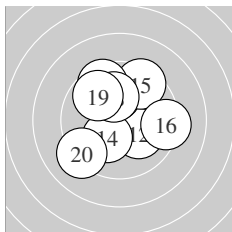

Serie 2:
 10.0 ↗ 10.1 ↘ 10.1 ↑ 10.2 * 9.5 ↗
 9.3 → 9.5 ↘ 10.1 ↑ 9.8 ↘ 9.2 ↙
 beste Teiler 190.6 (14.) 208.0 (12.) 213.4 (18.)
 Trefferlage 0.01 mm rechts, 0.88 mm hoch
 Streuwert 2.21, horizontal: 2.22, vertikal: 2.20

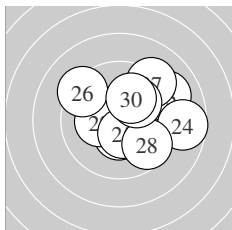

Serie 3:
 10.4 * 10.2 * 9.1 ↗ 8.7 → 10.5 *
 9.3 ↘ 9.2 ↗ 9.7 ↘ 10.1 ↗ 10.1 ↗
 beste Teiler 120.5 (25.) 132.1 (21.) 178.4 (22.)
 Trefferlage 1.27 mm rechts, 0.63 mm hoch
 Streuwert 2.32, horizontal: 2.67, vertikal: 1.90

Unterschrift des Schützen

Ergebnis: **301.8** (293)
 Serien: 101.9 98.0 101.9
 Zähler: 24 5 1 0 0 0 0 0 0 0
 Innenzehner: 16
 weiteste: 711 (19), 481 (17), 441 (18)
 beste Teiler 40.0 (2.) 62.6 (27.) 73.3 (20.)
 Trefferlage 0.37 mm links, 1.25 mm hoch
 Streuwert 1.61, horizontal: 1.76, vertikal: 1.44

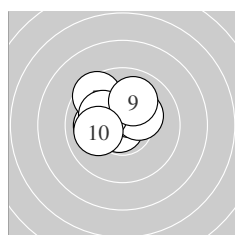
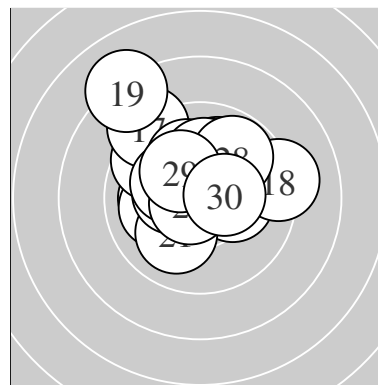

Serie 1:
 10.3 * 10.8 * 10.3 * 10.4 * 10.1 ←
 10.3 * 9.5 ↘ 10.2 * 10.0 ↗ 10.0 ←
 beste Teiler 40.0 (2.) 126.5 (4.) 153.6 (3.)
 Trefferlage 0.56 mm links, 0.97 mm hoch
 Streuwert 1.28, horizontal: 1.49, vertikal: 1.02

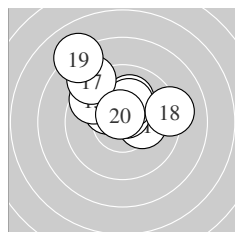

Serie 2:
 10.2 * 10.6 * 10.3 * 10.1 ↗ 9.6 ↘
 10.2 * 9.0 ↘ 9.2 → 8.1 ↘ 10.7 *
 beste Teiler 73.3 (20.) 82.2 (12.) 175.1 (13.)
 Trefferlage 0.34 mm links, 1.90 mm hoch
 Streuwert 2.14, horizontal: 2.46, vertikal: 1.77

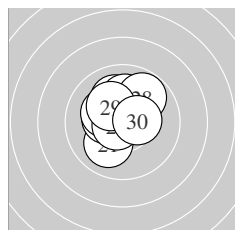

Serie 3:
 10.0 ↘ 10.0 ↗ 10.1 ↘ 10.1 ↑ 10.4 *
 10.2 * 10.7 * 9.8 ↗ 10.2 * 10.4 *
 beste Teiler 62.6 (27.) 135.0 (30.) 150.2 (25.)
 Trefferlage 0.21 mm links, 0.88 mm hoch
 Streuwert 1.31, horizontal: 1.27, vertikal: 1.34

Unterschrift des Schützen

Meyton Elektronik

Ergebnis: **307.4** (293)
 Serien: 104.4 101.0 102.0
 Zähler: 24 5 1 0 0 0 0 0 0 0
 Innenzehner: 19
 weiteste: 669 (15), 406 (18), 326 (27)
 beste Teiler 20.2 (6.) 23.0 (9.) 41.1 (14.)
 Trefferlage 0.17 mm rechts, 0.03 mm tief
 Streuwert 1.58, horizontal: 1.88, vertikal: 1.20

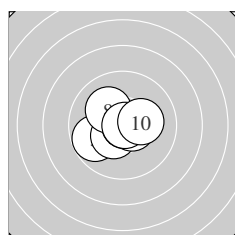
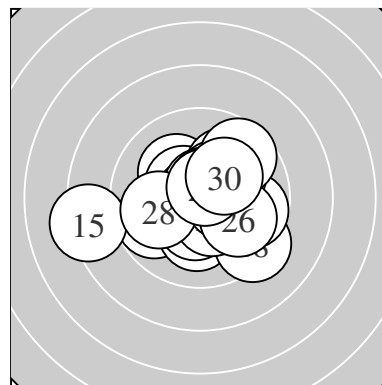

Serie 1:
 10.3 * 10.7 * 9.8 ↙ 10.5 * 10.4 *
 10.9 * 10.6 * 10.1 ↘ 10.9 * 10.2 *
 beste Teiler 20.2 (6.) 23.0 (9.) 66.4 (2.)
 Trefferlage 0.29 mm links, 0.06 mm tief
 Streuwert 1.10, horizontal: 1.30, vertikal: 0.86

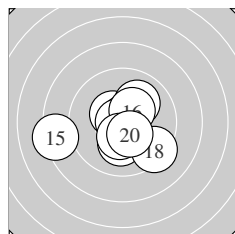

Serie 2:
 10.5 * 10.0 ↗ 10.8 * 10.8 * 8.3 ←
 10.4 * 10.1 ↓ 9.3 ↘ 10.4 * 10.4 *
 beste Teiler 41.1 (14.) 42.1 (13.) 125.0 (11.)
 Trefferlage 0.21 mm links, 0.45 mm tief
 Streuwert 2.06, horizontal: 2.50, vertikal: 1.49

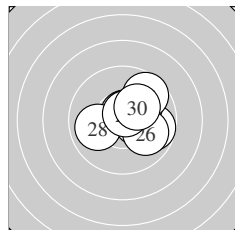

Serie 3:
 9.8 → 10.7 * 10.4 * 10.1 ↗ 10.6 *
 9.9 ↘ 9.6 ↗ 10.0 ← 10.7 * 10.2 *
 beste Teiler 66.0 (22.) 68.4 (29.) 81.8 (25.)
 Trefferlage 1.02 mm rechts, 0.42 mm hoch
 Streuwert 1.33, horizontal: 1.51, vertikal: 1.12

Unterschrift des Schützen

Meyton Elektronik

Ergebnis: **308.8** (297)
 Serien: 102.3 103.0 103.5
 Zähler: 27 3 0 0 0 0 0 0 0 0
 Innenzehner: 18
 weiteste: 309 (11), 275 (6), 254 (4)
 beste Teiler 19.4 (5.) 35.1 (19.) 47.2 (13.)
 Trefferlage 0.23 mm rechts, 0.58 mm tief
 Streuwert 1.21, horizontal: 1.24, vertikal: 1.18

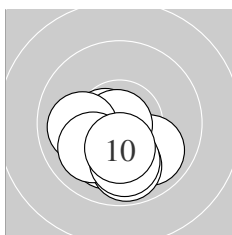
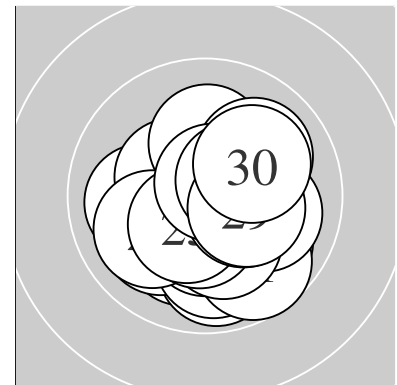

Serie 1:
 10.6 * 10.6 * 10.1 ↙ 9.9 ↘ 10.9 *
 9.9 ↓ 10.0 ← 10.0 ↗ 10.0 ↓ 10.3 *
 beste Teiler 19.4 (5.) 84.8 (1.) 92.0 (2.)
 Trefferlage 0.39 mm links, 1.29 mm tief
 Streuwert 1.09, horizontal: 1.19, vertikal: 0.98

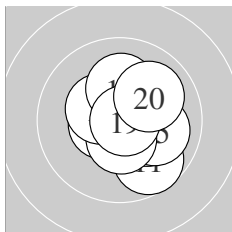

Serie 2:
 9.7 ↘ 10.2 * 10.8 * 10.5 * 10.0 →
 10.5 * 10.4 * 10.1 ↑ 10.8 * 10.0 ↗
 beste Teiler 35.1 (19.) 47.2 (13.) 105.0 (14.)
 Trefferlage 0.64 mm rechts, 0.10 mm tief
 Streuwert 1.27, horizontal: 1.23, vertikal: 1.30

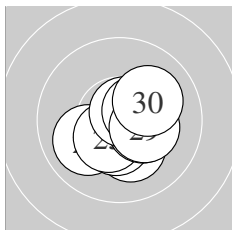

Serie 3:
 10.7 * 10.0 ↙ 10.2 * 10.4 * 10.4 *
 10.3 * 10.7 * 10.4 * 10.3 * 10.1 ↗
 beste Teiler 59.6 (27.) 61.5 (21.) 127.0 (28.)
 Trefferlage 0.44 mm rechts, 0.35 mm tief
 Streuwert 1.09, horizontal: 1.18, vertikal: 0.99

Unterschrift des Schützen

Ergebnis: **306.1** (293)
 Serien: 101.1 102.9 102.1
 Zähler: 23 7 0 0 0 0 0 0 0 0
 Innenzehner: 19
 weiteste: 434 (1), 367 (8), 343 (6)
 beste Teiler 41.6 (10.) 51.9 (25.) 61.0 (2.)
 Trefferlage 0.26 mm rechts, 0.34 mm hoch
 Streuwert 1.50, horizontal: 1.52, vertikal: 1.49

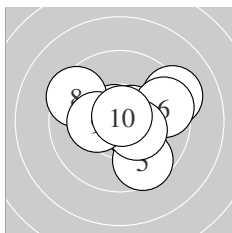
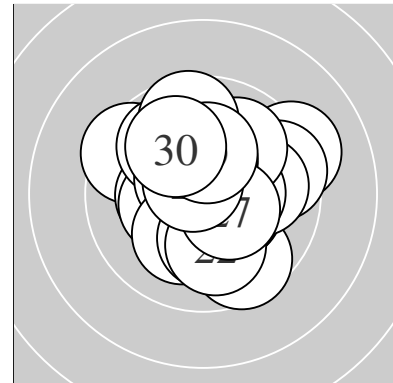

Serie 1:
 9.2 ↗ 10.7 * 10.4 * 10.6 * 9.6 ↘
 9.6 ↗ 10.4 * 9.5 ↖ 10.3 * 10.8 *
 beste Teiler 41.6 (10.) 61.0 (2.) 97.0 (4.)
 Trefferlage 0.71 mm rechts, 0.17 mm hoch
 Streuwert 1.80, horizontal: 2.13, vertikal: 1.38

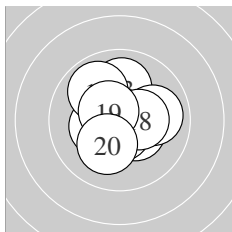

Serie 2:
 10.6 * 10.3 * 10.0 ↑ 10.4 * 10.0 →
 9.9 ↘ 10.6 * 10.4 * 10.5 * 10.2 *
 beste Teiler 79.5 (17.) 89.5 (11.) 105.8 (19.)
 Trefferlage 0.04 mm links, 0.16 mm hoch
 Streuwert 1.33, horizontal: 1.36, vertikal: 1.29

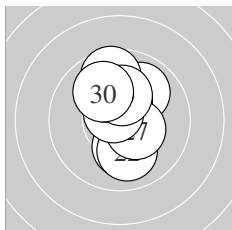

Serie 3:
 10.2 * 10.0 ↓ 9.9 ↗ 9.6 ↑ 10.7 *
 10.4 * 10.4 * 10.7 * 10.2 * 10.0 ↘
 beste Teiler 51.9 (25.) 71.8 (28.) 136.1 (27.)
 Trefferlage 0.13 mm rechts, 0.68 mm hoch
 Streuwert 1.41, horizontal: 0.82, vertikal: 1.83

Unterschrift des Schützen

Ergebnis: **304.6** (291)
 Serien: 101.4 102.0 101.2
 Zähler: 21 9 0 0 0 0 0 0 0 0
 Innenzehner: 16
 weiteste: 481 (5), 411 (25), 384 (10)
 beste Teiler 56.7 (16.) 66.0 (3.) 73.5 (8.)
 Trefferlage 0.52 mm links, 0.40 mm hoch
 Streuwert 1.58, horizontal: 1.75, vertikal: 1.38

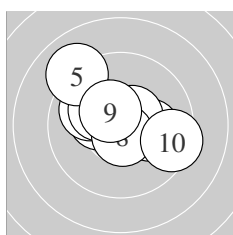
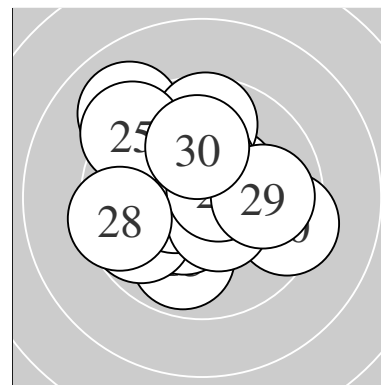

Serie 1:
 10.3 * 10.0 ↖ 10.7 * 10.2 * 9.0 ↖
 10.1 → 10.5 * 10.7 * 10.5 * 9.4 →
 beste Teiler 66.0 (3.) 73.5 (8.) 102.8 (7.)
 Trefferlage 0.17 mm links, 0.57 mm hoch
 Streuwert 1.74, horizontal: 2.07, vertikal: 1.33

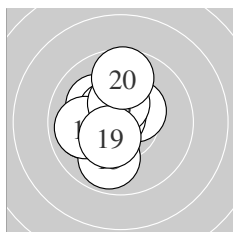

Serie 2:
 10.1 ↖ 10.0 ← 10.4 * 10.5 * 9.9 ↓
 10.7 * 9.9 ← 10.4 * 10.4 * 9.7 ↑
 beste Teiler 56.7 (16.) 109.4 (14.) 132.4 (19.)
 Trefferlage 0.85 mm links, 0.31 mm hoch
 Streuwert 1.36, horizontal: 1.13, vertikal: 1.56

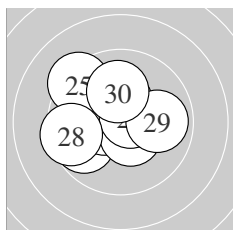

Serie 3:
 10.6 * 9.8 ↙ 10.5 * 10.4 * 9.3 ↖
 10.5 * 10.6 * 9.5 ← 9.9 → 10.1 ↑
 beste Teiler 79.6 (27.) 99.7 (21.) 116.8 (23.)
 Trefferlage 0.54 mm links, 0.32 mm hoch
 Streuwert 1.72, horizontal: 2.00, vertikal: 1.39

Unterschrift des Schützen

Meyton Elektronik

Ergebnis: **284.1** (270)
 Serien: 97.8 95.5 90.8
 Zähler: 7 16 7 0 0 0 0 0 0 0
 Innenzehner: 6
 weiteste: 627 (17), 625 (26), 622 (27)
 beste Teiler 111.6 (12.) 118.2 (22.) 127.1 (2.)
 Trefferlage 2.36 mm links, 0.54 mm hoch
 Streuwert 2.31, horizontal: 2.42, vertikal: 2.20

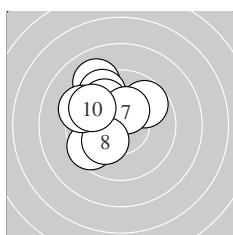
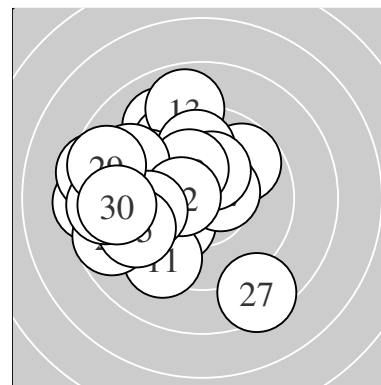

Serie 1:
 9.1 ↘ 10.4 * 9.5 ↘ 9.7 ↗ 9.9 ↘
 9.6 ↙ 10.4 * 10.1 ↙ 9.4 ↖ 9.7 ↖
 beste Teiler 127.1 (2.) 149.9 (7.) 207.1 (8.)
 Trefferlage 1.46 mm links, 1.27 mm hoch
 Streuwert 1.80, horizontal: 1.73, vertikal: 1.87

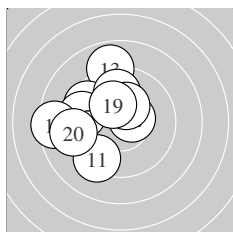

Serie 2:
 9.3 ↙ 10.5 * 8.9 ↑ 9.5 ↖ 9.5 ←
 9.8 ↑ 8.4 ← 10.3 * 10.2 * 9.1 ←
 beste Teiler 111.6 (12.) 162.8 (18.) 181.3 (19.)
 Trefferlage 2.02 mm links, 0.90 mm hoch
 Streuwert 2.31, horizontal: 2.35, vertikal: 2.27

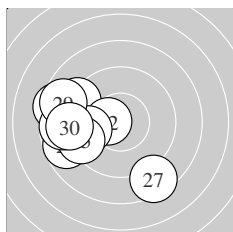

Serie 3:
 9.1 ↖ 10.5 * 9.7 ← 8.7 ← 9.3 ←
 8.5 ← 8.5 ↘ 8.8 ← 8.7 ↖ 9.0 ←
 beste Teiler 118.2 (22.) 314.8 (23.) 411.2 (25.)
 Trefferlage 3.59 mm links, 0.54 mm tief
 Streuwert 2.50, horizontal: 2.76, vertikal: 2.21

Unterschrift des Schützen

Meyton Elektronik

Ergebnis: **308.8** (294)
 Serien: 103.9 102.0 102.9
 Zähler: 24 6 0 0 0 0 0 0 0 0
 Innenzehner: 20
 weiteste: 460 (29), 320 (14), 319 (26)
 beste Teiler 22.1 (4.) 36.0 (27.) 40.3 (28.)
 Trefferlage 0.42 mm rechts, 0.77 mm tief
 Streuwert 1.24, horizontal: 1.56, vertikal: 0.78

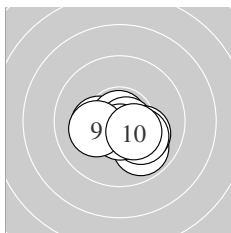
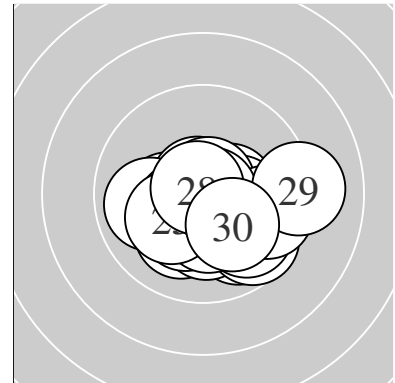

Serie 1:
 10.3 * 9.9 ↘ 10.7 * 10.9 * 10.7 *
 10.1 ↘ 10.1 ↘ 10.6 * 10.2 * 10.4 *
 beste Teiler 22.1 (4.) 60.0 (5.) 75.5 (3.)
 Trefferlage 0.32 mm rechts, 0.77 mm tief
 Streuwert 1.04, horizontal: 1.33, vertikal: 0.63

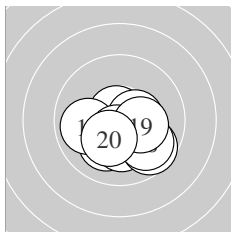

Serie 2:
 10.1 ↙ 10.7 * 10.2 * 9.7 ↘ 10.4 *
 9.9 ← 10.5 * 9.9 ↘ 10.3 * 10.3 *
 beste Teiler 57.7 (12.) 105.5 (17.) 126.2 (15.)
 Trefferlage 0.26 mm rechts, 1.03 mm tief
 Streuwert 1.29, horizontal: 1.57, vertikal: 0.94

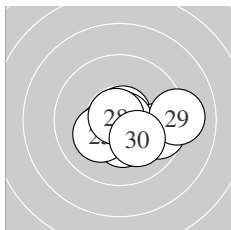

Serie 3:
 10.3 * 10.7 * 10.5 * 10.7 * 10.2 *
 9.7 → 10.8 * 10.8 * 9.1 → 10.1 ↘
 beste Teiler 36.0 (27.) 40.3 (28.) 55.4 (22.)
 Trefferlage 0.67 mm rechts, 0.51 mm tief
 Streuwert 1.43, horizontal: 1.88, vertikal: 0.75

Unterschrift des Schützen

Ergebnis: **309.3** (297)
 Serien: 103.8 102.6 102.9
 Zähler: 27 3 0 0 0 0 0 0 0 0
 Innenzehner: 21
 weiteste: 369 (23), 316 (12), 285 (16)
 beste Teiler 46.8 (26.) 64.0 (8.) 74.0 (18.)
 Trefferlage 0.25 mm rechts, 0.08 mm hoch
 Streuwert 1.26, horizontal: 1.23, vertikal: 1.29

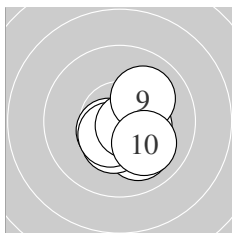
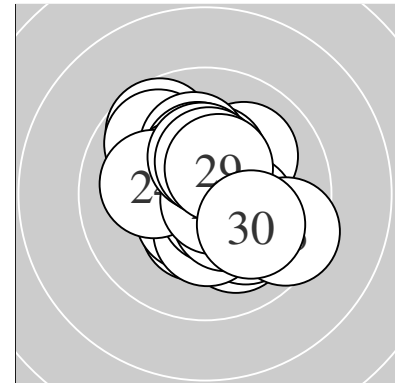

Serie 1:
 10.4 * 10.1 ↘ 10.4 * 10.6 * 10.6 *
 10.5 * 10.4 * 10.7 * 10.1 ↗ 10.0 ↘
 beste Teiler 64.0 (8.) 100.6 (4.) 100.6 (5.)
 Trefferlage 0.68 mm rechts, 0.63 mm tief
 Streuwert 0.95, horizontal: 0.95, vertikal: 0.94

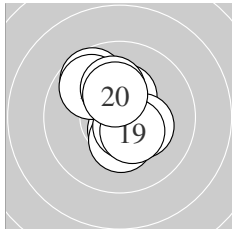

Serie 2:
 10.4 * 9.7 ↖ 10.6 * 10.3 * 10.3 *
 9.8 ↖ 10.1 ↑ 10.7 * 10.4 * 10.3 *
 beste Teiler 74.0 (18.) 86.0 (13.) 130.2 (19.)
 Trefferlage 0.13 mm links, 0.49 mm hoch
 Streuwert 1.34, horizontal: 1.10, vertikal: 1.55

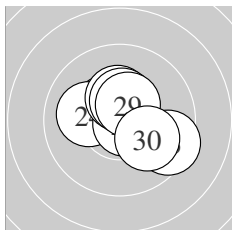

Serie 3:
 10.4 * 10.4 * 9.5 ↘ 10.1 ← 10.5 *
 10.8 * 10.3 * 10.4 * 10.5 * 10.0 ↘
 beste Teiler 46.8 (26.) 121.2 (29.) 122.5 (25.)
 Trefferlage 0.21 mm rechts, 0.39 mm hoch
 Streuwert 1.34, horizontal: 1.56, vertikal: 1.09

Unterschrift des Schützen

Ergebnis: **302.0** (291)
 Serien: 101.5 98.3 102.2
 Zähler: 21 9 0 0 0 0 0 0 0 0
 Innenzehner: 14
 weiteste: 498 (18), 410 (12), 384 (4)
 beste Teiler 94.2 (5.) 95.1 (10.) 110.4 (26.)
 Trefferlage 0.40 mm links, 0.59 mm tief
 Streuwert 1.67, horizontal: 1.80, vertikal: 1.53

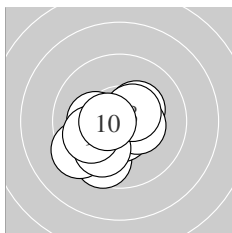
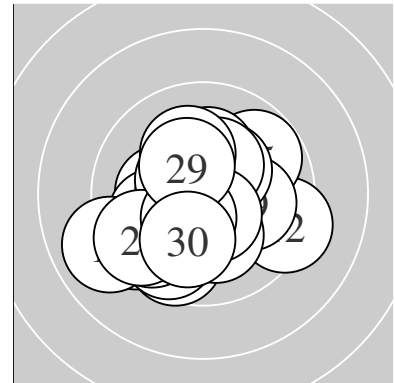

Serie 1:
 10.2 * 10.3 * 9.6 ↙ 9.4 ↙ 10.6 *
 10.4 * 9.9 ↙ 10.5 * 10.0 ↙ 10.6 *
 beste Teiler 94.2 (5.) 95.1 (10.) 119.8 (8.)
 Trefferlage 0.70 mm links, 0.80 mm tief
 Streuwert 1.45, horizontal: 1.58, vertikal: 1.30

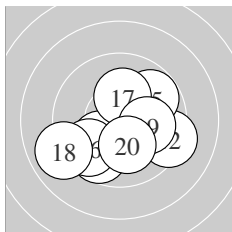

Serie 2:
 9.7 ↙ 9.3 → 10.3 * 10.1 ↙ 9.8 ↗
 9.7 ↙ 10.2 * 9.0 ↙ 10.1 → 10.1 ↓
 beste Teiler 171.7 (13.) 184.4 (17.) 202.1 (20.)
 Trefferlage 0.06 mm rechts, 0.79 mm tief
 Streuwert 2.16, horizontal: 2.51, vertikal: 1.74

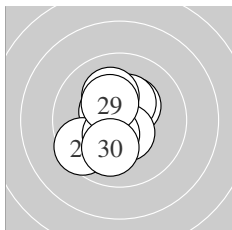

Serie 3:
 10.5 * 10.4 * 10.4 * 10.1 ↙ 9.5 ↙
 10.5 * 10.1 ↘ 10.4 * 10.3 * 10.0 ↓
 beste Teiler 110.4 (26.) 115.6 (21.) 131.0 (28.)
 Trefferlage 0.57 mm links, 0.19 mm tief
 Streuwert 1.38, horizontal: 1.10, vertikal: 1.61

Unterschrift des Schützen

Ergebnis: **289.5** (277)
 Serien: 98.4 93.6 97.5
 Zähler: 11 15 4 0 0 0 0 0 0 0
 Innenzehner: 8
 weiteste: 693 (14), 687 (11), 590 (19)
 beste Teiler 31.8 (25.) 52.0 (22.) 72.6 (16.)
 Trefferlage 1.57 mm rechts, 1.16 mm tief
 Streuwert 2.26, horizontal: 2.72, vertikal: 1.68

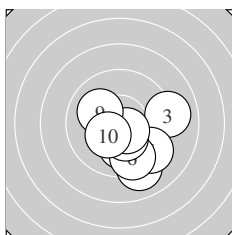
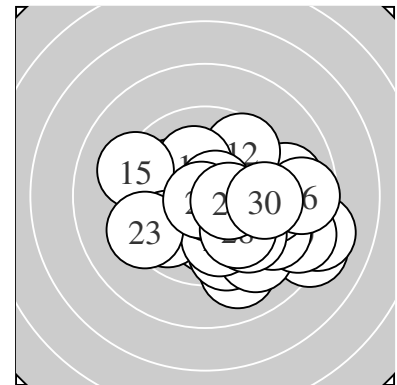

Serie 1:
 9.1 ↘ 10.1 ↘ 9.0 → 10.1 ↓ 9.3 ↘
 9.5 ↘ 10.3 * 10.6 * 10.1 ↖ 10.3 *
 beste Teiler 100.4 (8.) 155.8 (7.) 161.2 (10.)
 Trefferlage 1.01 mm rechts, 1.58 mm tief
 Streuwert 1.81, horizontal: 1.91, vertikal: 1.71

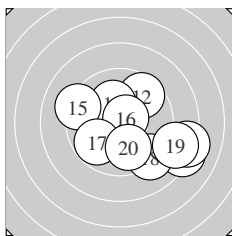

Serie 2:
 8.2 ↘ 9.6 ↗ 10.2 * 8.2 → 9.2 ↖
 10.7 * 9.8 ↙ 9.2 ↘ 8.6 → 9.9 ↓
 beste Teiler 72.6 (16.) 196.0 (13.) 261.2 (20.)
 Trefferlage 1.78 mm rechts, 0.89 mm tief
 Streuwert 2.99, horizontal: 3.58, vertikal: 2.24

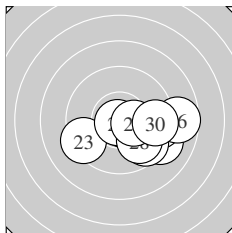

Serie 3:
 9.2 ↘ 10.7 * 9.3 ↙ 9.4 → 10.8 *
 8.7 → 9.6 ↘ 9.8 ↘ 10.4 * 9.6 →
 beste Teiler 31.8 (25.) 52.0 (22.) 142.2 (29.)
 Trefferlage 1.94 mm rechts, 1.01 mm tief
 Streuwert 1.97, horizontal: 2.62, vertikal: 0.94

Unterschrift des Schützen

Ergebnis: **312.4** (298)
 Serien: 104.5 102.9 105.0
 Zähler: 28 2 0 0 0 0 0 0 0 0
 Innenzehner: 25
 weiteste: 358 (17), 299 (29), 207 (7)
 beste Teiler 31.0 (30.) 45.1 (3.) 54.0 (5.)
 Trefferlage 0.08 mm links, 0.12 mm hoch
 Streuwert 1.10, horizontal: 1.28, vertikal: 0.88

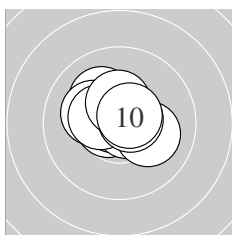
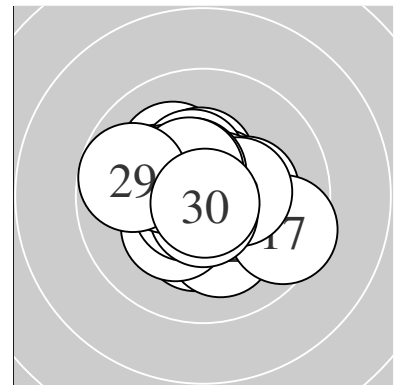

Serie 1:
 10.1 ↖ 10.6 * 10.8 * 10.2 * 10.7 *
 10.4 * 10.1 ↗ 10.6 * 10.4 * 10.6 *
 beste Teiler 45.1 (3.) 54.0 (5.) 78.7 (2.)
 Trefferlage 0.17 mm links, 0.41 mm hoch
 Streuwert 0.96, horizontal: 1.16, vertikal: 0.71

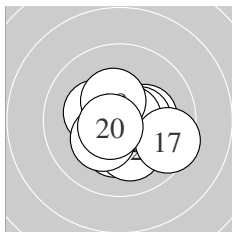

Serie 2:
 10.3 * 10.1 ↓ 10.3 * 10.4 * 10.3 *
 10.7 * 9.5 ↘ 10.4 * 10.3 * 10.6 *
 beste Teiler 64.5 (16.) 78.2 (20.) 130.1 (14.)
 Trefferlage 0.35 mm rechts, 0.44 mm tief
 Streuwert 1.30, horizontal: 1.48, vertikal: 1.08

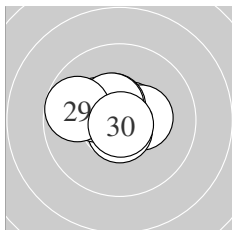

Serie 3:
 10.7 * 10.4 * 10.7 * 10.7 * 10.6 *
 10.5 * 10.3 * 10.5 * 9.8 ← 10.8 *
 beste Teiler 31.0 (30.) 69.0 (23.) 72.4 (24.)
 Trefferlage 0.42 mm links, 0.42 mm hoch
 Streuwert 0.91, horizontal: 1.17, vertikal: 0.55

Unterschrift des Schützen

Ergebnis: **306.0** (290)
 Serien: 101.3 102.4 102.3
 Zähler: 20 10 0 0 0 0 0 0 0 0
 Innenzehner: 18
 weiteste: 443 (10), 403 (13), 371 (15)
 beste Teiler 25.5 (17.) 48.4 (16.) 48.6 (19.)
 Trefferlage 0.53 mm links, 1.00 mm tief
 Streuwert 1.34, horizontal: 1.30, vertikal: 1.39

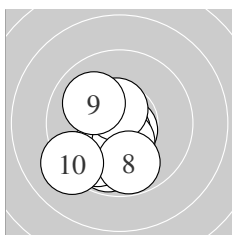
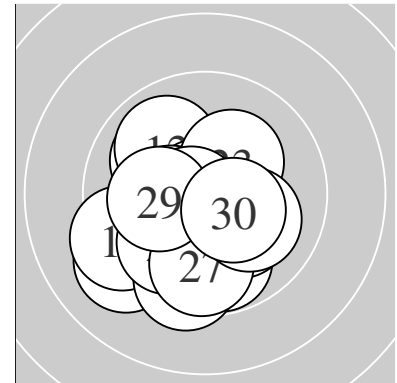

Serie 1:
 10.4 * 10.7 * 9.8 ↓ 10.7 * 9.8 ↙
 10.4 * 10.5 * 9.8 ↓ 10.0 ↖ 9.2 ↙
 beste Teiler 56.0 (4.) 67.8 (2.) 101.4 (7.)
 Trefferlage 0.67 mm links, 1.19 mm tief
 Streuwert 1.41, horizontal: 1.26, vertikal: 1.54

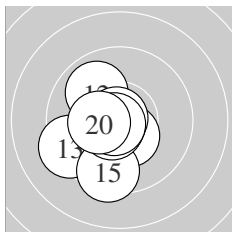

Serie 2:
 9.8 ↙ 9.9 ↖ 9.3 ↙ 10.4 * 9.5 ↓
 10.8 * 10.9 * 10.6 * 10.8 * 10.4 *
 beste Teiler 25.5 (17.) 48.4 (16.) 48.6 (19.)
 Trefferlage 1.03 mm links, 0.79 mm tief
 Streuwert 1.35, horizontal: 1.17, vertikal: 1.51

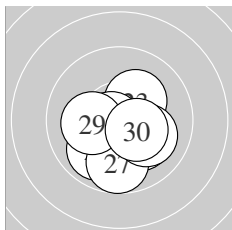

Serie 3:
 10.2 * 9.9 ↙ 10.2 * 10.2 * 10.6 *
 10.7 * 9.8 ↓ 10.1 ↖ 10.2 * 10.4 *
 beste Teiler 62.6 (26.) 85.4 (25.) 140.6 (30.)
 Trefferlage 0.11 mm rechts, 1.01 mm tief
 Streuwert 1.26, horizontal: 1.30, vertikal: 1.21

Unterschrift des Schützen

Ergebnis: **305.0** (292)
 Serien: 102.8 102.3 99.9
 Zähler: 22 8 0 0 0 0 0 0 0 0
 Innenzehner: 19
 weiteste: 490 (28), 455 (10), 399 (11)
 beste Teiler 14.3 (5.) 49.9 (26.) 58.1 (14.)
 Trefferlage 0.46 mm rechts, 0.47 mm tief
 Streuwert 1.62, horizontal: 1.93, vertikal: 1.22

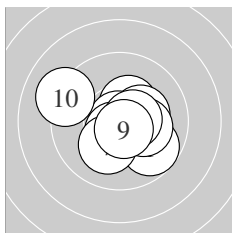
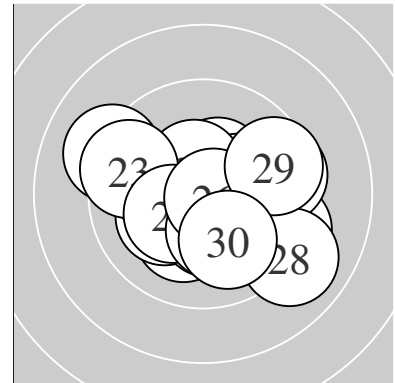

Serie 1:
 9.8 ↘ 10.4 * 10.3 * 10.2 * 10.9 *
 10.6 * 10.2 * 10.6 * 10.7 * 9.1 ↖
 beste Teiler 14.3 (5.) 68.0 (9.) 87.7 (6.)
 Trefferlage 0.21 mm rechts, 0.17 mm tief
 Streuwert 1.56, horizontal: 1.84, vertikal: 1.20

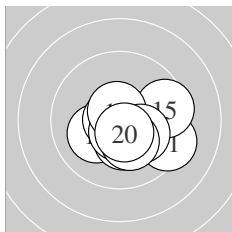

Serie 2:
 9.4 ↘ 10.1 ↖ 10.3 * 10.7 * 9.5 →
 10.6 * 10.7 * 10.2 * 10.2 * 10.6 *
 beste Teiler 58.1 (14.) 73.0 (17.) 87.8 (16.)
 Trefferlage 0.74 mm rechts, 0.70 mm tief
 Streuwert 1.38, horizontal: 1.72, vertikal: 0.92

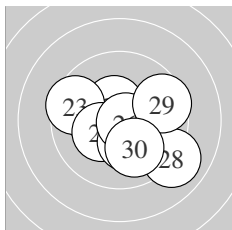

Serie 3:
 10.1 ↖ 10.5 * 9.5 ↖ 10.3 * 10.3 *
 10.8 * 9.8 ↘ 9.0 ↘ 9.6 → 10.0 ↘
 beste Teiler 49.9 (26.) 122.0 (22.) 166.1 (24.)
 Trefferlage 0.44 mm rechts, 0.54 mm tief
 Streuwert 1.98, horizontal: 2.35, vertikal: 1.53

Unterschrift des Schützen

Ergebnis: **295.8** (281)
 Serien: 100.4 98.7 96.7
 Zähler: 13 15 2 0 0 0 0 0 0 0
 Innenzehner: 7
 weiteste: 593 (28), 590 (25), 442 (12)
 beste Teiler 50.3 (14.) 55.2 (30.) 92.2 (13.)
 Trefferlage 0.28 mm links, 1.00 mm hoch
 Streuwert 2.04, horizontal: 2.21, vertikal: 1.87

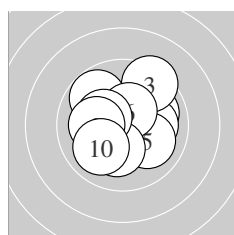
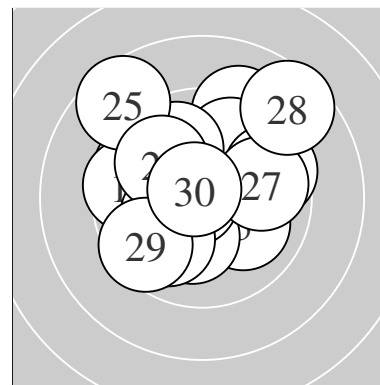

Serie 1:
 10.0 → 10.1 → 9.4 ↗ 9.8 ↘ 10.0 ↘
 10.5 * 10.2 * 10.3 * 10.1 ← 10.0 ↙
 beste Teiler 124.4 (6.) 161.9 (8.) 191.3 (7.)
 Trefferlage 0.13 mm rechts, 0.33 mm hoch
 Streuwert 1.78, horizontal: 1.89, vertikal: 1.66

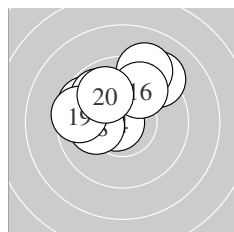

Serie 2:
 9.2 ↗ 9.2 ↗ 10.6 * 10.8 * 9.7 ↘
 9.8 ↗ 9.8 ↘ 10.1 ← 9.6 ← 9.9 ↘
 beste Teiler 50.3 (14.) 92.2 (13.) 212.2 (18.)
 Trefferlage 0.69 mm links, 1.66 mm hoch
 Streuwert 1.79, horizontal: 2.08, vertikal: 1.45

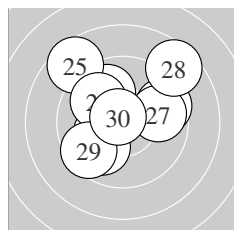

Serie 3:
 10.2 * 9.9 ↙ 9.9 ↘ 9.5 → 8.6 ↘
 9.9 ↘ 9.8 → 8.6 ↗ 9.6 ↙ 10.7 *
 beste Teiler 55.2 (30.) 182.9 (21.) 256.4 (22.)
 Trefferlage 0.30 mm links, 1.02 mm hoch
 Streuwert 2.53, horizontal: 2.72, vertikal: 2.33

Unterschrift des Schützen

Meyton Elektronik

Ergebnis: **289.9** (273)
 Serien: 97.9 99.0 93.0
 Zähler: 9 17 2 2 0 0 0 0 0 0
 Innenzehner: 6
 weiteste: 780 (29), 778 (30), 603 (15)
 beste Teiler 39.0 (20.) 78.0 (1.) 109.8 (19.)
 Trefferlage 0.08 mm rechts, 0.27 mm tief
 Streuwert 2.63, horizontal: 3.21, vertikal: 1.88

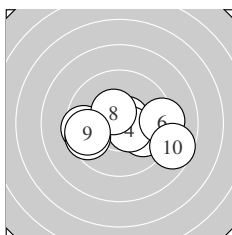
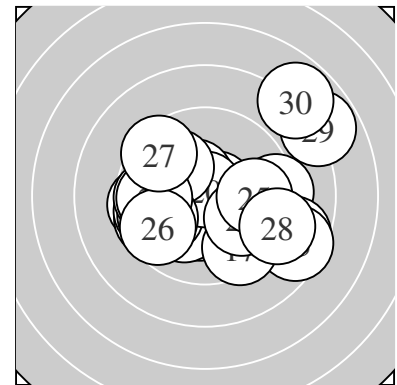

Serie 1:
 10.6 * 9.9 ↘ 9.7 ← 10.5 * 9.5 ←
 9.3 → 9.6 ← 10.5 * 9.6 ← 8.7 ↘
 beste Teiler 78.0 (1.) 115.2 (4.) 125.7 (8.)
 Trefferlage 0.01 mm links, 0.56 mm tief
 Streuwert 2.39, horizontal: 3.24, vertikal: 0.96

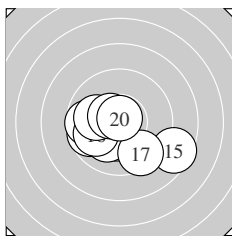

Serie 2:
 9.7 ← 10.3 * 10.1 ↙ 9.7 ← 8.5 ↘
 9.9 ← 9.5 ↘ 10.0 ← 10.5 * 10.8 *
 beste Teiler 39.0 (20.) 109.8 (19.) 161.9 (12.)
 Trefferlage 0.57 mm links, 1.00 mm tief
 Streuwert 2.07, horizontal: 2.61, vertikal: 1.32

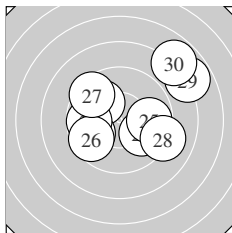

Serie 3:
 10.0 ↘ 9.8 ← 9.7 ← 9.9 ↘ 9.8 →
 9.6 ← 9.5 ↘ 9.1 ↘ 7.8 ↗ 7.8 ↗
 beste Teiler 242.5 (21.) 253.8 (24.) 293.0 (25.)
 Trefferlage 0.85 mm rechts, 0.74 mm hoch
 Streuwert 3.28, horizontal: 3.84, vertikal: 2.62

Unterschrift des Schützen

Ergebnis: **301.3** (286)
 Serien: 100.3 101.5 99.5
 Zähler: 17 12 1 0 0 0 0 0 0 0
 Innenzehner: 14
 weiteste: 545 (4), 469 (24), 468 (23)
 beste Teiler 42.2 (26.) 54.5 (20.) 70.2 (6.)
 Trefferlage 0.93 mm links, 0.85 mm hoch
 Streuwert 1.64, horizontal: 1.87, vertikal: 1.38

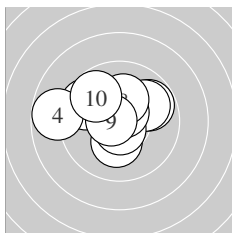
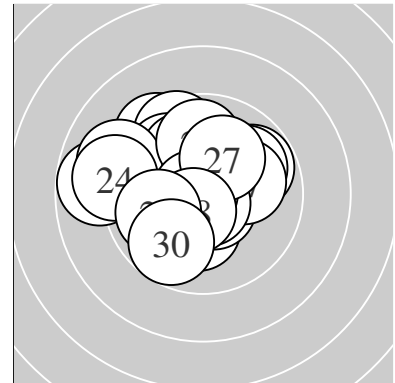

Serie 1:
 9.8 ↗ 9.9 ↗ 9.6 ↖ 8.8 ← 10.2 *
 10.7 * 10.6 * 10.2 * 10.7 * 9.8 ↘
 beste Teiler 70.2 (6.) 73.4 (9.) 84.6 (7.)
 Trefferlage 0.60 mm links, 0.72 mm hoch
 Streuwert 1.89, horizontal: 2.37, vertikal: 1.23

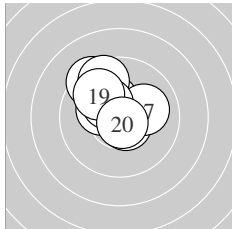

Serie 2:
 10.3 * 9.4 ↘ 10.3 * 10.3 * 10.6 *
 9.6 ↘ 10.1 → 10.3 * 9.9 ↘ 10.7 *
 beste Teiler 54.5 (20.) 86.6 (15.) 157.2 (18.)
 Trefferlage 0.67 mm links, 1.24 mm hoch
 Streuwert 1.31, horizontal: 1.33, vertikal: 1.29

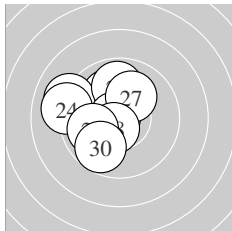

Serie 3:
 10.4 * 10.0 ↘ 9.1 ↖ 9.1 ← 9.9 ↑
 10.8 * 10.1 ↗ 10.5 * 9.9 ← 9.7 ↙
 beste Teiler 42.2 (26.) 102.5 (28.) 147.9 (21.)
 Trefferlage 1.51 mm links, 0.58 mm hoch
 Streuwert 1.73, horizontal: 1.81, vertikal: 1.64

Unterschrift des Schützen

Ergebnis: **309.5** (295)
 Serien: 103.1 103.8 102.6
 Zähler: 25 5 0 0 0 0 0 0 0 0
 Innenzehner: 22
 weiteste: 402 (22), 391 (3), 287 (17)
 beste Teiler 25.2 (2.) 45.1 (24.) 64.5 (19.)
 Trefferlage 0.38 mm rechts, 0.12 mm hoch
 Streuwert 1.28, horizontal: 1.36, vertikal: 1.20

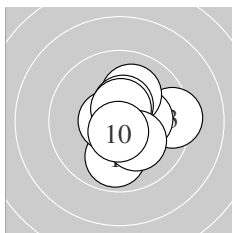
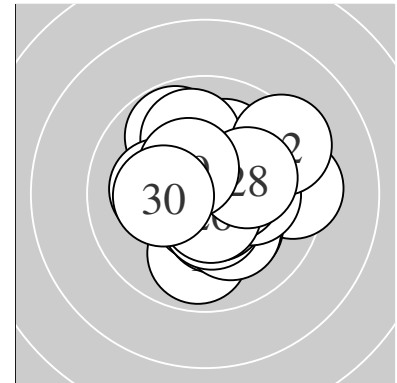

Serie 1:
 9.9 ↓ 10.9 * 9.4 → 10.6 * 10.3 *
 10.1 ↗ 10.5 * 10.6 * 10.2 * 10.6 *
 beste Teiler 25.2 (2.) 78.6 (10.) 83.0 (4.)
 Trefferlage 0.68 mm rechts, 0.06 mm tief
 Streuwert 1.34, horizontal: 1.36, vertikal: 1.33

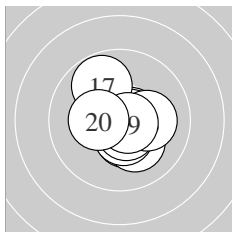

Serie 2:
 10.4 * 10.2 * 10.5 * 10.6 * 10.6 *
 10.6 * 9.8 ↘ 10.1 → 10.7 * 10.3 *
 beste Teiler 64.5 (19.) 79.1 (16.) 82.9 (15.)
 Trefferlage 0.37 mm rechts, 0.22 mm tief
 Streuwert 1.12, horizontal: 1.07, vertikal: 1.16

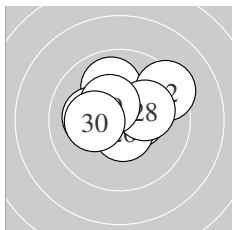

Serie 3:
 9.9 ↗ 9.3 ↗ 10.5 * 10.8 * 10.6 *
 10.6 * 10.1 ← 10.2 * 10.4 * 10.2 *
 beste Teiler 45.1 (24.) 78.8 (25.) 86.0 (26.)
 Trefferlage 0.10 mm rechts, 0.67 mm hoch
 Streuwert 1.38, horizontal: 1.68, vertikal: 1.00

Unterschrift des Schützen

Ergebnis: **309.6** (297)
 Serien: 101.8 103.5 104.3
 Zähler: 27 3 0 0 0 0 0 0 0 0
 Innenzehner: 23
 weiteste: 394 (10), 341 (6), 316 (11)
 beste Teiler 60.0 (26.) 61.4 (28.) 62.0 (14.)
 Trefferlage 0.19 mm links, 0.42 mm tief
 Streuwert 1.24, horizontal: 1.41, vertikal: 1.04

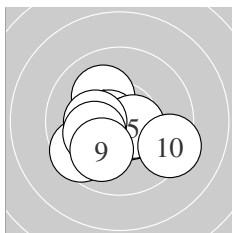
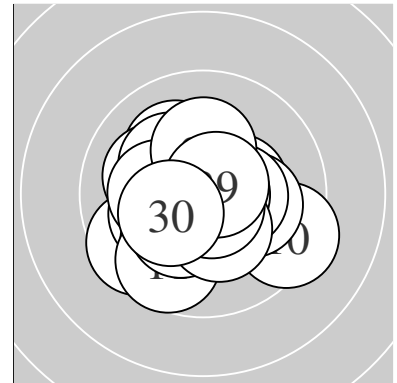

Serie 1:
 10.1 ↖ 10.5 * 10.6 * 10.6 * 10.5 *
 9.6 ↙ 10.3 * 10.2 * 10.0 ↘ 9.4 ↘
 beste Teiler 77.1 (3.) 86.2 (4.) 104.1 (5.)
 Trefferlage 0.52 mm links, 0.65 mm tief
 Streuwert 1.51, horizontal: 1.81, vertikal: 1.14

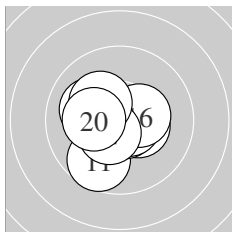

Serie 2:
 9.7 ↘ 10.6 * 10.4 * 10.7 * 10.7 *
 10.4 * 10.5 * 10.1 ↖ 10.2 * 10.2 *
 beste Teiler 62.0 (14.) 74.2 (15.) 87.9 (12.)
 Trefferlage 0.44 mm links, 0.30 mm tief
 Streuwert 1.19, horizontal: 1.29, vertikal: 1.09

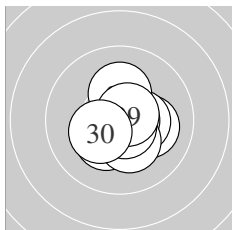

Serie 3:
 10.1 → 10.4 * 10.3 * 10.2 * 10.6 *
 10.7 * 10.3 * 10.7 * 10.7 * 10.3 *
 beste Teiler 60.0 (26.) 61.4 (28.) 67.4 (29.)
 Trefferlage 0.37 mm rechts, 0.32 mm tief
 Streuwert 0.97, horizontal: 0.98, vertikal: 0.96

Unterschrift des Schützen

Ergebnis: **308.3** (295)
 Serien: 102.9 103.1 102.3
 Zähler: 25 5 0 0 0 0 0 0 0 0
 Innenzehner: 18
 weiteste: 346 (13), 331 (25), 313 (22)
 beste Teiler 21.2 (3.) 53.1 (11.) 70.5 (6.)
 Trefferlage 0.28 mm links, 0.39 mm hoch
 Streuwert 1.32, horizontal: 1.50, vertikal: 1.11

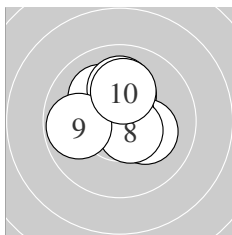
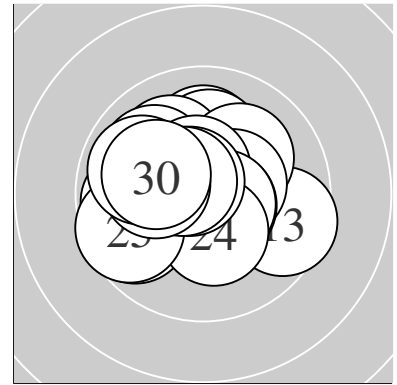

Serie 1:
 10.2 * 10.2 * 10.9 * 10.2 * 10.1 ↘
 10.7 * 10.1 ↑ 10.6 * 9.8 ← 10.1 ↑
 beste Teiler 21.2 (3.) 70.5 (6.) 96.4 (8.)
 Trefferlage 0.07 mm links, 0.84 mm hoch
 Streuwert 1.19, horizontal: 1.21, vertikal: 1.18

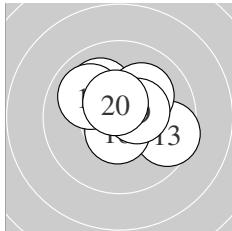

Serie 2:
 10.7 * 10.5 * 9.6 ↘ 10.1 ↘ 10.6 *
 10.6 * 10.0 ↘ 10.1 ↗ 10.4 * 10.5 *
 beste Teiler 53.1 (11.) 85.4 (15.) 97.0 (16.)
 Trefferlage 0.37 mm rechts, 0.54 mm hoch
 Streuwert 1.27, horizontal: 1.51, vertikal: 0.99

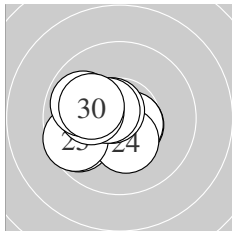

Serie 3:
 10.6 * 9.7 ← 10.6 * 10.3 * 9.6 ←
 10.7 * 10.6 * 10.2 * 9.9 ↖ 10.1 ↖
 beste Teiler 74.9 (26.) 85.0 (23.) 91.0 (21.)
 Trefferlage 1.16 mm links, 0.20 mm tief
 Streuwert 1.25, horizontal: 1.47, vertikal: 0.98

Unterschrift des Schützen

Ergebnis: **312.6** (297)
 Serien: 105.3 104.9 102.4
 Zähler: 27 3 0 0 0 0 0 0 0 0
 Innenzehner: 25
 weiteste: 388 (11), 330 (27), 313 (22)
 beste Teiler 48.3 (13.) 51.8 (3.) 52.8 (18.)
 Trefferlage 0.12 mm links, 0.46 mm hoch
 Streuwert 1.08, horizontal: 1.26, vertikal: 0.85

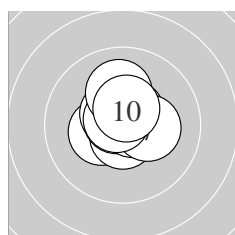
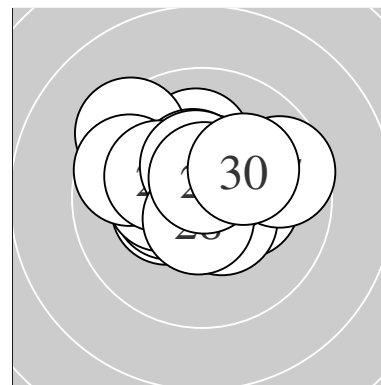

Serie 1:
 10.4 * 10.7 * 10.7 * 10.6 * 10.6 *
 10.7 * 10.3 * 10.7 * 10.1 ↑ 10.5 *
 beste Teiler 51.8 (3.) 57.2 (8.) 70.3 (6.)
 Trefferlage 0.01 mm rechts, 0.43 mm hoch
 Streuwert 0.84, horizontal: 0.85, vertikal: 0.84

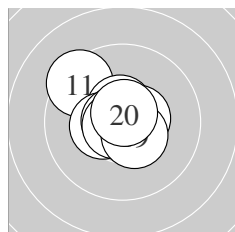

Serie 2:
 9.4 ↘ 10.6 * 10.8 * 10.6 * 10.4 *
 10.7 * 10.5 * 10.7 * 10.5 * 10.7 *
 beste Teiler 48.3 (13.) 52.8 (18.) 55.7 (16.)
 Trefferlage 0.26 mm links, 0.20 mm hoch
 Streuwert 1.08, horizontal: 1.15, vertikal: 1.01

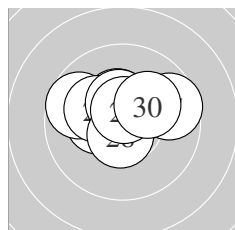

Serie 3:
 10.3 * 9.7 ↙ 10.4 * 10.5 * 10.2 *
 10.4 * 9.6 → 10.6 * 10.6 * 10.1 ↗
 beste Teiler 81.4 (29.) 85.3 (28.) 118.9 (24.)
 Trefferlage 0.12 mm links, 0.77 mm hoch
 Streuwert 1.32, horizontal: 1.75, vertikal: 0.67

Unterschrift des Schützen

Meyton Elektronik

Ergebnis: **303.2** (292)
 Serien: 101.1 100.6 101.5
 Zähler: 22 8 0 0 0 0 0 0 0 0
 Innenzehner: 16
 weiteste: 474 (21), 438 (10), 379 (20)
 beste Teiler 90.0 (7.) 92.0 (19.) 92.0 (29.)
 Trefferlage 0.17 mm links, 1.12 mm tief
 Streuwert 1.48, horizontal: 1.81, vertikal: 1.05

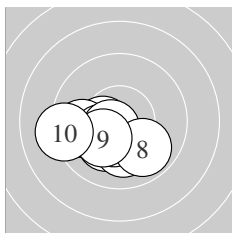
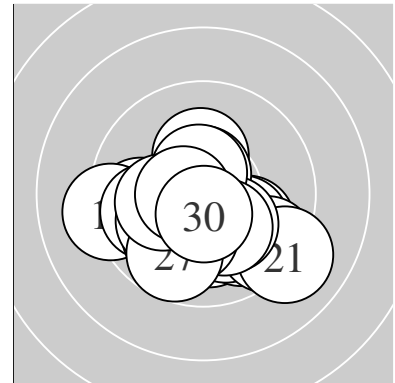

Serie 1:
 10.2 * 10.4 * 9.8 ← 10.3 * 10.1 ↓
 10.4 * 10.6 * 9.9 ↘ 10.2 * 9.2 ←
 beste Teiler 90.0 (7.) 133.6 (2.) 136.6 (6.)
 Trefferlage 1.13 mm links, 1.16 mm tief
 Streuwert 1.25, horizontal: 1.65, vertikal: 0.62

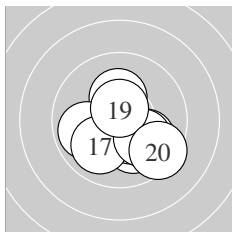

Serie 2:
 10.3 * 9.8 ↘ 10.0 ↘ 9.9 ← 10.1 ↓
 10.4 * 10.0 ↙ 10.1 ↘ 10.6 * 9.4 ↘
 beste Teiler 92.0 (19.) 143.0 (16.) 175.4 (11.)
 Trefferlage 0.68 mm rechts, 1.00 mm tief
 Streuwert 1.55, horizontal: 1.75, vertikal: 1.32

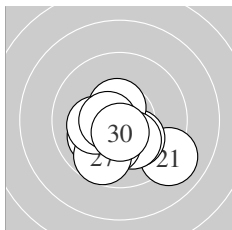

Serie 3:
 9.1 ↘ 10.2 * 10.1 ← 10.6 * 10.2 *
 10.2 * 9.7 ↙ 10.2 * 10.6 * 10.6 *
 beste Teiler 92.0 (29.) 94.0 (30.) 100.0 (24.)
 Trefferlage 0.06 mm links, 1.20 mm tief
 Streuwert 1.48, horizontal: 1.73, vertikal: 1.18

Unterschrift des Schützen

Ergebnis: **278.7** (265)
 Serien: 93.9 88.8 96.0
 Zähler: 6 18 2 3 1 0 0 0 0 0
 Innenzehner: 2
 weiteste: 1038 (18), 886 (17), 838 (16)
 beste Teiler 134.5 (28.) 184.7 (5.) 209.9 (11.)
 Trefferlage 1.89 mm rechts, 1.97 mm tief
 Streuwert 2.74, horizontal: 2.87, vertikal: 2.61

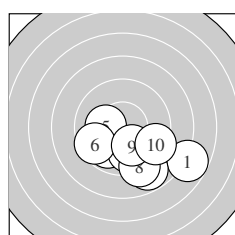
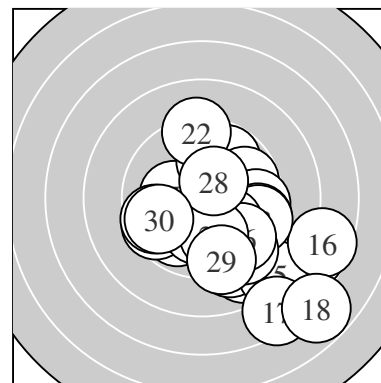

Serie 1:
 7.8 ↘ 9.9 ↙ 9.8 ↓ 9.3 ↘ 10.2 *
 9.6 ↙ 8.8 ↘ 9.1 ↓ 10.1 ↓ 9.3 ↘
 beste Teiler 184.7 (5.) 223.1 (9.) 274.2 (2.)
 Trefferlage 1.29 mm rechts, 2.60 mm tief
 Streuwert 2.33, horizontal: 2.98, vertikal: 1.40

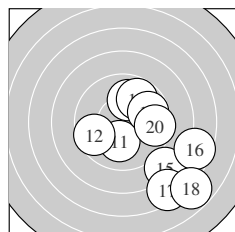

Serie 2:
 10.1 ↓ 9.6 ↙ 10.0 ↑ 9.8 ↗ 8.2 ↘
 7.6 ↘ 7.4 ↘ 6.8 ↘ 9.8 → 9.5 →
 beste Teiler 209.9 (11.) 246.6 (13.) 296.9 (14.)
 Trefferlage 2.98 mm rechts, 2.03 mm tief
 Streuwert 3.53, horizontal: 3.44, vertikal: 3.63

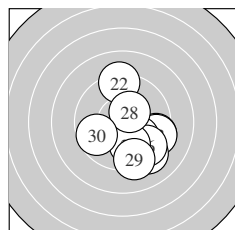

Serie 3:
 9.4 ↘ 9.2 ↑ 9.4 ↘ 9.2 ↘ 10.0 ↘
 9.5 ↘ 9.9 ↓ 10.4 * 9.3 ↓ 9.7 ↙
 beste Teiler 134.5 (28.) 234.1 (25.) 254.9 (27.)
 Trefferlage 1.39 mm rechts, 1.27 mm tief
 Streuwert 2.20, horizontal: 1.98, vertikal: 2.41

Unterschrift des Schützen

Ergebnis: **307.9** (292)
 Serien: 104.0 101.0 102.9
 Zähler: 22 8 0 0 0 0 0 0 0 0
 Innenzehner: 19
 weiteste: 297 (2), 294 (12), 284 (26)
 beste Teiler 29.8 (10.) 32.0 (5.) 68.0 (30.)
 Trefferlage 0.40 mm links, 0.63 mm tief
 Streuwert 1.25, horizontal: 1.15, vertikal: 1.35

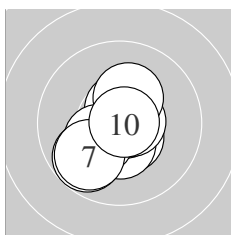
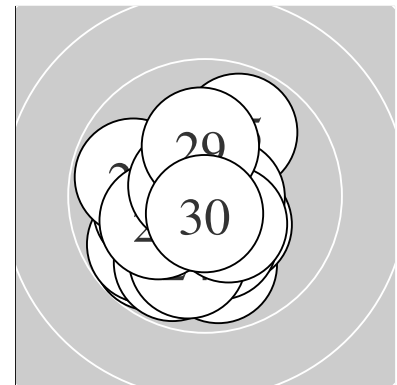

Serie 1:
 10.5 * 9.8 ↘ 10.4 * 10.6 * 10.8 *
 10.3 * 9.8 ↘ 10.7 * 10.3 * 10.8 *
 beste Teiler 29.8 (10.) 32.0 (5.) 71.8 (8.)
 Trefferlage 0.27 mm links, 0.47 mm tief
 Streuwert 1.15, horizontal: 1.07, vertikal: 1.23

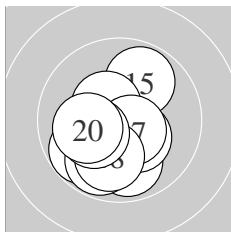

Serie 2:
 9.9 ↓ 9.8 ↘ 9.8 ↓ 10.3 * 9.8 ↗
 10.5 * 10.6 * 10.0 ↓ 10.2 * 10.1 ←
 beste Teiler 98.4 (17.) 122.3 (16.) 154.1 (14.)
 Trefferlage 0.50 mm links, 0.91 mm tief
 Streuwert 1.47, horizontal: 1.32, vertikal: 1.60

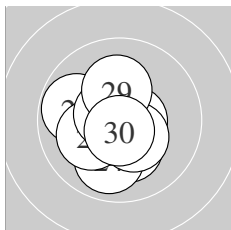

Serie 3:
 10.4 * 10.6 * 10.2 * 9.9 ↓ 10.4 *
 9.8 ← 10.1 ← 10.6 * 10.2 * 10.7 *
 beste Teiler 68.0 (30.) 80.6 (28.) 81.1 (22.)
 Trefferlage 0.44 mm links, 0.52 mm tief
 Streuwert 1.22, horizontal: 1.15, vertikal: 1.28

Unterschrift des Schützen

Ergebnis: **296.8** (283)
 Serien: 98.2 96.0 102.6
 Zähler: 15 13 2 0 0 0 0 0 0 0
 Innenzehner: 11
 weiteste: 521 (18), 502 (7), 495 (4)
 beste Teiler 61.4 (25.) 63.1 (24.) 88.0 (29.)
 Trefferlage 1.23 mm rechts, 0.77 mm tief
 Streuwert 1.86, horizontal: 1.84, vertikal: 1.87

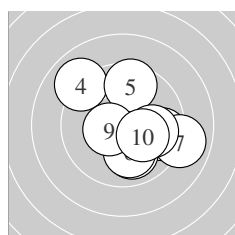
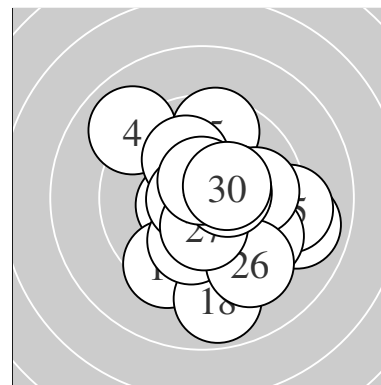

Serie 1:
 9.6 → 10.5 * 10.0 ↓ 9.0 ↘ 9.6 ↑
 10.0 ↓ 8.9 → 9.9 → 10.5 * 10.2 *
 beste Teiler 113.7 (2.) 119.5 (9.) 191.4 (10.)
 Trefferlage 1.07 mm rechts, 0.22 mm tief
 Streuwert 2.18, horizontal: 2.32, vertikal: 2.03

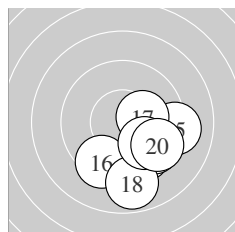

Serie 2:
 10.2 * 9.6 ↘ 9.4 → 9.6 ↘ 9.2 →
 9.4 ↙ 10.3 * 8.9 ↓ 9.9 ↘ 9.5 ↘
 beste Teiler 174.6 (17.) 200.5 (11.) 257.4 (19.)
 Trefferlage 2.00 mm rechts, 1.83 mm tief
 Streuwert 1.68, horizontal: 1.70, vertikal: 1.66

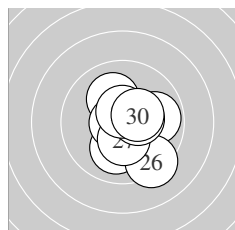

Serie 3:
 9.9 → 10.1 ↓ 10.1 ↖ 10.7 * 10.7 *
 9.3 ↘ 10.4 * 10.4 * 10.6 * 10.4 *
 beste Teiler 61.4 (25.) 63.1 (24.) 88.0 (29.)
 Trefferlage 0.63 mm rechts, 0.25 mm tief
 Streuwert 1.43, horizontal: 1.26, vertikal: 1.58

Unterschrift des Schützen

Meyton Elektronik

Ergebnis: **311.7** (299)
 Serien: 104.0 102.9 104.8
 Zähler: 29 1 0 0 0 0 0 0 0 0
 Innenzehner: 24
 weiteste: 336 (19), 239 (5), 237 (22)
 beste Teiler 12.7 (27.) 30.0 (28.) 35.2 (15.)
 Trefferlage 0.31 mm rechts, 0.07 mm tief
 Streuwert 1.11, horizontal: 1.21, vertikal: 1.01

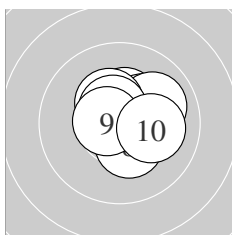
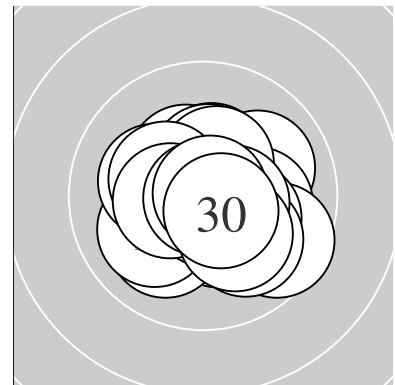

Serie 1:
 10.4 * 10.5 * 10.8 * 10.2 * 10.0 ↗
 10.4 * 10.6 * 10.4 * 10.6 * 10.1 →
 beste Teiler 46.6 (3.) 83.0 (9.) 98.3 (7.)
 Trefferlage 0.61 mm rechts, 0.41 mm hoch
 Streuwert 0.98, horizontal: 1.08, vertikal: 0.88

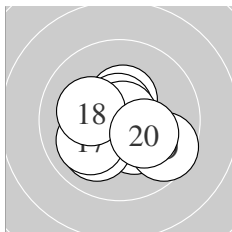

Serie 2:
 10.4 * 10.8 * 10.3 * 10.6 * 10.8 *
 10.0 ↙ 10.0 ↙ 10.2 * 9.6 ↘ 10.2 *
 beste Teiler 35.2 (15.) 36.8 (12.) 80.5 (14.)
 Trefferlage 0.03 mm rechts, 0.36 mm tief
 Streuwert 1.35, horizontal: 1.53, vertikal: 1.14

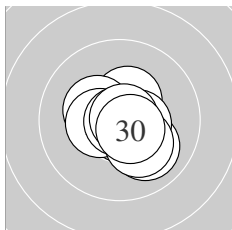

Serie 3:
 10.4 * 10.0 ↘ 10.7 * 10.3 * 10.5 *
 10.4 * 10.9 * 10.8 * 10.2 * 10.6 *
 beste Teiler 12.7 (27.) 30.0 (28.) 57.5 (23.)
 Trefferlage 0.29 mm rechts, 0.28 mm tief
 Streuwert 0.96, horizontal: 1.02, vertikal: 0.88

Unterschrift des Schützen

Ergebnis: **306.3** (293)
 Serien: 100.9 103.1 102.3
 Zähler: 23 7 0 0 0 0 0 0 0 0
 Innenzehner: 16
 weiteste: 495 (7), 388 (16), 308 (19)
 beste Teiler 11.0 (14.) 33.9 (18.) 38.3 (8.)
 Trefferlage 0.44 mm links, 0.43 mm hoch
 Streuwert 1.47, horizontal: 1.69, vertikal: 1.20

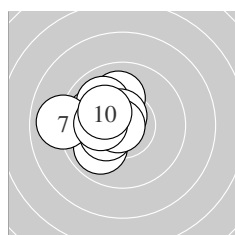
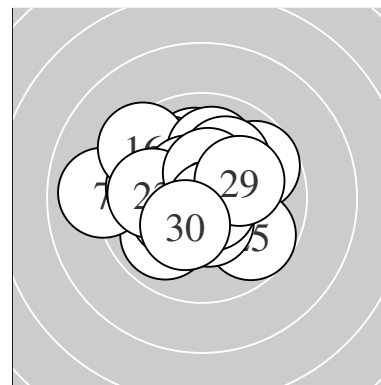

Serie 1:
 9.9 ↙ 9.9 ← 10.0 ↑ 10.0 ↘ 10.3 *
 10.6 * 9.0 ← 10.8 * 10.2 * 10.2 *
 beste Teiler 38.3 (8.) 80.0 (6.) 153.8 (5.)
 Trefferlage 1.65 mm links, 0.44 mm hoch
 Streuwert 1.29, horizontal: 1.38, vertikal: 1.19

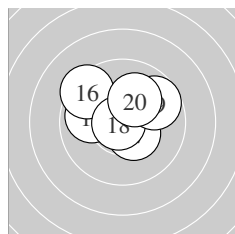

Serie 2:
 10.6 * 9.9 ← 10.6 * 10.9 * 10.7 *
 9.4 ↘ 10.4 * 10.8 * 9.7 ↗ 10.1 ↗
 beste Teiler 11.0 (14.) 33.9 (18.) 60.8 (15.)
 Trefferlage 0.03 mm rechts, 0.60 mm hoch
 Streuwert 1.42, horizontal: 1.68, vertikal: 1.09

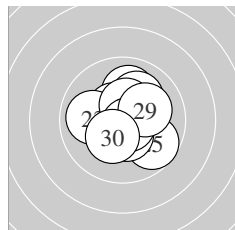

Serie 3:
 10.0 ↑ 10.5 * 10.0 ← 10.1 ↗ 9.7 ↘
 10.5 * 10.4 * 10.7 * 10.1 ↗ 10.3 *
 beste Teiler 61.0 (28.) 113.0 (22.) 123.7 (26.)
 Trefferlage 0.30 mm rechts, 0.25 mm hoch
 Streuwert 1.41, horizontal: 1.41, vertikal: 1.42

Unterschrift des Schützen

Meyton Elektronik

Ergebnis: **307.6** (297)
 Serien: 103.3 101.8 102.5
 Zähler: 27 3 0 0 0 0 0 0 0 0
 Innenzehner: 18
 weiteste: 350 (27), 296 (12), 259 (11)
 beste Teiler 64.8 (2.) 66.4 (21.) 93.1 (13.)
 Trefferlage 0.17 mm links, 0.01 mm tief
 Streuwert 1.35, horizontal: 1.53, vertikal: 1.14

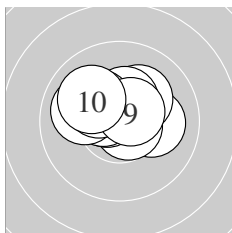
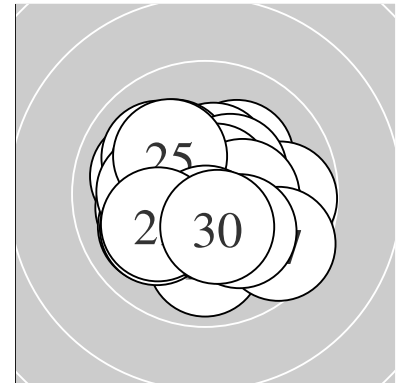

Serie 1:
 10.1 → 10.7 * 10.6 * 10.2 * 10.5 *
 10.4 * 10.0 ← 10.2 * 10.6 * 10.0 ↖
 beste Teiler 64.8 (2.) 95.7 (9.) 97.6 (3.)
 Trefferlage 0.24 mm links, 0.73 mm hoch
 Streuwert 1.11, horizontal: 1.44, vertikal: 0.62

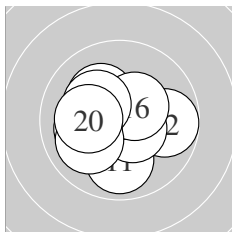

Serie 2:
 9.9 ↓ 9.8 → 10.6 * 10.2 * 10.5 *
 10.4 * 10.2 * 10.1 ← 10.0 ↙ 10.1 ←
 beste Teiler 93.1 (13.) 102.0 (15.) 134.4 (16.)
 Trefferlage 0.35 mm links, 0.08 mm tief
 Streuwert 1.48, horizontal: 1.69, vertikal: 1.23

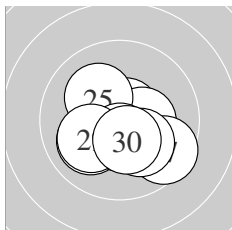

Serie 3:
 10.7 * 10.4 * 10.0 ↙ 10.5 * 10.1 ↖
 10.5 * 9.6 ↘ 10.2 * 10.1 ↙ 10.4 *
 beste Teiler 66.4 (21.) 113.0 (26.) 113.1 (24.)
 Trefferlage 0.05 mm rechts, 0.71 mm tief
 Streuwert 1.35, horizontal: 1.59, vertikal: 1.06

Unterschrift des Schützen

Ergebnis: **308.1** (297)
 Serien: 104.1 102.8 101.2
 Zähler: 27 3 0 0 0 0 0 0 0 0
 Innenzehner: 22
 weiteste: 466 (28), 325 (30), 271 (19)
 beste Teiler 31.5 (16.) 37.3 (10.) 60.0 (20.)
 Trefferlage 0.10 mm rechts, 0.43 mm tief
 Streuwert 1.35, horizontal: 1.28, vertikal: 1.41

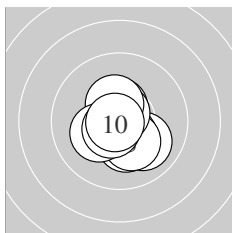
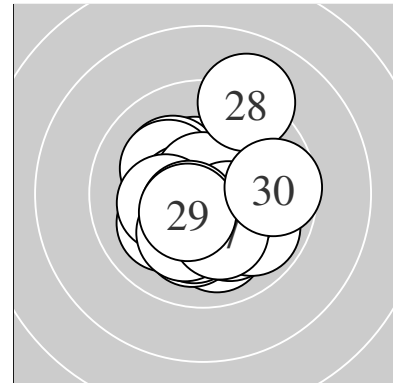

Serie 1:
 10.0 ↘ 10.3 * 10.5 * 10.4 * 10.2 *
 10.7 * 10.4 * 10.2 * 10.6 * 10.8 *
 beste Teiler 37.3 (10.) 62.5 (6.) 87.7 (9.)
 Trefferlage 0.08 mm rechts, 0.44 mm tief
 Streuwert 1.03, horizontal: 0.93, vertikal: 1.12

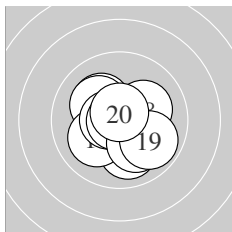

Serie 2:
 10.2 * 10.2 * 10.0 ↓ 10.1 ↙ 10.6 *
 10.8 * 10.1 ↘ 10.2 * 9.9 ↘ 10.7 *
 beste Teiler 31.5 (16.) 60.0 (20.) 84.0 (15.)
 Trefferlage 0.00 mm , 0.30 mm tief
 Streuwert 1.38, horizontal: 1.44, vertikal: 1.33

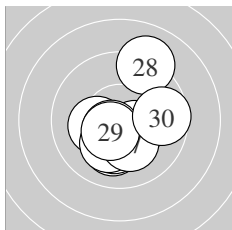

Serie 3:
 10.1 ↓ 10.2 * 10.4 * 10.6 * 10.2 *
 10.2 * 10.2 * 9.1 ↑ 10.5 * 9.7 →
 beste Teiler 96.3 (24.) 110.7 (29.) 137.5 (23.)
 Trefferlage 0.23 mm rechts, 0.56 mm tief
 Streuwert 1.69, horizontal: 1.52, vertikal: 1.84

Unterschrift des Schützen

Ergebnis: **312.1** (296)
 Serien: 103.4 104.2 104.5
 Zähler: 26 4 0 0 0 0 0 0 0 0
 Innenzehner: 22
 weiteste: 296 (10), 274 (12), 272 (15)
 beste Teiler 9.0 (19.) 36.2 (29.) 36.3 (1.)
 Trefferlage 0.13 mm rechts, 0.14 mm hoch
 Streuwert 1.13, horizontal: 1.24, vertikal: 1.00

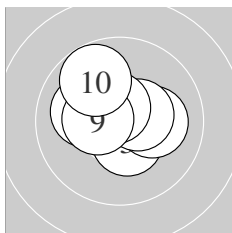
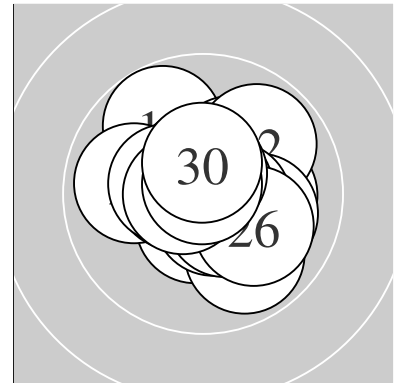

Serie 1:
 10.8 * 10.4 * 10.4 * 10.1 ↖ 10.3 *
 10.1 → 10.5 * 10.6 * 10.4 * 9.8 ↗
 beste Teiler 36.3 (1.) 89.5 (8.) 121.4 (7.)
 Trefferlage 0.10 mm links, 0.43 mm hoch
 Streuwert 1.21, horizontal: 1.38, vertikal: 1.01

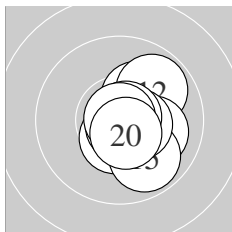

Serie 2:
 10.2 * 9.9 ↗ 10.1 ↘ 10.5 * 9.9 ↘
 10.8 * 10.5 * 10.8 * 10.9 * 10.6 *
 beste Teiler 9.0 (19.) 38.6 (16.) 42.4 (18.)
 Trefferlage 0.83 mm rechts, 0.19 mm tief
 Streuwert 1.03, horizontal: 0.84, vertikal: 1.19

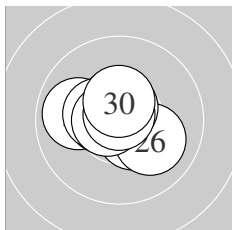

Serie 3:
 9.9 ↖ 10.5 * 10.5 * 10.6 * 10.4 *
 10.1 ↘ 10.6 * 10.6 * 10.8 * 10.5 *
 beste Teiler 36.2 (29.) 76.0 (28.) 78.4 (27.)
 Trefferlage 0.31 mm links, 0.20 mm hoch
 Streuwert 1.02, horizontal: 1.22, vertikal: 0.75

Unterschrift des Schützen

Ergebnis: **298.4** (285)
 Serien: 99.2 98.4 100.8
 Zähler: 19 8 2 1 0 0 0 0 0 0
 Innenzehner: 14
 weiteste: 796 (17), 648 (5), 575 (23)
 beste Teiler 84.5 (27.) 100.1 (20.) 101.6 (22.)
 Trefferlage 0.97 mm links, 0.37 mm hoch
 Streuwert 2.03, horizontal: 2.29, vertikal: 1.72

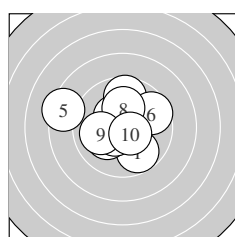
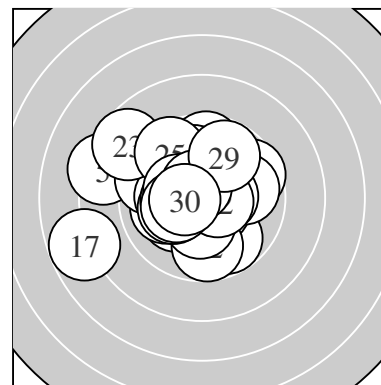

Serie 1:
 9.8 ↘ 10.2 * 10.4 * 9.7 ↑ 8.4 ↖
 9.6 ↗ 10.5 * 10.1 ↑ 10.0 ← 10.5 *
 beste Teiler 104.3 (10.) 113.1 (7.) 140.2 (3.)
 Trefferlage 0.60 mm links, 0.38 mm hoch
 Streuwert 2.17, horizontal: 2.50, vertikal: 1.79

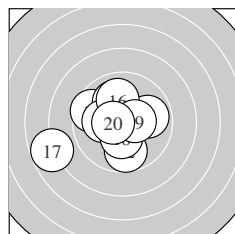

Serie 2:
 9.6 ↖ 9.7 ↓ 10.0 ↗ 9.9 → 10.1 ←
 10.0 ↑ 7.8 ↙ 10.3 * 10.4 * 10.6 *
 beste Teiler 100.1 (20.) 129.3 (19.) 158.4 (18.)
 Trefferlage 1.09 mm links, 0.12 mm tief
 Streuwert 2.36, horizontal: 2.75, vertikal: 1.88

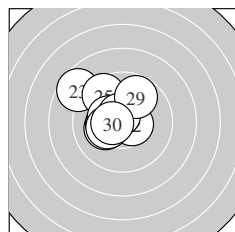

Serie 3:
 10.2 * 10.5 * 8.7 ↖ 10.3 * 9.6 ↗
 10.3 * 10.6 * 10.3 * 9.8 ↗ 10.5 *
 beste Teiler 84.5 (27.) 101.6 (22.) 109.5 (30.)
 Trefferlage 1.22 mm links, 0.84 mm hoch
 Streuwert 1.61, horizontal: 1.69, vertikal: 1.52

Unterschrift des Schützen

Meyton Elektronik

Ergebnis: **294.4** (284)
 Serien: 98.8 96.5 99.1
 Zähler: 17 10 3 0 0 0 0 0 0 0
 Innenzehner: 11
 weiteste: 632 (11), 535 (21), 516 (9)
 beste Teiler 140.4 (2.) 143.2 (4.) 149.3 (22.)
 Trefferlage 0.51 mm links, 0.43 mm tief
 Streuwert 2.23, horizontal: 2.61, vertikal: 1.77

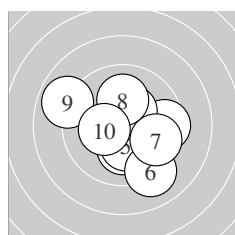
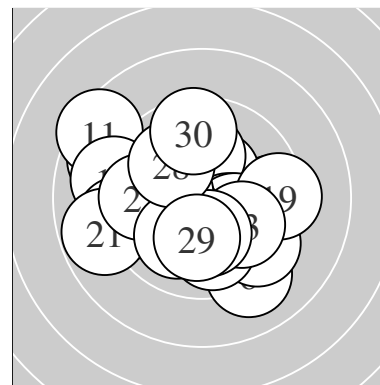

Serie 1:
 10.1 ↓ 10.4 * 9.5 → 10.4 * 10.3 *
 9.1 ↘ 9.7 ↘ 10.1 ↑ 8.9 ↖ 10.3 *
 beste Teiler 140.4 (2.) 143.2 (4.) 163.2 (10.)
 Trefferlage 0.41 mm rechts, 0.53 mm tief
 Streuwert 2.18, horizontal: 2.40, vertikal: 1.93

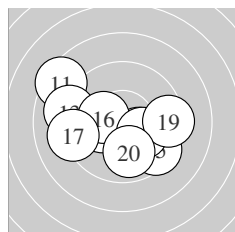

Serie 2:
 8.4 ↖ 10.2 * 9.1 ← 10.3 * 9.5 ↘
 10.3 * 9.2 ← 10.2 * 9.4 → 9.9 ↓
 beste Teiler 167.2 (14.) 170.0 (16.) 179.7 (12.)
 Trefferlage 0.71 mm links, 0.35 mm tief
 Streuwert 2.63, horizontal: 3.30, vertikal: 1.72

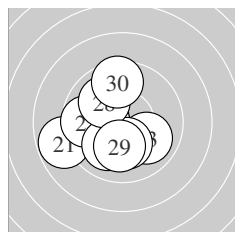

Serie 3:
 8.8 ← 10.4 * 10.0 ↘ 10.3 * 9.7 ←
 10.0 ↙ 10.2 * 10.0 ↖ 10.1 ↓ 9.6 ↑
 beste Teiler 149.3 (22.) 167.5 (24.) 186.9 (27.)
 Trefferlage 1.23 mm links, 0.41 mm tief
 Streuwert 1.88, horizontal: 1.93, vertikal: 1.84

Unterschrift des Schützen

Meyton Elektronik

Ergebnis: **304.5** (291)
 Serien: 102.7 102.3 99.5
 Zähler: 22 7 1 0 0 0 0 0 0 0
 Innenzehner: 16
 weiteste: 575 (21), 412 (19), 376 (30)
 beste Teiler 55.0 (7.) 57.5 (11.) 58.1 (9.)
 Trefferlage 0.85 mm links, 0.75 mm hoch
 Streuwert 1.44, horizontal: 1.75, vertikal: 1.05

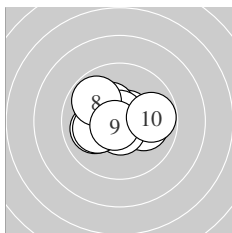
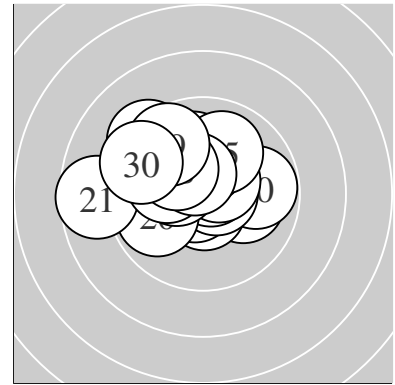

Serie 1:
 10.6 * 10.0 ← 10.1 → 10.6 * 10.3 *
 10.1 ← 10.7 * 9.8 ↖ 10.7 * 9.8 →
 beste Teiler 55.0 (7.) 58.1 (9.) 81.3 (4.)
 Trefferlage 0.18 mm links, 0.16 mm hoch
 Streuwert 1.39, horizontal: 1.74, vertikal: 0.90

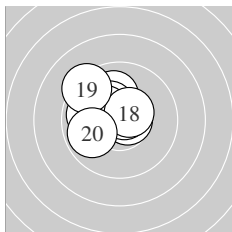

Serie 2:
 10.7 * 10.0 ↑ 10.7 * 10.3 * 10.7 *
 10.3 * 9.9 ← 10.5 * 9.3 ↖ 9.9 ←
 beste Teiler 57.5 (11.) 64.4 (15.) 72.0 (13.)
 Trefferlage 0.81 mm links, 0.78 mm hoch
 Streuwert 1.31, horizontal: 1.47, vertikal: 1.14

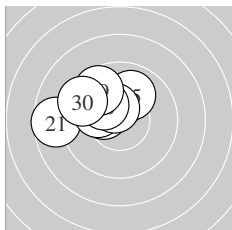

Serie 3:
 8.7 ← 10.3 * 10.4 * 10.3 * 10.0 ↗
 10.1 ↖ 10.5 * 10.2 * 9.6 ↖ 9.4 ↖
 beste Teiler 116.6 (27.) 145.2 (23.) 151.8 (22.)
 Trefferlage 1.56 mm links, 1.31 mm hoch
 Streuwert 1.47, horizontal: 1.91, vertikal: 0.84

 Unterschrift des Schützen

Ergebnis: **303.7** (294)
 Serien: 101.5 100.9 101.3
 Zähler: 24 6 0 0 0 0 0 0 0 0
 Innenzehner: 12
 weiteste: 464 (22), 459 (15), 347 (6)
 beste Teiler 41.0 (16.) 45.2 (3.) 46.2 (5.)
 Trefferlage 0.09 mm rechts, 0.31 mm tief
 Streuwert 1.65, horizontal: 1.72, vertikal: 1.57

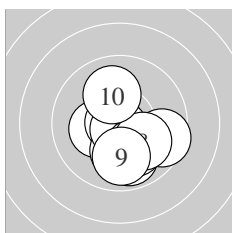
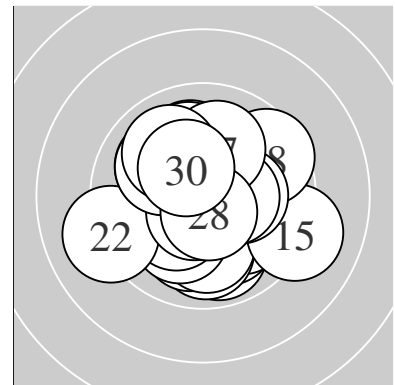

Serie 1:
 10.3 * 9.9 ↓ 10.8 * 10.1 ↓ 10.8 *
 9.6 → 10.1 ↓ 10.0 ↘ 9.9 ↓ 10.0 ↑
 beste Teiler 45.2 (3.) 46.2 (5.) 174.6 (1.)
 Trefferlage 0.42 mm rechts, 1.03 mm tief
 Streuwert 1.43, horizontal: 1.39, vertikal: 1.46

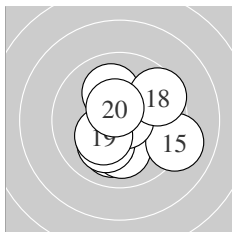

Serie 2:
 10.1 ↓ 10.3 * 10.0 ↓ 10.1 ✓ 9.1 →
 10.8 * 10.1 ↑ 9.6 ↗ 10.3 * 10.5 *
 beste Teiler 41.0 (16.) 101.5 (20.) 156.6 (12.)
 Trefferlage 0.53 mm rechts, 0.38 mm tief
 Streuwert 1.75, horizontal: 1.83, vertikal: 1.66

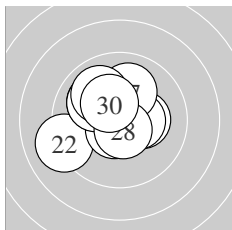

Serie 3:
 10.3 * 9.1 ← 10.6 * 10.4 * 10.0 ↘
 10.0 ↘ 10.0 ↑ 10.6 * 10.0 ↘ 10.3 *
 beste Teiler 79.7 (28.) 84.1 (23.) 131.0 (24.)
 Trefferlage 0.67 mm links, 0.49 mm hoch
 Streuwert 1.58, horizontal: 1.79, vertikal: 1.33

Unterschrift des Schützen

Ergebnis: **301.5** (291)
 Serien: 96.8 102.9 101.8
 Zähler: 21 9 0 0 0 0 0 0 0 0
 Innenzehner: 15
 weiteste: 489 (6), 483 (9), 478 (1)
 beste Teiler 27.5 (16.) 52.4 (11.) 96.1 (21.)
 Trefferlage 0.34 mm links, 0.11 mm hoch
 Streuwert 1.84, horizontal: 2.08, vertikal: 1.57

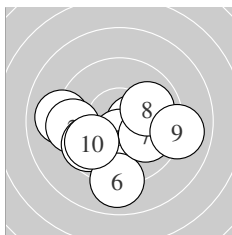
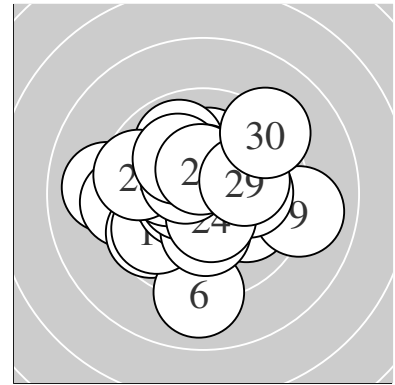

Serie 1:
 9.0 ← 9.4 ← 10.5 * 9.7 ↙ 10.4 *
 9.0 ↓ 10.0 ↘ 10.0 → 9.0 → 9.8 ↘
 beste Teiler 113.2 (3.) 126.0 (5.) 243.3 (7.)
 Trefferlage 0.34 mm links, 1.09 mm tief
 Streuwert 2.43, horizontal: 3.03, vertikal: 1.62

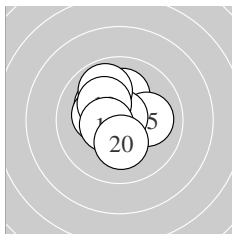

Serie 2:
 10.7 * 10.2 * 10.1 ↑ 10.2 * 10.1 →
 10.8 * 9.9 ↘ 10.2 * 10.5 * 10.2 *
 beste Teiler 27.5 (16.) 52.4 (11.) 114.1 (19.)
 Trefferlage 0.44 mm links, 0.52 mm hoch
 Streuwert 1.23, horizontal: 1.19, vertikal: 1.27

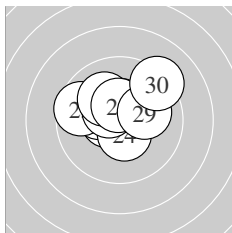

Serie 3:
 10.6 * 10.2 * 9.6 ↙ 10.5 * 10.5 *
 10.5 * 10.1 ↘ 10.5 * 10.1 → 9.2 ↘
 beste Teiler 96.1 (21.) 116.1 (26.) 120.8 (24.)
 Trefferlage 0.25 mm links, 0.90 mm hoch
 Streuwert 1.50, horizontal: 1.82, vertikal: 1.09

Unterschrift des Schützen

Ergebnis: **309.0** (296)
 Serien: 103.2 104.1 101.7
 Zähler: 26 4 0 0 0 0 0 0 0 0
 Innenzehner: 21
 weiteste: 499 (23), 262 (28), 261 (2)
 beste Teiler 40.7 (26.) 53.8 (11.) 59.2 (30.)
 Trefferlage 0.06 mm rechts, 0.27 mm tief
 Streuwert 1.35, horizontal: 1.52, vertikal: 1.14

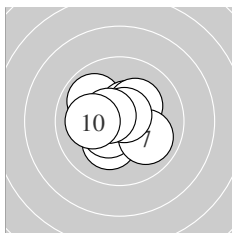
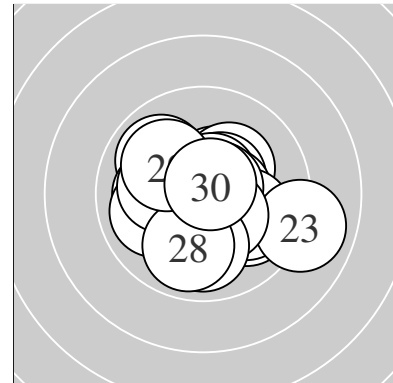

Serie 1:
 10.5 * 9.9 ↘ 10.2 * 10.5 * 10.5 *
 10.2 * 10.0 ↘ 10.7 * 10.6 * 10.1 ←
 beste Teiler 62.8 (8.) 100.1 (9.) 117.1 (4.)
 Trefferlage 0.32 mm links, 0.02 mm hoch
 Streuwert 1.27, horizontal: 1.39, vertikal: 1.14

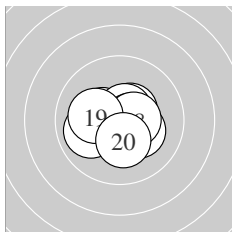

Serie 2:
 10.7 * 10.3 * 10.4 * 10.0 ← 10.5 *
 10.6 * 10.6 * 10.5 * 10.2 * 10.3 *
 beste Teiler 53.8 (11.) 84.2 (16.) 91.0 (17.)
 Trefferlage 0.09 mm links, 0.07 mm tief
 Streuwert 1.11, horizontal: 1.36, vertikal: 0.79

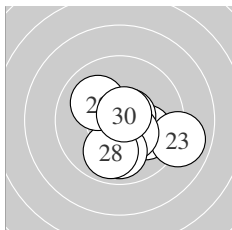

Serie 3:
 10.0 ↘ 10.3 * 9.0 ↘ 10.6 * 10.4 *
 10.8 * 9.9 ↓ 9.9 ↓ 10.1 ↘ 10.7 *
 beste Teiler 40.7 (26.) 59.2 (30.) 76.9 (24.)
 Trefferlage 0.62 mm rechts, 0.78 mm tief
 Streuwert 1.58, horizontal: 1.77, vertikal: 1.35

Unterschrift des Schützen

Ergebnis: **310.5** (298)
 Serien: 104.5 104.4 101.6
 Zähler: 28 2 0 0 0 0 0 0 0 0
 Innenzehner: 24
 weiteste: 332 (26), 301 (25), 242 (19)
 beste Teiler 48.2 (13.) 48.6 (12.) 56.3 (1.)
 Trefferlage 0.52 mm rechts, 0.29 mm tief
 Streuwert 1.12, horizontal: 1.32, vertikal: 0.87

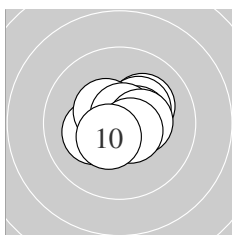
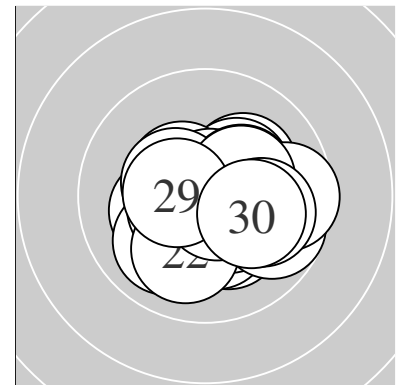

Serie 1:
 10.7 * 10.2 * 10.3 * 10.5 * 10.2 *
 10.4 * 10.7 * 10.4 * 10.6 * 10.5 *
 beste Teiler 56.3 (1.) 57.0 (7.) 89.8 (9.)
 Trefferlage 0.35 mm rechts, 0.19 mm hoch
 Streuwert 0.95, horizontal: 1.14, vertikal: 0.71

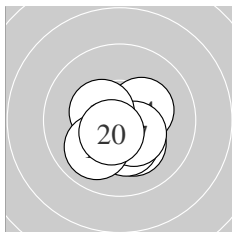

Serie 2:
 10.2 * 10.8 * 10.8 * 10.3 * 10.3 *
 10.6 * 10.4 * 10.4 * 10.0 ✓ 10.6 *
 beste Teiler 48.2 (13.) 48.6 (12.) 90.2 (16.)
 Trefferlage 0.09 mm rechts, 0.63 mm tief
 Streuwert 0.97, horizontal: 1.02, vertikal: 0.91

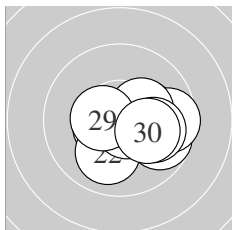

Serie 3:
 10.5 * 10.0 ↙ 10.2 * 10.7 * 9.7 →
 9.6 → 10.3 * 10.0 → 10.5 * 10.1 →
 beste Teiler 65.2 (24.) 110.0 (21.) 116.7 (29.)
 Trefferlage 1.11 mm rechts, 0.44 mm tief
 Streuwert 1.30, horizontal: 1.63, vertikal: 0.84

Unterschrift des Schützen

Ergebnis: **309.6** (294)
 Serien: 102.2 102.7 104.7
 Zähler: 24 6 0 0 0 0 0 0 0 0
 Innenzehner: 22
 weiteste: 365 (18), 351 (9), 316 (8)
 beste Teiler 39.8 (28.) 52.7 (19.) 60.8 (27.)
 Trefferlage 0.05 mm rechts, 0.48 mm hoch
 Streuwert 1.25, horizontal: 1.36, vertikal: 1.13

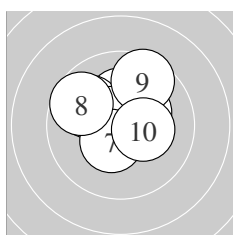
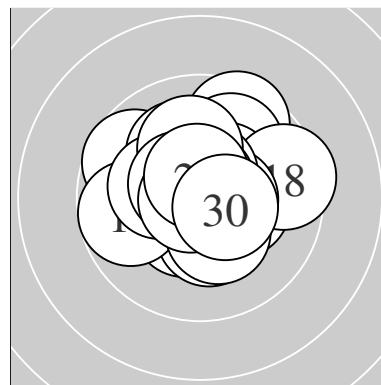

Serie 1:
 10.7 * 10.6 * 10.2 * 9.9 ↘ 10.3 *
 10.6 * 10.4 * 9.7 ↘ 9.5 ↗ 10.3 *
 beste Teiler 62.3 (1.) 84.4 (6.) 95.6 (2.)
 Trefferlage 0.05 mm links, 0.84 mm hoch
 Streuwert 1.38, horizontal: 1.54, vertikal: 1.20

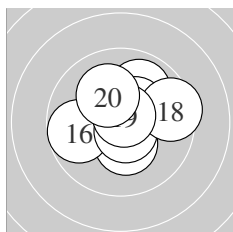

Serie 2:
 9.9 ↗ 10.4 * 10.7 * 10.7 * 10.3 *
 9.7 ← 10.7 * 9.5 → 10.7 * 10.1 ↘
 beste Teiler 52.7 (19.) 72.8 (14.) 73.4 (17.)
 Trefferlage 0.24 mm rechts, 0.24 mm hoch
 Streuwert 1.47, horizontal: 1.67, vertikal: 1.23

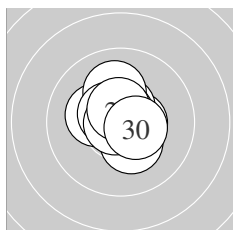

Serie 3:
 10.2 * 10.5 * 10.5 * 10.1 ↑ 10.3 *
 10.5 * 10.7 * 10.8 * 10.6 * 10.5 *
 beste Teiler 39.8 (28.) 60.8 (27.) 92.0 (29.)
 Trefferlage 0.02 mm links, 0.37 mm hoch
 Streuwert 0.91, horizontal: 0.87, vertikal: 0.94

Unterschrift des Schützen

Ergebnis: **303.1** (290)
 Serien: 101.0 101.9 100.2
 Zähler: 20 10 0 0 0 0 0 0 0 0
 Innenzehner: 14
 weiteste: 450 (28), 441 (17), 363 (12)
 beste Teiler 29.6 (15.) 81.6 (13.) 82.7 (4.)
 Trefferlage 0.34 mm links, 0.16 mm hoch
 Streuwert 1.66, horizontal: 1.99, vertikal: 1.24

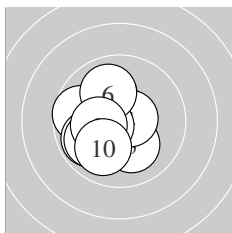
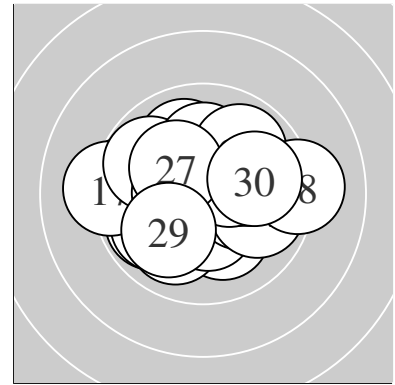

Serie 1:
 10.1 ↖ 9.7 ← 10.1 ↘ 10.6 * 10.5 *
 10.0 ↖ 9.8 ↙ 9.9 ↙ 10.3 * 10.0 ↙
 beste Teiler 82.7 (4.) 117.0 (5.) 168.2 (9.)
 Trefferlage 1.17 mm links, 0.23 mm tief
 Streuwert 1.41, horizontal: 1.29, vertikal: 1.53

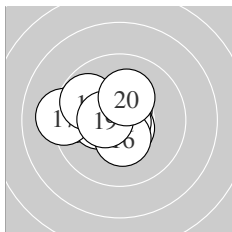

Serie 2:
 10.6 * 9.5 ← 10.6 * 10.3 * 10.8 *
 10.4 * 9.2 ← 9.8 ↘ 10.5 * 10.2 *
 beste Teiler 29.6 (15.) 81.6 (13.) 88.0 (11.)
 Trefferlage 1.13 mm links, 0.26 mm hoch
 Streuwert 1.46, horizontal: 1.84, vertikal: 0.94

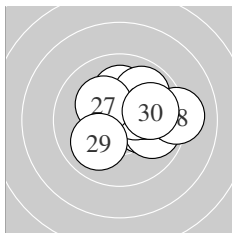

Serie 3:
 10.4 * 10.2 * 10.1 ↑ 9.9 → 10.4 *
 9.9 ↗ 10.2 * 9.2 → 10.0 ↙ 9.9 →
 beste Teiler 131.9 (21.) 142.2 (25.) 178.1 (27.)
 Trefferlage 1.27 mm rechts, 0.45 mm hoch
 Streuwert 1.55, horizontal: 1.84, vertikal: 1.20

Unterschrift des Schützen

Ergebnis: **307.5** (293)
 Serien: 100.9 103.4 103.2
 Zähler: 23 7 0 0 0 0 0 0 0 0
 Innenzehner: 21
 weiteste: 382 (8), 354 (22), 346 (28)
 beste Teiler 46.2 (21.) 57.0 (19.) 57.0 (26.)
 Trefferlage 0.16 mm links, 0.20 mm tief
 Streuwert 1.42, horizontal: 1.43, vertikal: 1.41

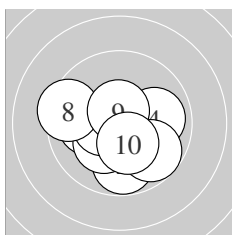
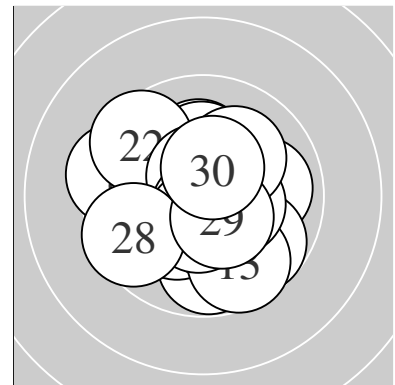

Serie 1:
 10.3 * 9.8 ↓ 10.1 ← 9.9 → 9.8 ↘
 10.2 * 10.5 * 9.4 ← 10.6 * 10.3 *
 beste Teiler 89.4 (9.) 118.6 (7.) 156.5 (10.)
 Trefferlage 0.27 mm links, 0.74 mm tief
 Streuwert 1.63, horizontal: 1.90, vertikal: 1.31

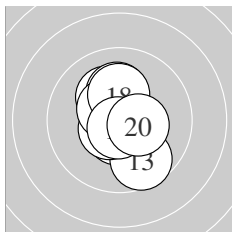

Serie 2:
 10.5 * 10.4 * 9.7 ↘ 10.6 * 10.2 *
 10.2 * 10.5 * 10.2 * 10.7 * 10.4 *
 beste Teiler 57.0 (19.) 96.6 (14.) 101.4 (11.)
 Trefferlage 0.05 mm rechts, 0.02 mm tief
 Streuwert 1.27, horizontal: 0.89, vertikal: 1.56

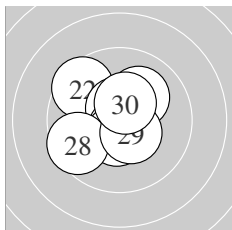

Serie 3:
 10.8 * 9.5 ↖ 10.6 * 10.5 * 10.1 ↗
 10.7 * 10.5 * 9.6 ↙ 10.5 * 10.4 *
 beste Teiler 46.2 (21.) 57.0 (26.) 88.7 (23.)
 Trefferlage 0.26 mm links, 0.14 mm hoch
 Streuwert 1.40, horizontal: 1.45, vertikal: 1.34

Unterschrift des Schützen

Ergebnis: **307.0** (295)
 Serien: 102.5 103.4 101.1
 Zähler: 25 5 0 0 0 0 0 0 0 0
 Innenzehner: 20
 weiteste: 453 (30), 359 (25), 297 (8)
 beste Teiler 2.0 (10.) 56.8 (13.) 65.0 (27.)
 Trefferlage 0.02 mm links, 0.06 mm tief
 Streuwert 1.43, horizontal: 1.65, vertikal: 1.17

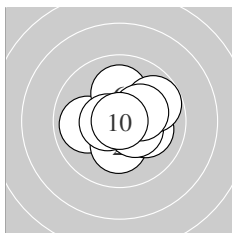
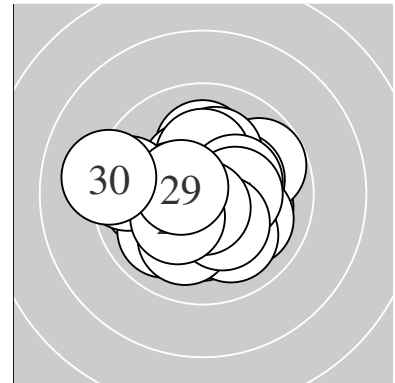

Serie 1:
 9.9 ← 10.2 * 10.1 → 10.3 * 10.4 *
 10.1 ↑ 10.6 * 9.8 ↗ 10.2 * 10.9 *
 beste Teiler 2.0 (10.) 95.4 (7.) 136.8 (5.)
 Trefferlage 0.52 mm rechts, 0.15 mm hoch
 Streuwert 1.36, horizontal: 1.55, vertikal: 1.15

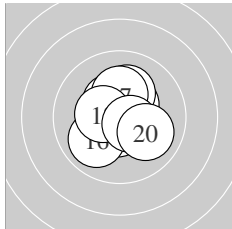

Serie 2:
 10.4 * 10.6 * 10.7 * 10.4 * 10.2 *
 9.9 ↙ 10.2 * 10.4 * 10.6 * 10.0 ↘
 beste Teiler 56.8 (13.) 91.2 (12.) 100.1 (19.)
 Trefferlage 0.00 mm , 0.13 mm hoch
 Streuwert 1.21, horizontal: 1.14, vertikal: 1.27

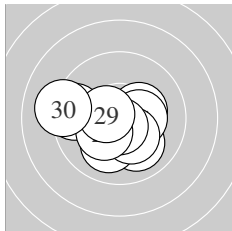

Serie 3:
 10.0 ↘ 10.3 * 10.1 ↓ 10.3 * 9.5 ←
 10.3 * 10.7 * 10.3 * 10.5 * 9.1 ←
 beste Teiler 65.0 (27.) 109.4 (29.) 153.0 (24.)
 Trefferlage 0.58 mm links, 0.49 mm tief
 Streuwert 1.67, horizontal: 2.10, vertikal: 1.08

Unterschrift des Schützen

Ergebnis: **315.9** (300)
 Serien: 104.7 106.1 105.1
 Zähler: 30 0 0 0 0 0 0 0 0 0
 Innenzehner: 29
 weiteste: 246 (17), 199 (6), 196 (27)
 beste Teiler 9.2 (19.) 10.6 (15.) 19.8 (12.)
 Trefferlage 0.08 mm links, 0.34 mm hoch
 Streuwert 0.84, horizontal: 1.02, vertikal: 0.59

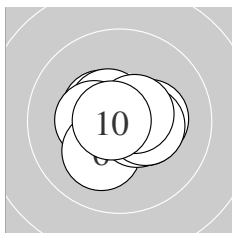
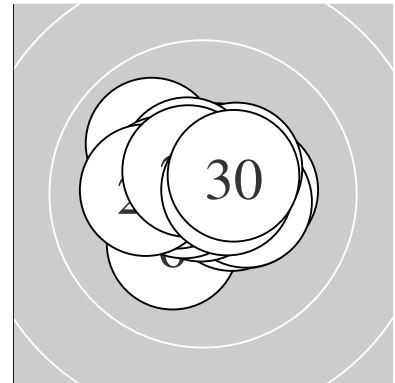

Serie 1:
 10.4 * 10.5 * 10.3 * 10.6 * 10.4 *
 10.2 * 10.5 * 10.4 * 10.6 * 10.8 *
 beste Teiler 45.1 (10.) 94.3 (9.) 98.4 (4.)
 Trefferlage 0.17 mm rechts, 0.06 mm tief
 Streuwert 0.99, horizontal: 1.21, vertikal: 0.69

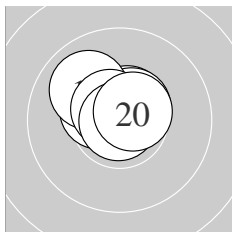

Serie 2:
 10.6 * 10.9 * 10.4 * 10.6 * 10.9 *
 10.6 * 10.0 ↘ 10.6 * 10.9 * 10.6 *
 beste Teiler 9.2 (19.) 10.6 (15.) 19.8 (12.)
 Trefferlage 0.10 mm links, 0.57 mm hoch
 Streuwert 0.69, horizontal: 0.83, vertikal: 0.50

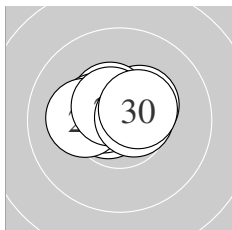

Serie 3:
 10.4 * 10.5 * 10.4 * 10.7 * 10.6 *
 10.6 * 10.2 * 10.6 * 10.6 * 10.5 *
 beste Teiler 65.1 (24.) 83.3 (29.) 86.2 (26.)
 Trefferlage 0.33 mm links, 0.51 mm hoch
 Streuwert 0.77, horizontal: 1.03, vertikal: 0.34

Unterschrift des Schützen

Ergebnis: **309.6** (297)
 Serien: 102.2 104.4 103.0
 Zähler: 27 3 0 0 0 0 0 0 0 0
 Innenzehner: 23
 weiteste: 385 (30), 276 (10), 268 (8)
 beste Teiler 29.1 (16.) 38.4 (29.) 68.5 (4.)
 Trefferlage 0.17 mm links, 0.62 mm hoch
 Streuwert 1.19, horizontal: 1.38, vertikal: 0.96

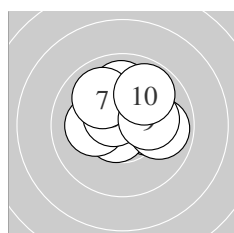
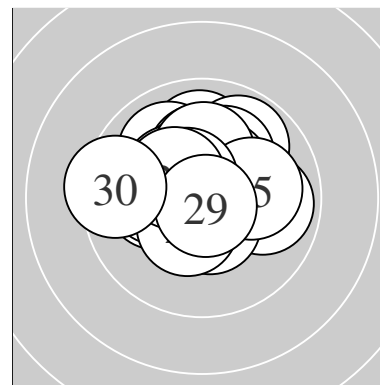

Serie 1:
 10.2 * 10.0 ↑ 10.6 * 10.7 * 10.2 *
 10.6 * 10.0 ↘ 9.9 → 10.2 * 9.8 ↗
 beste Teiler 68.5 (4.) 82.9 (3.) 95.4 (6.)
 Trefferlage 0.25 mm rechts, 0.68 mm hoch
 Streuwert 1.40, horizontal: 1.63, vertikal: 1.13

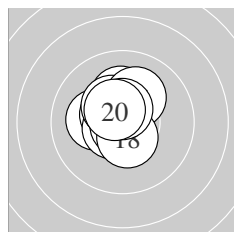

Serie 2:
 10.2 * 10.5 * 10.6 * 10.2 * 10.4 *
 10.8 * 10.1 ↗ 10.5 * 10.6 * 10.5 *
 beste Teiler 29.1 (16.) 85.4 (13.) 96.0 (19.)
 Trefferlage 0.39 mm links, 0.56 mm hoch
 Streuwert 0.88, horizontal: 0.78, vertikal: 0.97

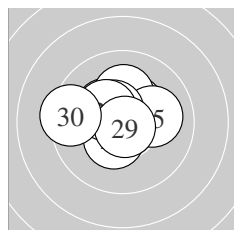

Serie 3:
 10.3 * 10.4 * 10.5 * 10.2 * 10.1 →
 10.5 * 10.4 * 10.4 * 10.8 * 9.4 ←
 beste Teiler 38.4 (29.) 108.0 (26.) 122.9 (23.)
 Trefferlage 0.37 mm links, 0.62 mm hoch
 Streuwert 1.28, horizontal: 1.59, vertikal: 0.87

Unterschrift des Schützen

Ergebnis: **307.2** (294)
 Serien: 104.1 101.4 101.7
 Zähler: 24 6 0 0 0 0 0 0 0 0
 Innenzehner: 18
 weiteste: 393 (17), 310 (18), 308 (23)
 beste Teiler 70.2 (9.) 73.7 (7.) 76.6 (4.)
 Trefferlage 0.50 mm links, 0.37 mm hoch
 Streuwert 1.35, horizontal: 1.26, vertikal: 1.43

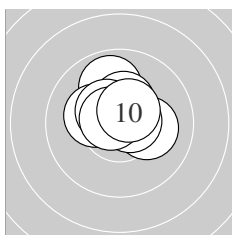
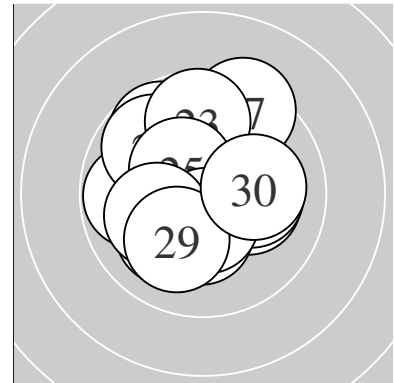

Serie 1:
 10.2 * 9.9 ↑ 10.4 * 10.6 * 10.4 *
 10.2 * 10.7 * 10.5 * 10.7 * 10.5 *
 beste Teiler 70.2 (9.) 73.7 (7.) 76.6 (4.)
 Trefferlage 0.22 mm links, 0.75 mm hoch
 Streuwert 0.96, horizontal: 1.10, vertikal: 0.79

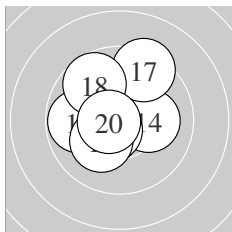

Serie 2:
 10.1 ↑ 10.5 * 10.4 * 10.1 → 9.8 ←
 10.6 * 9.4 ↑ 9.7 ↘ 10.2 * 10.6 *
 beste Teiler 76.9 (20.) 94.9 (16.) 122.9 (12.)
 Trefferlage 0.63 mm links, 0.49 mm hoch
 Streuwert 1.56, horizontal: 1.48, vertikal: 1.64

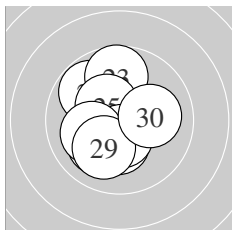

Serie 3:
 10.6 * 9.8 ↘ 9.7 ↑ 10.1 ✓ 10.4 *
 10.3 * 10.5 * 10.1 ← 10.1 ✓ 10.1 →
 beste Teiler 93.1 (21.) 114.8 (27.) 135.9 (25.)
 Trefferlage 0.65 mm links, 0.11 mm tief
 Streuwert 1.48, horizontal: 1.24, vertikal: 1.69

Unterschrift des Schützen

Meyton Elektronik

Ergebnis: **305.1** (290)
 Serien: 102.0 101.8 101.3
 Zähler: 20 10 0 0 0 0 0 0 0 0
 Innenzehner: 16
 weiteste: 353 (6), 341 (14), 336 (12)
 beste Teiler 28.0 (9.) 59.0 (15.) 66.7 (27.)
 Trefferlage 0.64 mm links, 0.01 mm tief
 Streuwert 1.50, horizontal: 1.67, vertikal: 1.29

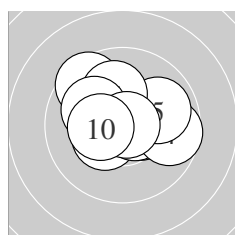
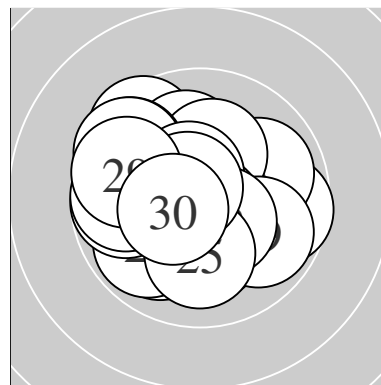

Serie 1:
 10.4 * 10.5 * 10.6 * 9.7 → 9.9 →
 9.5 ↘ 10.1 ↑ 10.1 ↖ 10.8 * 10.4 *
 beste Teiler 28.0 (9.) 84.3 (3.) 123.5 (2.)
 Trefferlage 0.04 mm rechts, 0.51 mm hoch
 Streuwert 1.54, horizontal: 1.85, vertikal: 1.16

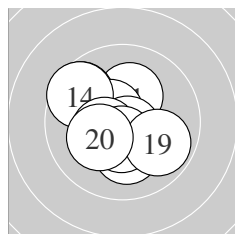

Serie 2:
 10.2 * 9.6 ↖ 10.5 * 9.6 ↖ 10.7 *
 10.4 * 10.2 * 10.5 * 9.9 ↘ 10.2 *
 beste Teiler 59.0 (15.) 105.6 (13.) 116.2 (18.)
 Trefferlage 0.59 mm links, 0.05 mm tief
 Streuwert 1.53, horizontal: 1.61, vertikal: 1.45

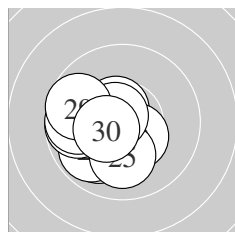

Serie 3:
 10.6 * 10.4 * 10.0 ↙ 9.9 ↙ 10.1 ↓
 9.7 ← 10.7 * 9.7 ← 9.7 ↖ 10.5 *
 beste Teiler 66.7 (27.) 96.1 (21.) 119.2 (30.)
 Trefferlage 1.39 mm links, 0.51 mm tief
 Streuwert 1.28, horizontal: 1.37, vertikal: 1.17

Unterschrift des Schützen

Meyton Elektronik

Ergebnis: **297.7** (284)
 Serien: 97.0 100.7 100.0
 Zähler: 14 16 0 0 0 0 0 0 0 0
 Innenzehner: 11
 weiteste: 471 (2), 461 (22), 449 (16)
 beste Teiler 9.0 (12.) 69.2 (29.) 69.3 (13.)
 Trefferlage 0.39 mm links, 0.78 mm hoch
 Streuwert 1.99, horizontal: 1.97, vertikal: 2.00

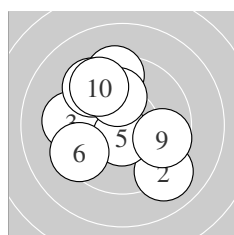
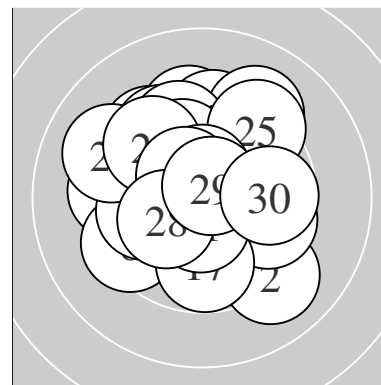

Serie 1:
 10.2 * 9.1 ↘ 9.4 ← 9.4 ↑ 10.6 *
 9.4 ↙ 9.5 ↘ 10.1 ↑ 9.7 → 9.6 ↘
 beste Teiler 86.1 (5.) 197.4 (1.) 218.5 (8.)
 Trefferlage 0.81 mm links, 0.44 mm hoch
 Streuwert 2.40, horizontal: 2.39, vertikal: 2.41

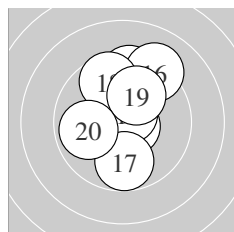

Serie 2:
 9.5 ↑ 10.9 * 10.7 * 10.4 * 10.7 *
 9.2 ↗ 9.8 ↓ 9.6 ↘ 10.0 ↗ 9.9 ←
 beste Teiler 9.0 (12.) 69.3 (13.) 75.7 (15.)
 Trefferlage 0.01 mm rechts, 0.87 mm hoch
 Streuwert 1.84, horizontal: 1.39, vertikal: 2.19

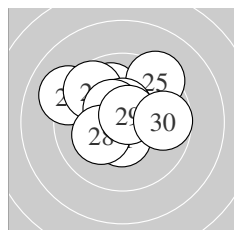

Serie 3:
 10.5 * 9.1 ↖ 10.0 ↖ 9.6 ↖ 9.3 ↗
 10.5 * 10.4 * 10.2 * 10.7 * 9.7 →
 beste Teiler 69.2 (29.) 110.0 (26.) 116.1 (21.)
 Trefferlage 0.37 mm links, 1.05 mm hoch
 Streuwert 1.82, horizontal: 2.13, vertikal: 1.45

Unterschrift des Schützen

Meyton Elektronik

Ergebnis: **283.2** (271)
 Serien: 87.2 97.1 98.9
 Zähler: 14 12 2 1 0 0 0 0 0 0
 Innenzehner: 12
 weiteste: 5940 (8), 847 (10), 645 (14)
 beste Teiler 80.9 (27.) 106.8 (1.) 131.6 (29.)
 Trefferlage 0.94 mm rechts, 2.15 mm tief
 Streuwert 7.99, horizontal: 4.51, vertikal: 10.36

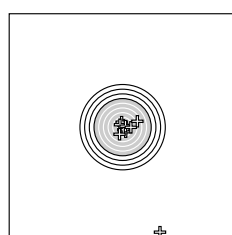
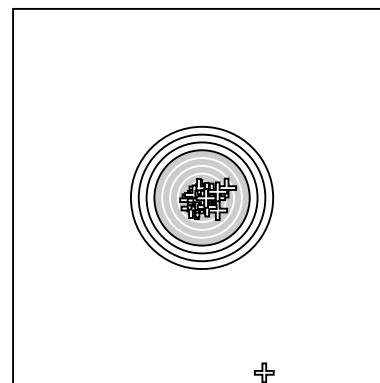

Serie 1:
 10.5 * 9.8 ↘ 10.4 * 9.9 ↑ 10.2 *
 10.3 * 9.3 ↙ 0.0 ↓ 9.2 → 7.6 →
 beste Teiler 106.8 (1.) 142.1 (3.) 162.8 (6.)
 Trefferlage 3.26 mm rechts, 5.50 mm tief
 Streuwert 13.44, horizontal: 6.51, vertikal: 17.86

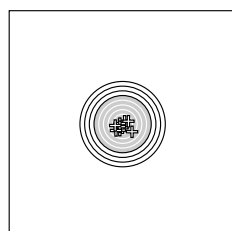

Serie 2:
 10.2 * 10.3 * 10.2 * 8.4 ↘ 10.4 *
 9.5 ↙ 10.2 * 9.0 ↙ 9.3 ← 9.6 →
 beste Teiler 149.6 (15.) 166.4 (12.) 187.0 (13.)
 Trefferlage 0.44 mm links, 1.15 mm tief
 Streuwert 2.44, horizontal: 2.82, vertikal: 2.00

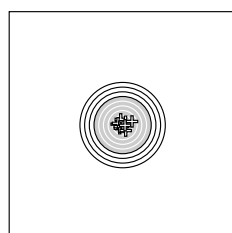

Serie 3:
 9.7 ← 9.7 ↑ 10.0 ↙ 9.9 ↖ 10.2 *
 10.0 ↗ 10.6 * 9.6 ↘ 10.4 * 8.8 →
 beste Teiler 80.9 (27.) 131.6 (29.) 176.7 (25.)
 Trefferlage 0.01 mm rechts, 0.18 mm hoch
 Streuwert 2.16, horizontal: 2.45, vertikal: 1.82

Unterschrift des Schützen

Meyton Elektronik

Ergebnis: **307.6** (293)
 Serien: 103.3 100.5 103.8
 Zähler: 23 7 0 0 0 0 0 0 0 0
 Innenzehner: 20
 weiteste: 453 (14), 398 (18), 286 (2)
 beste Teiler 23.0 (9.) 52.7 (25.) 90.6 (4.)
 Trefferlage 0.46 mm links, 0.22 mm hoch
 Streuwert 1.38, horizontal: 1.27, vertikal: 1.49

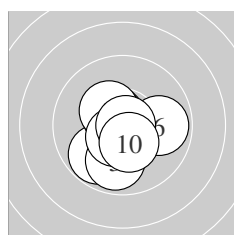
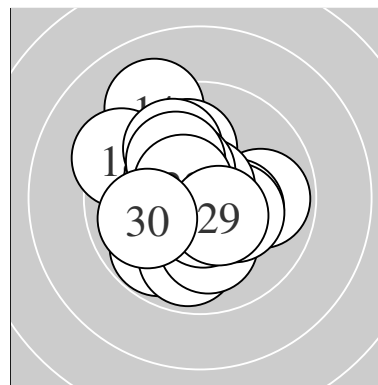

Serie 1:
 10.4 * 9.8 ↘ 9.9 ↓ 10.6 * 10.5 *
 9.9 → 10.4 * 10.5 * 10.9 * 10.4 *
 beste Teiler 23.0 (9.) 90.6 (4.) 102.3 (8.)
 Trefferlage 0.17 mm links, 0.60 mm tief
 Streuwert 1.26, horizontal: 1.22, vertikal: 1.29

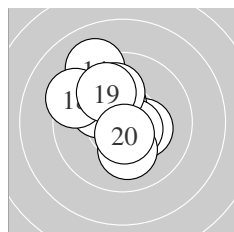

Serie 2:
 10.3 * 10.4 * 10.6 * 9.1 ↖ 10.1 ↓
 10.1 ↖ 10.0 ↖ 9.4 ↖ 9.9 ↖ 10.6 *
 beste Teiler 91.0 (20.) 94.0 (13.) 136.2 (12.)
 Trefferlage 0.67 mm links, 0.86 mm hoch
 Streuwert 1.68, horizontal: 1.51, vertikal: 1.83

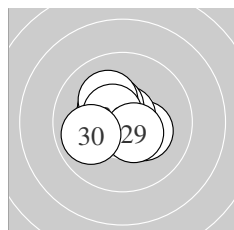

Serie 3:
 10.3 * 10.3 * 10.5 * 10.4 * 10.7 *
 10.4 * 10.2 * 10.6 * 10.5 * 9.9 ←
 beste Teiler 52.7 (25.) 97.4 (28.) 116.0 (29.)
 Trefferlage 0.55 mm links, 0.42 mm hoch
 Streuwert 1.03, horizontal: 1.14, vertikal: 0.91

Unterschrift des Schützen

Meyton Elektronik

Ergebnis: **306.4** (292)
 Serien: 102.4 102.8 101.2
 Zähler: 22 8 0 0 0 0 0 0 0 0
 Innenzehner: 19
 weiteste: 460 (22), 445 (17), 386 (23)
 beste Teiler 4.0 (13.) 48.6 (16.) 60.8 (3.)
 Trefferlage 0.13 mm links, 0.16 mm tief
 Streuwert 1.54, horizontal: 1.93, vertikal: 1.01

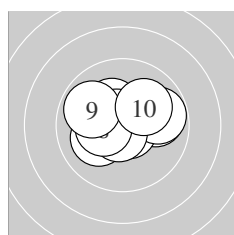
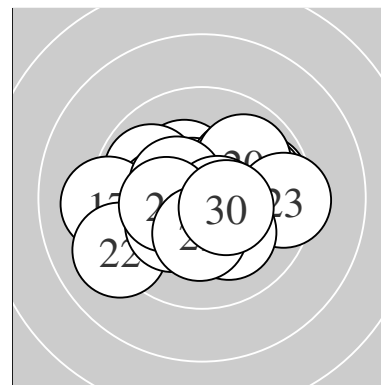

Serie 1:
 9.9 → 10.3 * 10.7 * 10.6 * 10.1 ↙
 9.8 → 10.7 * 10.3 * 9.9 ↖ 10.1 ↗
 beste Teiler 60.8 (3.) 70.6 (7.) 76.2 (4.)
 Trefferlage 0.01 mm rechts, 0.37 mm hoch
 Streuwert 1.44, horizontal: 1.83, vertikal: 0.89

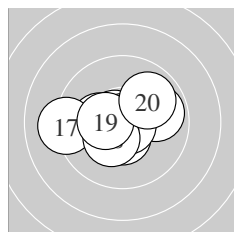

Serie 2:
 9.9 → 10.7 * 10.9 * 10.5 * 10.2 *
 10.8 * 9.2 ← 10.3 * 10.4 * 9.9 ↗
 beste Teiler 4.0 (13.) 48.6 (16.) 68.5 (12.)
 Trefferlage 0.41 mm links, 0.01 mm tief
 Streuwert 1.52, horizontal: 1.98, vertikal: 0.85

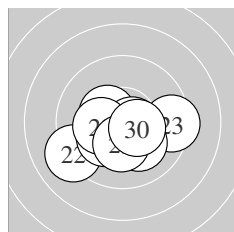

Serie 3:
 10.3 * 9.1 ↙ 9.4 → 10.2 * 10.1 ↘
 10.4 * 10.6 * 10.3 * 10.3 * 10.5 *
 beste Teiler 78.4 (27.) 122.9 (30.) 136.9 (26.)
 Trefferlage 0.00 mm , 0.86 mm tief
 Streuwert 1.65, horizontal: 2.14, vertikal: 0.93

Unterschrift des Schützen

Meyton Elektronik

Ergebnis: **313.4** (297)
 Serien: 104.0 104.2 105.2
 Zähler: 27 3 0 0 0 0 0 0 0 0
 Innenzehner: 25
 weiteste: 326 (16), 266 (12), 260 (7)
 beste Teiler 34.8 (17.) 38.1 (15.) 41.1 (21.)
 Trefferlage 0.17 mm links, 0.60 mm tief
 Streuwert 0.96, horizontal: 1.01, vertikal: 0.90

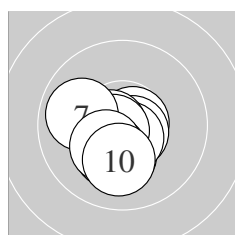
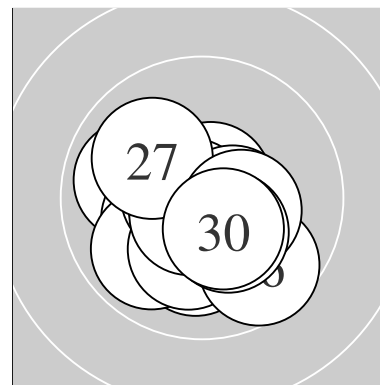

Serie 1:
 10.2 * 10.7 * 10.7 * 10.6 * 10.6 *
 10.7 * 9.9 ↙ 10.2 * 10.3 * 10.1 ↓
 beste Teiler 64.5 (2.) 68.0 (6.) 73.2 (3.)
 Trefferlage 0.44 mm links, 0.76 mm tief
 Streuwert 0.93, horizontal: 0.93, vertikal: 0.92

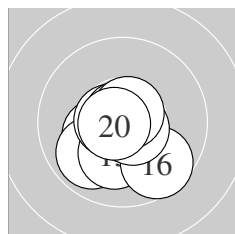

Serie 2:
 10.3 * 9.9 ↘ 10.2 * 10.6 * 10.8 *
 9.6 ↘ 10.8 * 10.6 * 10.7 * 10.7 *
 beste Teiler 34.8 (17.) 38.1 (15.) 52.9 (20.)
 Trefferlage 0.20 mm links, 0.68 mm tief
 Streuwert 1.09, horizontal: 1.13, vertikal: 1.05

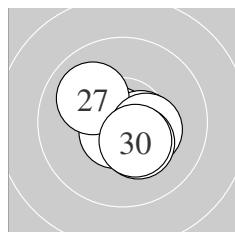

Serie 3:
 10.8 * 10.7 * 10.8 * 10.8 * 10.6 *
 10.5 * 10.0 ↘ 10.3 * 10.3 * 10.4 *
 beste Teiler 41.1 (21.) 41.3 (24.) 48.1 (23.)
 Trefferlage 0.11 mm rechts, 0.36 mm tief
 Streuwert 0.87, horizontal: 0.99, vertikal: 0.75

Unterschrift des Schützen

Ergebnis: **308.2** (294)
 Serien: 103.3 100.6 104.3
 Zähler: 24 6 0 0 0 0 0 0 0 0
 Innenzehner: 21
 weiteste: 391 (14), 294 (17), 264 (27)
 beste Teiler 45.2 (28.) 56.8 (7.) 65.7 (23.)
 Trefferlage 0.30 mm links, 0.38 mm hoch
 Streuwert 1.31, horizontal: 1.45, vertikal: 1.14

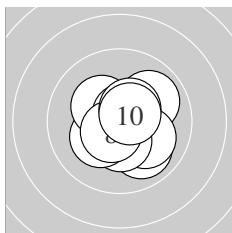
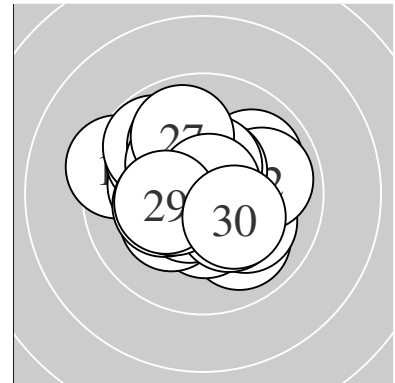

Serie 1:
 9.9 ↗ 10.0 ↘ 10.1 ↘ 10.4 * 10.2 *
 10.3 * 10.7 * 10.6 * 10.5 * 10.6 *
 beste Teiler 56.8 (7.) 91.8 (10.) 96.0 (8.)
 Trefferlage 0.41 mm rechts, 0.19 mm tief
 Streuwert 1.22, horizontal: 1.24, vertikal: 1.21

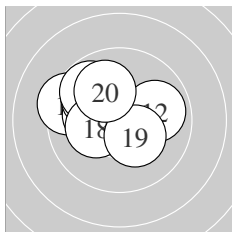

Serie 2:
 10.4 * 9.9 → 10.5 * 9.4 ← 10.2 *
 9.9 ↖ 9.8 ↖ 10.2 * 10.3 * 10.0 ↗
 beste Teiler 118.0 (13.) 133.9 (11.) 160.5 (19.)
 Trefferlage 1.07 mm links, 0.74 mm hoch
 Streuwert 1.46, horizontal: 1.77, vertikal: 1.07

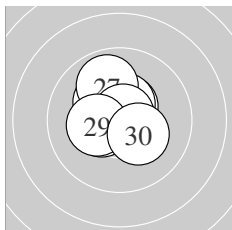

Serie 3:
 10.3 * 10.6 * 10.7 * 10.4 * 10.5 *
 10.5 * 9.9 ↖ 10.8 * 10.3 * 10.3 *
 beste Teiler 45.2 (28.) 65.7 (23.) 84.5 (22.)
 Trefferlage 0.25 mm links, 0.60 mm hoch
 Streuwert 0.98, horizontal: 0.95, vertikal: 1.01

 Unterschrift des Schützen

Ergebnis: **314.2** (299)
 Serien: 104.3 104.0 105.9
 Zähler: 29 1 0 0 0 0 0 0 0 0
 Innenzehner: 27
 weiteste: 263 (8), 233 (18), 225 (13)
 beste Teiler 14.0 (11.) 20.5 (22.) 45.1 (28.)
 Trefferlage 0.10 mm links, 0.33 mm hoch
 Streuwert 0.93, horizontal: 0.84, vertikal: 1.02

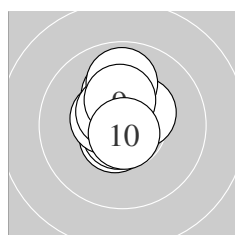
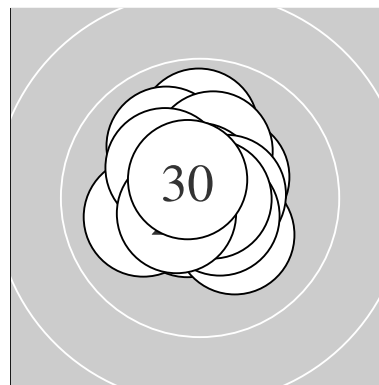

Serie 1:
 10.2 * 10.6 * 10.5 * 10.7 * 10.5 *
 10.5 * 10.4 * 9.9 ↑ 10.3 * 10.7 *
 beste Teiler 52.7 (10.) 59.0 (4.) 88.2 (2.)
 Trefferlage 0.10 mm links, 0.71 mm hoch
 Streuwert 0.92, horizontal: 0.66, vertikal: 1.11

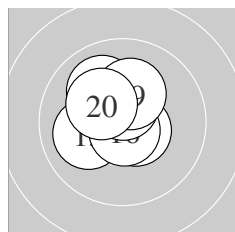

Serie 2:
 10.9 * 10.4 * 10.1 ← 10.3 * 10.6 *
 10.7 * 10.5 * 10.0 ↘ 10.2 * 10.3 *
 beste Teiler 14.0 (11.) 52.1 (16.) 97.0 (15.)
 Trefferlage 0.53 mm links, 0.57 mm hoch
 Streuwert 0.98, horizontal: 0.95, vertikal: 1.01

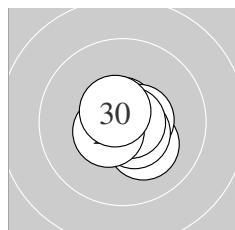

Serie 3:
 10.7 * 10.9 * 10.4 * 10.7 * 10.2 *
 10.6 * 10.5 * 10.8 * 10.5 * 10.6 *
 beste Teiler 20.5 (22.) 45.1 (28.) 57.0 (21.)
 Trefferlage 0.32 mm rechts, 0.29 mm tief
 Streuwert 0.68, horizontal: 0.71, vertikal: 0.66

 Unterschrift des Schützen

Meyton Elektronik

Ergebnis: **311.5** (299)
 Serien: 104.7 103.7 103.1
 Zähler: 29 1 0 0 0 0 0 0 0 0
 Innenzehner: 23
 weiteste: 284 (26), 238 (12), 223 (23)
 beste Teiler 17.8 (21.) 22.6 (1.) 43.6 (18.)
 Trefferlage 0.10 mm rechts, 0.17 mm hoch
 Streuwert 1.12, horizontal: 1.23, vertikal: 1.00

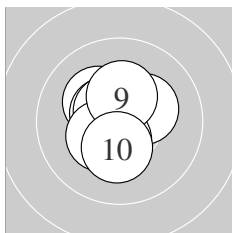
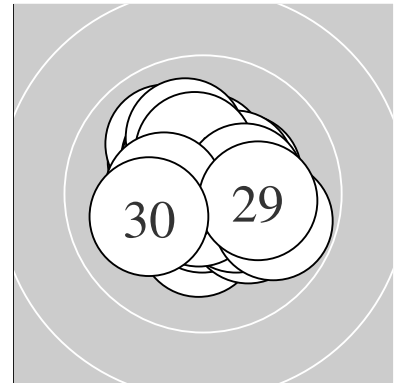

Serie 1:
 10.9 * 10.2 * 10.7 * 10.3 * 10.5 *
 10.6 * 10.5 * 10.4 * 10.3 * 10.3 *
 beste Teiler 22.6 (1.) 51.6 (3.) 93.3 (6.)
 Trefferlage 0.35 mm links, 0.08 mm hoch
 Streuwert 0.94, horizontal: 0.80, vertikal: 1.06

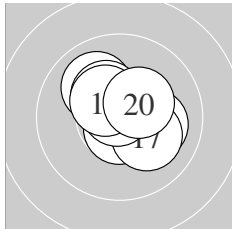

Serie 2:
 10.1 → 10.0 ↖ 10.3 * 10.7 * 10.5 *
 10.5 * 10.1 ↘ 10.8 * 10.4 * 10.3 *
 beste Teiler 43.6 (18.) 73.0 (14.) 107.3 (16.)
 Trefferlage 0.37 mm rechts, 0.36 mm hoch
 Streuwert 1.10, horizontal: 1.21, vertikal: 0.97

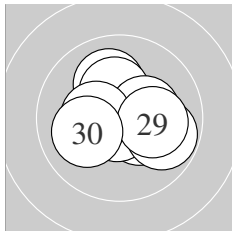

Serie 3:
 10.9 * 10.4 * 10.1 ↖ 10.7 * 10.3 *
 9.8 → 10.3 * 10.4 * 10.1 → 10.1 ←
 beste Teiler 17.8 (21.) 52.4 (24.) 144.7 (22.)
 Trefferlage 0.29 mm rechts, 0.07 mm hoch
 Streuwert 1.32, horizontal: 1.55, vertikal: 1.05

 Unterschrift des Schützen

Ergebnis: **306.4** (293)
 Serien: 102.1 101.7 102.6
 Zähler: 23 7 0 0 0 0 0 0 0 0
 Innenzehner: 15
 weiteste: 307 (22), 293 (5), 291 (18)
 beste Teiler 47.7 (19.) 56.3 (3.) 86.7 (27.)
 Trefferlage 0.47 mm links, 0.13 mm hoch
 Streuwert 1.40, horizontal: 1.60, vertikal: 1.15

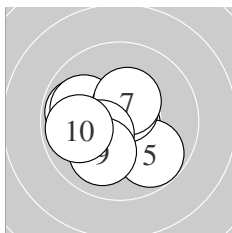
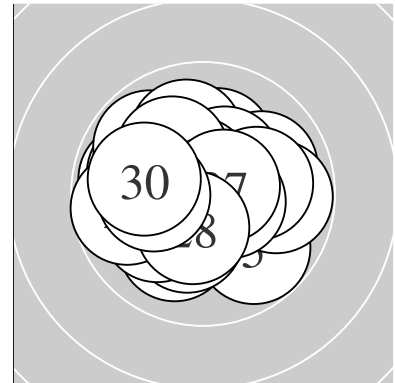

Serie 1:
 10.6 * 9.8 ← 10.7 * 10.0 ↖ 9.8 ↘
 10.6 * 10.4 * 10.3 * 10.0 ↙ 9.9 ←
 beste Teiler 56.3 (3.) 87.4 (6.) 100.0 (1.)
 Trefferlage 0.78 mm links, 0.23 mm tief
 Streuwert 1.40, horizontal: 1.58, vertikal: 1.18

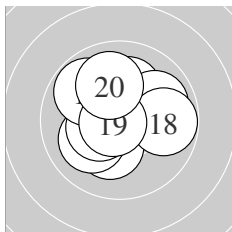

Serie 2:
 10.2 * 10.1 ↙ 10.1 ↑ 9.9 → 10.6 *
 10.4 * 9.8 ↘ 9.8 → 10.8 * 10.0 ↑
 beste Teiler 47.7 (19.) 90.2 (15.) 140.1 (16.)
 Trefferlage 0.21 mm links, 0.35 mm hoch
 Streuwert 1.53, horizontal: 1.67, vertikal: 1.38

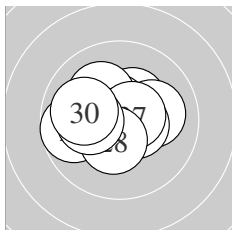

Serie 3:
 10.4 * 9.7 ← 10.1 → 10.6 * 10.5 *
 10.1 ↘ 10.6 * 10.4 * 10.2 * 10.0 ←
 beste Teiler 86.7 (27.) 86.9 (24.) 108.5 (25.)
 Trefferlage 0.44 mm links, 0.27 mm hoch
 Streuwert 1.34, horizontal: 1.68, vertikal: 0.88

Unterschrift des Schützen

Ergebnis: **308.1** (296)
 Serien: 101.6 103.4 103.1
 Zähler: 26 4 0 0 0 0 0 0 0 0
 Innenzehner: 18
 weiteste: 328 (6), 321 (13), 312 (30)
 beste Teiler 27.7 (19.) 32.8 (15.) 41.2 (27.)
 Trefferlage 0.14 mm links, 0.06 mm tief
 Streuwert 1.36, horizontal: 1.56, vertikal: 1.13

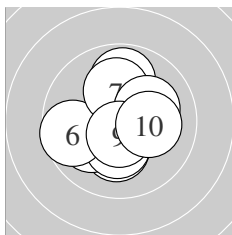
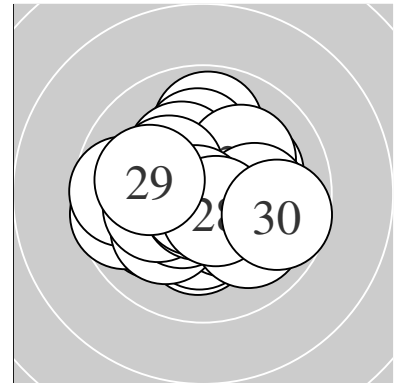

Serie 1:
 10.6 * 10.2 * 10.0 ↙ 10.3 * 9.9 ↑
 9.6 ← 10.1 ↑ 10.1 → 10.6 * 10.2 *
 beste Teiler 89.0 (9.) 99.0 (1.) 165.6 (4.)
 Trefferlage 0.16 mm links, 0.00 mm
 Streuwert 1.56, horizontal: 1.53, vertikal: 1.59

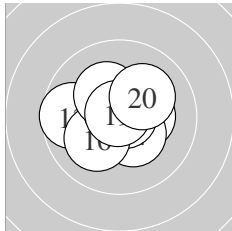

Serie 2:
 10.3 * 10.2 * 9.7 ← 10.4 * 10.8 *
 10.1 ↙ 10.7 * 10.3 * 10.8 * 10.1 ↗
 beste Teiler 27.7 (19.) 32.8 (15.) 66.3 (17.)
 Trefferlage 0.34 mm links, 0.19 mm hoch
 Streuwert 1.27, horizontal: 1.53, vertikal: 0.93

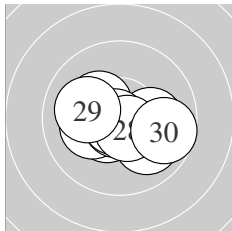

Serie 3:
 10.5 * 10.0 ↘ 10.2 * 10.3 * 10.1 →
 10.8 * 10.8 * 10.6 * 10.1 ← 9.7 →
 beste Teiler 41.2 (27.) 49.2 (26.) 87.2 (28.)
 Trefferlage 0.06 mm rechts, 0.38 mm tief
 Streuwert 1.35, horizontal: 1.76, vertikal: 0.72

Unterschrift des Schützen

Ergebnis: **303.5** (288)
 Serien: 100.4 102.2 100.9
 Zähler: 18 12 0 0 0 0 0 0 0 0
 Innenzehner: 14
 weiteste: 392 (1), 386 (3), 365 (12)
 beste Teiler 15.0 (29.) 62.1 (13.) 64.2 (15.)
 Trefferlage 0.12 mm links, 0.49 mm tief
 Streuwert 1.64, horizontal: 1.89, vertikal: 1.34

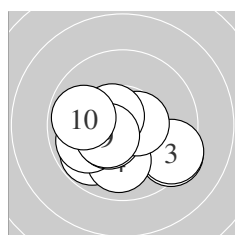
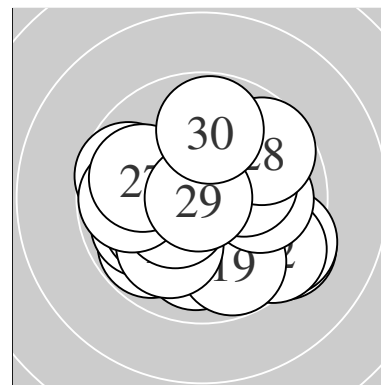

Serie 1:
 9.4 ↘ 9.8 ↙ 9.4 ↘ 10.0 ↓ 9.9 ↙
 10.5 * 10.6 * 10.6 * 10.4 * 9.8 ←
 beste Teiler 96.4 (8.) 100.6 (7.) 124.8 (6.)
 Trefferlage 0.24 mm links, 0.95 mm tief
 Streuwert 1.74, horizontal: 2.20, vertikal: 1.11

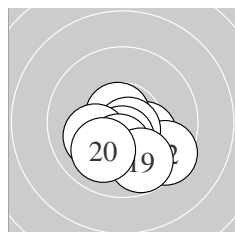

Serie 2:
 10.3 * 9.5 ↘ 10.7 * 10.3 * 10.7 *
 10.5 * 10.1 ↙ 10.3 * 9.8 ↘ 10.0 ↙
 beste Teiler 62.1 (13.) 64.2 (15.) 112.0 (16.)
 Trefferlage 0.12 mm rechts, 1.27 mm tief
 Streuwert 1.22, horizontal: 1.46, vertikal: 0.91

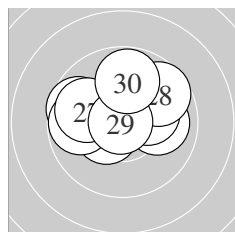

Serie 3:
 10.0 → 10.4 * 9.7 ↖ 10.5 * 10.2 *
 9.8 ← 9.9 ↖ 9.7 ↗ 10.9 * 9.8 ↑
 beste Teiler 15.0 (29.) 120.4 (24.) 131.5 (22.)
 Trefferlage 0.26 mm links, 0.76 mm hoch
 Streuwert 1.67, horizontal: 2.11, vertikal: 1.05

Unterschrift des Schützen

Meyton Elektronik

Ergebnis: **298.4** (283)
 Serien: 103.2 97.6 97.6
 Zähler: 14 15 1 0 0 0 0 0 0 0
 Innenzehner: 11
 weiteste: 520 (7), 424 (21), 418 (14)
 beste Teiler 24.1 (1.) 39.6 (3.) 68.9 (6.)
 Trefferlage 0.00 mm , 0.59 mm hoch
 Streuwert 2.02, horizontal: 2.44, vertikal: 1.47

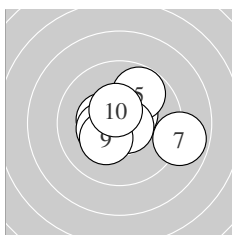
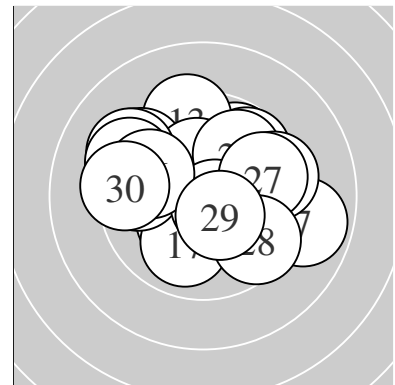

Serie 1:
 10.9 * 10.4 * 10.8 * 10.5 * 9.8 ↗
 10.7 * 8.9 ↘ 10.4 * 10.3 * 10.5 *
 beste Teiler 24.1 (1.) 39.6 (3.) 68.9 (6.)
 Trefferlage 0.44 mm rechts, 0.09 mm hoch
 Streuwert 1.57, horizontal: 1.91, vertikal: 1.13

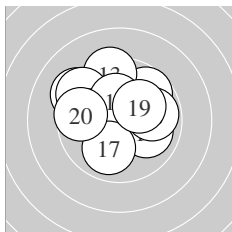

Serie 2:
 9.7 ↗ 10.0 ↘ 9.4 ↑ 9.3 ↖ 9.4 ↖
 10.3 * 10.0 ↓ 9.8 → 10.1 ↗ 9.6 ←
 beste Teiler 172.0 (16.) 201.6 (19.) 243.0 (12.)
 Trefferlage 0.31 mm links, 1.10 mm hoch
 Streuwert 2.14, horizontal: 2.45, vertikal: 1.77

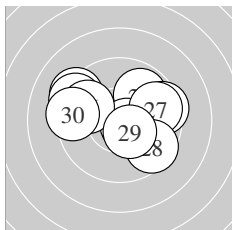

Serie 3:
 9.3 ↖ 9.9 ↗ 10.7 * 9.3 ↖ 9.5 →
 9.8 ↖ 9.7 → 9.6 ↘ 10.4 * 9.4 ←
 beste Teiler 72.6 (23.) 130.3 (29.) 272.0 (22.)
 Trefferlage 0.15 mm links, 0.59 mm hoch
 Streuwert 2.37, horizontal: 3.04, vertikal: 1.41

Unterschrift des Schützen

Ergebnis: **307.6** (295)
 Serien: 101.1 103.2 103.3
 Zähler: 25 5 0 0 0 0 0 0 0 0
 Innenzehner: 18
 weiteste: 413 (26), 385 (16), 336 (6)
 beste Teiler 19.4 (28.) 27.6 (13.) 45.5 (29.)
 Trefferlage 0.24 mm rechts, 0.27 mm hoch
 Streuwert 1.43, horizontal: 1.52, vertikal: 1.35

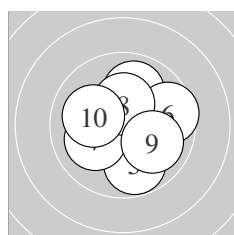
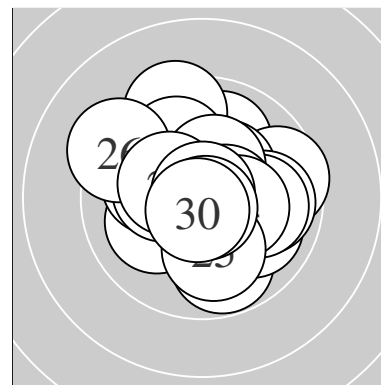

Serie 1:
 10.3 * 10.0 ↑ 10.5 * 10.4 * 9.8 ↓
 9.6 → 10.1 ← 10.3 * 10.0 ↘ 10.1 ←
 beste Teiler 111.2 (3.) 127.3 (4.) 153.1 (8.)
 Trefferlage 0.58 mm rechts, 0.14 mm tief
 Streuwert 1.60, horizontal: 1.69, vertikal: 1.51

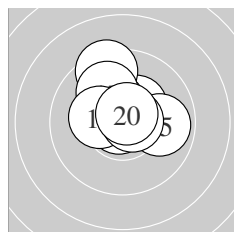

Serie 2:
 10.6 * 10.4 * 10.8 * 10.4 * 9.9 →
 9.4 ↑ 10.0 ↘ 10.3 * 10.7 * 10.7 *
 beste Teiler 27.6 (13.) 67.0 (20.) 70.5 (19.)
 Trefferlage 0.07 mm rechts, 0.93 mm hoch
 Streuwert 1.26, horizontal: 1.30, vertikal: 1.21

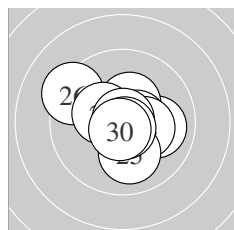

Serie 3:
 10.0 → 10.4 * 10.6 * 10.3 * 10.0 ↓
 9.3 ↘ 10.3 * 10.9 * 10.8 * 10.7 *
 beste Teiler 19.4 (28.) 45.5 (29.) 56.6 (30.)
 Trefferlage 0.08 mm rechts, 0.03 mm hoch
 Streuwert 1.42, horizontal: 1.64, vertikal: 1.16

Unterschrift des Schützen

Meyton Elektronik

Ergebnis: **310.8** (298)
 Serien: 102.7 104.1 104.0
 Zähler: 28 2 0 0 0 0 0 0 0 0
 Innenzehner: 23
 weiteste: 305 (6), 254 (14), 247 (5)
 beste Teiler 25.5 (21.) 49.4 (7.) 50.5 (15.)
 Trefferlage 0.51 mm rechts, 0.10 mm tief
 Streuwert 1.11, horizontal: 1.22, vertikal: 0.99

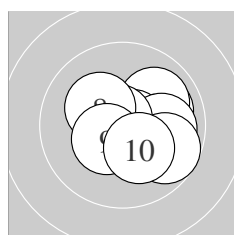
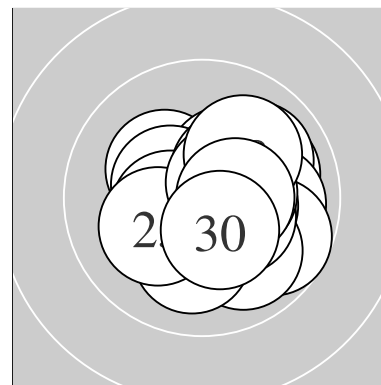

Serie 1:
 10.0 → 10.7 * 10.0 ↗ 10.7 * 10.0 →
 9.7 ↘ 10.8 * 10.2 * 10.4 * 10.2 *
 beste Teiler 49.4 (7.) 59.0 (4.) 62.1 (2.)
 Trefferlage 0.87 mm rechts, 0.01 mm hoch
 Streuwert 1.26, horizontal: 1.47, vertikal: 1.02

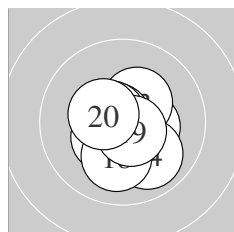

Serie 2:
 10.6 * 10.4 * 10.3 * 9.9 ↘ 10.8 *
 10.4 * 10.6 * 10.1 ↓ 10.6 * 10.4 *
 beste Teiler 50.5 (15.) 76.3 (19.) 84.8 (11.)
 Trefferlage 0.12 mm rechts, 0.31 mm tief
 Streuwert 1.06, horizontal: 1.02, vertikal: 1.11

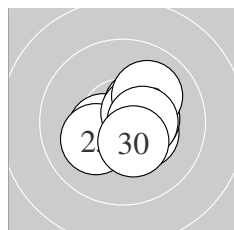

Serie 3:
 10.9 * 10.4 * 10.4 * 10.4 * 10.2 *
 10.5 * 10.4 * 10.0 ↗ 10.4 * 10.4 *
 beste Teiler 25.5 (21.) 105.1 (26.) 126.0 (29.)
 Trefferlage 0.53 mm rechts, 0.01 mm tief
 Streuwert 1.03, horizontal: 1.13, vertikal: 0.92

Unterschrift des Schützen

Meyton Elektronik

Ergebnis: **289.8** (275)
 Serien: 98.0 97.7 94.1
 Zähler: 11 13 6 0 0 0 0 0 0 0
 Innenzehner: 6
 weiteste: 638 (22), 582 (28), 545 (10)
 beste Teiler 50.6 (15.) 87.7 (12.) 118.1 (17.)
 Trefferlage 0.65 mm links, 1.07 mm tief
 Streuwert 2.40, horizontal: 2.78, vertikal: 1.95

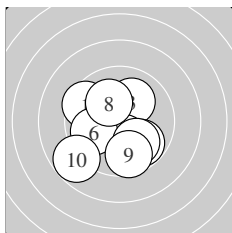
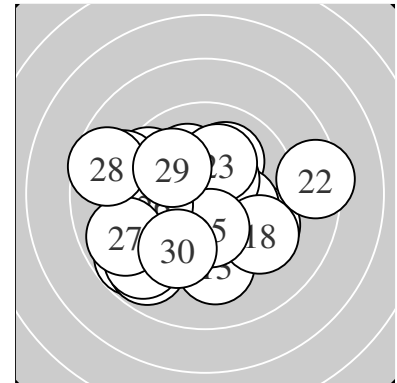

Serie 1:
 9.5 ↘ 10.0 ↘ 10.1 ↗ 10.3 * 9.8 ↘
 9.9 ↙ 9.9 ↘ 10.1 ↘ 9.6 ↓ 8.8 ↙
 beste Teiler 166.1 (4.) 203.7 (8.) 219.5 (3.)
 Trefferlage 0.34 mm links, 1.03 mm tief
 Streuwert 2.13, horizontal: 2.21, vertikal: 2.05

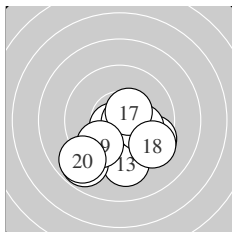

Serie 2:
 9.5 ↘ 10.6 * 9.3 ↓ 8.8 ✓ 10.8 *
 10.1 → 10.5 * 9.4 ↘ 9.8 ✓ 8.9 ✓
 beste Teiler 50.6 (15.) 87.7 (12.) 118.1 (17.)
 Trefferlage 0.08 mm rechts, 1.89 mm tief
 Streuwert 2.10, horizontal: 2.42, vertikal: 1.73

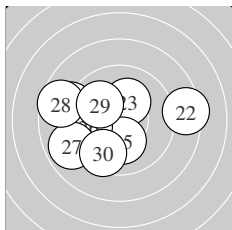

Serie 3:
 9.0 ↘ 8.4 → 10.2 * 9.5 ↙ 10.2 *
 9.8 ↙ 8.9 ↙ 8.6 ↙ 10.0 ↘ 9.5 ↙
 beste Teiler 189.6 (23.) 198.2 (25.) 240.5 (29.)
 Trefferlage 1.69 mm links, 0.29 mm tief
 Streuwert 2.82, horizontal: 3.50, vertikal: 1.92

Unterschrift des Schützen

Ergebnis: **300.8** (287)
 Serien: 98.3 98.9 103.6
 Zähler: 18 11 1 0 0 0 0 0 0 0
 Innenzehner: 12
 weiteste: 598 (1), 474 (11), 447 (5)
 beste Teiler 15.5 (27.) 72.4 (28.) 78.0 (21.)
 Trefferlage 0.81 mm rechts, 0.35 mm hoch
 Streuwert 1.81, horizontal: 2.11, vertikal: 1.45

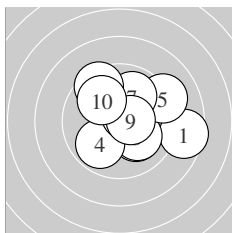
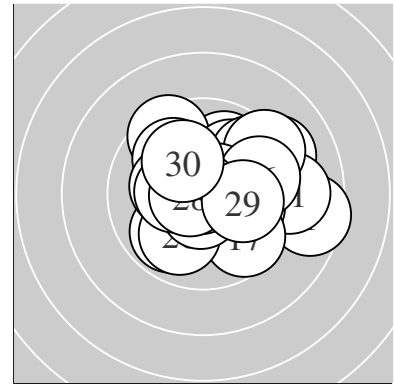

Serie 1:
 8.6 → 10.1 ↘ 10.1 ↘ 9.9 ↙ 9.2 ↗
 10.6 * 9.9 ↗ 9.5 ↘ 10.5 * 9.9 ↘
 beste Teiler 79.2 (6.) 101.4 (9.) 207.2 (2.)
 Trefferlage 1.03 mm rechts, 0.40 mm hoch
 Streuwert 2.21, horizontal: 2.50, vertikal: 1.87

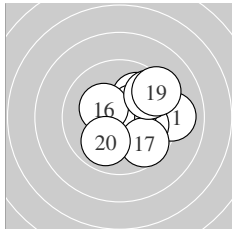

Serie 2:
 9.1 → 10.0 → 10.0 ↗ 10.4 * 10.6 *
 10.3 * 9.7 ↘ 9.6 ↗ 9.3 ↗ 9.9 ↙
 beste Teiler 87.2 (15.) 148.0 (14.) 167.5 (16.)
 Trefferlage 1.44 mm rechts, 0.27 mm hoch
 Streuwert 1.87, horizontal: 2.07, vertikal: 1.64

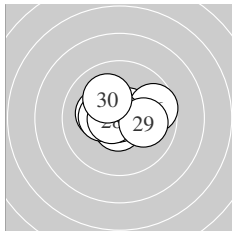

Serie 3:
 10.6 * 10.6 * 10.4 * 10.2 * 10.3 *
 9.7 → 10.9 * 10.7 * 10.1 → 10.1 ↘
 beste Teiler 15.5 (27.) 72.4 (28.) 78.0 (21.)
 Trefferlage 0.03 mm links, 0.36 mm hoch
 Streuwert 1.25, horizontal: 1.60, vertikal: 0.76

Unterschrift des Schützen

Ergebnis: **304.8** (292)
 Serien: 100.2 104.1 100.5
 Zähler: 22 8 0 0 0 0 0 0 0 0
 Innenzehner: 14
 weiteste: 449 (7), 404 (25), 399 (6)
 beste Teiler 9.0 (18.) 37.9 (11.) 46.0 (20.)
 Trefferlage 0.63 mm links, 0.48 mm tief
 Streuwert 1.55, horizontal: 1.58, vertikal: 1.52

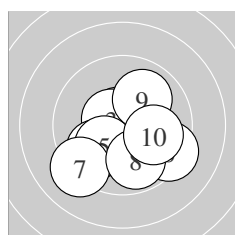
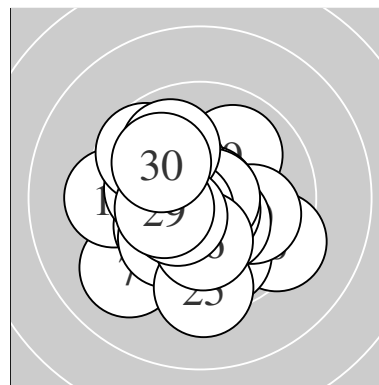

Serie 1:
 10.4 * 10.7 * 10.6 * 9.9 ↙ 10.1 ↘
 9.4 ↘ 9.2 ↙ 9.9 ↓ 10.0 ↗ 10.0 →
 beste Teiler 69.3 (2.) 97.1 (3.) 141.0 (1.)
 Trefferlage 0.05 mm rechts, 1.01 mm tief
 Streuwert 1.83, horizontal: 2.04, vertikal: 1.59

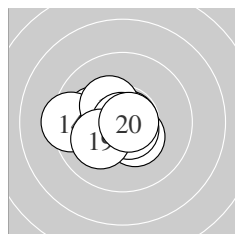

Serie 2:
 10.8 * 10.4 * 10.1 ← 9.4 ← 10.6 *
 10.3 * 10.7 * 10.9 * 10.1 ↙ 10.8 *
 beste Teiler 9.0 (18.) 37.9 (11.) 46.0 (20.)
 Trefferlage 0.74 mm links, 0.10 mm tief
 Streuwert 1.18, horizontal: 1.50, vertikal: 0.73

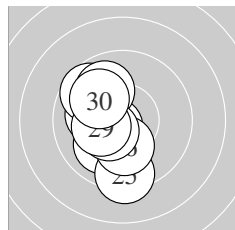

Serie 3:
 10.1 ← 10.6 * 10.0 ↙ 9.7 ↘ 9.3 ↓
 10.2 * 9.9 ↘ 10.4 * 10.3 * 10.0 ↘
 beste Teiler 89.4 (22.) 130.0 (28.) 167.7 (29.)
 Trefferlage 1.21 mm links, 0.33 mm tief
 Streuwert 1.53, horizontal: 0.87, vertikal: 1.98

Unterschrift des Schützen

Meyton Elektronik

Ergebnis: **303.9** (290)
 Serien: 102.8 101.1 100.0
 Zähler: 22 6 2 0 0 0 0 0 0 0
 Innenzehner: 20
 weiteste: 607 (25), 529 (8), 405 (24)
 beste Teiler 33.0 (6.) 40.5 (14.) 94.4 (11.)
 Trefferlage 0.69 mm rechts, 0.78 mm tief
 Streuwert 1.61, horizontal: 1.93, vertikal: 1.21

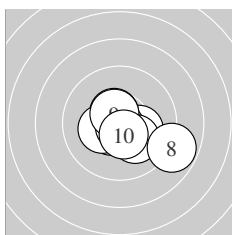
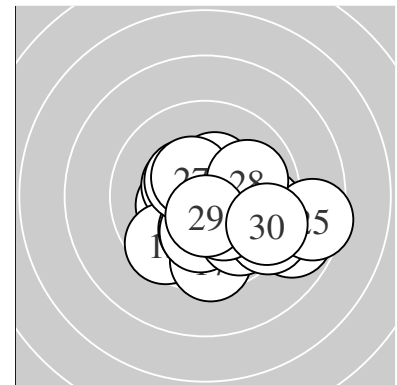

Serie 1:
 10.2 * 10.5 * 10.5 * 10.5 * 10.3 *
 10.8 * 10.1 ↘ 8.8 ↘ 10.6 * 10.5 *
 beste Teiler 33.0 (6.) 99.3 (9.) 104.0 (2.)
 Trefferlage 0.40 mm rechts, 0.55 mm tief
 Streuwert 1.48, horizontal: 1.86, vertikal: 0.96

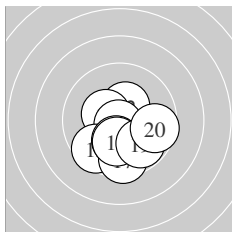

Serie 2:
 10.6 * 10.4 * 10.4 * 10.8 * 9.6 ↙
 10.2 * 9.5 ↓ 10.2 * 9.8 ↘ 9.6 →
 beste Teiler 40.5 (14.) 94.4 (11.) 137.6 (12.)
 Trefferlage 0.10 mm rechts, 1.20 mm tief
 Streuwert 1.52, horizontal: 1.54, vertikal: 1.49

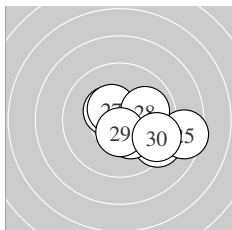

Serie 3:
 10.6 * 10.4 * 10.5 * 9.3 ↘ 8.5 →
 10.3 * 10.4 * 10.0 → 10.5 * 9.5 ↘
 beste Teiler 99.9 (21.) 105.8 (23.) 111.1 (29.)
 Trefferlage 1.57 mm rechts, 0.60 mm tief
 Streuwert 1.75, horizontal: 2.20, vertikal: 1.12

Unterschrift des Schützen

Ergebnis: **287.2** (275)
 Serien: 92.4 96.7 98.1
 Zähler: 11 16 2 0 0 1 0 0 0 0
 Innenzehner: 6
 weiteste: 1430 (9), 590 (17), 562 (13)
 beste Teiler 52.4 (20.) 93.8 (15.) 132.4 (19.)
 Trefferlage 0.52 mm rechts, 0.85 mm tief
 Streuwert 2.94, horizontal: 2.85, vertikal: 3.03

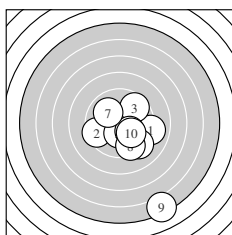
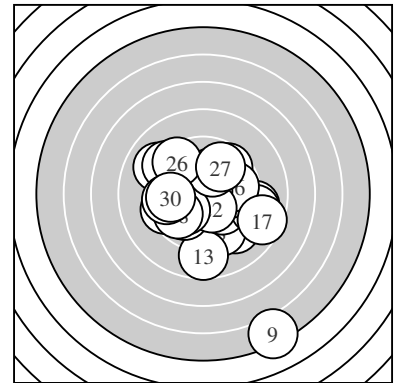

Serie 1:
 9.0 → 9.5 ← 9.6 ↗ 9.2 ↘ 10.3 *
 10.2 * 10.0 ↖ 9.4 ↘ 5.2 ↘ 10.0 ↘
 beste Teiler 152.8 (5.) 194.4 (6.) 228.5 (10.)
 Trefferlage 1.58 mm rechts, 2.20 mm tief
 Streuwert 3.57, horizontal: 2.89, vertikal: 4.14

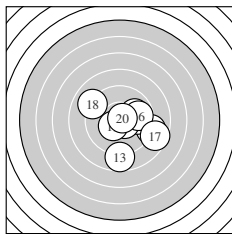

Serie 2:
 9.0 → 10.0 ↗ 8.7 ↓ 9.9 → 10.6 *
 9.8 → 8.6 ↘ 9.0 ↖ 10.4 * 10.7 *
 beste Teiler 52.4 (20.) 93.8 (15.) 132.4 (19.)
 Trefferlage 1.41 mm rechts, 0.63 mm tief
 Streuwert 2.53, horizontal: 2.82, vertikal: 2.21

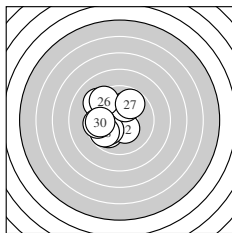

Serie 3:
 9.9 ↖ 10.3 * 9.3 ↖ 10.1 ↖ 10.1 ↗
 9.4 ↖ 9.8 ↗ 9.8 ↖ 9.6 ← 9.8 ←
 beste Teiler 152.0 (22.) 217.7 (25.) 219.3 (24.)
 Trefferlage 1.42 mm links, 0.26 mm hoch
 Streuwert 1.93, horizontal: 1.85, vertikal: 2.00

Unterschrift des Schützen

Ergebnis: **289.7** (276)
 Serien: 96.2 97.0 96.5
 Zähler: 9 18 3 0 0 0 0 0 0 0
 Innenzehner: 6
 weiteste: 714 (21), 573 (6), 523 (18)
 beste Teiler 60.1 (13.) 107.2 (7.) 140.4 (16.)
 Trefferlage 0.64 mm rechts, 1.29 mm tief
 Streuwert 2.33, horizontal: 2.81, vertikal: 1.71

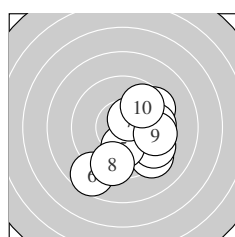
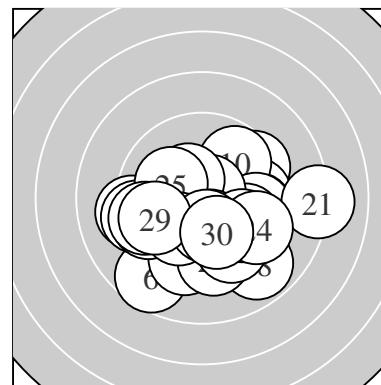

Serie 1:
 9.5 ↗ 9.7 → 9.3 ↘ 9.5 ↘ 10.2 *
 8.7 ↙ 10.5 * 9.4 ↓ 9.6 → 9.8 ↗
 beste Teiler 107.2 (7.) 200.0 (5.) 296.5 (10.)
 Trefferlage 1.45 mm rechts, 1.10 mm tief
 Streuwert 2.31, horizontal: 2.24, vertikal: 2.38

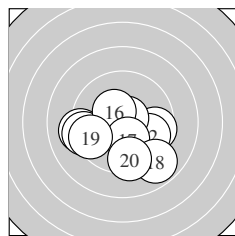

Serie 2:
 9.6 → 9.8 ↘ 10.7 * 9.2 ← 9.3 ←
 10.4 * 10.2 * 8.9 ↘ 9.5 ← 9.4 ↓
 beste Teiler 60.1 (13.) 140.4 (16.) 180.6 (17.)
 Trefferlage 0.14 mm links, 1.36 mm tief
 Streuwert 2.35, horizontal: 2.91, vertikal: 1.60

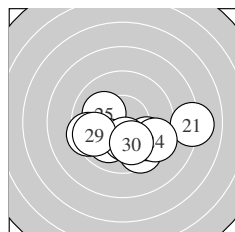

Serie 3:
 8.1 → 9.6 ↘ 9.8 ↘ 9.4 ↘ 10.1 ↘
 10.0 ↙ 10.3 * 9.5 ← 9.7 ← 10.0 ↓
 beste Teiler 175.9 (27.) 209.8 (25.) 230.3 (30.)
 Trefferlage 0.61 mm rechts, 1.41 mm tief
 Streuwert 2.42, horizontal: 3.25, vertikal: 1.07

Unterschrift des Schützen

Meyton Elektronik

Ergebnis: **291.7** (278)
 Serien: 96.1 99.2 96.4
 Zähler: 12 14 4 0 0 0 0 0 0 0
 Innenzehner: 7
 weiteste: 628 (27), 596 (6), 568 (1)
 beste Teiler 91.7 (9.) 103.0 (22.) 113.3 (14.)
 Trefferlage 1.66 mm rechts, 0.64 mm hoch
 Streuwert 2.11, horizontal: 2.18, vertikal: 2.03

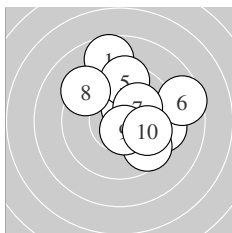
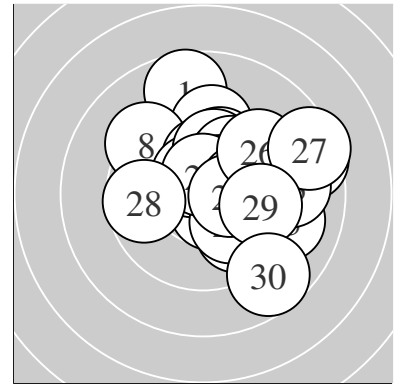

Serie 1:
 8.7 ↑ 10.4 * 9.4 → 9.6 ↘ 9.5 ↑
 8.6 → 10.1 ↗ 9.3 ↖ 10.6 * 9.9 →

beste Teiler 91.7 (9.) 136.0 (2.) 205.0 (7.)
 Trefferlage 1.35 mm rechts, 1.18 mm hoch
 Streuwert 2.43, horizontal: 2.47, vertikal: 2.40

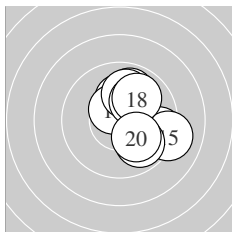

Serie 2:
 9.9 ↑ 9.5 → 10.2 * 10.5 * 9.1 →
 10.0 ↑ 10.1 ↗ 9.9 ↗ 9.9 ↘ 10.1 ↘

beste Teiler 113.3 (14.) 193.0 (13.) 213.4 (17.)
 Trefferlage 1.50 mm rechts, 0.54 mm hoch
 Streuwert 1.67, horizontal: 1.51, vertikal: 1.82

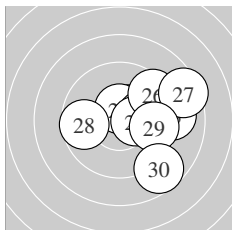

Serie 3:
 10.4 * 10.5 * 9.1 → 10.1 → 10.4 *
 9.4 ↗ 8.4 → 9.7 ← 9.7 → 8.7 ↘

beste Teiler 103.0 (22.) 129.4 (21.) 145.2 (25.)
 Trefferlage 2.13 mm rechts, 0.22 mm hoch
 Streuwert 2.26, horizontal: 2.56, vertikal: 1.93

Unterschrift des Schützen

Ergebnis: **307.3** (296)
 Serien: 101.6 102.8 102.9
 Zähler: 26 4 0 0 0 0 0 0 0 0
 Innenzehner: 19
 weiteste: 346 (5), 325 (4), 283 (1)
 beste Teiler 27.0 (27.) 80.7 (2.) 84.5 (16.)
 Trefferlage 0.19 mm links, 0.02 mm hoch
 Streuwert 1.37, horizontal: 1.63, vertikal: 1.06

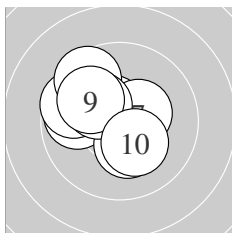
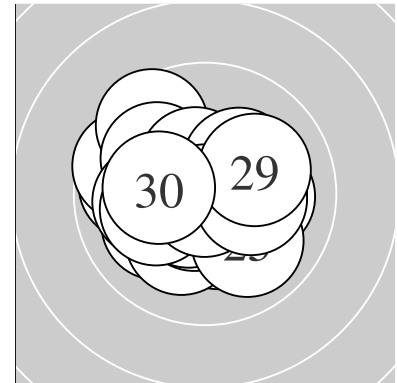

Serie 1:
 9.8 ← 10.6 * 10.6 * 9.7 ↖ 9.6 ↗
 10.3 * 10.4 * 10.3 * 10.0 ↗ 10.3 *
 beste Teiler 80.7 (2.) 96.5 (3.) 137.0 (7.)
 Trefferlage 0.82 mm links, 0.49 mm hoch
 Streuwert 1.48, horizontal: 1.65, vertikal: 1.29

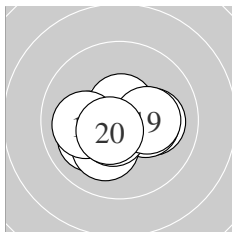

Serie 2:
 10.1 → 10.2 * 10.3 * 10.1 ↙ 10.1 ↘
 10.6 * 10.6 * 10.0 ← 10.2 * 10.6 *
 beste Teiler 84.5 (16.) 93.4 (17.) 96.2 (20.)
 Trefferlage 0.23 mm links, 0.46 mm tief
 Streuwert 1.27, horizontal: 1.65, vertikal: 0.72

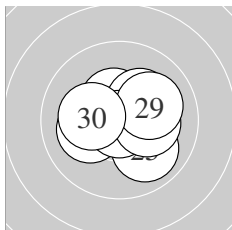

Serie 3:
 10.4 * 10.1 ← 10.4 * 10.6 * 9.9 ↘
 10.2 * 10.8 * 10.2 * 10.1 → 10.2 *
 beste Teiler 27.0 (27.) 85.2 (24.) 128.0 (21.)
 Trefferlage 0.47 mm rechts, 0.05 mm hoch
 Streuwert 1.24, horizontal: 1.47, vertikal: 0.96

Unterschrift des Schützen

Ergebnis: **310.6** (296)
 Serien: 102.4 103.5 104.7
 Zähler: 26 4 0 0 0 0 0 0 0 0
 Innenzehner: 23
 weiteste: 317 (7), 287 (3), 279 (18)
 beste Teiler 15.1 (25.) 23.4 (17.) 50.7 (27.)
 Trefferlage 0.37 mm links, 0.19 mm tief
 Streuwert 1.18, horizontal: 1.34, vertikal: 0.98

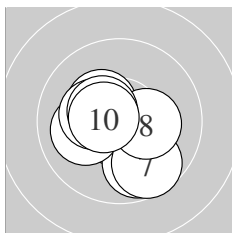
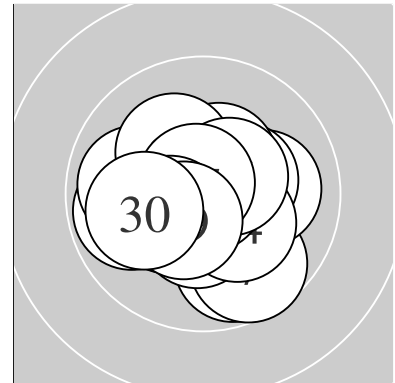

Serie 1:
 10.7 * 10.3 * 9.8 ↘ 10.1 ← 10.3 *
 10.3 * 9.7 ↘ 10.3 * 10.4 * 10.5 *
 beste Teiler 69.4 (1.) 103.8 (10.) 127.2 (9.)
 Trefferlage 0.46 mm links, 0.44 mm tief
 Streuwert 1.36, horizontal: 1.45, vertikal: 1.27

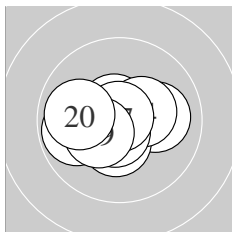

Serie 2:
 10.0 → 10.6 * 10.4 * 10.4 * 10.6 *
 10.6 * 10.9 * 9.8 ← 10.3 * 9.9 ←
 beste Teiler 23.4 (17.) 77.3 (12.) 79.4 (15.)
 Trefferlage 0.46 mm links, 0.17 mm tief
 Streuwert 1.19, horizontal: 1.54, vertikal: 0.68

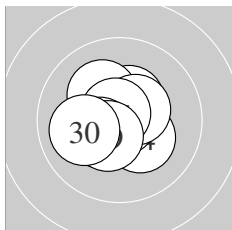

Serie 3:
 10.7 * 10.4 * 10.2 * 10.3 * 10.9 *
 10.5 * 10.8 * 10.4 * 10.5 * 10.0 ←
 beste Teiler 15.1 (25.) 50.7 (27.) 70.6 (21.)
 Trefferlage 0.18 mm links, 0.01 mm hoch
 Streuwert 1.04, horizontal: 1.14, vertikal: 0.94

 Unterschrift des Schützen

Ergebnis: **300.3** (287)
 Serien: 99.3 99.3 101.7
 Zähler: 18 11 1 0 0 0 0 0 0 0
 Innenzehner: 14
 weiteste: 534 (20), 414 (18), 374 (7)
 beste Teiler 7.0 (25.) 86.3 (11.) 113.8 (15.)
 Trefferlage 0.82 mm rechts, 0.72 mm tief
 Streuwert 1.71, horizontal: 1.71, vertikal: 1.71

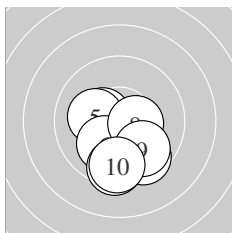
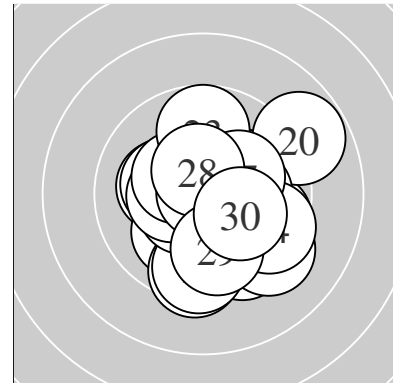

Serie 1:
 10.2 * 10.4 * 9.6 ↘ 9.6 ↘ 10.2 *
 10.1 ↗ 9.5 ↓ 10.4 * 9.8 ↘ 9.5 ↓
 beste Teiler 130.3 (8.) 142.9 (2.) 187.4 (1.)
 Trefferlage 0.25 mm rechts, 1.80 mm tief
 Streuwert 1.50, horizontal: 1.47, vertikal: 1.54

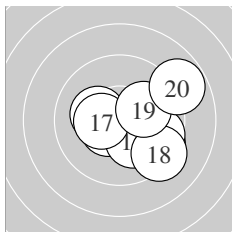

Serie 2:
 10.6 * 9.5 ↘ 10.2 * 9.7 ↘ 10.5 *
 10.2 * 10.4 * 9.3 ↘ 10.1 ↗ 8.8 ↗
 beste Teiler 86.3 (11.) 113.8 (15.) 146.2 (17.)
 Trefferlage 1.29 mm rechts, 0.49 mm tief
 Streuwert 1.91, horizontal: 2.21, vertikal: 1.55

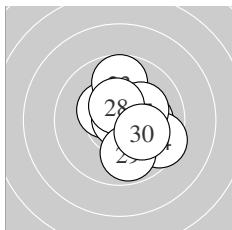

Serie 3:
 10.1 → 10.4 * 9.7 ↑ 9.5 ↘ 10.9 *
 10.4 * 10.2 * 10.5 * 9.9 ↓ 10.1 ↘
 beste Teiler 7.0 (25.) 116.7 (28.) 144.9 (26.)
 Trefferlage 0.93 mm rechts, 0.12 mm hoch
 Streuwert 1.46, horizontal: 1.32, vertikal: 1.58

Unterschrift des Schützen

Ergebnis: **307.6** (292)
 Serien: 101.5 102.7 103.4
 Zähler: 23 6 1 0 0 0 0 0 0 0
 Innenzehner: 21
 weiteste: 586 (6), 350 (12), 337 (1)
 beste Teiler 30.8 (20.) 41.0 (2.) 47.3 (27.)
 Trefferlage 1.00 mm links, 0.60 mm tief
 Streuwert 1.24, horizontal: 1.39, vertikal: 1.06

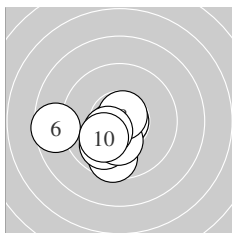
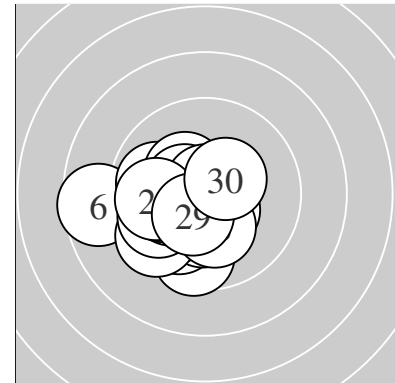

Serie 1:
 9.6 ↓ 10.8 * 9.9 ↙ 10.7 * 10.5 *
 8.6 ← 10.2 * 10.7 * 10.4 * 10.1 ↙
 beste Teiler 41.0 (2.) 58.5 (8.) 68.5 (4.)
 Trefferlage 1.05 mm links, 1.13 mm tief
 Streuwert 1.49, horizontal: 1.79, vertikal: 1.11

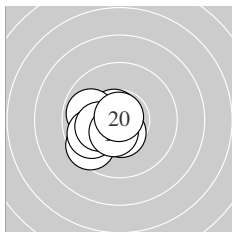

Serie 2:
 10.6 * 9.6 ↙ 10.5 * 10.3 * 10.5 *
 9.9 ← 9.8 ← 10.2 * 10.5 * 10.8 *
 beste Teiler 30.8 (20.) 76.4 (11.) 116.1 (15.)
 Trefferlage 1.30 mm links, 0.61 mm tief
 Streuwert 1.00, horizontal: 1.08, vertikal: 0.91

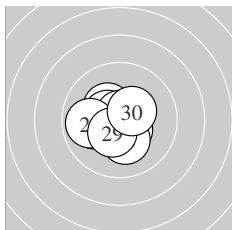

Serie 3:
 10.0 ← 10.5 * 10.2 * 10.4 * 10.3 *
 10.5 * 10.8 * 9.9 ← 10.4 * 10.4 *
 beste Teiler 47.3 (27.) 115.5 (22.) 120.5 (26.)
 Trefferlage 0.63 mm links, 0.07 mm tief
 Streuwert 1.12, horizontal: 1.26, vertikal: 0.97

Unterschrift des Schützen

Ergebnis: **284.2** (269)
 Serien: 93.0 98.1 93.1
 Zähler: 7 15 8 0 0 0 0 0 0 0
 Innenzehner: 6
 weiteste: 703 (8), 676 (6), 662 (7)
 beste Teiler 49.2 (2.) 104.0 (18.) 113.8 (17.)
 Trefferlage 0.84 mm links, 0.33 mm tief
 Streuwert 2.90, horizontal: 2.99, vertikal: 2.80

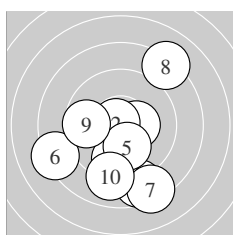
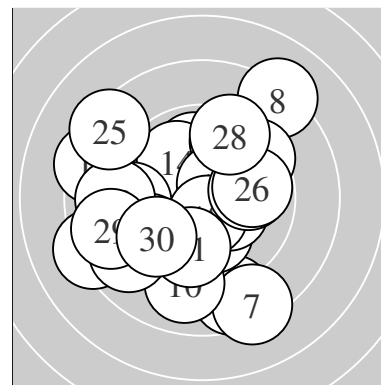

Serie 1:
 10.4 * 10.8 * 8.7 ↓ 9.7 ↓ 10.1 ↓
 8.2 ← 8.3 ↓ 8.1 ↗ 9.7 ← 9.0 ↓
 beste Teiler 49.2 (2.) 147.0 (1.) 207.1 (5.)
 Trefferlage 0.04 mm links, 1.82 mm tief
 Streuwert 3.24, horizontal: 2.99, vertikal: 3.48

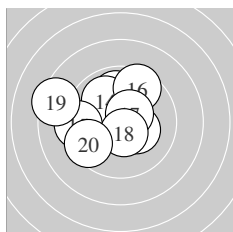

Serie 2:
 10.3 * 9.9 ↑ 10.2 * 9.9 ↖ 9.4 ←
 9.5 ↗ 10.5 * 10.5 * 8.4 ↖ 9.5 ←
 beste Teiler 104.0 (18.) 113.8 (17.) 165.4 (11.)
 Trefferlage 1.24 mm links, 0.74 mm hoch
 Streuwert 2.15, horizontal: 2.51, vertikal: 1.70

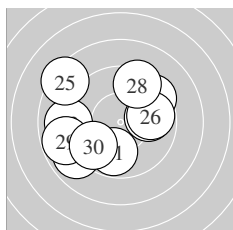

Serie 3:
 9.8 ↓ 9.0 ← 9.9 → 9.5 ↗ 8.4 ↖
 9.8 → 8.9 ↖ 9.4 ↑ 8.8 ← 9.6 ←
 beste Teiler 263.6 (23.) 284.5 (21.) 288.5 (26.)
 Trefferlage 1.25 mm links, 0.08 mm hoch
 Streuwert 3.07, horizontal: 3.52, vertikal: 2.53

Unterschrift des Schützen

Meyton Elektronik

Ergebnis: **302.8** (289)
 Serien: 101.6 101.0 100.2
 Zähler: 19 11 0 0 0 0 0 0 0 0
 Innenzehner: 15
 weiteste: 432 (21), 417 (11), 347 (30)
 beste Teiler 77.4 (10.) 96.2 (2.) 97.0 (16.)
 Trefferlage 0.56 mm rechts, 0.03 mm hoch
 Streuwert 1.65, horizontal: 1.90, vertikal: 1.35

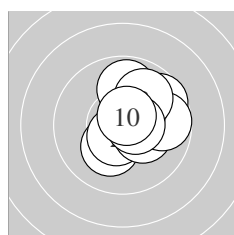
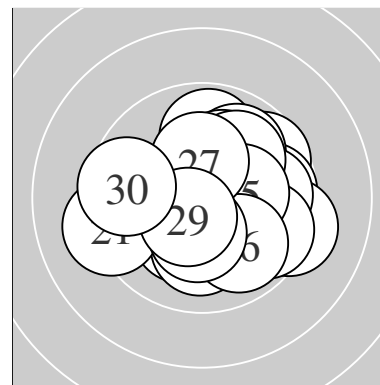

Serie 1:
 10.2 * 10.6 * 10.3 * 10.1 ↗ 9.7 ↗
 9.9 ↑ 9.7 → 9.9 ↗ 10.6 * 10.6 *
 beste Teiler 77.4 (10.) 96.2 (2.) 98.0 (9.)
 Trefferlage 1.07 mm rechts, 0.55 mm hoch
 Streuwert 1.33, horizontal: 1.29, vertikal: 1.38

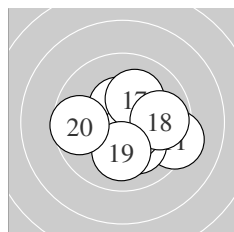

Serie 2:
 9.3 → 10.3 * 10.1 ↘ 10.5 * 10.5 *
 10.6 * 10.2 * 9.8 → 10.1 ↓ 9.6 ←
 beste Teiler 97.0 (16.) 121.6 (14.) 122.8 (15.)
 Trefferlage 0.82 mm rechts, 0.16 mm tief
 Streuwert 1.64, horizontal: 1.93, vertikal: 1.30

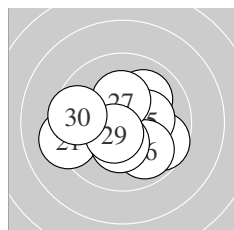

Serie 3:
 9.2 ← 9.7 → 10.4 * 10.0 ↗ 10.3 *
 9.9 ↘ 10.3 * 10.3 * 10.5 * 9.6 ←
 beste Teiler 108.6 (29.) 136.1 (23.) 161.3 (28.)
 Trefferlage 0.20 mm links, 0.29 mm tief
 Streuwert 1.88, horizontal: 2.29, vertikal: 1.36

Unterschrift des Schützen

Meyton Elektronik

Ergebnis: **308.9** (295)
 Serien: 103.7 102.4 102.8
 Zähler: 25 5 0 0 0 0 0 0 0 0
 Innenzehner: 20
 weiteste: 315 (21), 303 (6), 270 (17)
 beste Teiler 25.4 (26.) 39.9 (1.) 72.1 (5.)
 Trefferlage 0.10 mm rechts, 0.14 mm hoch
 Streuwert 1.29, horizontal: 1.50, vertikal: 1.02

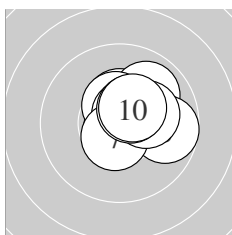
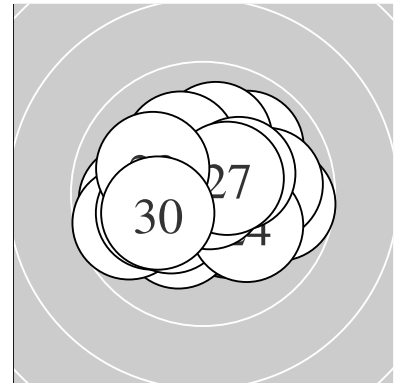

Serie 1:
 10.8 * 10.4 * 9.9 ↗ 10.5 * 10.7 *
 9.7 → 10.6 * 10.2 * 10.5 * 10.4 *
 beste Teiler 39.9 (1.) 72.1 (5.) 94.2 (7.)
 Trefferlage 0.77 mm rechts, 0.58 mm hoch
 Streuwert 0.99, horizontal: 1.09, vertikal: 0.88

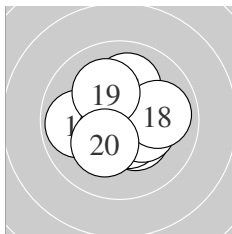

Serie 2:
 10.3 * 10.5 * 10.5 * 10.1 ↑ 10.6 *
 10.3 * 9.9 ← 9.9 → 10.1 ↘ 10.2 *
 beste Teiler 82.7 (15.) 111.1 (12.) 123.8 (13.)
 Trefferlage 0.20 mm rechts, 0.12 mm hoch
 Streuwert 1.37, horizontal: 1.50, vertikal: 1.23

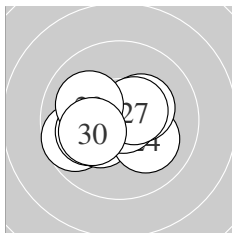

Serie 3:
 9.7 ← 10.6 * 10.3 * 10.1 ↘ 10.3 *
 10.9 * 10.5 * 10.1 ← 10.1 ↖ 10.2 *
 beste Teiler 25.4 (26.) 91.7 (22.) 114.2 (27.)
 Trefferlage 0.65 mm links, 0.26 mm tief
 Streuwert 1.30, horizontal: 1.63, vertikal: 0.84

Unterschrift des Schützen

Ergebnis: **300.4** (289)
 Serien: 99.6 100.8 100.0
 Zähler: 19 11 0 0 0 0 0 0 0 0
 Innenzehner: 14
 weiteste: 494 (1), 389 (24), 382 (16)
 beste Teiler 40.7 (22.) 82.9 (20.) 148.9 (18.)
 Trefferlage 1.29 mm links, 0.55 mm tief
 Streuwert 1.51, horizontal: 1.45, vertikal: 1.57

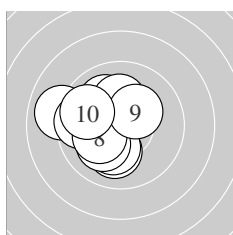
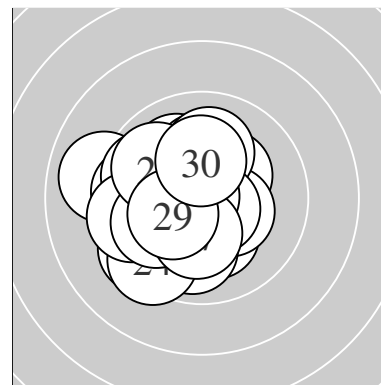

Serie 1:
 9.0 ← 10.1 ↓ 10.0 ↖ 10.2 * 9.7 ←
 10.2 * 10.1 ↙ 10.2 * 10.3 * 9.8 ←
 beste Teiler 166.3 (9.) 193.8 (4.) 195.4 (8.)
 Trefferlage 1.52 mm links, 0.09 mm hoch
 Streuwert 1.65, horizontal: 1.73, vertikal: 1.57

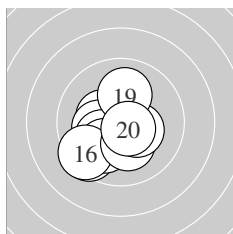

Serie 2:
 9.5 ↘ 10.3 * 10.2 * 10.2 * 10.0 ↘
 9.4 ↘ 10.2 * 10.4 * 10.0 ↑ 10.6 *
 beste Teiler 82.9 (20.) 148.9 (18.) 151.2 (12.)
 Trefferlage 0.86 mm links, 0.90 mm tief
 Streuwert 1.47, horizontal: 1.48, vertikal: 1.47

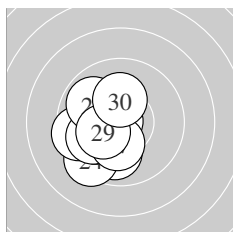

Serie 3:
 9.9 ↘ 10.8 * 9.9 ↓ 9.4 ↘ 9.5 ←
 9.9 ↘ 10.2 * 9.9 ↖ 10.3 * 10.2 *
 beste Teiler 40.7 (22.) 164.2 (29.) 176.9 (27.)
 Trefferlage 1.48 mm links, 0.87 mm tief
 Streuwert 1.39, horizontal: 1.15, vertikal: 1.60

Unterschrift des Schützen

Meyton Elektronik

Ergebnis: **287.2** (275)
 Serien: 98.4 93.5 95.3
 Zähler: 12 12 5 1 0 0 0 0 0 0
 Innenzehner: 7
 weiteste: 923 (13), 726 (10), 623 (29)
 beste Teiler 76.9 (4.) 145.0 (5.) 146.3 (12.)
 Trefferlage 1.55 mm links, 1.13 mm hoch
 Streuwert 2.47, horizontal: 2.40, vertikal: 2.53

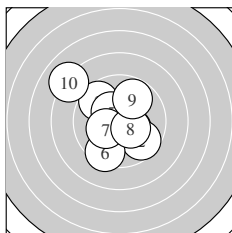
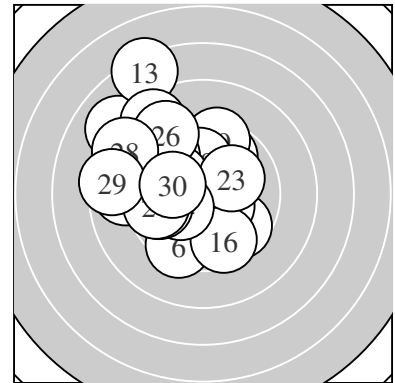

Serie 1:
 10.3 * 9.7 ↘ 9.6 ↘ 10.6 * 10.4 *
 9.4 ↙ 10.2 * 10.4 * 9.8 ↗ 8.0 ↖
 beste Teiler 76.9 (4.) 145.0 (5.) 148.4 (8.)
 Trefferlage 0.62 mm links, 0.15 mm hoch
 Streuwert 2.40, horizontal: 2.42, vertikal: 2.38

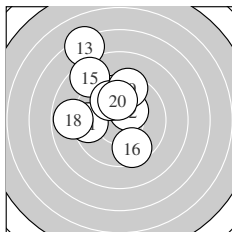

Serie 2:
 9.5 ← 10.4 * 7.3 ↖ 9.8 ↑ 8.6 ↖
 9.6 ↘ 10.0 ↖ 8.8 ← 9.5 ↑ 10.0 ↑
 beste Teiler 146.3 (12.) 226.1 (20.) 246.4 (17.)
 Trefferlage 1.44 mm links, 2.19 mm hoch
 Streuwert 2.78, horizontal: 2.40, vertikal: 3.12

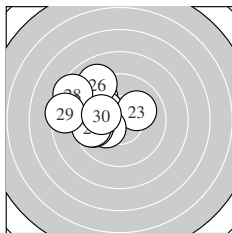

Serie 3:
 9.5 ↖ 10.1 ↖ 10.1 ↗ 10.2 * 9.7 ←
 9.0 ↖ 9.6 ← 8.5 ↖ 8.5 ← 10.1 ←
 beste Teiler 176.1 (24.) 213.0 (22.) 216.0 (30.)
 Trefferlage 2.60 mm links, 1.06 mm hoch
 Streuwert 1.96, horizontal: 2.19, vertikal: 1.70

Unterschrift des Schützen

Ergebnis: **298.6** (286)
 Serien: 100.1 99.2 99.3
 Zähler: 17 12 1 0 0 0 0 0 0 0
 Innenzehner: 10
 weiteste: 529 (18), 453 (21), 369 (10)
 beste Teiler 61.8 (2.) 72.9 (26.) 141.3 (20.)
 Trefferlage 0.48 mm links, 0.18 mm tief
 Streuwert 1.90, horizontal: 1.94, vertikal: 1.86

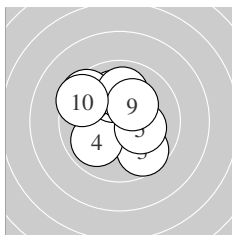
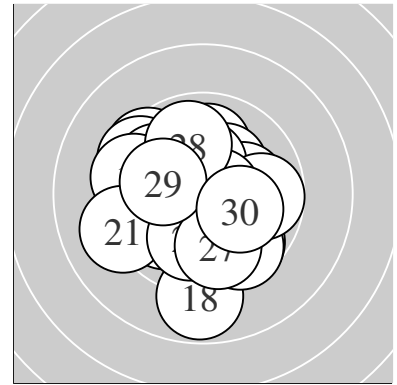

Serie 1:
 10.3 * 10.7 * 9.7 ↘ 9.9 ↙ 10.2 *
 10.1 ↑ 9.5 ↖ 10.0 ↑ 10.2 * 9.5 ↖
 beste Teiler 61.8 (2.) 161.2 (1.) 179.6 (9.)
 Trefferlage 0.55 mm links, 0.52 mm hoch
 Streuwert 1.80, horizontal: 1.85, vertikal: 1.75

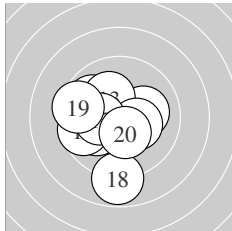

Serie 2:
 10.1 → 9.9 ↖ 10.2 * 10.1 ↙ 9.6 ←
 10.3 * 10.3 * 8.8 ↓ 9.5 ↖ 10.4 *
 beste Teiler 141.3 (20.) 158.2 (16.) 171.7 (17.)
 Trefferlage 0.98 mm links, 0.51 mm tief
 Streuwert 1.95, horizontal: 1.90, vertikal: 1.99

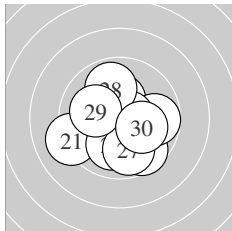

Serie 3:
 9.1 ← 9.6 ↘ 10.3 * 9.7 → 10.0 ↓
 10.7 * 9.8 ↓ 9.9 ↑ 10.1 ↖ 10.1 ↘
 beste Teiler 72.9 (26.) 157.0 (23.) 206.6 (30.)
 Trefferlage 0.07 mm rechts, 0.55 mm tief
 Streuwert 1.97, horizontal: 2.11, vertikal: 1.82

Unterschrift des Schützen

Meyton Elektronik

Ergebnis: **306.8** (295)
 Serien: 102.4 102.4 102.0
 Zähler: 25 5 0 0 0 0 0 0 0 0
 Innenzehner: 20
 weiteste: 390 (18), 335 (29), 314 (21)
 beste Teiler 52.1 (3.) 69.9 (22.) 81.3 (19.)
 Trefferlage 0.10 mm rechts, 1.02 mm tief
 Streuwert 1.21, horizontal: 1.30, vertikal: 1.11

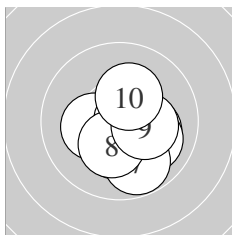
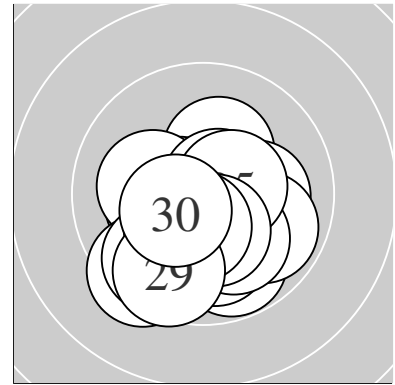

Serie 1:
 10.2 * 10.3 * 10.7 * 10.2 * 10.3 *
 10.0 ↘ 9.8 ↓ 10.3 * 10.3 * 10.3 *
 beste Teiler 52.1 (3.) 161.5 (8.) 163.9 (5.)
 Trefferlage 0.59 mm rechts, 0.84 mm tief
 Streuwert 1.18, horizontal: 1.17, vertikal: 1.20

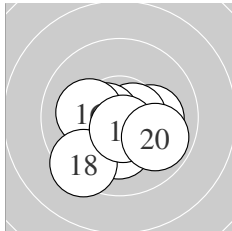

Serie 2:
 10.5 * 10.1 → 10.6 * 10.6 * 10.4 *
 10.1 ← 10.2 * 9.4 ✓ 10.6 * 9.9 ↘
 beste Teiler 81.3 (19.) 88.0 (13.) 93.0 (14.)
 Trefferlage 0.10 mm links, 0.86 mm tief
 Streuwert 1.34, horizontal: 1.58, vertikal: 1.04

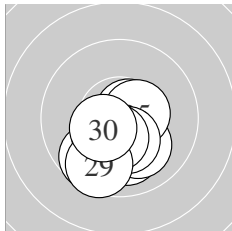

Serie 3:
 9.7 ✓ 10.7 * 10.0 ↓ 10.1 ↘ 10.5 *
 10.3 * 10.3 * 10.4 * 9.6 ✓ 10.4 *
 beste Teiler 69.9 (22.) 117.1 (25.) 128.7 (30.)
 Trefferlage 0.16 mm links, 1.37 mm tief
 Streuwert 1.11, horizontal: 1.09, vertikal: 1.13

Unterschrift des Schützen

Ergebnis: **310.2** (297)
 Serien: 103.2 104.1 102.9
 Zähler: 27 3 0 0 0 0 0 0 0 0
 Innenzehner: 23
 weiteste: 315 (5), 270 (23), 254 (24)
 beste Teiler 15.8 (26.) 20.3 (6.) 43.5 (21.)
 Trefferlage 0.06 mm links, 0.18 mm tief
 Streuwert 1.21, horizontal: 1.32, vertikal: 1.09

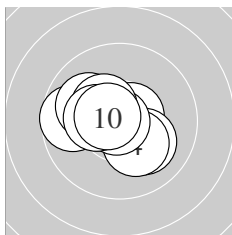
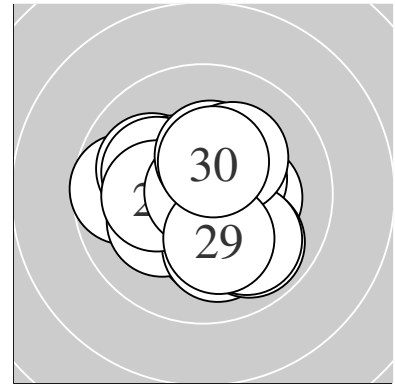

Serie 1:
 10.6 * 10.1 ↘ 10.4 * 10.2 * 9.7 ←
 10.9 * 10.0 ↙ 10.4 * 10.3 * 10.6 *
 beste Teiler 20.3 (6.) 83.6 (1.) 88.0 (10.)
 Trefferlage 0.68 mm links, 0.04 mm hoch
 Streuwert 1.21, horizontal: 1.50, vertikal: 0.84

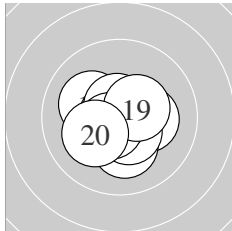

Serie 2:
 10.1 ↖ 10.7 * 10.5 * 10.2 * 10.2 *
 10.5 * 10.7 * 10.6 * 10.4 * 10.2 *
 beste Teiler 55.0 (12.) 72.5 (17.) 86.3 (18.)
 Trefferlage 0.01 mm rechts, 0.22 mm tief
 Streuwert 1.06, horizontal: 1.21, vertikal: 0.89

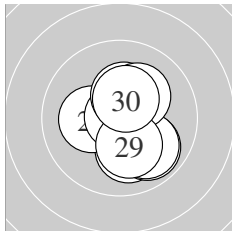

Serie 3:
 10.8 * 10.1 ↓ 9.9 ↘ 9.9 ↘ 10.2 *
 10.9 * 10.3 * 10.2 * 10.2 * 10.4 *
 beste Teiler 15.8 (26.) 43.5 (21.) 136.6 (30.)
 Trefferlage 0.47 mm rechts, 0.38 mm tief
 Streuwert 1.30, horizontal: 1.07, vertikal: 1.48

 Unterschrift des Schützen

Ergebnis: **308.0** (293)
 Serien: 104.0 101.8 102.2
 Zähler: 24 5 1 0 0 0 0 0 0 0
 Innenzehner: 20
 weiteste: 604 (18), 342 (21), 341 (6)
 beste Teiler 53.0 (20.) 60.1 (26.) 60.8 (9.)
 Trefferlage 0.10 mm links, 0.24 mm tief
 Streuwert 1.46, horizontal: 1.75, vertikal: 1.10

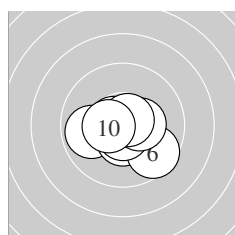
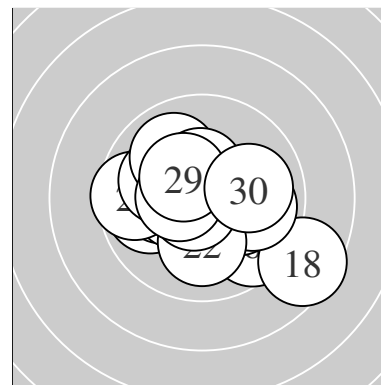

Serie 1:
 10.5 * 10.6 * 10.6 * 9.9 ← 10.5 *
 9.6 ↘ 10.7 * 10.4 * 10.7 * 10.5 *
 beste Teiler 60.8 (9.) 75.1 (7.) 76.4 (3.)
 Trefferlage 0.05 mm links, 0.58 mm tief
 Streuwert 1.14, horizontal: 1.41, vertikal: 0.79

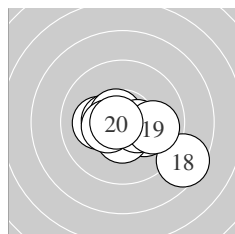

Serie 2:
 10.2 * 10.1 ← 10.5 * 10.6 * 10.5 *
 10.4 * 10.4 * 8.5 ↘ 9.9 → 10.7 *
 beste Teiler 53.0 (20.) 79.9 (14.) 122.0 (15.)
 Trefferlage 0.51 mm rechts, 0.56 mm tief
 Streuwert 1.71, horizontal: 2.18, vertikal: 1.05

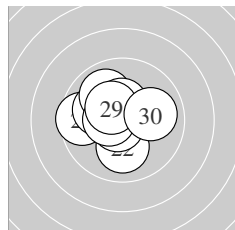

Serie 3:
 9.6 ← 10.1 ↓ 10.1 ↖ 9.9 ↘ 10.5 *
 10.7 * 10.4 * 10.5 * 10.4 * 10.0 →
 beste Teiler 60.1 (26.) 114.1 (28.) 114.5 (25.)
 Trefferlage 0.76 mm links, 0.43 mm hoch
 Streuwert 1.35, horizontal: 1.50, vertikal: 1.18

Unterschrift des Schützen

Meyton Elektronik

Ergebnis: **308.0** (292)
 Serien: 103.5 102.6 101.9
 Zähler: 22 8 0 0 0 0 0 0 0 0
 Innenzehner: 17
 weiteste: 404 (3), 310 (24), 265 (20)
 beste Teiler 33.9 (7.) 39.4 (9.) 49.0 (25.)
 Trefferlage 0.17 mm rechts, 0.24 mm hoch
 Streuwert 1.37, horizontal: 1.63, vertikal: 1.06

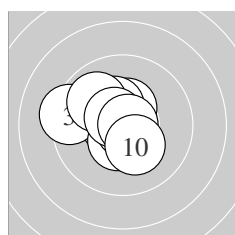
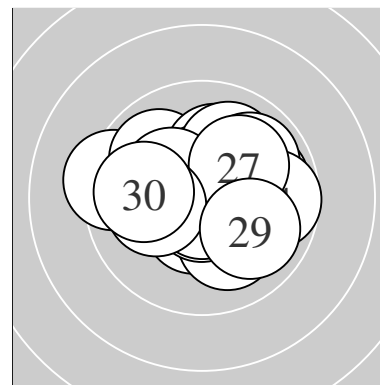

Serie 1:
 10.4 * 10.6 * 9.3 ← 10.5 * 10.3 *
 9.9 ↘ 10.8 * 10.6 * 10.8 * 10.3 *
 beste Teiler 33.9 (7.) 39.4 (9.) 83.0 (2.)
 Trefferlage 0.64 mm links, 0.29 mm hoch
 Streuwert 1.25, horizontal: 1.42, vertikal: 1.07

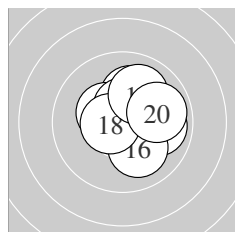

Serie 2:
 10.1 ↑ 10.6 * 9.9 → 10.5 * 10.4 *
 10.1 ↓ 10.5 * 10.6 * 10.0 ↗ 9.9 →
 beste Teiler 92.7 (18.) 96.4 (12.) 108.0 (17.)
 Trefferlage 0.75 mm rechts, 0.29 mm hoch
 Streuwert 1.25, horizontal: 1.25, vertikal: 1.25

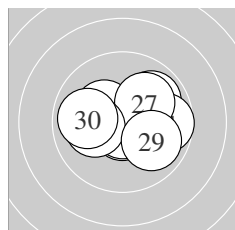

Serie 3:
 10.5 * 9.9 ↗ 10.7 * 9.7 → 10.8 *
 10.3 * 10.1 ↗ 10.1 ← 9.9 ↘ 9.9 ←
 beste Teiler 49.0 (25.) 62.0 (23.) 116.4 (21.)
 Trefferlage 0.41 mm rechts, 0.14 mm hoch
 Streuwert 1.53, horizontal: 1.94, vertikal: 0.94

Unterschrift des Schützen

Meyton Elektronik

Ergebnis: **302.1** (287)
 Serien: 100.1 102.1 99.9
 Zähler: 19 9 2 0 0 0 0 0 0 0
 Innenzehner: 14
 weiteste: 703 (25), 526 (6), 320 (7)
 beste Teiler 40.0 (23.) 43.0 (11.) 43.2 (15.)
 Trefferlage 0.02 mm rechts, 0.07 mm tief
 Streuwert 1.87, horizontal: 2.06, vertikal: 1.67

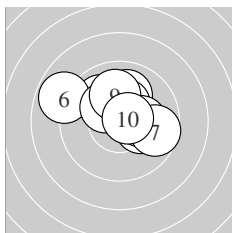
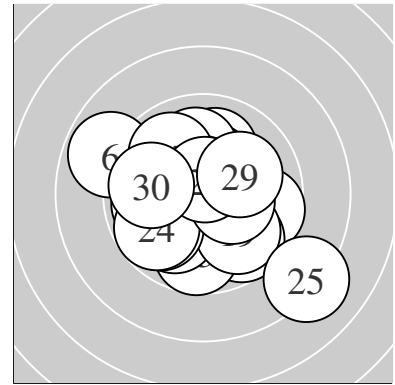

Serie 1:
 10.0 ↑ 10.3 * 10.0 ↘ 10.2 * 10.2 *
 8.8 ↖ 9.7 → 10.3 * 10.0 ↑ 10.6 *
 beste Teiler 76.2 (10.) 154.4 (2.) 173.2 (8.)
 Trefferlage 0.04 mm rechts, 0.99 mm hoch
 Streuwert 1.80, horizontal: 2.25, vertikal: 1.19

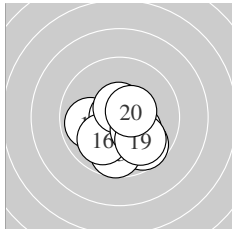

Serie 2:
 10.8 * 9.7 ↘ 9.7 ↓ 9.9 ← 10.8 *
 10.0 ↙ 10.6 * 10.2 * 9.9 ↘ 10.5 *
 beste Teiler 43.0 (11.) 43.2 (15.) 81.3 (17.)
 Trefferlage 0.13 mm rechts, 0.91 mm tief
 Streuwert 1.42, horizontal: 1.47, vertikal: 1.37

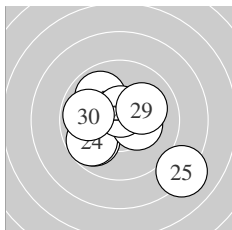

Serie 3:
 10.5 * 9.8 ↙ 10.8 * 9.8 ↙ 8.1 ↘
 10.3 * 9.9 ↘ 10.7 * 10.1 → 9.9 ←
 beste Teiler 40.0 (23.) 75.6 (28.) 115.6 (21.)
 Trefferlage 0.10 mm links, 0.31 mm tief
 Streuwert 2.23, horizontal: 2.53, vertikal: 1.88

Unterschrift des Schützen

Ergebnis: **308.4** (292)
 Serien: 103.3 104.1 101.0
 Zähler: 22 8 0 0 0 0 0 0 0 0
 Innenzehner: 21
 weiteste: 415 (13), 376 (2), 369 (30)
 beste Teiler 4.0 (17.) 18.6 (12.) 33.1 (15.)
 Trefferlage 0.52 mm links, 0.26 mm tief
 Streuwert 1.38, horizontal: 1.78, vertikal: 0.79

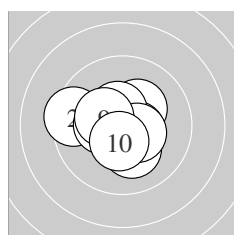
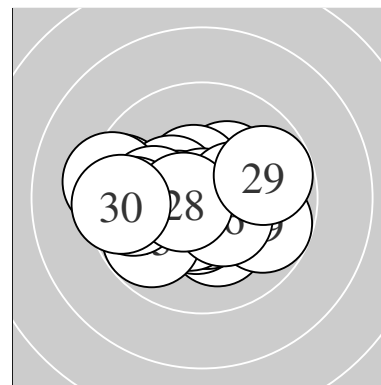

Serie 1:
 10.3 * 9.4 ← 10.7 * 10.2 * 10.5 *
 10.5 * 10.4 * 10.5 * 10.3 * 10.5 *
 beste Teiler 60.0 (3.) 104.3 (5.) 113.5 (6.)
 Trefferlage 0.39 mm links, 0.06 mm tief
 Streuwert 1.28, horizontal: 1.52, vertikal: 0.98

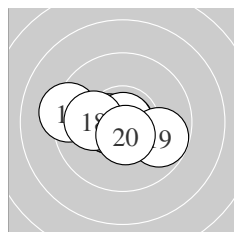

Serie 2:
 10.5 * 10.9 * 9.3 ← 10.6 * 10.8 *
 10.6 * 10.9 * 10.1 ← 9.8 → 10.6 *
 beste Teiler 4.0 (17.) 18.6 (12.) 33.1 (15.)
 Trefferlage 0.50 mm links, 0.26 mm tief
 Streuwert 1.32, horizontal: 1.78, vertikal: 0.56

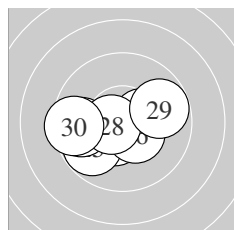

Serie 3:
 9.9 ← 10.5 * 10.5 * 10.3 * 9.8 ↙
 10.4 * 9.7 ← 10.6 * 9.8 → 9.5 ←
 beste Teiler 86.1 (28.) 102.9 (23.) 120.3 (22.)
 Trefferlage 0.66 mm links, 0.47 mm tief
 Streuwert 1.64, horizontal: 2.18, vertikal: 0.81

Unterschrift des Schützen

Meyton Elektronik

Ergebnis: **300.6** (288)
 Serien: 100.1 101.0 99.5
 Zähler: 19 10 1 0 0 0 0 0 0 0
 Innenzehner: 15
 weiteste: 635 (8), 487 (27), 433 (25)
 beste Teiler 49.0 (23.) 55.0 (29.) 82.2 (20.)
 Trefferlage 0.78 mm links, 0.60 mm tief
 Streuwert 1.78, horizontal: 2.28, vertikal: 1.09

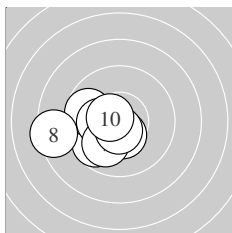
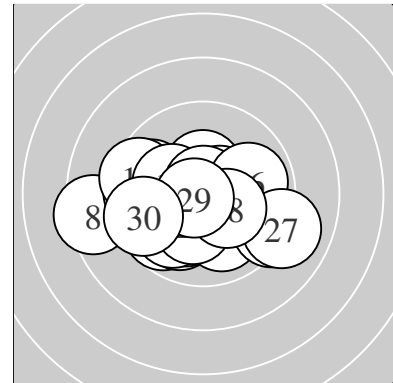

Serie 1:
 10.4 * 10.1 ← 9.7 ↙ 9.7 ↖ 10.4 *
 10.2 * 10.0 ↙ 8.4 ← 10.6 * 10.6 *
 beste Teiler 87.3 (9.) 97.1 (10.) 134.6 (1.)
 Trefferlage 1.82 mm links, 0.82 mm tief
 Streuwert 1.47, horizontal: 1.84, vertikal: 0.96

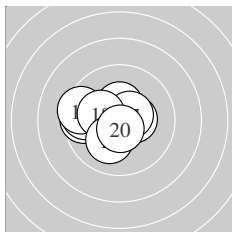

Serie 2:
 9.6 ← 10.2 * 9.6 ← 10.4 * 10.4 *
 9.4 ← 10.5 * 10.2 * 10.1 ↙ 10.6 *
 beste Teiler 82.2 (20.) 106.8 (17.) 133.2 (14.)
 Trefferlage 1.25 mm links, 0.11 mm hoch
 Streuwert 1.44, horizontal: 1.82, vertikal: 0.92

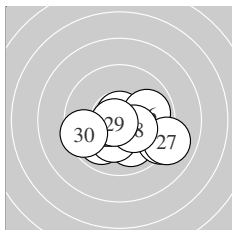

Serie 3:
 10.0 ↘ 9.9 ↙ 10.8 * 10.2 * 9.2 ↘
 9.9 → 9.0 ↘ 10.3 * 10.7 * 9.5 ←
 beste Teiler 49.0 (23.) 55.0 (29.) 157.9 (28.)
 Trefferlage 0.71 mm rechts, 1.09 mm tief
 Streuwert 1.89, horizontal: 2.46, vertikal: 1.06

Unterschrift des Schützen

Ergebnis: **308.8** (295)
 Serien: 103.3 101.8 103.7
 Zähler: 25 5 0 0 0 0 0 0 0 0
 Innenzehner: 21
 weiteste: 451 (30), 336 (8), 294 (18)
 beste Teiler 47.0 (22.) 49.0 (28.) 57.2 (10.)
 Trefferlage 0.09 mm links, 0.13 mm tief
 Streuwert 1.36, horizontal: 1.43, vertikal: 1.29

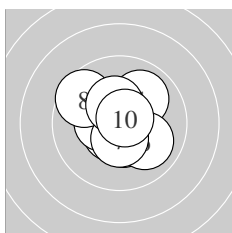
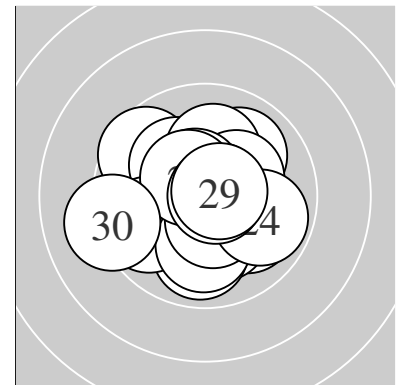

Serie 1:
 10.6 * 10.5 * 10.4 * 10.0 ↗ 10.6 *
 10.0 ↘ 10.5 * 9.6 ↖ 10.4 * 10.7 *
 beste Teiler 57.2 (10.) 86.2 (5.) 95.7 (1.)
 Trefferlage 0.01 mm links, 0.06 mm hoch
 Streuwert 1.33, horizontal: 1.37, vertikal: 1.29

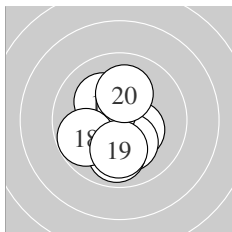

Serie 2:
 10.3 * 10.4 * 10.4 * 10.2 * 10.5 *
 10.2 * 9.9 ↓ 9.8 ↙ 10.0 ↓ 10.1 ↑
 beste Teiler 119.0 (15.) 126.1 (12.) 147.4 (13.)
 Trefferlage 0.37 mm links, 0.43 mm tief
 Streuwert 1.43, horizontal: 1.11, vertikal: 1.69

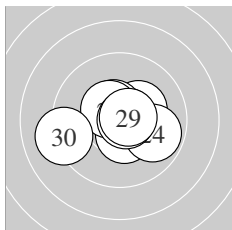

Serie 3:
 10.3 * 10.8 * 10.5 * 9.8 ↘ 10.7 *
 10.5 * 10.5 * 10.8 * 10.7 * 9.1 ←
 beste Teiler 47.0 (22.) 49.0 (28.) 61.3 (25.)
 Trefferlage 0.09 mm rechts, 0.03 mm tief
 Streuwert 1.41, horizontal: 1.82, vertikal: 0.83

Unterschrift des Schützen

Ergebnis: **295.7** (282)
 Serien: 98.0 99.6 98.1
 Zähler: 14 14 2 0 0 0 0 0 0 0
 Innenzehner: 10
 weiteste: 564 (10), 531 (27), 451 (3)
 beste Teiler 99.1 (6.) 132.5 (7.) 144.5 (12.)
 Trefferlage 0.62 mm rechts, 1.25 mm tief
 Streuwert 1.88, horizontal: 1.71, vertikal: 2.04

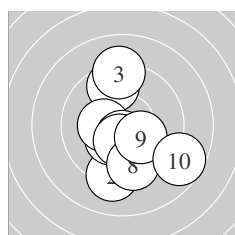
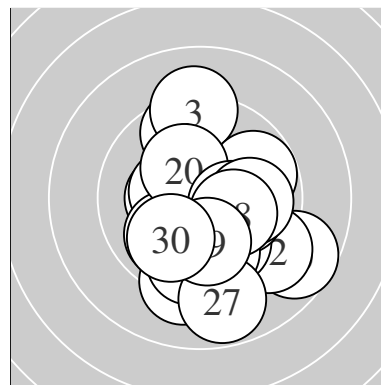

Serie 1:
 9.6 ↑ 9.2 ↓ 9.1 ↑ 10.3 * 10.3 *
 10.6 * 10.4 * 9.6 ↓ 10.2 * 8.7 ↘
 beste Teiler 99.1 (6.) 132.5 (7.) 152.3 (4.)
 Trefferlage 0.23 mm rechts, 0.71 mm tief
 Streuwert 2.36, horizontal: 1.87, vertikal: 2.77

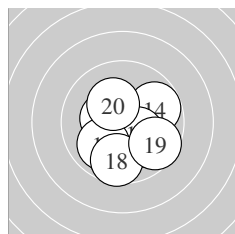

Serie 2:
 10.0 ↙ 10.4 * 9.9 ↘ 9.8 → 9.7 ↓
 10.3 * 10.0 ↙ 9.6 ↓ 9.6 ↘ 10.3 *
 beste Teiler 144.5 (12.) 157.2 (16.) 174.0 (20.)
 Trefferlage 0.26 mm rechts, 1.14 mm tief
 Streuwert 1.72, horizontal: 1.78, vertikal: 1.65

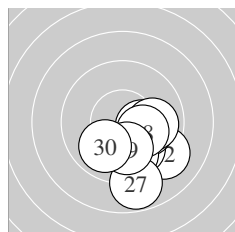

Serie 3:
 10.3 * 9.2 ↘ 9.9 ↘ 10.1 → 9.8 ↓
 9.9 → 8.8 ↓ 10.2 * 10.0 ↓ 9.9 ↙
 beste Teiler 165.7 (21.) 188.3 (28.) 220.7 (24.)
 Trefferlage 1.37 mm rechts, 1.90 mm tief
 Streuwert 1.43, horizontal: 1.34, vertikal: 1.51

Unterschrift des Schützen

Meyton Elektronik

Ergebnis: **299.2** (285)
 Serien: 100.1 99.2 99.9
 Zähler: 15 15 0 0 0 0 0 0 0 0
 Innenzehner: 12
 weiteste: 464 (29), 433 (30), 419 (18)
 beste Teiler 40.3 (20.) 83.0 (7.) 85.7 (26.)
 Trefferlage 0.26 mm rechts, 1.16 mm hoch
 Streuwert 1.76, horizontal: 2.07, vertikal: 1.38

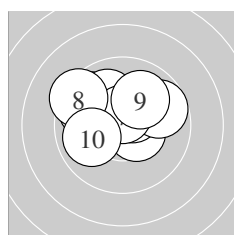
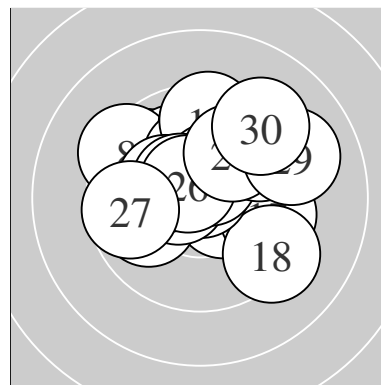

Serie 1:
 10.5 * 9.8 ↖ 10.5 * 9.7 → 9.7 ↖
 10.0 ↘ 10.6 * 9.4 ↖ 10.0 ↗ 9.9 ←
 beste Teiler 83.0 (7.) 117.0 (3.) 119.8 (1.)
 Trefferlage 0.60 mm links, 1.06 mm hoch
 Streuwert 1.66, horizontal: 2.09, vertikal: 1.06

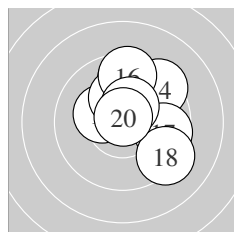

Serie 2:
 10.0 ↗ 9.6 ↑ 10.3 * 9.4 ↗ 10.2 *
 9.5 ↑ 9.7 → 9.3 ↘ 10.4 * 10.8 *
 beste Teiler 40.3 (20.) 135.1 (19.) 168.6 (13.)
 Trefferlage 0.97 mm rechts, 1.25 mm hoch
 Streuwert 1.77, horizontal: 1.61, vertikal: 1.91

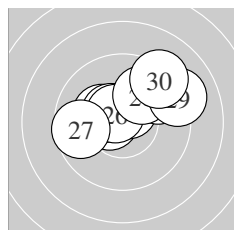

Serie 3:
 10.6 * 10.3 * 10.5 * 10.5 * 9.6 ↗
 10.6 * 9.6 ← 9.9 ↗ 9.1 → 9.2 ↗
 beste Teiler 85.7 (26.) 100.4 (21.) 104.7 (23.)
 Trefferlage 0.43 mm rechts, 1.19 mm hoch
 Streuwert 1.83, horizontal: 2.33, vertikal: 1.14

Unterschrift des Schützen

Meyton Elektronik

Ergebnis: **261.4** (246)
 Serien: 85.9 88.1 87.4
 Zähler: 3 10 9 6 2 0 0 0 0 0
 Innenzehner: 2
 weiteste: 1005 (14), 1004 (5), 975 (2)
 beste Teiler 193.5 (29.) 193.6 (16.) 208.5 (18.)
 Trefferlage 1.89 mm rechts, 0.51 mm tief
 Streuwert 4.19, horizontal: 5.29, vertikal: 2.65

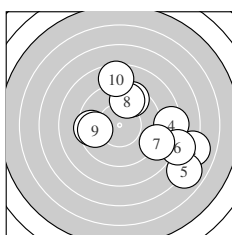
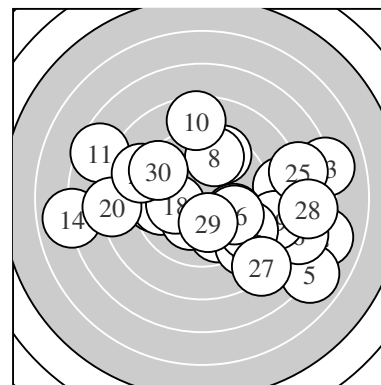

Serie 1:
 9.5 ← 7.1 → 9.5 ↑ 8.3 → 6.9 ↘
 7.8 ↘ 8.9 ↘ 9.6 ↑ 9.7 ← 8.6 ↑
 beste Teiler 316.1 (9.) 328.0 (8.) 362.7 (1.)
 Trefferlage 3.15 mm rechts, 0.22 mm tief
 Streuwert 4.16, horizontal: 4.73, vertikal: 3.50

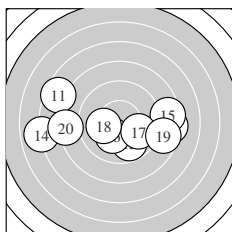

Serie 2:
 7.5 ↖ 8.4 → 9.8 ↘ 6.9 ← 8.5 →
 10.2 * 9.9 ↘ 10.1 ← 8.6 → 8.2 ←
 beste Teiler 193.6 (16.) 208.5 (18.) 267.0 (17.)
 Trefferlage 0.57 mm links, 0.61 mm tief
 Streuwert 4.42, horizontal: 6.02, vertikal: 1.72

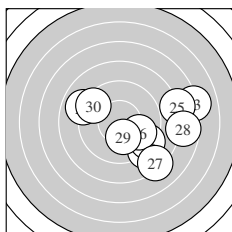

Serie 3:
 8.9 ↖ 9.0 ↘ 7.1 → 9.2 ↘ 7.9 →
 9.8 ↘ 8.2 ↘ 7.7 → 10.2 * 9.4 ↖
 beste Teiler 193.5 (29.) 279.1 (26.) 394.5 (30.)
 Trefferlage 3.11 mm rechts, 0.70 mm tief
 Streuwert 3.80, horizontal: 4.64, vertikal: 2.70

Unterschrift des Schützen

Meyton Elektronik

Ergebnis: **311.2** (298)
 Serien: 103.5 105.4 102.3
 Zähler: 28 2 0 0 0 0 0 0 0 0
 Innenzehner: 22
 weiteste: 343 (9), 254 (30), 247 (27)
 beste Teiler 47.5 (19.) 50.0 (7.) 54.5 (12.)
 Trefferlage 0.43 mm links, 0.57 mm tief
 Streuwert 1.06, horizontal: 1.01, vertikal: 1.11

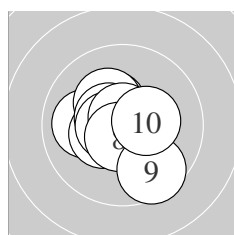
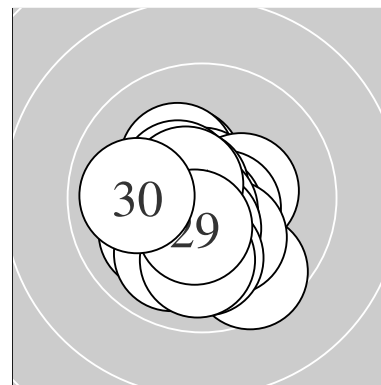

Serie 1:
 10.4 * 10.0 ← 10.3 * 10.4 * 10.5 *
 10.6 * 10.8 * 10.6 * 9.6 ↘ 10.3 *
 beste Teiler 50.0 (7.) 79.4 (8.) 84.0 (6.)
 Trefferlage 0.38 mm links, 0.01 mm tief
 Streuwert 1.25, horizontal: 1.27, vertikal: 1.23

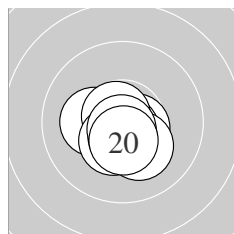

Serie 2:
 10.6 * 10.7 * 10.7 * 10.2 * 10.2 *
 10.7 * 10.4 * 10.6 * 10.8 * 10.5 *
 beste Teiler 47.5 (19.) 54.5 (12.) 58.7 (16.)
 Trefferlage 0.08 mm links, 0.65 mm tief
 Streuwert 0.70, horizontal: 0.80, vertikal: 0.59

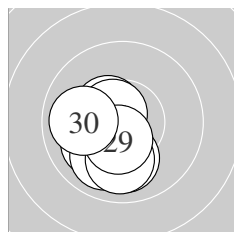

Serie 3:
 10.6 * 10.1 ↓ 10.5 * 10.1 ↙ 10.6 *
 10.0 ↓ 10.0 ↙ 10.0 ↓ 10.5 * 9.9 ←
 beste Teiler 83.7 (25.) 97.6 (21.) 117.6 (29.)
 Trefferlage 0.82 mm links, 1.07 mm tief
 Streuwert 1.05, horizontal: 0.84, vertikal: 1.23

Unterschrift des Schützen

Ergebnis: **311.3** (294)
 Serien: 103.8 106.2 101.3
 Zähler: 24 6 0 0 0 0 0 0 0 0
 Innenzehner: 21
 weiteste: 353 (28), 335 (25), 310 (2)
 beste Teiler 8.2 (12.) 12.1 (6.) 39.8 (7.)
 Trefferlage 0.04 mm links, 0.19 mm tief
 Streuwert 1.24, horizontal: 1.21, vertikal: 1.27

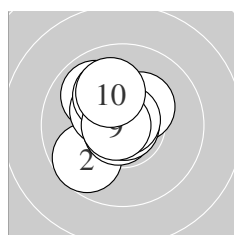
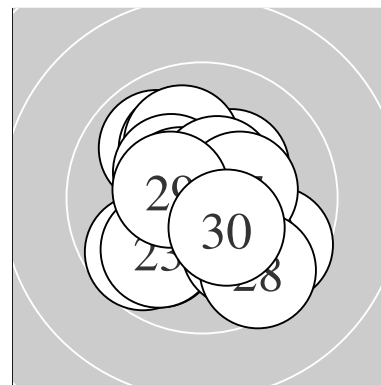

Serie 1:
 9.9 ↘ 9.7 ↙ 10.4 * 10.8 * 10.3 *
 10.9 * 10.8 * 10.1 ↖ 10.8 * 10.1 ↗
 beste Teiler 12.1 (6.) 39.8 (7.) 42.0 (9.)
 Trefferlage 0.62 mm links, 0.59 mm hoch
 Streuwert 1.16, horizontal: 1.00, vertikal: 1.30

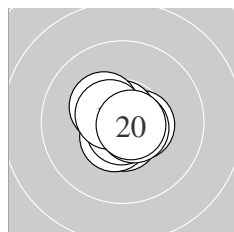

Serie 2:
 10.6 * 10.9 * 10.5 * 10.8 * 10.3 *
 10.5 * 10.7 * 10.6 * 10.6 * 10.7 *
 beste Teiler 8.2 (12.) 46.0 (14.) 51.7 (17.)
 Trefferlage 0.01 mm links, 0.11 mm tief
 Streuwert 0.67, horizontal: 0.71, vertikal: 0.63

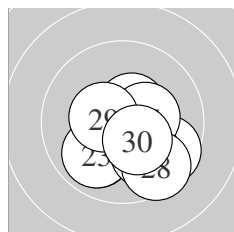

Serie 3:
 10.7 * 9.9 ↙ 9.9 ↙ 10.5 * 9.6 ↘
 10.0 ↘ 10.4 * 9.5 ↘ 10.4 * 10.4 *
 beste Teiler 56.6 (21.) 108.7 (24.) 126.1 (29.)
 Trefferlage 0.50 mm rechts, 1.07 mm tief
 Streuwert 1.43, horizontal: 1.58, vertikal: 1.26

Unterschrift des Schützen

Meyton Elektronik

Ergebnis: **284.2** (272)
 Serien: 97.3 94.2 92.7
 Zähler: 9 14 7 0 0 0 0 0 0 0
 Innenzehner: 4
 weiteste: 723 (14), 637 (23), 609 (19)
 beste Teiler 29.6 (18.) 56.3 (5.) 168.0 (22.)
 Trefferlage 1.41 mm links, 2.57 mm tief
 Streuwert 2.03, horizontal: 2.40, vertikal: 1.59

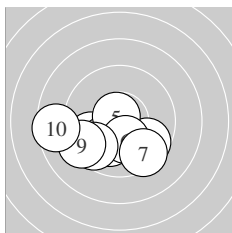
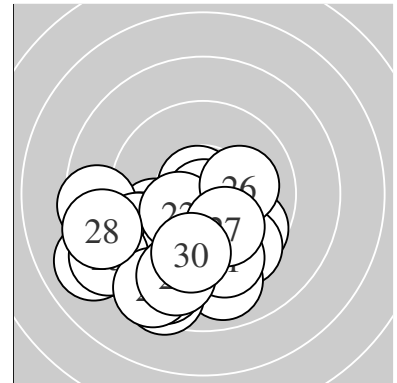

Serie 1:
 9.7 ↙ 9.7 ↘ 10.0 ✓ 10.1 ↓ 10.7 *
 10.2 * 9.5 ↘ 9.6 ✓ 9.3 ↙ 8.5 ←
 beste Teiler 56.3 (5.) 180.5 (6.) 220.6 (4.)
 Trefferlage 1.20 mm links, 1.65 mm tief
 Streuwert 1.98, horizontal: 2.63, vertikal: 0.96

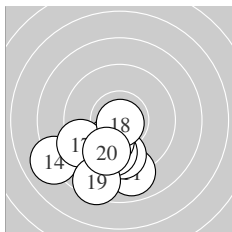

Serie 2:
 9.0 ↓ 9.6 ↓ 9.5 ✓ 8.1 ↙ 9.7 ↓
 10.1 ↓ 9.2 ↙ 10.8 * 8.5 ↓ 9.7 ↓
 beste Teiler 29.6 (18.) 214.9 (16.) 306.7 (15.)
 Trefferlage 1.53 mm links, 3.08 mm tief
 Streuwert 1.85, horizontal: 2.14, vertikal: 1.51

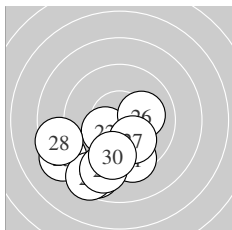

Serie 3:
 9.4 ↓ 10.3 * 8.4 ↙ 8.7 ↓ 8.6 ↙
 10.1 → 10.1 ↘ 8.5 ← 9.0 ↓ 9.6 ↓
 beste Teiler 168.0 (22.) 210.3 (26.) 222.1 (27.)
 Trefferlage 1.50 mm links, 2.97 mm tief
 Streuwert 2.28, horizontal: 2.64, vertikal: 1.86

Unterschrift des Schützen

Ergebnis: **288.7** (276)
 Serien: 95.5 98.7 94.5
 Zähler: 16 7 4 3 0 0 0 0 0 0
 Innenzehner: 8
 weiteste: 967 (7), 843 (8), 775 (24)
 beste Teiler 26.4 (10.) 55.9 (5.) 93.4 (23.)
 Trefferlage 0.00 mm , 0.66 mm hoch
 Streuwert 2.87, horizontal: 3.40, vertikal: 2.23

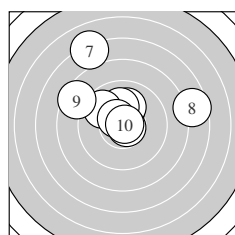
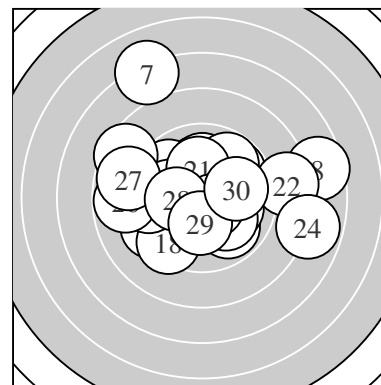

Serie 1:
 10.4 * 10.1 ↑ 10.1 ↑ 9.7 ↘ 10.7 *
 10.5 * 7.1 ↖ 7.6 → 8.5 ↘ 10.8 *
 beste Teiler 26.4 (10.) 55.9 (5.) 105.4 (6.)
 Trefferlage 0.29 mm links, 2.21 mm hoch
 Streuwert 3.12, horizontal: 3.61, vertikal: 2.54

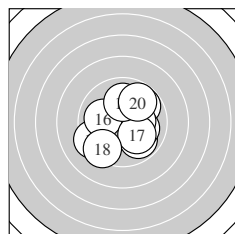

Serie 2:
 9.8 ↗ 9.9 ↘ 9.3 ↙ 10.1 ↘ 10.3 *
 10.0 ← 10.1 ↘ 9.4 ↙ 10.0 ↑ 9.8 ↗
 beste Teiler 166.3 (15.) 223.2 (14.) 223.2 (17.)
 Trefferlage 0.31 mm rechts, 0.22 mm tief
 Streuwert 2.09, horizontal: 2.21, vertikal: 1.97

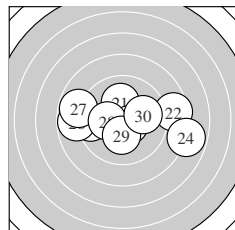

Serie 3:
 10.1 ↑ 8.5 → 10.6 * 7.9 → 9.4 ←
 8.8 ← 8.8 ← 10.2 * 10.2 * 10.0 →
 beste Teiler 93.4 (23.) 178.4 (29.) 180.2 (28.)
 Trefferlage 0.00 mm , 0.01 mm hoch
 Streuwert 3.22, horizontal: 4.37, vertikal: 1.31

Unterschrift des Schützen

Meyton Elektronik

Ergebnis: **310.0** (296)
 Serien: 102.9 104.1 103.0
 Zähler: 26 4 0 0 0 0 0 0 0 0
 Innenzehner: 22
 weiteste: 330 (10), 325 (9), 286 (26)
 beste Teiler 20.2 (21.) 38.2 (20.) 44.1 (13.)
 Trefferlage 0.36 mm links, 0.77 mm tief
 Streuwert 1.11, horizontal: 1.33, vertikal: 0.84

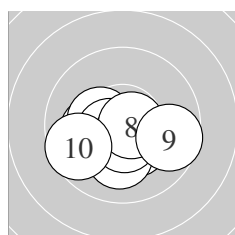
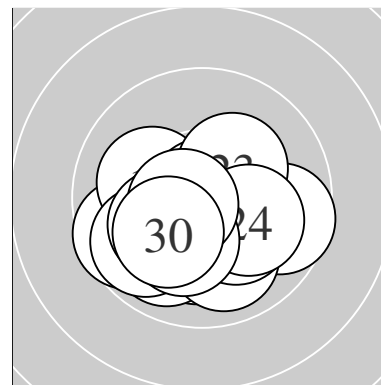

Serie 1:
 10.2 * 10.4 * 10.1 ↓ 10.3 * 10.7 *
 10.6 * 10.6 * 10.7 * 9.7 → 9.6 ←
 beste Teiler 59.0 (8.) 68.7 (5.) 95.8 (7.)
 Trefferlage 0.32 mm links, 0.75 mm tief
 Streuwert 1.30, horizontal: 1.69, vertikal: 0.70

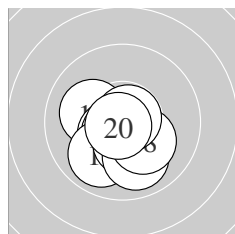

Serie 2:
 10.1 ← 10.5 * 10.8 * 10.6 * 9.9 ↙
 10.4 * 10.0 ↓ 10.2 * 10.8 * 10.8 *
 beste Teiler 38.2 (20.) 44.1 (13.) 45.2 (19.)
 Trefferlage 0.19 mm links, 0.83 mm tief
 Streuwert 1.00, horizontal: 1.03, vertikal: 0.96

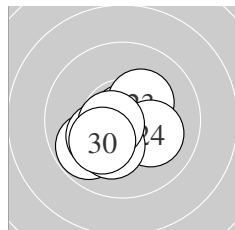

Serie 3:
 10.9 * 10.5 * 10.3 * 10.1 → 10.2 *
 9.8 ↙ 10.2 * 10.2 * 10.6 * 10.2 *
 beste Teiler 20.2 (21.) 82.5 (29.) 106.4 (22.)
 Trefferlage 0.57 mm links, 0.74 mm tief
 Streuwert 1.12, horizontal: 1.29, vertikal: 0.92

Unterschrift des Schützen

Meyton Elektronik

Ergebnis: **307.9** (294)
 Serien: 102.4 104.4 101.1
 Zähler: 25 4 1 0 0 0 0 0 0 0
 Innenzehner: 19
 weiteste: 511 (6), 330 (25), 318 (30)
 beste Teiler 35.3 (1.) 39.2 (7.) 53.3 (12.)
 Trefferlage 0.67 mm links, 0.25 mm hoch
 Streuwert 1.36, horizontal: 1.64, vertikal: 1.00

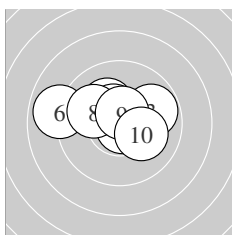
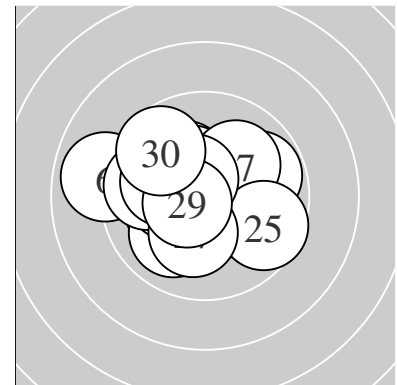

Serie 1:
 10.8 * 10.2 * 9.8 ↗ 10.7 * 10.5 *
 8.9 ↖ 10.8 * 10.0 ↖ 10.6 * 10.1 ↘
 beste Teiler 35.3 (1.) 39.2 (7.) 69.1 (4.)
 Trefferlage 0.39 mm links, 0.62 mm hoch
 Streuwert 1.58, horizontal: 2.11, vertikal: 0.73

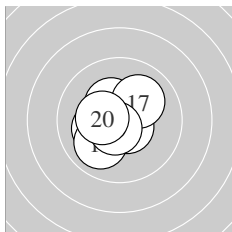

Serie 2:
 10.7 * 10.7 * 10.6 * 10.7 * 10.2 *
 10.4 * 10.1 ↗ 10.0 ↙ 10.6 * 10.4 *
 beste Teiler 53.3 (12.) 54.0 (14.) 70.0 (11.)
 Trefferlage 0.44 mm links, 0.05 mm tief
 Streuwert 1.03, horizontal: 1.07, vertikal: 0.99

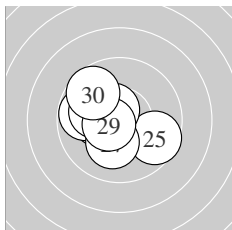

Serie 3:
 10.3 * 10.1 ↖ 10.2 * 9.8 ↖ 9.6 ↘
 10.5 * 10.2 * 10.1 ↖ 10.6 * 9.7 ↖
 beste Teiler 96.5 (29.) 103.1 (26.) 170.0 (21.)
 Trefferlage 1.18 mm links, 0.18 mm hoch
 Streuwert 1.43, horizontal: 1.63, vertikal: 1.19

Unterschrift des Schützen

Ergebnis: **305.8** (294)
 Serien: 101.2 102.2 102.4
 Zähler: 24 6 0 0 0 0 0 0 0 0
 Innenzehner: 15
 weiteste: 384 (3), 265 (2), 263 (1)
 beste Teiler 65.3 (29.) 87.1 (14.) 96.6 (9.)
 Trefferlage 0.02 mm links, 0.03 mm tief
 Streuwert 1.45, horizontal: 1.51, vertikal: 1.39

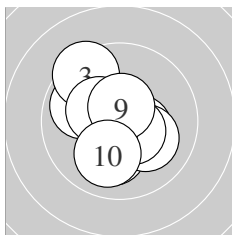
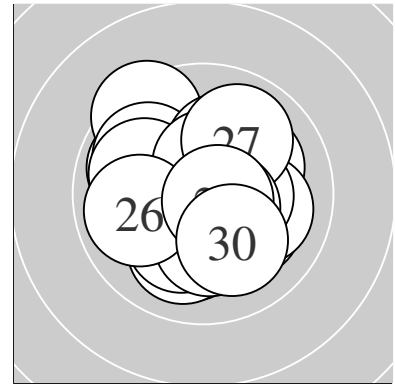

Serie 1:
 9.9 ↖ 9.9 ↖ 9.4 ↖ 10.1 ↓ 10.3 *
 10.4 * 10.1 ↘ 10.5 * 10.6 * 10.0 ↓
 beste Teiler 96.6 (9.) 107.6 (8.) 135.1 (6.)
 Trefferlage 0.55 mm links, 0.08 mm hoch
 Streuwert 1.60, horizontal: 1.52, vertikal: 1.68

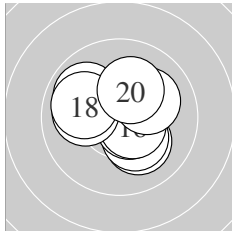

Serie 2:
 10.1 ↘ 9.9 ↖ 10.3 * 10.6 * 10.5 *
 10.5 * 10.0 ← 10.0 ← 10.1 ↗ 10.2 *
 beste Teiler 87.1 (14.) 102.3 (16.) 111.3 (15.)
 Trefferlage 0.00 mm , 0.23 mm hoch
 Streuwert 1.42, horizontal: 1.62, vertikal: 1.19

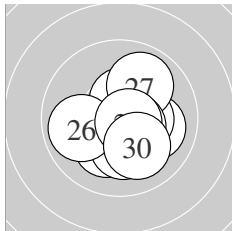

Serie 3:
 10.0 → 10.2 * 10.4 * 10.2 * 10.5 *
 9.9 ← 9.9 ↗ 10.5 * 10.7 * 10.1 ↘
 beste Teiler 65.3 (29.) 102.0 (28.) 116.7 (25.)
 Trefferlage 0.46 mm rechts, 0.43 mm tief
 Streuwert 1.33, horizontal: 1.35, vertikal: 1.30

Unterschrift des Schützen

Ergebnis: **299.2** (286)
 Serien: 100.7 99.7 98.8
 Zähler: 18 10 2 0 0 0 0 0 0 0
 Innenzehner: 13
 weiteste: 619 (14), 551 (30), 432 (10)
 beste Teiler 39.2 (6.) 71.2 (15.) 107.0 (21.)
 Trefferlage 0.76 mm links, 0.24 mm tief
 Streuwert 1.91, horizontal: 2.14, vertikal: 1.66

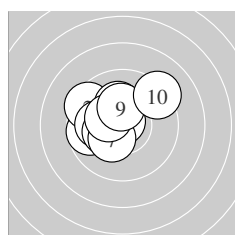
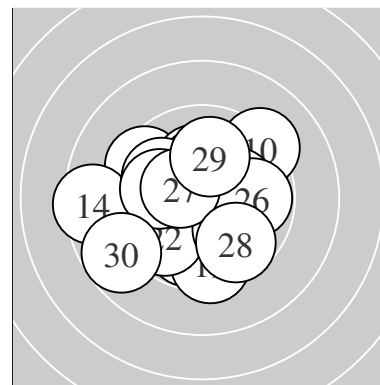

Serie 1:
 9.7 ← 9.5 ↖ 10.2 * 10.0 ← 10.3 *
 10.8 * 10.3 * 10.4 * 10.3 * 9.2 ↗
 beste Teiler 39.2 (6.) 149.3 (8.) 158.3 (7.)
 Trefferlage 0.99 mm links, 0.69 mm hoch
 Streuwert 1.62, horizontal: 1.87, vertikal: 1.32

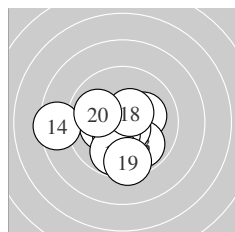

Serie 2:
 10.2 * 10.2 * 9.9 ↘ 8.5 ← 10.7 *
 10.4 * 9.8 ↓ 10.5 * 9.5 ↓ 10.0 ↖
 beste Teiler 71.2 (15.) 114.2 (18.) 131.9 (16.)
 Trefferlage 0.65 mm links, 0.87 mm tief
 Streuwert 2.01, horizontal: 2.38, vertikal: 1.56

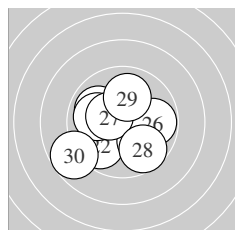

Serie 3:
 10.5 * 9.8 ↗ 9.9 ↖ 10.0 ↘ 10.0 ←
 9.8 → 10.4 * 9.7 ↘ 10.0 ↑ 8.7 ↙
 beste Teiler 107.0 (21.) 135.1 (27.) 237.1 (29.)
 Trefferlage 0.66 mm links, 0.55 mm tief
 Streuwert 2.07, horizontal: 2.33, vertikal: 1.77

Unterschrift des Schützen

Meyton Elektronik

Ergebnis: **280.0** (265)
 Serien: 97.7 94.6 87.7
 Zähler: 10 10 6 3 1 0 0 0 0 0
 Innenzehner: 7
 weiteste: 1109 (22), 965 (15), 819 (21)
 beste Teiler 57.2 (10.) 126.0 (20.) 132.0 (14.)
 Trefferlage 0.15 mm links, 1.75 mm tief
 Streuwert 3.23, horizontal: 3.73, vertikal: 2.63

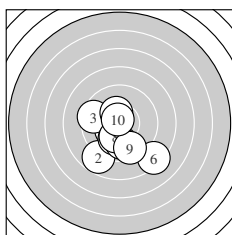
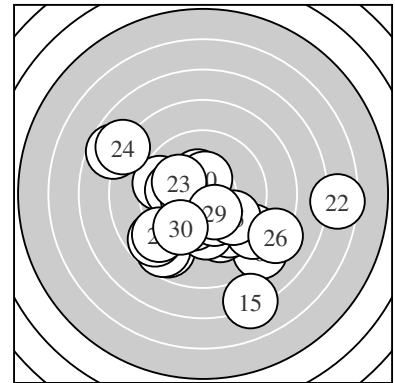

Serie 1:
 10.3 * 8.8 ↙ 9.5 ↖ 10.1 ↓ 9.9 ↓
 8.3 ↘ 10.4 * 10.2 * 9.5 ↓ 10.7 *
 beste Teiler 57.2 (10.) 149.9 (7.) 151.8 (1.)
 Trefferlage 0.32 mm links, 1.76 mm tief
 Streuwert 2.24, horizontal: 2.28, vertikal: 2.21

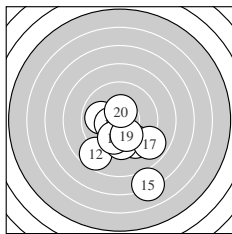

Serie 2:
 9.5 ↘ 8.7 ↙ 9.9 ↖ 10.4 * 7.1 ↓
 9.7 ↓ 8.9 ↘ 9.9 ↓ 10.1 ↓ 10.4 *
 beste Teiler 126.0 (20.) 132.0 (14.) 225.0 (19.)
 Trefferlage 0.36 mm rechts, 2.60 mm tief
 Streuwert 2.66, horizontal: 2.49, vertikal: 2.82

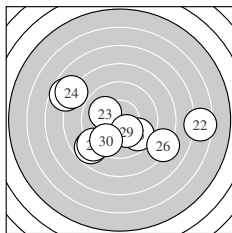

Serie 3:
 7.7 ↖ 6.5 → 10.1 ↖ 7.9 ↖ 9.7 ↘
 8.2 ↘ 8.8 ↙ 9.0 ↙ 10.2 * 9.6 ↙
 beste Teiler 178.0 (29.) 221.3 (23.) 317.6 (25.)
 Trefferlage 0.49 mm links, 0.90 mm tief
 Streuwert 4.53, horizontal: 5.76, vertikal: 2.81

Unterschrift des Schützen

Ergebnis: **290.1** (275)
 Serien: 94.4 96.0 99.7
 Zähler: 10 17 1 2 0 0 0 0 0 0
 Innenzehner: 6
 weiteste: 801 (20), 761 (3), 624 (19)
 beste Teiler 66.4 (25.) 92.8 (11.) 102.7 (12.)
 Trefferlage 0.31 mm links, 1.63 mm hoch
 Streuwert 2.34, horizontal: 2.91, vertikal: 1.57

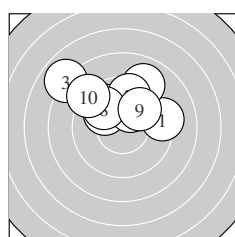
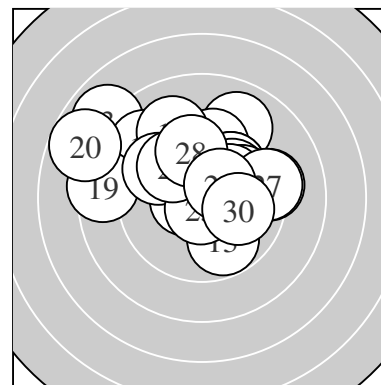

Serie 1:
 9.3 → 9.0 ↗ 7.9 ↘ 10.0 ↘ 9.7 ↘
 10.2 * 9.6 ↑ 9.8 ↘ 9.9 ↗ 9.0 ↘
 beste Teiler 188.3 (6.) 232.0 (4.) 258.1 (9.)
 Trefferlage 0.57 mm links, 2.58 mm hoch
 Streuwert 2.32, horizontal: 3.01, vertikal: 1.31

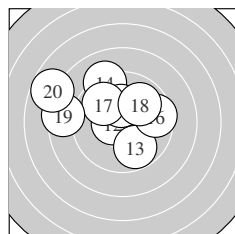

Serie 2:
 10.6 * 10.5 * 9.8 ↘ 9.2 ↗ 10.3 *
 9.6 → 9.9 ↘ 9.9 ↗ 8.5 ← 7.7 ↘
 beste Teiler 92.8 (11.) 102.7 (12.) 169.8 (15.)
 Trefferlage 1.17 mm links, 1.24 mm hoch
 Streuwert 2.73, horizontal: 3.38, vertikal: 1.85

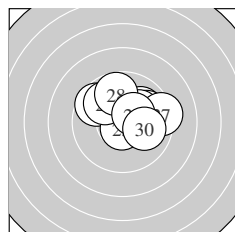

Serie 3:
 10.0 ↗ 9.9 → 9.6 ↘ 10.1 ↗ 10.7 *
 9.9 ↘ 9.3 → 9.8 ↑ 10.4 * 10.0 →
 beste Teiler 66.4 (25.) 139.4 (29.) 203.5 (24.)
 Trefferlage 0.81 mm rechts, 1.06 mm hoch
 Streuwert 1.68, horizontal: 2.10, vertikal: 1.12

Unterschrift des Schützen

Meyton Elektronik

Ergebnis: **301.8** (289)
 Serien: 100.5 99.0 102.3
 Zähler: 19 11 0 0 0 0 0 0 0 0
 Innenzehner: 11
 weiteste: 439 (13), 393 (17), 361 (4)
 beste Teiler 61.6 (27.) 75.9 (24.) 85.0 (5.)
 Trefferlage 0.10 mm links, 0.14 mm tief
 Streuwert 1.73, horizontal: 1.61, vertikal: 1.85

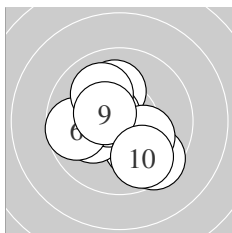
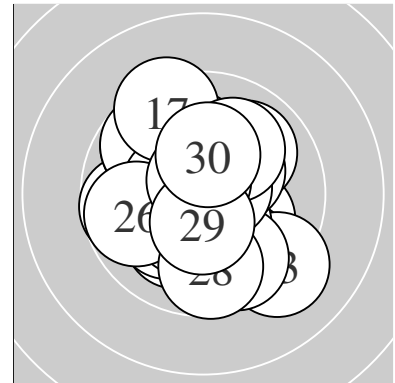

Serie 1:
 10.1 ↑ 10.1 ↘ 10.1 ← 9.5 ↘ 10.6 *
 9.7 ← 10.1 ↘ 10.0 ↘ 10.5 * 9.8 ↘
 beste Teiler 85.0 (5.) 119.4 (9.) 203.3 (3.)
 Trefferlage 0.15 mm links, 0.43 mm tief
 Streuwert 1.74, horizontal: 1.79, vertikal: 1.69

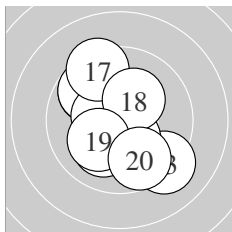

Serie 2:
 9.8 ↘ 9.7 ↘ 9.2 ↘ 10.4 * 10.4 *
 10.1 ↗ 9.4 ↗ 10.2 * 10.1 ↗ 9.7 ↘
 beste Teiler 126.8 (14.) 147.1 (15.) 178.3 (18.)
 Trefferlage 0.34 mm links, 0.07 mm tief
 Streuwert 2.07, horizontal: 1.81, vertikal: 2.30

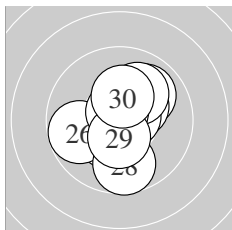

Serie 3:
 9.9 ↗ 10.4 * 10.3 * 10.7 * 10.0 ↗
 9.8 ← 10.7 * 9.7 ↓ 10.5 * 10.3 *
 beste Teiler 61.6 (27.) 75.9 (24.) 121.0 (29.)
 Trefferlage 0.17 mm rechts, 0.07 mm hoch
 Streuwert 1.49, horizontal: 1.32, vertikal: 1.64

Unterschrift des Schützen

Meyton Elektronik

Ergebnis: **309.6** (295)
 Serien: 102.5 103.8 103.3
 Zähler: 25 5 0 0 0 0 0 0 0 0
 Innenzehner: 22
 weiteste: 308 (21), 292 (18), 263 (26)
 beste Teiler 3.0 (12.) 28.0 (1.) 29.4 (8.)
 Trefferlage 0.49 mm links, 0.19 mm hoch
 Streuwert 1.21, horizontal: 1.31, vertikal: 1.11

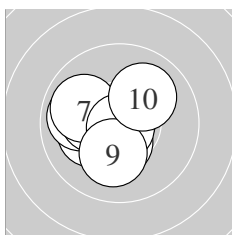
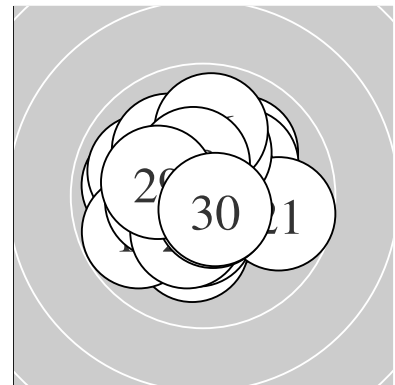

Serie 1:
 10.8 * 10.2 * 10.4 * 10.0 ↖ 9.9 ↖
 10.3 * 9.9 ↖ 10.8 * 10.2 * 10.0 ↗
 beste Teiler 28.0 (1.) 29.4 (8.) 126.0 (3.)
 Trefferlage 0.94 mm links, 0.02 mm hoch
 Streuwert 1.24, horizontal: 1.37, vertikal: 1.09

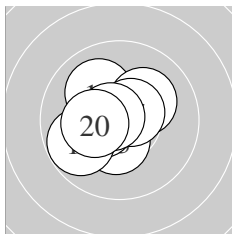

Serie 2:
 10.4 * 10.9 * 10.4 * 10.0 ↘ 10.5 *
 10.2 * 10.6 * 9.8 ↙ 10.7 * 10.3 *
 beste Teiler 3.0 (12.) 62.0 (19.) 89.8 (17.)
 Trefferlage 0.62 mm links, 0.16 mm hoch
 Streuwert 1.13, horizontal: 1.19, vertikal: 1.06

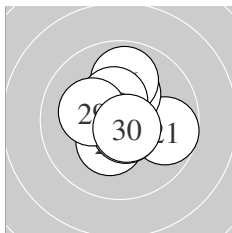

Serie 3:
 9.7 → 10.5 * 10.3 * 10.2 * 10.7 *
 9.9 ↑ 10.7 * 10.4 * 10.2 * 10.7 *
 beste Teiler 51.8 (25.) 72.2 (30.) 72.9 (27.)
 Trefferlage 0.07 mm rechts, 0.40 mm hoch
 Streuwert 1.25, horizontal: 1.26, vertikal: 1.25

Unterschrift des Schützen

Meyton Elektronik

Ergebnis: **314.1** (300)
 Serien: 103.9 105.3 104.9
 Zähler: 30 0 0 0 0 0 0 0 0 0
 Innenzehner: 25
 weiteste: 242 (18), 239 (5), 221 (3)
 beste Teiler 11.4 (13.) 39.8 (11.) 47.8 (7.)
 Trefferlage 0.13 mm links, 0.11 mm hoch
 Streuwert 0.95, horizontal: 1.00, vertikal: 0.90

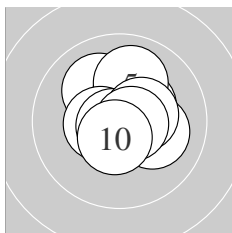
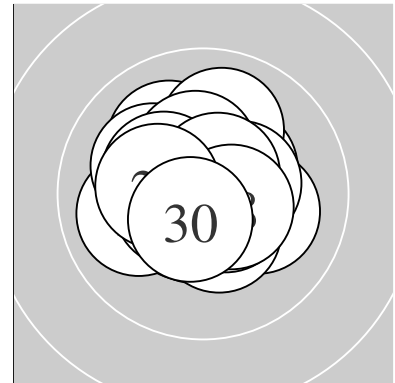

Serie 1:
 10.4 * 10.4 * 10.1 ↖ 10.1 → 10.0 ↗
 10.5 * 10.8 * 10.4 * 10.7 * 10.5 *
 beste Teiler 47.8 (7.) 71.8 (9.) 101.2 (10.)
 Trefferlage 0.25 mm rechts, 0.45 mm hoch
 Streuwert 1.08, horizontal: 1.07, vertikal: 1.10

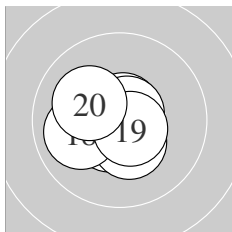

Serie 2:
 10.8 * 10.6 * 10.9 * 10.5 * 10.4 *
 10.7 * 10.7 * 10.0 ← 10.6 * 10.1 ↖
 beste Teiler 11.4 (13.) 39.8 (11.) 59.4 (17.)
 Trefferlage 0.38 mm links, 0.23 mm tief
 Streuwert 0.88, horizontal: 1.01, vertikal: 0.72

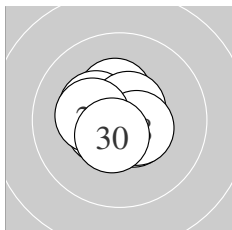

Serie 3:
 10.5 * 10.4 * 10.7 * 10.6 * 10.5 *
 10.3 * 10.6 * 10.5 * 10.3 * 10.5 *
 beste Teiler 52.2 (23.) 86.2 (27.) 99.6 (24.)
 Trefferlage 0.28 mm links, 0.12 mm hoch
 Streuwert 0.85, horizontal: 0.90, vertikal: 0.81

 Unterschrift des Schützen

Ergebnis: **300.0** (286)
 Serien: 101.6 97.8 100.6
 Zähler: 17 12 1 0 0 0 0 0 0 0
 Innenzehner: 13
 weiteste: 510 (16), 451 (12), 387 (1)
 beste Teiler 54.5 (21.) 81.6 (7.) 82.1 (2.)
 Trefferlage 0.66 mm rechts, 0.60 mm hoch
 Streuwert 1.77, horizontal: 1.71, vertikal: 1.84

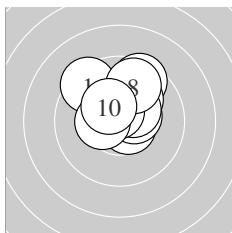
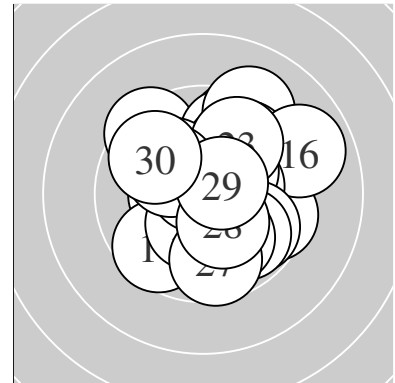

Serie 1:
 9.4 ↘ 10.6 * 9.5 ↗ 10.5 * 10.1 ↗
 10.4 * 10.6 * 9.7 ↑ 10.4 * 10.4 *
 beste Teiler 81.6 (7.) 82.1 (2.) 125.2 (4.)
 Trefferlage 0.19 mm rechts, 1.36 mm hoch
 Streuwert 1.34, horizontal: 1.39, vertikal: 1.29

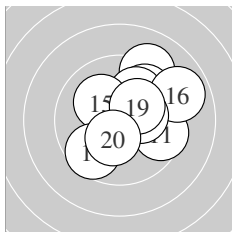

Serie 2:
 9.6 → 9.1 ↗ 9.7 ↗ 10.0 ↗ 10.1 ↘
 8.9 → 9.6 ↙ 10.3 * 10.2 * 10.3 *
 beste Teiler 154.1 (20.) 173.9 (18.) 180.2 (19.)
 Trefferlage 1.25 mm rechts, 0.83 mm hoch
 Streuwert 2.04, horizontal: 2.11, vertikal: 1.98

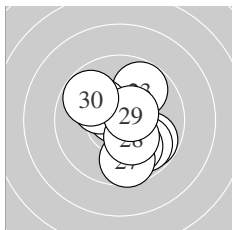

Serie 3:
 10.7 * 9.8 ↘ 9.8 ↗ 10.2 * 9.8 ↘
 10.0 ↘ 9.7 ↓ 10.3 * 10.5 * 9.8 ↘
 beste Teiler 54.5 (21.) 103.9 (29.) 167.2 (28.)
 Trefferlage 0.55 mm rechts, 0.39 mm tief
 Streuwert 1.72, horizontal: 1.54, vertikal: 1.89

Unterschrift des Schützen

Ergebnis: **311.6** (300)
 Serien: 103.6 103.4 104.6
 Zähler: 30 0 0 0 0 0 0 0 0 0
 Innenzehner: 24
 weiteste: 237 (11), 235 (15), 233 (4)
 beste Teiler 46.6 (10.) 60.6 (28.) 68.1 (23.)
 Trefferlage 0.19 mm links, 0.26 mm tief
 Streuwert 1.07, horizontal: 1.24, vertikal: 0.87

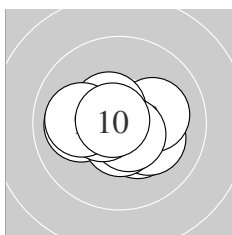
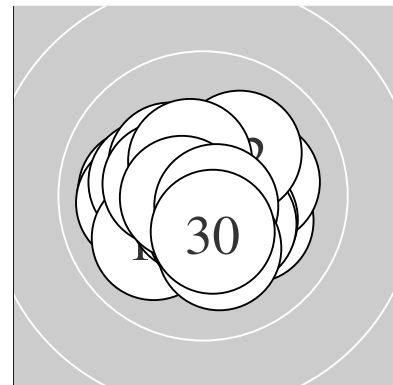

Serie 1:
 10.3 * 10.2 * 10.1 → 10.0 ← 10.5 *
 10.6 * 10.6 * 10.5 * 10.0 ← 10.8 *
 beste Teiler 46.6 (10.) 87.4 (7.) 98.1 (6.)
 Trefferlage 0.12 mm links, 0.21 mm tief
 Streuwert 1.17, horizontal: 1.52, vertikal: 0.67

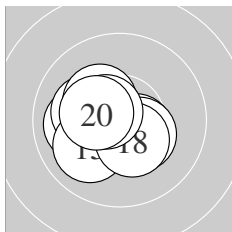

Serie 2:
 10.0 ← 10.6 * 10.5 * 10.2 * 10.0 ↙
 10.3 * 10.4 * 10.4 * 10.6 * 10.4 *
 beste Teiler 78.0 (12.) 97.7 (19.) 116.7 (13.)
 Trefferlage 0.72 mm links, 0.16 mm tief
 Streuwert 1.09, horizontal: 1.28, vertikal: 0.87

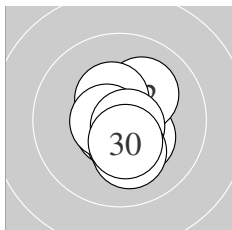

Serie 3:
 10.3 * 10.1 ↗ 10.7 * 10.4 * 10.5 *
 10.7 * 10.6 * 10.7 * 10.2 * 10.4 *
 beste Teiler 60.6 (28.) 68.1 (23.) 75.1 (26.)
 Trefferlage 0.28 mm rechts, 0.41 mm tief
 Streuwert 0.92, horizontal: 0.68, vertikal: 1.10

 Unterschrift des Schützen

Ergebnis: **308.1** (293)
 Serien: 103.0 101.4 103.7
 Zähler: 24 5 1 0 0 0 0 0 0 0
 Innenzehner: 20
 weiteste: 503 (19), 352 (9), 332 (7)
 beste Teiler 37.6 (4.) 51.0 (24.) 60.1 (25.)
 Trefferlage 0.26 mm links, 0.14 mm tief
 Streuwert 1.44, horizontal: 1.58, vertikal: 1.29

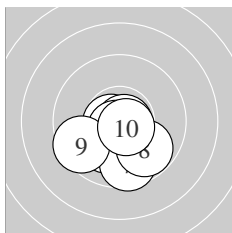
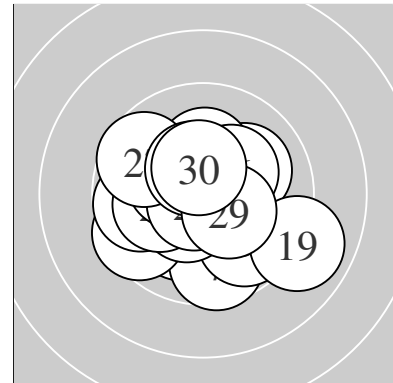

Serie 1:
 10.7 * 10.7 * 10.1 ✓ 10.8 * 10.4 *
 10.7 * 9.6 ↓ 9.8 ↘ 9.5 ← 10.7 *
 beste Teiler 37.6 (4.) 66.2 (6.) 66.8 (2.)
 Trefferlage 0.16 mm links, 1.23 mm tief
 Streuwert 1.17, horizontal: 1.29, vertikal: 1.03

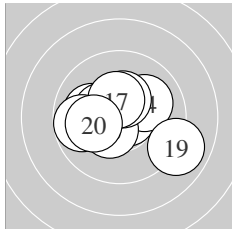

Serie 2:
 10.1 ← 10.4 * 10.7 * 10.1 → 10.5 *
 10.4 * 10.4 * 9.8 ← 8.9 ↘ 10.1 ←
 beste Teiler 61.1 (13.) 125.4 (15.) 137.6 (17.)
 Trefferlage 0.23 mm links, 0.03 mm hoch
 Streuwert 1.77, horizontal: 2.21, vertikal: 1.17

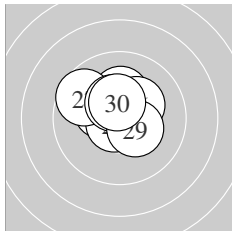

Serie 3:
 10.4 * 10.4 * 10.2 * 10.7 * 10.7 *
 10.3 * 9.7 ↖ 10.4 * 10.4 * 10.5 *
 beste Teiler 51.0 (24.) 60.1 (25.) 125.6 (30.)
 Trefferlage 0.38 mm links, 0.75 mm hoch
 Streuwert 1.04, horizontal: 1.21, vertikal: 0.84

Unterschrift des Schützen

Ergebnis: **309.1** (294)
 Serien: 103.5 102.6 103.0
 Zähler: 24 6 0 0 0 0 0 0 0 0
 Innenzehner: 23
 weiteste: 390 (19), 322 (22), 316 (30)
 beste Teiler 40.6 (4.) 47.6 (6.) 73.5 (26.)
 Trefferlage 0.21 mm links, 0.09 mm tief
 Streuwert 1.30, horizontal: 1.41, vertikal: 1.19

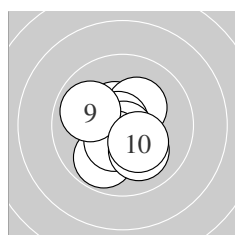
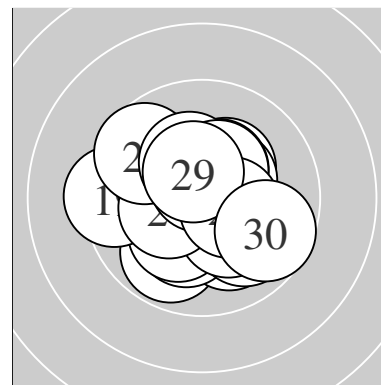

Serie 1:
 9.8 ↘ 10.5 * 10.3 * 10.8 * 10.6 *
 10.8 * 10.4 * 10.1 ↘ 9.9 ↖ 10.3 *
 beste Teiler 40.6 (4.) 47.6 (6.) 84.4 (5.)
 Trefferlage 0.25 mm links, 0.40 mm tief
 Streuwert 1.22, horizontal: 1.16, vertikal: 1.28

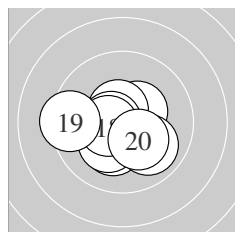

Serie 2:
 10.2 * 10.4 * 10.5 * 10.2 * 10.6 *
 10.6 * 9.9 ↘ 10.5 * 9.4 ← 10.3 *
 beste Teiler 85.0 (16.) 95.2 (15.) 106.3 (13.)
 Trefferlage 0.48 mm links, 0.47 mm tief
 Streuwert 1.34, horizontal: 1.62, vertikal: 0.99

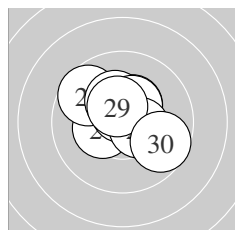

Serie 3:
 10.3 * 9.7 ↖ 10.4 * 10.3 * 10.6 *
 10.7 * 10.4 * 10.4 * 10.5 * 9.7 ↘
 beste Teiler 73.5 (26.) 77.4 (25.) 122.3 (29.)
 Trefferlage 0.10 mm rechts, 0.60 mm hoch
 Streuwert 1.30, horizontal: 1.49, vertikal: 1.07

Unterschrift des Schützen

Meyton Elektronik

Ergebnis: **310.2** (298)
 Serien: 103.7 102.6 103.9
 Zähler: 28 2 0 0 0 0 0 0 0 0
 Innenzehner: 23
 weiteste: 299 (17), 269 (13), 248 (30)
 beste Teiler 12.0 (19.) 42.7 (28.) 51.6 (21.)
 Trefferlage 0.06 mm rechts, 0.67 mm tief
 Streuwert 1.10, horizontal: 1.31, vertikal: 0.85

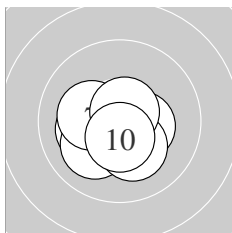
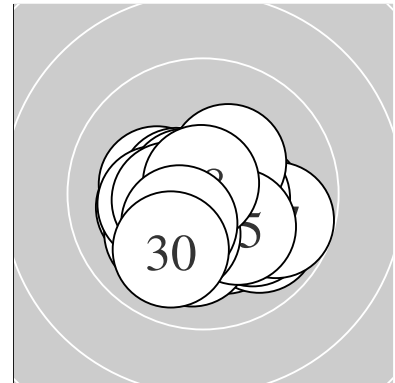

Serie 1:
 10.3 * 10.5 * 10.4 * 10.6 * 10.2 *
 10.1 ↙ 10.2 * 10.2 * 10.7 * 10.5 *
 beste Teiler 68.0 (9.) 100.1 (4.) 104.0 (10.)
 Trefferlage 0.38 mm links, 0.62 mm tief
 Streuwert 1.00, horizontal: 1.18, vertikal: 0.77

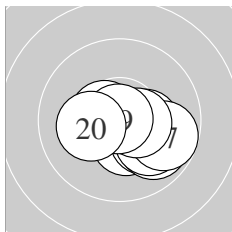

Serie 2:
 10.4 * 10.1 ↘ 9.9 ↘ 10.5 * 10.0 ↘
 10.3 * 9.8 ↘ 10.5 * 10.9 * 10.2 *
 beste Teiler 12.0 (19.) 101.8 (14.) 113.4 (18.)
 Trefferlage 0.88 mm rechts, 0.69 mm tief
 Streuwert 1.15, horizontal: 1.48, vertikal: 0.68

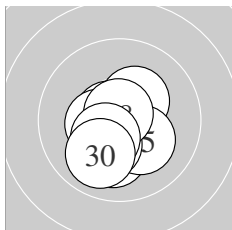

Serie 3:
 10.7 * 10.7 * 10.1 ↓ 10.3 * 10.2 *
 10.3 * 10.4 * 10.8 * 10.4 * 10.0 ↙
 beste Teiler 42.7 (28.) 51.6 (21.) 72.6 (22.)
 Trefferlage 0.30 mm links, 0.70 mm tief
 Streuwert 1.02, horizontal: 0.89, vertikal: 1.13

Unterschrift des Schützen

Ergebnis: **309.8** (296)
 Serien: 104.7 102.8 102.3
 Zähler: 26 4 0 0 0 0 0 0 0 0
 Innenzehner: 22
 weiteste: 341 (16), 314 (29), 274 (14)
 beste Teiler 33.0 (5.) 46.2 (17.) 48.2 (7.)
 Trefferlage 0.61 mm links, 0.09 mm hoch
 Streuwert 1.20, horizontal: 1.04, vertikal: 1.34

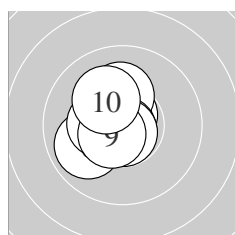
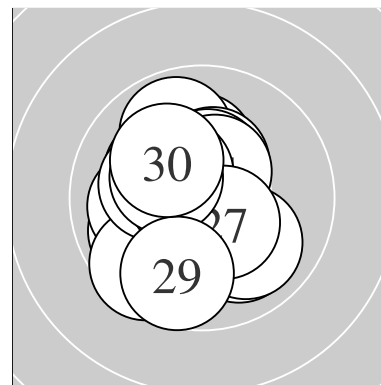

Serie 1:
 10.7 * 10.3 * 10.8 * 10.2 * 10.8 *
 9.9 ↙ 10.8 * 10.4 * 10.6 * 10.2 *
 beste Teiler 33.0 (5.) 48.2 (7.) 50.4 (3.)
 Trefferlage 0.73 mm links, 0.13 mm hoch
 Streuwert 0.94, horizontal: 0.81, vertikal: 1.05

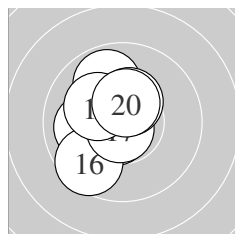

Serie 2:
 10.5 * 10.6 * 10.4 * 9.9 ↗ 10.0 ←
 9.6 ↘ 10.8 * 10.2 * 10.4 * 10.4 *
 beste Teiler 46.2 (17.) 77.0 (12.) 113.0 (11.)
 Trefferlage 0.82 mm links, 0.42 mm hoch
 Streuwert 1.24, horizontal: 0.98, vertikal: 1.45

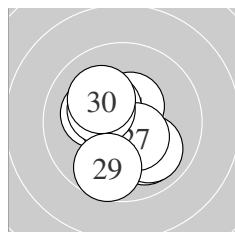

Serie 3:
 10.2 * 10.0 ↘ 10.7 * 10.5 * 10.4 *
 10.0 ↘ 10.4 * 10.3 * 9.7 ↓ 10.1 ↖
 beste Teiler 66.4 (23.) 116.7 (24.) 128.3 (27.)
 Trefferlage 0.27 mm links, 0.26 mm tief
 Streuwert 1.42, horizontal: 1.30, vertikal: 1.53

Unterschrift des Schützen

Meyton Elektronik

Ergebnis: **303.0** (290)
 Serien: 101.9 100.5 100.6
 Zähler: 21 8 1 0 0 0 0 0 0 0
 Innenzehner: 14
 weiteste: 593 (17), 351 (15), 348 (30)
 beste Teiler 11.0 (26.) 57.3 (5.) 82.7 (12.)
 Trefferlage 0.52 mm links, 0.78 mm hoch
 Streuwert 1.58, horizontal: 1.76, vertikal: 1.39

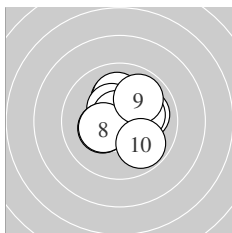
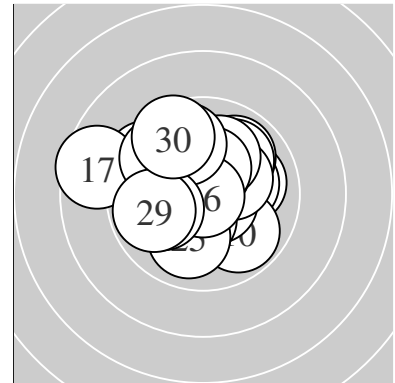

Serie 1:
 10.2 * 10.1 ↑ 10.0 → 10.4 * 10.7 *
 10.2 * 10.3 * 10.3 * 9.9 ↗ 9.8 ↘
 beste Teiler 57.3 (5.) 136.5 (4.) 158.0 (8.)
 Trefferlage 0.32 mm rechts, 0.57 mm hoch
 Streuwert 1.41, horizontal: 1.47, vertikal: 1.35

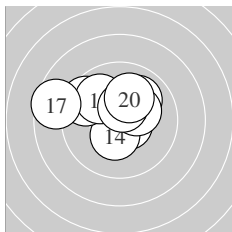

Serie 2:
 10.6 * 10.6 * 10.0 ↗ 10.4 * 9.5 ↘
 9.9 ↘ 8.6 ← 10.3 * 10.5 * 10.1 ↑
 beste Teiler 82.7 (12.) 83.8 (11.) 119.1 (19.)
 Trefferlage 0.61 mm links, 0.99 mm hoch
 Streuwert 1.81, horizontal: 2.32, vertikal: 1.11

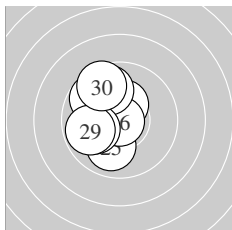

Serie 3:
 10.1 ↘ 10.2 * 9.8 ↘ 10.4 * 10.0 ↓
 10.9 * 9.8 ↘ 10.0 ← 9.8 ← 9.6 ↘
 beste Teiler 11.0 (26.) 144.8 (24.) 195.4 (22.)
 Trefferlage 1.27 mm links, 0.77 mm hoch
 Streuwert 1.43, horizontal: 1.00, vertikal: 1.75

Unterschrift des Schützen

Ergebnis: **301.6** (290)
 Serien: 100.5 100.1 101.0
 Zähler: 20 10 0 0 0 0 0 0 0 0
 Innenzehner: 12
 weiteste: 420 (21), 364 (2), 360 (26)
 beste Teiler 75.6 (29.) 87.4 (22.) 115.2 (17.)
 Trefferlage 0.94 mm links, 1.00 mm hoch
 Streuwert 1.45, horizontal: 1.86, vertikal: 0.85

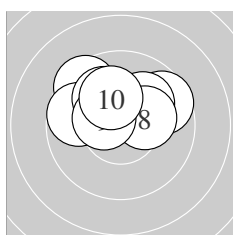
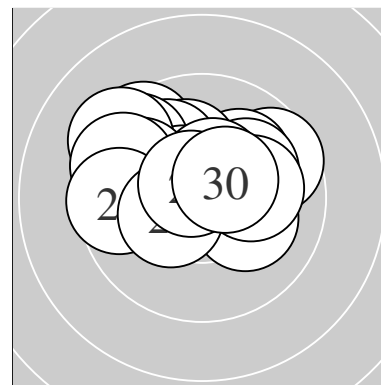

Serie 1:
 10.3 * 9.5 ↘ 9.7 ← 9.6 ↗ 10.1 ↗
 10.1 ↘ 10.5 * 10.2 * 10.4 * 10.1 ↖
 beste Teiler 120.2 (7.) 127.2 (9.) 167.4 (1.)
 Trefferlage 0.40 mm links, 1.35 mm hoch
 Streuwert 1.42, horizontal: 1.89, vertikal: 0.70

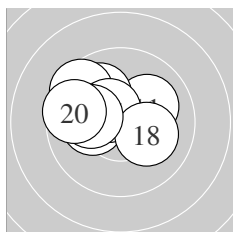

Serie 2:
 10.1 ↗ 10.2 * 9.8 ↘ 10.2 * 10.0 ↘
 9.5 ↘ 10.5 * 10.1 ↘ 10.1 ← 9.6 ←
 beste Teiler 115.2 (17.) 186.1 (14.) 196.2 (12.)
 Trefferlage 1.25 mm links, 0.91 mm hoch
 Streuwert 1.42, horizontal: 1.77, vertikal: 0.94

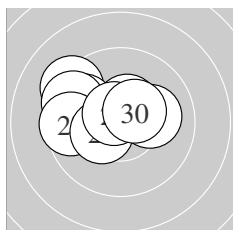

Serie 3:
 9.3 ↘ 10.6 * 9.8 ↘ 10.5 * 10.1 →
 9.5 ↘ 9.6 ← 10.4 * 10.7 * 10.5 *
 beste Teiler 75.6 (29.) 87.4 (22.) 122.0 (24.)
 Trefferlage 1.18 mm links, 0.75 mm hoch
 Streuwert 1.54, horizontal: 2.00, vertikal: 0.85

Unterschrift des Schützen

Meyton Elektronik

Ergebnis: **301.2** (289)
 Serien: 101.2 98.1 101.9
 Zähler: 21 7 2 0 0 0 0 0 0 0
 Innenzehner: 14
 weiteste: 529 (18), 528 (28), 500 (13)
 beste Teiler 7.0 (4.) 31.7 (26.) 56.7 (21.)
 Trefferlage 0.81 mm links, 0.37 mm tief
 Streuwert 1.82, horizontal: 2.15, vertikal: 1.42

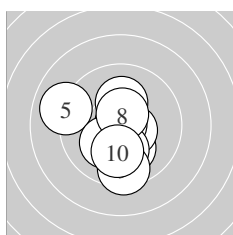
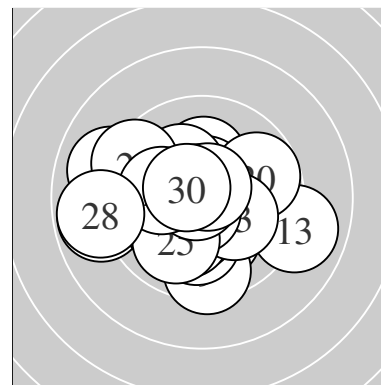

Serie 1:
 10.2 * 10.1 ↘ 10.5 * 10.9 * 9.0 ↖
 10.1 ↓ 10.2 * 10.6 * 9.5 ↓ 10.1 ↓
 beste Teiler 7.0 (4.) 95.1 (8.) 101.0 (3.)
 Trefferlage 0.38 mm links, 0.75 mm tief
 Streuwert 1.73, horizontal: 1.63, vertikal: 1.84

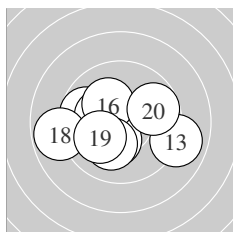

Serie 2:
 10.0 ↖ 9.7 ↖ 9.0 → 10.2 * 10.3 *
 10.2 * 10.1 ↓ 8.8 ← 10.1 ↙ 9.7 →
 beste Teiler 159.2 (15.) 180.8 (14.) 188.3 (16.)
 Trefferlage 0.88 mm links, 0.29 mm tief
 Streuwert 2.20, horizontal: 2.84, vertikal: 1.29

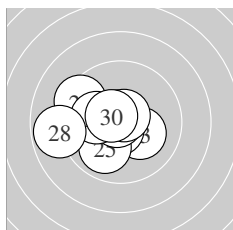

Serie 3:
 10.7 * 9.4 ↖ 10.2 * 10.7 * 9.9 ↙
 10.8 * 10.1 ↖ 8.8 ← 10.7 * 10.6 *
 beste Teiler 31.7 (26.) 56.7 (21.) 63.0 (29.)
 Trefferlage 1.17 mm links, 0.07 mm tief
 Streuwert 1.60, horizontal: 1.98, vertikal: 1.09

Unterschrift des Schützen

Meyton Elektronik

Ergebnis: **305.1** (290)
 Serien: 102.6 102.6 99.9
 Zähler: 20 10 0 0 0 0 0 0 0 0
 Innenzehner: 15
 weiteste: 392 (13), 362 (24), 314 (29)
 beste Teiler 40.0 (21.) 54.4 (18.) 76.2 (14.)
 Trefferlage 0.50 mm links, 1.07 mm tief
 Streuwert 1.32, horizontal: 1.59, vertikal: 0.98

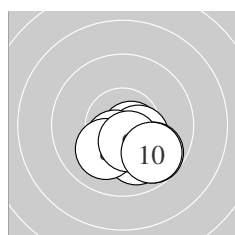
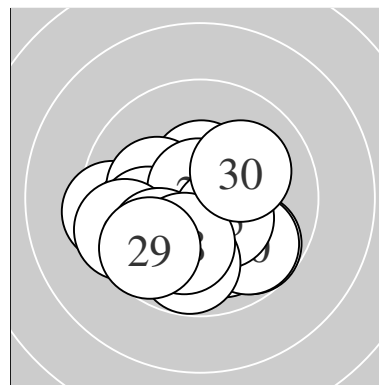

Serie 1:
 10.6 * 10.5 * 10.6 * 10.4 * 10.0 ↘
 9.7 ↘ 10.5 * 10.1 ↗ 10.4 * 9.8 ↘
 beste Teiler 79.2 (3.) 99.0 (1.) 122.0 (2.)
 Trefferlage 0.70 mm rechts, 1.34 mm tief
 Streuwert 0.87, horizontal: 1.07, vertikal: 0.61

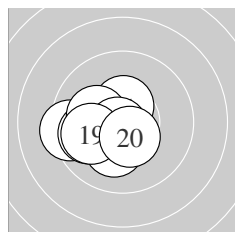

Serie 2:
 10.5 * 10.6 * 9.4 ← 10.6 * 10.2 *
 9.9 ← 10.2 * 10.7 * 10.0 ← 10.5 *
 beste Teiler 54.4 (18.) 76.2 (14.) 94.3 (12.)
 Trefferlage 1.19 mm links, 0.52 mm tief
 Streuwert 1.15, horizontal: 1.39, vertikal: 0.83

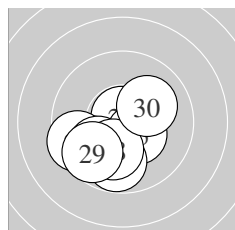

Serie 3:
 10.8 * 9.8 ↙ 9.8 ↙ 9.5 ← 10.4 *
 9.8 ↓ 9.9 ↙ 10.1 ↓ 9.7 ↙ 10.1 ↗
 beste Teiler 40.0 (21.) 136.1 (25.) 213.7 (28.)
 Trefferlage 1.02 mm links, 1.34 mm tief
 Streuwert 1.45, horizontal: 1.63, vertikal: 1.25

Unterschrift des Schützen

Ergebnis: **301.5** (288)
 Serien: 100.3 100.1 101.1
 Zähler: 18 12 0 0 0 0 0 0 0 0
 Innenzehner: 12
 weiteste: 466 (26), 462 (27), 404 (9)
 beste Teiler 35.6 (30.) 37.8 (11.) 69.8 (8.)
 Trefferlage 0.36 mm rechts, 0.98 mm tief
 Streuwert 1.65, horizontal: 1.70, vertikal: 1.59

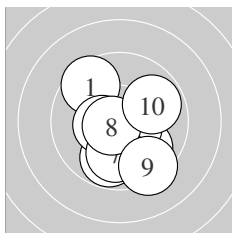
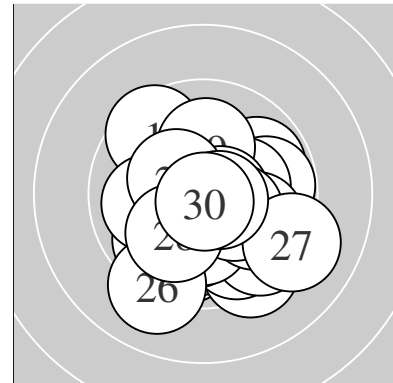

Serie 1:
 9.5 ↘ 9.8 ↓ 9.9 ↘ 10.4 * 10.4 *
 10.5 * 10.0 ↓ 10.7 * 9.3 ↘ 9.8 ↗
 beste Teiler 69.8 (8.) 110.1 (6.) 126.5 (4.)
 Trefferlage 0.27 mm rechts, 0.88 mm tief
 Streuwert 1.74, horizontal: 1.58, vertikal: 1.89

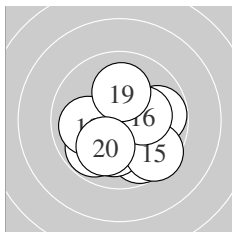

Serie 2:
 10.8 * 9.8 ↘ 10.1 ↓ 9.8 → 9.5 ↘
 10.2 * 9.8 ↙ 10.0 ← 10.1 ↑ 10.0 ↙
 beste Teiler 37.8 (11.) 180.4 (16.) 211.2 (13.)
 Trefferlage 0.35 mm rechts, 0.86 mm tief
 Streuwert 1.72, horizontal: 1.84, vertikal: 1.59

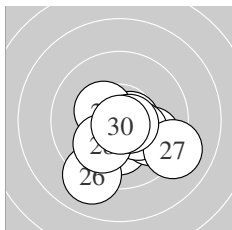

Serie 3:
 10.2 * 10.6 * 10.4 * 9.9 ↘ 10.3 *
 9.1 ↓ 9.1 ↘ 10.1 ↙ 10.6 * 10.8 *
 beste Teiler 35.6 (30.) 78.1 (29.) 80.2 (22.)
 Trefferlage 0.47 mm rechts, 1.21 mm tief
 Streuwert 1.64, horizontal: 1.85, vertikal: 1.39

Unterschrift des Schützen

Ergebnis: **304.4** (293)
 Serien: 103.3 102.1 99.0
 Zähler: 24 5 1 0 0 0 0 0 0 0
 Innenzehner: 18
 weiteste: 694 (28), 364 (22), 354 (15)
 beste Teiler 19.1 (1.) 34.0 (19.) 86.3 (16.)
 Trefferlage 0.02 mm links, 0.80 mm hoch
 Streuwert 1.60, horizontal: 1.90, vertikal: 1.24

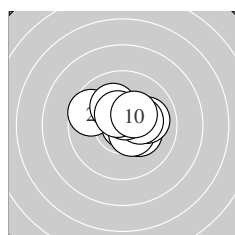
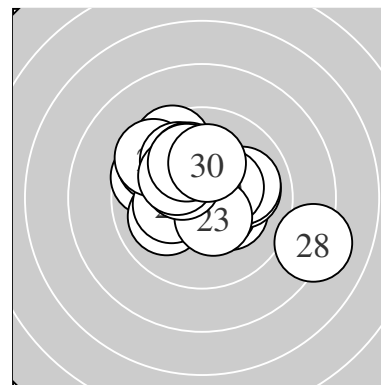

Serie 1:
 10.9 * 9.6 ↖ 10.2 * 10.3 * 10.5 *
 10.0 → 10.3 * 10.6 * 10.5 * 10.4 *
 beste Teiler 19.1 (1.) 86.6 (8.) 115.6 (5.)
 Trefferlage 0.35 mm rechts, 0.52 mm hoch
 Streuwert 1.25, horizontal: 1.55, vertikal: 0.84

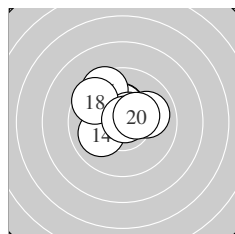

Serie 2:
 10.3 * 10.5 * 10.4 * 10.0 ↙ 9.5 ↖
 10.6 * 10.0 → 9.6 ↖ 10.8 * 10.4 *
 beste Teiler 34.0 (19.) 86.3 (16.) 110.4 (12.)
 Trefferlage 0.15 mm links, 1.01 mm hoch
 Streuwert 1.36, horizontal: 1.57, vertikal: 1.12

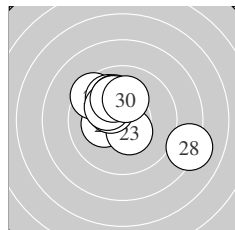

Serie 3:
 10.2 * 9.5 ↖ 10.4 * 9.9 ↖ 10.4 *
 10.0 ↖ 10.2 * 8.2 ↘ 10.1 ↖ 10.1 ↑
 beste Teiler 127.7 (23.) 150.3 (25.) 179.8 (21.)
 Trefferlage 0.28 mm links, 0.88 mm hoch
 Streuwert 2.17, horizontal: 2.56, vertikal: 1.69

Unterschrift des Schützen

Meyton Elektronik

Ergebnis: **303.6** (291)
 Serien: 99.8 100.6 103.2
 Zähler: 21 9 0 0 0 0 0 0 0 0
 Innenzehner: 16
 weiteste: 408 (8), 407 (16), 385 (5)
 beste Teiler 42.7 (28.) 58.7 (19.) 72.3 (13.)
 Trefferlage 0.85 mm links, 0.60 mm hoch
 Streuwert 1.51, horizontal: 1.88, vertikal: 1.01

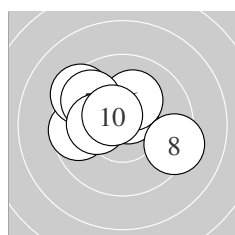
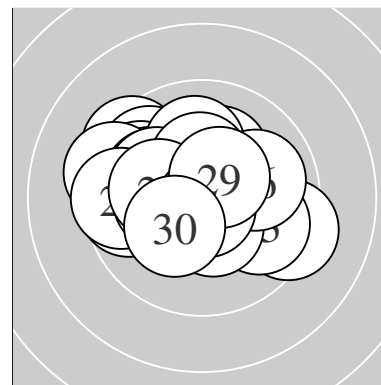

Serie 1:
 10.4 * 9.8 ↖ 10.6 * 9.6 ← 9.4 ↗
 10.2 * 9.8 ↖ 9.3 → 10.2 * 10.5 *
 beste Teiler 95.2 (3.) 106.1 (10.) 146.9 (1.)
 Trefferlage 0.98 mm links, 0.84 mm hoch
 Streuwert 1.75, horizontal: 2.19, vertikal: 1.14

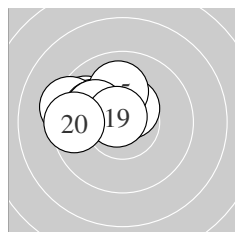

Serie 2:
 9.8 ↖ 10.0 ↖ 10.7 * 10.5 * 10.0 ↑
 9.3 ↖ 10.0 ↖ 10.1 ↖ 10.7 * 9.5 ←
 beste Teiler 58.7 (19.) 72.3 (13.) 113.5 (14.)
 Trefferlage 1.69 mm links, 0.93 mm hoch
 Streuwert 1.16, horizontal: 1.53, vertikal: 0.60

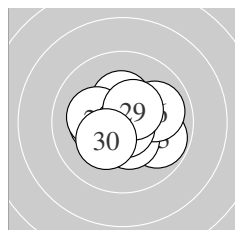

Serie 3:
 10.6 * 10.3 * 9.8 ↗ 10.3 * 10.4 *
 10.0 → 10.2 * 10.8 * 10.5 * 10.3 *
 beste Teiler 42.7 (28.) 100.4 (21.) 119.2 (29.)
 Trefferlage 0.13 mm rechts, 0.04 mm hoch
 Streuwert 1.30, horizontal: 1.52, vertikal: 1.04

Unterschrift des Schützen

Ergebnis: **303.6** (288)
 Serien: 100.7 101.9 101.0
 Zähler: 18 12 0 0 0 0 0 0 0 0
 Innenzehner: 14
 weiteste: 345 (2), 323 (17), 320 (15)
 beste Teiler 31.1 (13.) 37.5 (6.) 82.5 (18.)
 Trefferlage 0.95 mm links, 0.81 mm tief
 Streuwert 1.37, horizontal: 1.19, vertikal: 1.53

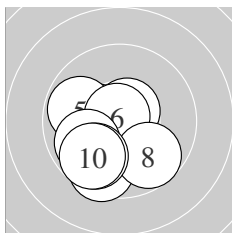
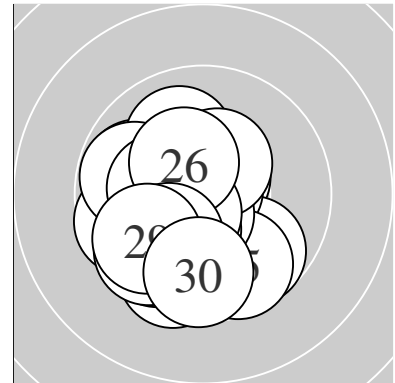

Serie 1:
 10.4 * 9.6 ↘ 10.4 * 10.6 * 9.8 ↖
 10.8 * 9.9 ↙ 9.7 ↘ 9.8 ✓ 9.7 ✓
 beste Teiler 37.5 (6.) 85.8 (4.) 143.0 (1.)
 Trefferlage 0.88 mm links, 1.10 mm tief
 Streuwert 1.46, horizontal: 1.42, vertikal: 1.50

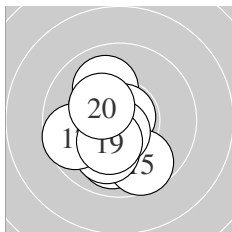

Serie 2:
 10.0 ↖ 10.4 * 10.8 * 10.0 ↓ 9.7 ↘
 10.1 ↓ 9.7 ↖ 10.6 * 10.3 * 10.3 *
 beste Teiler 31.1 (13.) 82.5 (18.) 145.6 (12.)
 Trefferlage 0.70 mm links, 0.66 mm tief
 Streuwert 1.41, horizontal: 1.15, vertikal: 1.64

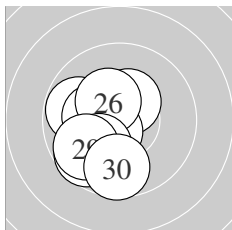

Serie 3:
 10.4 * 9.8 ↖ 10.4 * 10.5 * 10.3 *
 10.4 * 10.0 ✓ 9.7 ✓ 9.8 ✓ 9.7 ↓
 beste Teiler 102.0 (24.) 137.8 (23.) 138.9 (21.)
 Trefferlage 1.28 mm links, 0.67 mm tief
 Streuwert 1.33, horizontal: 1.04, vertikal: 1.56

Unterschrift des Schützen

Ergebnis: **301.8** (288)
 Serien: 97.6 101.1 103.1
 Zähler: 19 10 1 0 0 0 0 0 0 0
 Innenzehner: 12
 weiteste: 541 (5), 397 (2), 390 (20)
 beste Teiler 10.0 (14.) 46.1 (24.) 65.0 (28.)
 Trefferlage 0.05 mm rechts, 0.80 mm tief
 Streuwert 1.73, horizontal: 2.13, vertikal: 1.20

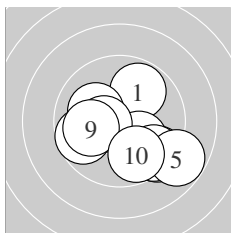
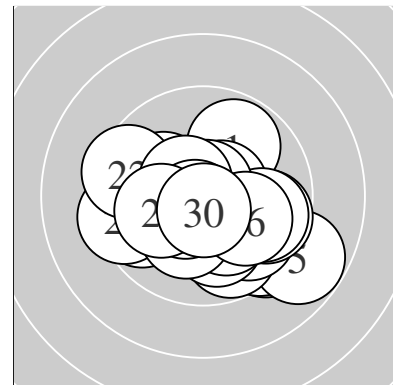

Serie 1:
 9.8 ↗ 9.4 ↘ 10.1 ↘ 9.5 ↘ 8.8 ↘
 9.7 ← 10.1 ← 10.4 * 10.0 ← 9.8 ↘
 beste Teiler 126.9 (8.) 206.9 (7.) 212.2 (3.)
 Trefferlage 0.62 mm rechts, 1.09 mm tief
 Streuwert 2.18, horizontal: 2.55, vertikal: 1.73

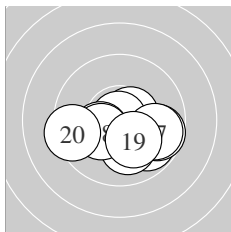

Serie 2:
 10.6 * 9.8 ↘ 9.7 ↘ 10.9 * 10.3 *
 10.1 ↓ 9.8 ↘ 10.3 * 10.2 * 9.4 ←
 beste Teiler 10.0 (14.) 95.2 (11.) 172.5 (18.)
 Trefferlage 0.37 mm rechts, 0.96 mm tief
 Streuwert 1.61, horizontal: 2.14, vertikal: 0.77

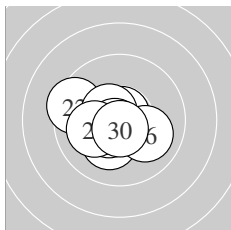

Serie 3:
 10.1 ← 9.5 ← 10.2 * 10.8 * 10.5 *
 10.0 ↘ 10.5 * 10.7 * 10.1 ← 10.7 *
 beste Teiler 46.1 (24.) 65.0 (28.) 69.1 (30.)
 Trefferlage 0.82 mm links, 0.37 mm tief
 Streuwert 1.23, horizontal: 1.50, vertikal: 0.86

Unterschrift des Schützen

Ergebnis: **308.3** (294)
 Serien: 102.4 101.7 104.2
 Zähler: 24 6 0 0 0 0 0 0 0 0
 Innenzehner: 19
 weiteste: 371 (6), 371 (13), 348 (15)
 beste Teiler 37.0 (28.) 53.7 (11.) 61.0 (30.)
 Trefferlage 0.48 mm rechts, 0.83 mm hoch
 Streuwert 1.19, horizontal: 1.34, vertikal: 1.03

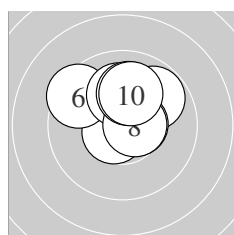
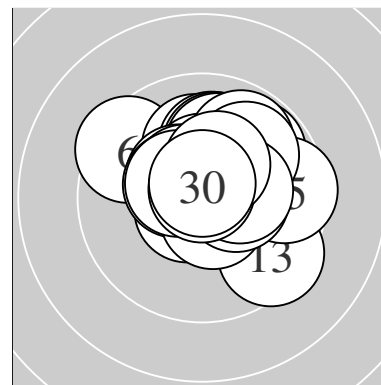

Serie 1:
 9.8 ↗ 10.7 * 10.5 * 10.6 * 10.6 *
 9.5 ↘ 10.1 ↑ 10.6 * 10.0 ↑ 10.0 ↑
 beste Teiler 69.1 (2.) 77.0 (4.) 86.0 (8.)
 Trefferlage 0.10 mm rechts, 1.19 mm hoch
 Streuwert 1.21, horizontal: 1.36, vertikal: 1.04

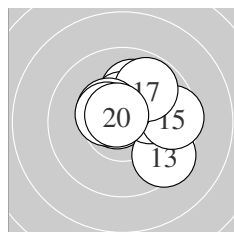

Serie 2:
 10.7 * 10.0 ↑ 9.5 ↘ 10.1 → 9.6 →
 10.4 * 9.8 ↗ 10.4 * 10.5 * 10.7 *
 beste Teiler 53.7 (11.) 65.2 (20.) 123.0 (19.)
 Trefferlage 0.77 mm rechts, 0.68 mm hoch
 Streuwert 1.46, horizontal: 1.63, vertikal: 1.27

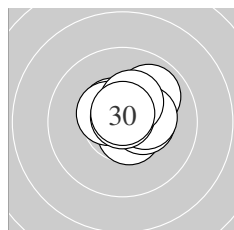

Serie 3:
 10.2 * 10.5 * 10.6 * 9.9 ↗ 10.5 *
 10.4 * 10.3 * 10.8 * 10.3 * 10.7 *
 beste Teiler 37.0 (28.) 61.0 (30.) 87.9 (23.)
 Trefferlage 0.56 mm rechts, 0.63 mm hoch
 Streuwert 0.87, horizontal: 0.99, vertikal: 0.73

Unterschrift des Schützen

Meyton Elektronik

Ergebnis: **311.0** (297)
 Serien: 103.2 103.9 103.9
 Zähler: 27 3 0 0 0 0 0 0 0 0
 Innenzehner: 21
 weiteste: 334 (24), 270 (7), 266 (1)
 beste Teiler 8.0 (2.) 21.0 (30.) 30.2 (29.)
 Trefferlage 0.14 mm rechts, 0.02 mm hoch
 Streuwert 1.21, horizontal: 1.31, vertikal: 1.11

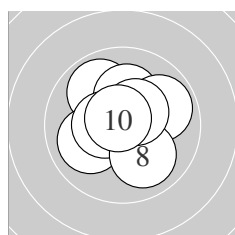
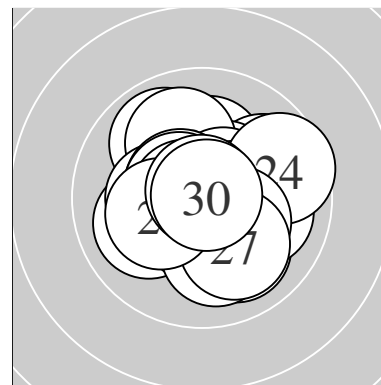

Serie 1:
 9.9 ↖ 10.9 * 10.6 * 10.0 ↙ 10.2 *
 10.5 * 9.9 → 10.0 ↘ 10.5 * 10.7 *
 beste Teiler 8.0 (2.) 55.4 (10.) 82.0 (3.)
 Trefferlage 0.01 mm links, 0.43 mm hoch
 Streuwert 1.32, horizontal: 1.38, vertikal: 1.26

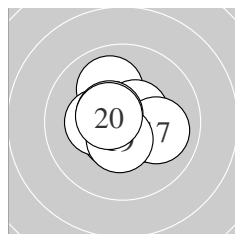

Serie 2:
 10.7 * 10.6 * 10.0 ↖ 10.2 * 10.3 *
 10.5 * 10.0 → 10.5 * 10.5 * 10.6 *
 beste Teiler 72.8 (11.) 98.1 (12.) 100.7 (20.)
 Trefferlage 0.06 mm links, 0.02 mm hoch
 Streuwert 1.14, horizontal: 1.28, vertikal: 0.97

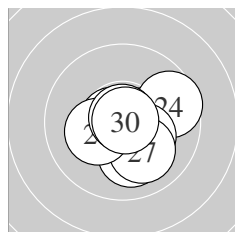

Serie 3:
 10.5 * 10.8 * 10.1 ↓ 9.6 → 10.7 *
 10.3 * 10.0 ↘ 10.2 * 10.8 * 10.9 *
 beste Teiler 21.0 (30.) 30.2 (29.) 36.4 (22.)
 Trefferlage 0.50 mm rechts, 0.38 mm tief
 Streuwert 1.18, horizontal: 1.33, vertikal: 1.02

Unterschrift des Schützen

Meyton Elektronik

Ergebnis: **311.6** (297)
 Serien: 104.4 103.6 103.6
 Zähler: 27 3 0 0 0 0 0 0 0 0
 Innenzehner: 25
 weiteste: 402 (3), 363 (13), 338 (25)
 beste Teiler 46.8 (9.) 57.0 (18.) 62.0 (1.)
 Trefferlage 0.76 mm links, 0.35 mm tief
 Streuwert 1.05, horizontal: 1.21, vertikal: 0.87

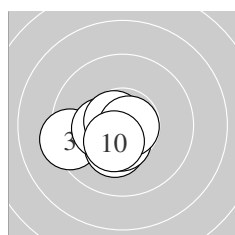
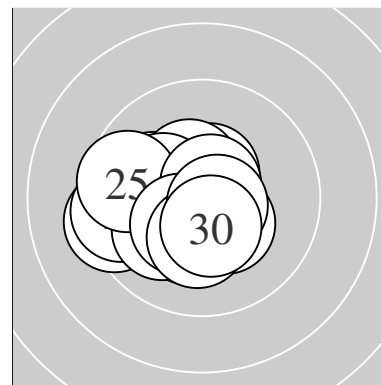

Serie 1:
 10.7 * 10.7 * 9.3 ← 10.7 * 10.3 *
 10.3 * 10.7 * 10.5 * 10.8 * 10.4 *
 beste Teiler 46.8 (9.) 62.0 (1.) 67.4 (4.)
 Trefferlage 0.76 mm links, 0.68 mm tief
 Streuwert 0.95, horizontal: 1.21, vertikal: 0.58

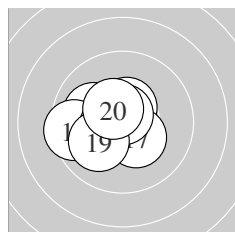

Serie 2:
 10.1 ↖ 10.5 * 9.5 ← 10.5 * 10.7 *
 10.6 * 10.4 * 10.7 * 10.1 ↙ 10.5 *
 beste Teiler 57.0 (18.) 68.3 (15.) 95.8 (16.)
 Trefferlage 0.96 mm links, 0.03 mm tief
 Streuwert 1.11, horizontal: 1.32, vertikal: 0.85

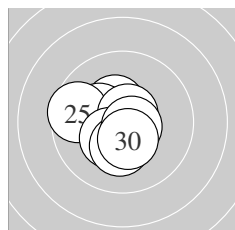

Serie 3:
 10.4 * 10.5 * 10.5 * 10.2 * 9.6 ←
 10.7 * 10.4 * 10.2 * 10.7 * 10.4 *
 beste Teiler 68.5 (26.) 74.6 (29.) 116.7 (23.)
 Trefferlage 0.58 mm links, 0.35 mm tief
 Streuwert 1.13, horizontal: 1.20, vertikal: 1.06

Unterschrift des Schützen

Meyton Elektronik

Ergebnis: **306.0** (293)
 Serien: 100.1 103.7 102.2
 Zähler: 23 7 0 0 0 0 0 0 0 0
 Innenzehner: 18
 weiteste: 385 (3), 324 (2), 322 (25)
 beste Teiler 72.1 (16.) 83.2 (8.) 85.1 (28.)
 Trefferlage 0.72 mm links, 0.09 mm tief
 Streuwert 1.38, horizontal: 1.38, vertikal: 1.38

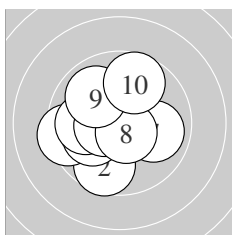
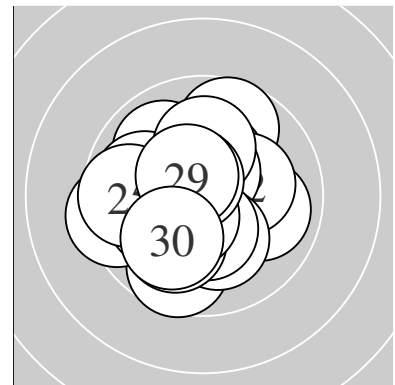

Serie 1:
 10.3 * 9.7 ↙ 9.4 ← 10.1 ← 10.0 ←
 10.5 * 9.9 → 10.6 * 9.9 ↘ 9.7 ↑
 beste Teiler 83.2 (8.) 110.4 (6.) 171.3 (1.)
 Trefferlage 0.87 mm links, 0.29 mm tief
 Streuwert 1.75, horizontal: 1.81, vertikal: 1.68

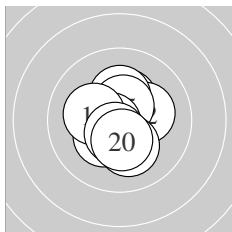

Serie 2:
 10.3 * 10.2 * 10.3 * 10.3 * 10.5 *
 10.7 * 10.2 * 10.2 * 10.6 * 10.4 *
 beste Teiler 72.1 (16.) 100.5 (19.) 107.2 (15.)
 Trefferlage 0.06 mm links, 0.04 mm tief
 Streuwert 1.15, horizontal: 1.01, vertikal: 1.27

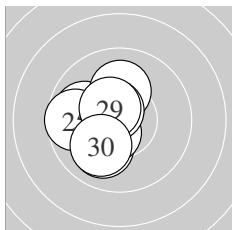

Serie 3:
 10.3 * 10.6 * 9.9 ← 10.1 ↑ 9.7 ←
 10.0 ↙ 10.5 * 10.6 * 10.5 * 10.0 ↘
 beste Teiler 85.1 (28.) 93.8 (22.) 112.4 (27.)
 Trefferlage 1.22 mm links, 0.05 mm hoch
 Streuwert 1.16, horizontal: 1.02, vertikal: 1.28

Unterschrift des Schützen

Ergebnis: **307.5** (294)
 Serien: 102.2 103.5 101.8
 Zähler: 24 6 0 0 0 0 0 0 0 0
 Innenzehner: 20
 weiteste: 350 (6), 336 (20), 331 (29)
 beste Teiler 12.0 (13.) 27.4 (12.) 50.9 (8.)
 Trefferlage 0.35 mm rechts, 0.92 mm tief
 Streuwert 1.23, horizontal: 1.47, vertikal: 0.94

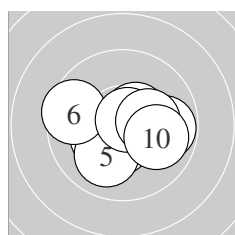
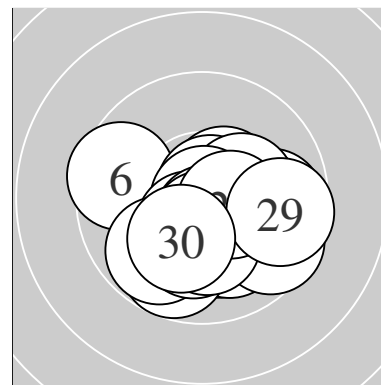

Serie 1:
 10.5 * 10.5 * 10.5 * 10.3 * 10.0 ✓
 9.6 ← 9.8 → 10.8 * 10.2 * 10.0 →
 beste Teiler 50.9 (8.) 101.8 (3.) 115.8 (2.)
 Trefferlage 0.13 mm rechts, 0.35 mm tief
 Streuwert 1.50, horizontal: 1.91, vertikal: 0.94

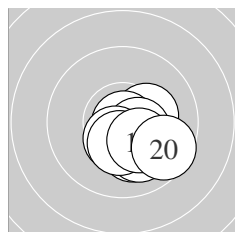

Serie 2:
 10.3 * 10.8 * 10.9 * 10.1 ↓ 10.1 ↓
 10.5 * 10.5 * 10.4 * 10.3 * 9.6 →
 beste Teiler 12.0 (13.) 27.4 (12.) 118.5 (16.)
 Trefferlage 0.79 mm rechts, 0.98 mm tief
 Streuwert 0.92, horizontal: 1.00, vertikal: 0.83

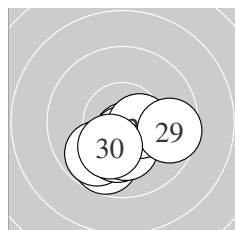

Serie 3:
 10.4 * 9.8 ✓ 10.6 * 9.8 ✓ 10.2 *
 10.5 * 10.2 * 10.5 * 9.6 → 10.2 *
 beste Teiler 90.2 (23.) 111.2 (26.) 121.2 (28.)
 Trefferlage 0.14 mm rechts, 1.43 mm tief
 Streuwert 1.13, horizontal: 1.40, vertikal: 0.77

Unterschrift des Schützen

Meyton Elektronik

Ergebnis: **315.4** (298)
 Serien: 105.0 105.1 105.3
 Zähler: 28 2 0 0 0 0 0 0 0 0
 Innenzehner: 26
 weiteste: 318 (4), 253 (26), 230 (19)
 beste Teiler 23.0 (8.) 27.7 (6.) 28.0 (16.)
 Trefferlage 0.28 mm links, 0.30 mm tief
 Streuwert 0.89, horizontal: 0.92, vertikal: 0.87

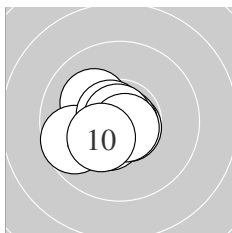
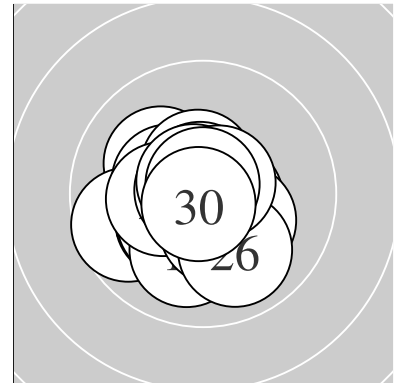

Serie 1:
 10.1 ↖ 10.7 * 10.6 * 9.7 ← 10.5 *
 10.8 * 10.7 * 10.9 * 10.7 * 10.3 *
 beste Teiler 23.0 (8.) 27.7 (6.) 55.4 (9.)
 Trefferlage 0.67 mm links, 0.30 mm tief
 Streuwert 0.92, horizontal: 1.06, vertikal: 0.75

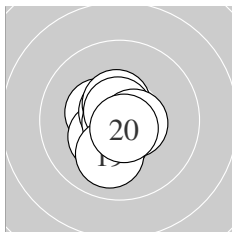

Serie 2:
 10.4 * 10.4 * 10.3 * 10.7 * 10.5 *
 10.8 * 10.7 * 10.6 * 10.0 ↓ 10.7 *
 beste Teiler 28.0 (16.) 60.2 (17.) 61.2 (20.)
 Trefferlage 0.32 mm links, 0.27 mm tief
 Streuwert 0.85, horizontal: 0.65, vertikal: 1.01

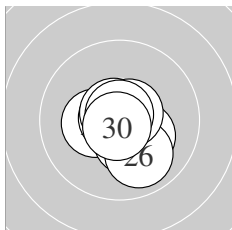

Serie 3:
 10.3 * 10.7 * 10.8 * 10.4 * 10.2 *
 9.9 ↘ 10.7 * 10.7 * 10.8 * 10.8 *
 beste Teiler 38.0 (29.) 43.8 (30.) 48.0 (23.)
 Trefferlage 0.15 mm rechts, 0.33 mm tief
 Streuwert 0.90, horizontal: 0.88, vertikal: 0.92

 Unterschrift des Schützen

Ergebnis: **312.5** (296)
 Serien: 104.6 104.3 103.6
 Zähler: 26 4 0 0 0 0 0 0 0 0
 Innenzehner: 25
 weiteste: 406 (25), 342 (27), 262 (5)
 beste Teiler 7.2 (28.) 42.0 (8.) 49.4 (21.)
 Trefferlage 0.69 mm rechts, 0.11 mm tief
 Streuwert 1.03, horizontal: 1.22, vertikal: 0.79

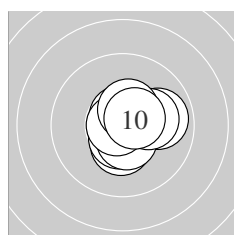
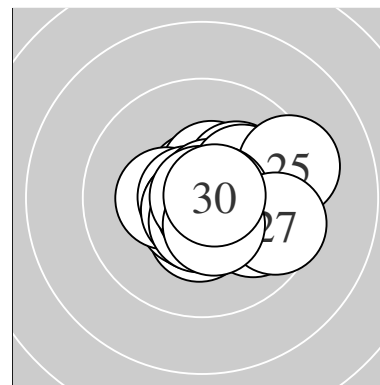

Serie 1:
 10.4 * 10.7 * 10.6 * 10.5 * 9.9 →
 10.5 * 10.2 * 10.8 * 10.5 * 10.5 *
 beste Teiler 42.0 (8.) 68.0 (2.) 99.2 (3.)
 Trefferlage 0.59 mm rechts, 0.03 mm hoch
 Streuwert 0.93, horizontal: 0.99, vertikal: 0.86

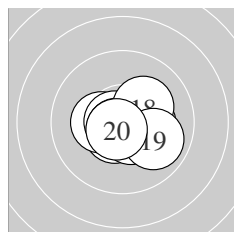

Serie 2:
 10.6 * 10.3 * 10.7 * 10.4 * 10.5 *
 10.3 * 10.7 * 10.2 * 9.9 ↘ 10.7 *
 beste Teiler 59.1 (13.) 63.8 (17.) 68.8 (20.)
 Trefferlage 0.38 mm rechts, 0.28 mm tief
 Streuwert 1.01, horizontal: 1.27, vertikal: 0.65

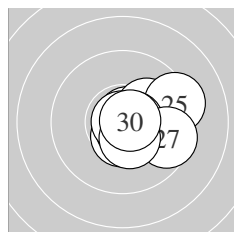

Serie 3:
 10.8 * 10.1 ↗ 10.5 * 10.7 * 9.3 →
 10.6 * 9.6 ↘ 10.9 * 10.4 * 10.7 *
 beste Teiler 7.2 (28.) 49.4 (21.) 56.0 (30.)
 Trefferlage 1.10 mm rechts, 0.09 mm tief
 Streuwert 1.16, horizontal: 1.38, vertikal: 0.88

Unterschrift des Schützen

Meyton Elektronik

Ergebnis: **310.6** (298)
 Serien: 102.2 104.6 103.8
 Zähler: 28 2 0 0 0 0 0 0 0 0
 Innenzehner: 24
 weiteste: 289 (10), 271 (25), 244 (26)
 beste Teiler 6.0 (21.) 46.0 (14.) 72.0 (15.)
 Trefferlage 0.04 mm rechts, 0.39 mm tief
 Streuwert 1.15, horizontal: 1.24, vertikal: 1.06

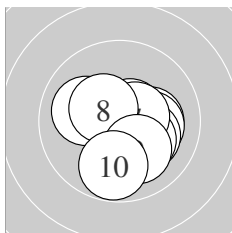
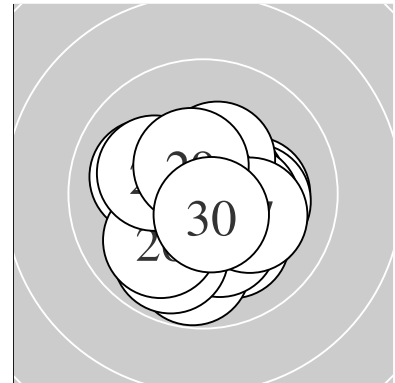

Serie 1:
 10.0 ↖ 10.2 * 10.6 * 10.2 * 10.2 *
 10.2 * 10.5 * 10.4 * 10.1 ↘ 9.8 ↓
 beste Teiler 84.2 (3.) 104.4 (7.) 133.8 (8.)
 Trefferlage 0.61 mm rechts, 0.48 mm tief
 Streuwert 1.30, horizontal: 1.39, vertikal: 1.21

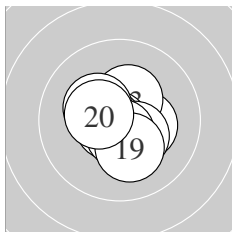

Serie 2:
 10.5 * 10.3 * 10.4 * 10.8 * 10.7 *
 10.3 * 10.4 * 10.6 * 10.2 * 10.4 *
 beste Teiler 46.0 (14.) 72.0 (15.) 88.0 (18.)
 Trefferlage 0.09 mm rechts, 0.29 mm tief
 Streuwert 0.97, horizontal: 1.01, vertikal: 0.92

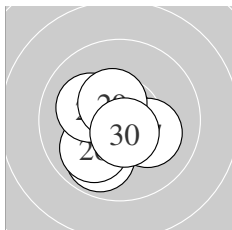

Serie 3:
 10.9 * 10.6 * 10.6 * 10.4 * 9.9 ↙
 10.0 ↗ 10.2 * 10.1 ↖ 10.5 * 10.6 *
 beste Teiler 6.0 (21.) 77.6 (22.) 87.0 (30.)
 Trefferlage 0.57 mm links, 0.40 mm tief
 Streuwert 1.11, horizontal: 1.10, vertikal: 1.12

Unterschrift des Schützen

Ergebnis: **308.3** (296)
 Serien: 103.1 102.3 102.9 0.0
 Zähler: 26 4 0 0 0 0 0 0 0 0
 Innenzehner: 22
 weiteste: 365 (6), 307 (19), 303 (20)
 beste Teiler 34.4 (13.) 77.4 (9.) 91.4 (5.)
 Trefferlage 0.27 mm links, 0.76 mm tief
 Streuwert 1.18, horizontal: 1.19, vertikal: 1.18

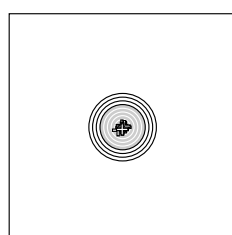
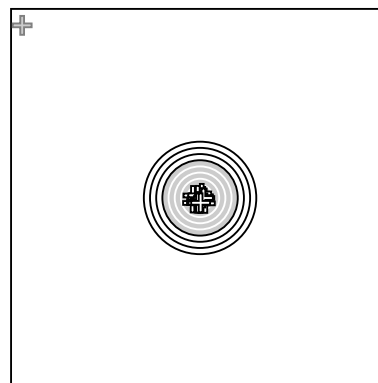

Serie 1:
 10.4 * 10.3 * 10.5 * 10.2 * 10.6 *
 9.5 ↙ 10.4 * 10.3 * 10.6 * 10.3 *
 beste Teiler 77.4 (9.) 91.4 (5.) 115.0 (3.)
 Trefferlage 0.01 mm links, 0.55 mm tief
 Streuwert 1.24, horizontal: 1.38, vertikal: 1.08

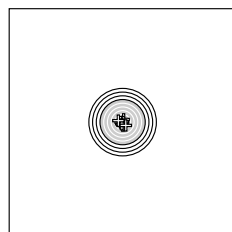

Serie 2:
 10.2 * 10.6 * 10.8 * 10.1 ↓ 10.4 *
 10.4 * 10.1 ↓ 10.3 * 9.7 ↘ 9.7 ↖
 beste Teiler 34.4 (13.) 99.2 (12.) 135.0 (15.)
 Trefferlage 0.30 mm links, 0.66 mm tief
 Streuwert 1.37, horizontal: 1.34, vertikal: 1.40

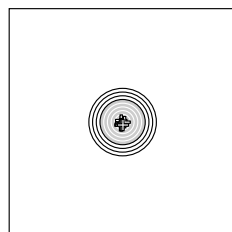

Serie 3:
 10.5 * 9.9 ↙ 10.6 * 10.5 * 10.4 *
 10.2 * 10.4 * 10.1 ↓ 10.1 ↓ 10.2 *
 beste Teiler 92.2 (23.) 104.8 (24.) 121.7 (21.)
 Trefferlage 0.49 mm links, 1.07 mm tief
 Streuwert 0.98, horizontal: 0.84, vertikal: 1.10

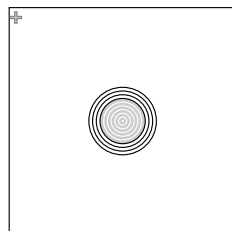

Serie 4:
 0.0+ ↘
AST.NSC
 beste Teiler
 Trefferlage 0.00 mm , 0.00 mm
 Streuwert 0.00, horizontal: 0.00, vertikal: 0.00

AST – Treffer wurde nach Ende der Schießzeit abgegeben
 NSC – Treffer wurde vermessen, geht aber nicht in die Wertung ein

Unterschrift des Schützen

Meyton Elektronik

Ergebnis: **308.3** (297)
 Serien: 103.4 102.9 102.0
 Zähler: 27 3 0 0 0 0 0 0 0 0
 Innenzehner: 21
 weiteste: 378 (27), 274 (10), 272 (23)
 beste Teiler 65.6 (11.) 68.0 (5.) 72.4 (6.)
 Trefferlage 0.22 mm links, 0.21 mm hoch
 Streuwert 1.31, horizontal: 1.29, vertikal: 1.32

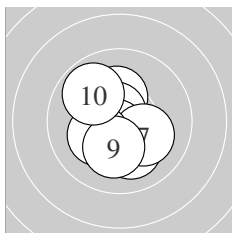
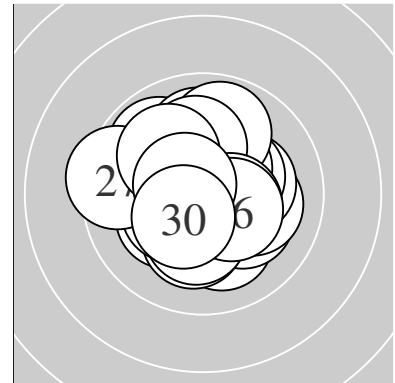

Serie 1:
 10.6 * 10.5 * 10.1 ↓ 10.3 * 10.7 *
 10.7 * 10.2 * 10.2 * 10.2 * 9.9 ↖
 beste Teiler 68.0 (5.) 72.4 (6.) 95.2 (1.)
 Trefferlage 0.24 mm links, 0.39 mm tief
 Streuwert 1.23, horizontal: 1.06, vertikal: 1.38

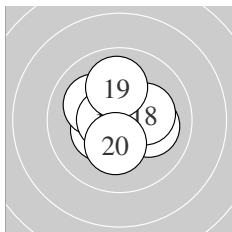

Serie 2:
 10.7 * 10.4 * 10.2 * 10.3 * 10.1 →
 10.1 ↖ 10.6 * 10.2 * 10.0 ↑ 10.3 *
 beste Teiler 65.6 (11.) 88.0 (17.) 149.9 (12.)
 Trefferlage 0.23 mm links, 0.33 mm hoch
 Streuwert 1.28, horizontal: 1.30, vertikal: 1.27

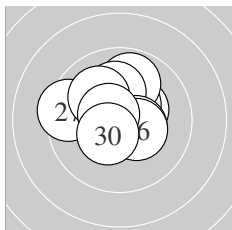

Serie 3:
 10.3 * 10.4 * 9.9 ↑ 10.1 ↑ 10.4 *
 10.4 * 9.4 ← 10.1 ↖ 10.6 * 10.4 *
 beste Teiler 89.8 (29.) 127.9 (25.) 131.8 (30.)
 Trefferlage 0.19 mm links, 0.71 mm hoch
 Streuwert 1.41, horizontal: 1.60, vertikal: 1.19

Unterschrift des Schützen

Ergebnis: **313.1** (298)
 Serien: 103.9 104.6 104.6
 Zähler: 28 2 0 0 0 0 0 0 0 0
 Innenzehner: 26
 weiteste: 290 (8), 263 (24), 220 (4)
 beste Teiler 25.0 (10.) 28.0 (17.) 51.7 (16.)
 Trefferlage 0.12 mm links, 0.13 mm hoch
 Streuwert 1.02, horizontal: 1.18, vertikal: 0.83

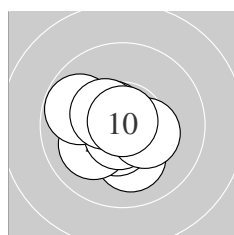
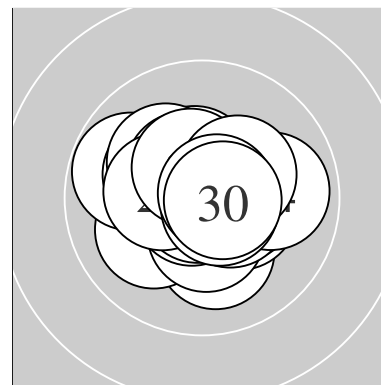

Serie 1:
 10.1 ↓ 10.4 * 10.5 * 10.1 ↙ 10.6 *
 10.7 * 10.4 * 9.8 ↖ 10.4 * 10.9 *
 beste Teiler 25.0 (10.) 62.0 (6.) 90.9 (5.)
 Trefferlage 0.63 mm links, 0.24 mm tief
 Streuwert 1.08, horizontal: 1.19, vertikal: 0.96

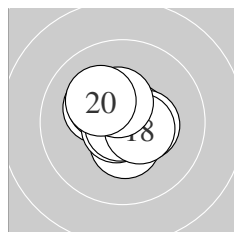

Serie 2:
 10.2 * 10.7 * 10.4 * 10.3 * 10.4 *
 10.7 * 10.8 * 10.5 * 10.4 * 10.2 *
 beste Teiler 28.0 (17.) 51.7 (16.) 72.8 (12.)
 Trefferlage 0.17 mm links, 0.24 mm hoch
 Streuwert 0.97, horizontal: 1.03, vertikal: 0.90

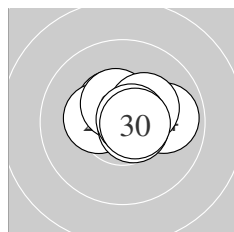

Serie 3:
 10.5 * 10.5 * 10.7 * 9.9 → 10.3 *
 10.5 * 10.6 * 10.3 * 10.7 * 10.6 *
 beste Teiler 54.5 (23.) 58.8 (29.) 76.0 (27.)
 Trefferlage 0.43 mm rechts, 0.41 mm hoch
 Streuwert 0.90, horizontal: 1.18, vertikal: 0.49

 Unterschrift des Schützen

Meyton Elektronik

Ergebnis: **312.0** (298)
 Serien: 103.0 104.5 104.5
 Zähler: 28 2 0 0 0 0 0 0 0 0
 Innenzehner: 25
 weiteste: 413 (13), 369 (9), 222 (14)
 beste Teiler 29.1 (11.) 30.8 (27.) 37.6 (26.)
 Trefferlage 0.31 mm rechts, 0.16 mm hoch
 Streuwert 1.16, horizontal: 1.39, vertikal: 0.86

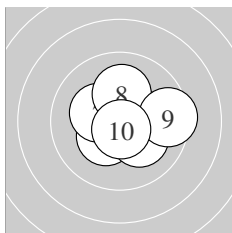
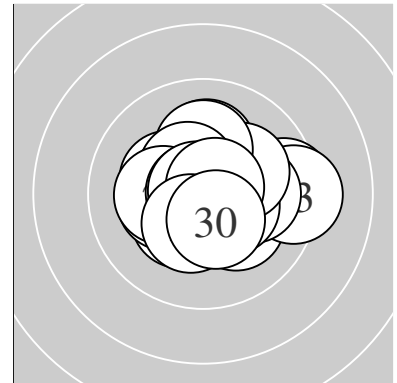

Serie 1:
 10.6 * 10.6 * 10.3 * 10.4 * 10.3 *
 10.2 * 10.3 * 10.1 ↑ 9.5 → 10.7 *
 beste Teiler 63.1 (10.) 83.4 (2.) 95.5 (1.)
 Trefferlage 0.61 mm rechts, 0.07 mm hoch
 Streuwert 1.28, horizontal: 1.47, vertikal: 1.06

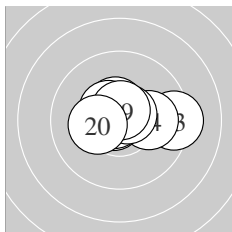

Serie 2:
 10.8 * 10.5 * 9.3 → 10.1 → 10.5 *
 10.8 * 10.8 * 10.7 * 10.7 * 10.3 *
 beste Teiler 29.1 (11.) 41.0 (17.) 46.3 (16.)
 Trefferlage 0.30 mm rechts, 0.27 mm hoch
 Streuwert 1.23, horizontal: 1.68, vertikal: 0.45

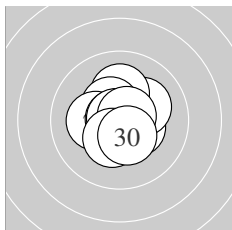

Serie 3:
 10.4 * 10.2 * 10.1 ↑ 10.5 * 10.2 *
 10.8 * 10.8 * 10.7 * 10.4 * 10.4 *
 beste Teiler 30.8 (27.) 37.6 (26.) 62.2 (28.)
 Trefferlage 0.03 mm rechts, 0.15 mm hoch
 Streuwert 1.03, horizontal: 1.02, vertikal: 1.03

Unterschrift des Schützen

Ergebnis: **306.4** (294)
 Serien: 102.6 101.8 102.0
 Zähler: 24 6 0 0 0 0 0 0 0 0
 Innenzehner: 17
 weiteste: 384 (11), 324 (12), 284 (25)
 beste Teiler 37.9 (13.) 50.6 (10.) 66.2 (18.)
 Trefferlage 0.75 mm links, 0.85 mm hoch
 Streuwert 1.19, horizontal: 1.09, vertikal: 1.28

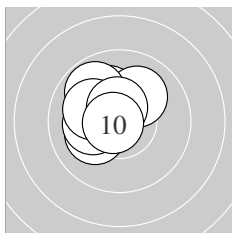
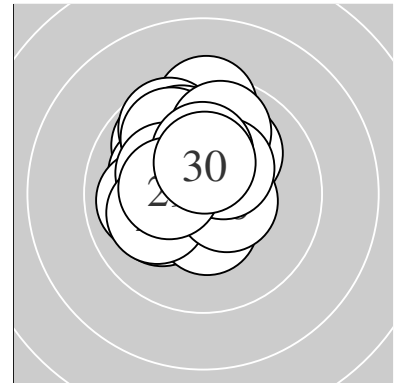

Serie 1:
 10.4 * 10.5 * 10.1 ← 10.1 ↗ 10.2 *
 10.1 ↗ 9.8 ↘ 10.1 ← 10.5 * 10.8 *
 beste Teiler 50.6 (10.) 102.7 (9.) 115.1 (2.)
 Trefferlage 0.95 mm links, 0.80 mm hoch
 Streuwert 1.02, horizontal: 1.03, vertikal: 1.00

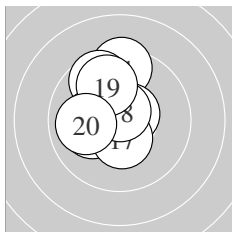

Serie 2:
 9.4 ↑ 9.7 ↘ 10.8 * 10.6 * 10.1 ←
 10.2 * 10.4 * 10.7 * 9.9 ↗ 10.0 ←
 beste Teiler 37.9 (13.) 66.2 (18.) 84.5 (14.)
 Trefferlage 0.78 mm links, 0.85 mm hoch
 Streuwert 1.42, horizontal: 1.12, vertikal: 1.67

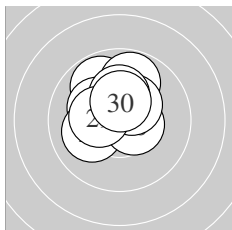

Serie 3:
 9.8 ↘ 10.3 * 10.2 * 10.1 ← 9.8 ↑
 10.5 * 10.4 * 10.2 * 10.3 * 10.4 *
 beste Teiler 109.7 (26.) 138.1 (30.) 144.4 (27.)
 Trefferlage 0.53 mm links, 0.91 mm hoch
 Streuwert 1.21, horizontal: 1.20, vertikal: 1.22

Unterschrift des Schützen

Meyton Elektronik

Ergebnis: **296.7** (286)
 Serien: 100.2 98.3 98.2
 Zähler: 16 14 0 0 0 0 0 0 0 0
 Innenzehner: 11
 weiteste: 467 (9), 459 (27), 457 (29)
 beste Teiler 92.1 (26.) 110.0 (10.) 123.5 (6.)
 Trefferlage 0.30 mm links, 1.02 mm tief
 Streuwert 1.92, horizontal: 2.05, vertikal: 1.77

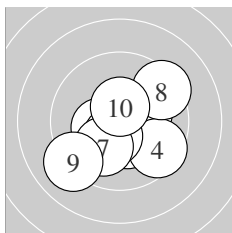
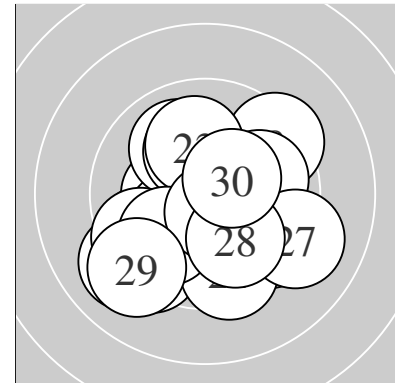

Serie 1:
 10.4 * 10.3 * 10.2 * 9.5 ↘ 10.3 *
 10.5 * 10.0 ↙ 9.4 ↗ 9.1 ↙ 10.5 *
 beste Teiler 110.0 (10.) 123.5 (6.) 148.6 (1.)
 Trefferlage 0.05 mm rechts, 0.69 mm tief
 Streuwert 1.88, horizontal: 2.10, vertikal: 1.65

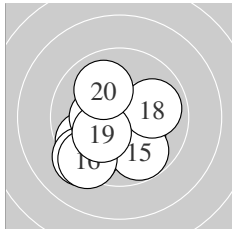

Serie 2:
 9.7 ↙ 9.5 ↙ 10.2 * 9.3 ↙ 9.8 ↘
 9.4 ↙ 10.3 * 9.9 → 10.2 * 10.0 ↘
 beste Teiler 158.0 (17.) 180.0 (19.) 181.7 (13.)
 Trefferlage 0.91 mm links, 1.31 mm tief
 Streuwert 1.84, horizontal: 1.93, vertikal: 1.75

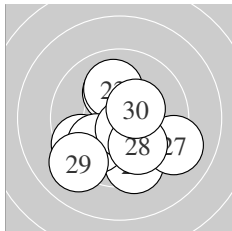

Serie 3:
 10.1 ↑ 9.5 ↙ 10.0 ↑ 9.5 ↓ 9.9 ↙
 10.6 * 9.1 ↘ 10.0 ↓ 9.1 ↙ 10.4 *
 beste Teiler 92.1 (26.) 141.1 (30.) 201.2 (21.)
 Trefferlage 0.06 mm links, 1.07 mm tief
 Streuwert 2.12, horizontal: 2.20, vertikal: 2.04

Unterschrift des Schützen

Ergebnis: **301.4** (286)
 Serien: 100.2 103.6 97.6
 Zähler: 16 14 0 0 0 0 0 0 0 0
 Innenzehner: 14
 weiteste: 471 (24), 450 (29), 405 (15)
 beste Teiler 43.0 (3.) 49.0 (14.) 54.0 (17.)
 Trefferlage 0.76 mm links, 0.41 mm hoch
 Streuwert 1.76, horizontal: 1.85, vertikal: 1.66

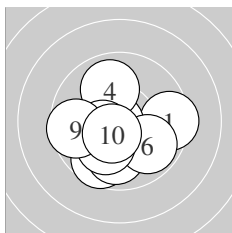
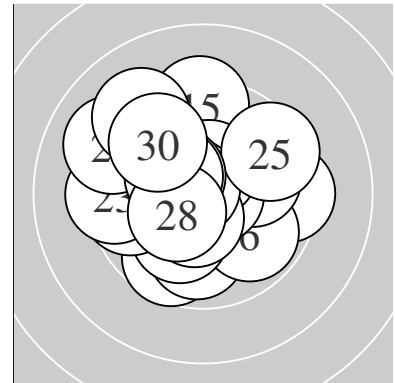

Serie 1:
 9.4 → 9.7 ↙ 10.8 * 9.9 ↑ 9.9 ↓
 9.9 ↘ 10.4 * 10.1 ↙ 9.6 ← 10.5 *
 beste Teiler 43.0 (3.) 110.9 (10.) 143.5 (7.)
 Trefferlage 0.32 mm links, 0.88 mm tief
 Streuwert 1.76, horizontal: 1.97, vertikal: 1.53

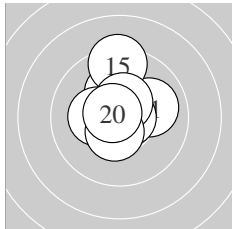

Serie 2:
 10.0 → 10.6 * 10.2 * 10.8 * 9.3 ↑
 10.3 * 10.7 * 10.5 * 10.5 * 10.7 *
 beste Teiler 49.0 (14.) 54.0 (17.) 63.1 (20.)
 Trefferlage 0.13 mm links, 0.76 mm hoch
 Streuwert 1.22, horizontal: 1.04, vertikal: 1.39

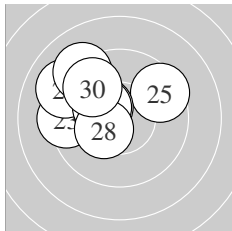

Serie 3:
 9.8 ↘ 9.9 ↘ 9.3 ← 9.1 ↘ 9.5 ↗
 10.4 * 10.3 * 10.4 * 9.2 ↘ 9.7 ↘
 beste Teiler 145.6 (28.) 147.5 (26.) 156.5 (27.)
 Trefferlage 1.84 mm links, 1.38 mm hoch
 Streuwert 1.69, horizontal: 2.03, vertikal: 1.26

Unterschrift des Schützen

Ergebnis: **301.4** (288)
 Serien: 100.3 99.9 101.2
 Zähler: 18 12 0 0 0 0 0 0 0 0
 Innenzehner: 12
 weiteste: 406 (7), 385 (12), 333 (5)
 beste Teiler 94.6 (2.) 110.0 (24.) 121.1 (3.)
 Trefferlage 0.58 mm links, 0.68 mm hoch
 Streuwert 1.60, horizontal: 1.92, vertikal: 1.20

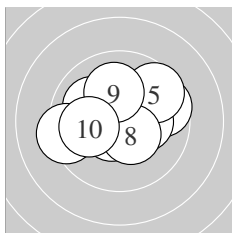
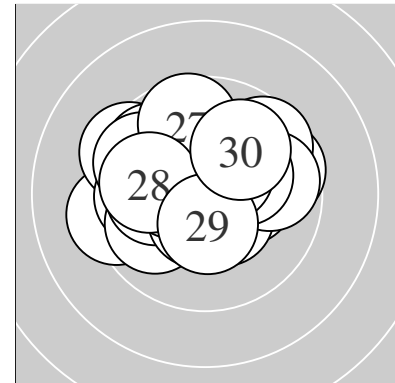

Serie 1:
 9.6 → 10.6 * 10.5 * 10.2 * 9.6 ↗
 10.0 ↖ 9.3 ← 10.4 * 10.1 ↑ 10.0 ←
 beste Teiler 94.6 (2.) 121.1 (3.) 129.0 (8.)
 Trefferlage 0.02 mm rechts, 0.37 mm hoch
 Streuwert 1.82, horizontal: 2.29, vertikal: 1.19

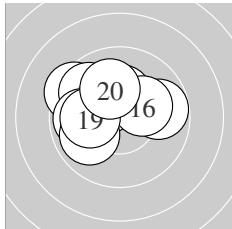

Serie 2:
 10.3 * 9.4 ↖ 9.8 ↖ 9.8 → 10.4 *
 10.2 * 9.9 ← 9.9 ↙ 10.1 ← 10.1 ↑
 beste Teiler 142.1 (15.) 165.7 (11.) 189.1 (16.)
 Trefferlage 0.98 mm links, 0.83 mm hoch
 Streuwert 1.63, horizontal: 2.03, vertikal: 1.09

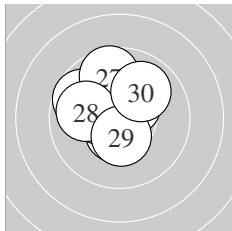

Serie 3:
 10.1 ↖ 10.2 * 9.7 ↖ 10.5 * 10.4 *
 10.4 * 9.7 ↑ 9.9 ← 10.4 * 9.9 ↗
 beste Teiler 110.0 (24.) 128.3 (25.) 134.5 (29.)
 Trefferlage 0.79 mm links, 0.85 mm hoch
 Streuwert 1.38, horizontal: 1.39, vertikal: 1.36

Unterschrift des Schützen

Ergebnis: **305.6** (294)
 Serien: 102.3 101.6 101.7
 Zähler: 24 6 0 0 0 0 0 0 0 0
 Innenzehner: 17
 weiteste: 363 (17), 347 (24), 303 (10)
 beste Teiler 32.2 (3.) 60.8 (30.) 77.8 (25.)
 Trefferlage 0.61 mm links, 0.41 mm tief
 Streuwert 1.40, horizontal: 1.27, vertikal: 1.51

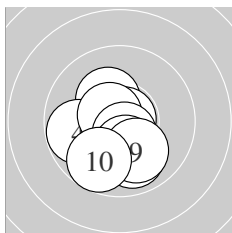
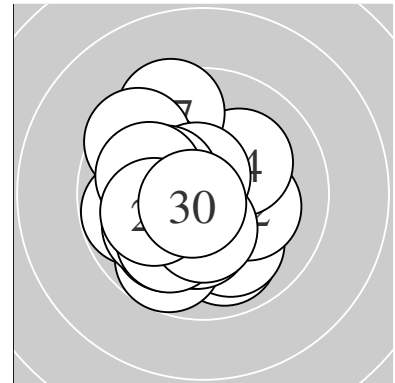

Serie 1:
 10.4 * 10.3 * 10.8 * 9.8 ← 10.6 *
 9.9 ↓ 10.6 * 10.2 * 10.0 ↓ 9.7 ↙
 beste Teiler 32.2 (3.) 81.8 (5.) 97.7 (7.)
 Trefferlage 0.23 mm links, 1.00 mm tief
 Streuwert 1.29, horizontal: 1.21, vertikal: 1.35

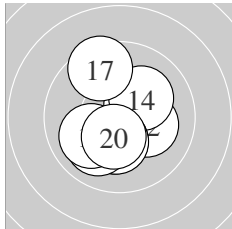

Serie 2:
 10.4 * 10.2 * 10.3 * 10.2 * 10.3 *
 10.3 * 9.5 ↖ 10.0 ↗ 10.0 ↗ 10.4 *
 beste Teiler 141.2 (11.) 142.0 (20.) 168.8 (15.)
 Trefferlage 0.15 mm links, 0.46 mm tief
 Streuwert 1.54, horizontal: 1.30, vertikal: 1.75

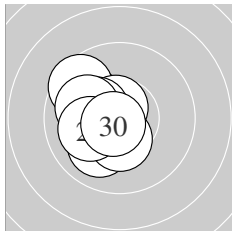

Serie 3:
 10.0 ↗ 10.1 ↖ 9.9 ↖ 9.6 ↖ 10.6 *
 10.4 * 10.3 * 10.0 ↖ 10.1 ← 10.7 *
 beste Teiler 60.8 (30.) 77.8 (25.) 145.0 (26.)
 Trefferlage 1.45 mm links, 0.22 mm hoch
 Streuwert 1.12, horizontal: 0.93, vertikal: 1.29

Unterschrift des Schützen

Ergebnis: **307.3** (294)
 Serien: 101.5 102.6 103.2
 Zähler: 24 6 0 0 0 0 0 0 0 0
 Innenzehner: 19
 weiteste: 434 (9), 431 (21), 420 (16)
 beste Teiler 23.6 (29.) 51.3 (30.) 55.3 (20.)
 Trefferlage 0.07 mm rechts, 0.02 mm tief
 Streuwert 1.50, horizontal: 1.65, vertikal: 1.33

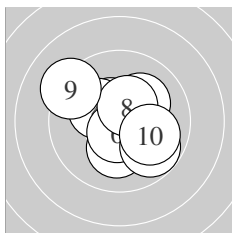
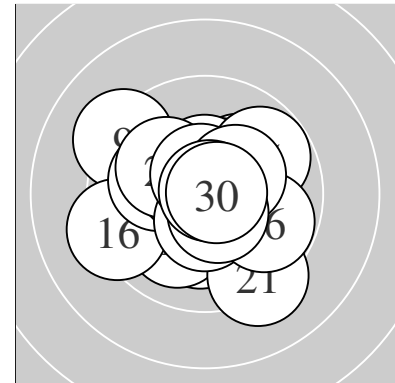

Serie 1:
 10.5 * 10.2 * 10.5 * 10.2 * 10.1 ↗
 10.6 * 9.8 ↘ 10.4 * 9.2 ↖ 10.0 ↘
 beste Teiler 83.9 (6.) 108.8 (1.) 117.8 (3.)
 Trefferlage 0.13 mm rechts, 0.07 mm hoch
 Streuwert 1.66, horizontal: 1.82, vertikal: 1.48

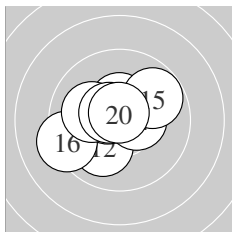

Serie 2:
 10.7 * 10.0 ↙ 10.4 * 10.4 * 9.8 ↗
 9.3 ← 10.6 * 10.1 ← 10.6 * 10.7 *
 beste Teiler 55.3 (20.) 63.0 (11.) 95.4 (19.)
 Trefferlage 0.58 mm links, 0.16 mm hoch
 Streuwert 1.46, horizontal: 1.73, vertikal: 1.12

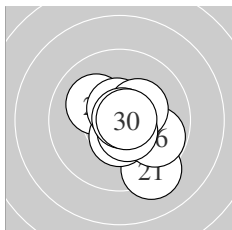

Serie 3:
 9.2 ↘ 10.1 ↖ 10.5 * 10.5 * 10.6 *
 9.8 ↘ 10.3 * 10.6 * 10.9 * 10.7 *
 beste Teiler 23.6 (29.) 51.3 (30.) 89.0 (25.)
 Trefferlage 0.66 mm rechts, 0.31 mm tief
 Streuwert 1.36, horizontal: 1.27, vertikal: 1.45

Unterschrift des Schützen

Ergebnis: **313.5** (299)
 Serien: 105.5 104.6 103.4
 Zähler: 29 1 0 0 0 0 0 0 0 0
 Innenzehner: 26
 weiteste: 266 (26), 237 (15), 234 (5)
 beste Teiler 38.9 (7.) 47.2 (29.) 54.1 (3.)
 Trefferlage 0.03 mm rechts, 0.06 mm hoch
 Streuwert 1.01, horizontal: 1.01, vertikal: 1.00

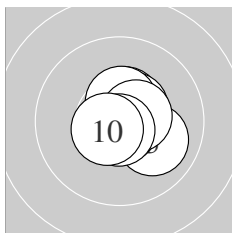
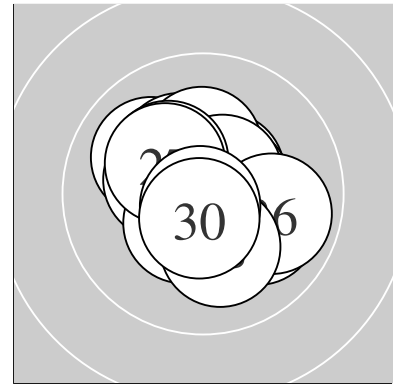

Serie 1:
 10.7 * 10.5 * 10.7 * 10.5 * 10.0 ↘
 10.5 * 10.8 * 10.5 * 10.7 * 10.6 *
 beste Teiler 38.9 (7.) 54.1 (3.) 55.2 (9.)
 Trefferlage 0.47 mm rechts, 0.07 mm hoch
 Streuwert 0.76, horizontal: 0.74, vertikal: 0.78

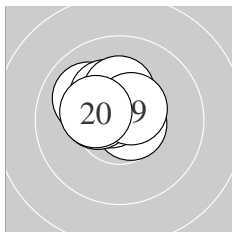

Serie 2:
 10.7 * 10.7 * 10.7 * 10.7 * 10.0 ↘
 10.4 * 10.3 * 10.3 * 10.5 * 10.3 *
 beste Teiler 65.7 (12.) 72.0 (11.) 73.3 (13.)
 Trefferlage 0.51 mm links, 0.79 mm hoch
 Streuwert 0.76, horizontal: 0.90, vertikal: 0.59

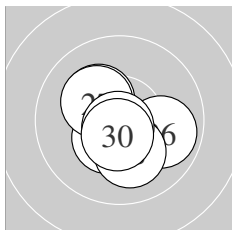

Serie 3:
 10.4 * 10.4 * 10.4 * 10.2 * 10.4 *
 9.9 → 10.2 * 10.1 ↓ 10.8 * 10.6 *
 beste Teiler 47.2 (29.) 92.0 (30.) 131.1 (23.)
 Trefferlage 0.12 mm rechts, 0.66 mm tief
 Streuwert 1.11, horizontal: 1.17, vertikal: 1.06

Unterschrift des Schützen

Ergebnis: **304.2** (292)
 Serien: 102.9 101.7 99.6
 Zähler: 23 6 1 0 0 0 0 0 0 0
 Innenzehner: 16
 weiteste: 592 (26), 373 (17), 350 (11)
 beste Teiler 11.0 (20.) 85.4 (3.) 100.2 (24.)
 Trefferlage 0.54 mm rechts, 0.05 mm hoch
 Streuwert 1.61, horizontal: 1.70, vertikal: 1.51

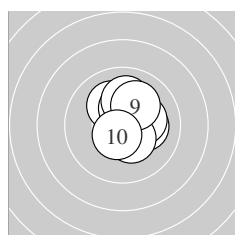
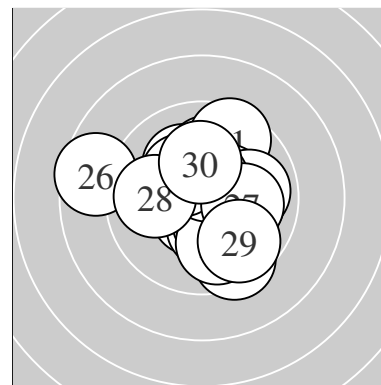

Serie 1:
 10.1 ↘ 10.2 * 10.6 * 10.3 * 10.3 *
 10.1 ↑ 10.2 * 10.4 * 10.1 ↗ 10.6 *
 beste Teiler 85.4 (3.) 100.8 (10.) 142.2 (8.)
 Trefferlage 0.65 mm rechts, 0.67 mm hoch
 Streuwert 1.08, horizontal: 0.99, vertikal: 1.16

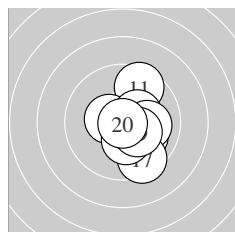

Serie 2:
 9.6 ↗ 10.5 * 10.4 * 10.1 ↘ 10.0 ↘
 10.1 → 9.5 ↘ 10.3 * 10.3 * 10.9 *
 beste Teiler 11.0 (20.) 124.9 (12.) 149.3 (13.)
 Trefferlage 1.08 mm rechts, 0.45 mm tief
 Streuwert 1.41, horizontal: 1.06, vertikal: 1.69

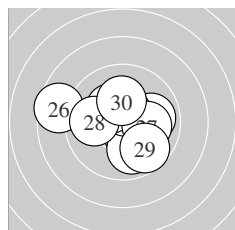

Serie 3:
 10.4 * 9.9 ↘ 9.9 → 10.6 * 10.3 *
 8.6 ← 10.1 → 9.9 ← 9.7 ↘ 10.2 *
 beste Teiler 100.2 (24.) 145.3 (21.) 164.4 (25.)
 Trefferlage 0.10 mm links, 0.05 mm tief
 Streuwert 2.10, horizontal: 2.53, vertikal: 1.54

Unterschrift des Schützen

Meyton Elektronik

Ergebnis: **301.2** (286)
 Serien: 100.5 100.8 99.9
 Zähler: 16 14 0 0 0 0 0 0 0 0
 Innenzehner: 12
 weiteste: 366 (10), 364 (26), 343 (24)
 beste Teiler 22.4 (13.) 132.1 (20.) 142.1 (7.)
 Trefferlage 0.05 mm links, 0.29 mm hoch
 Streuwert 1.74, horizontal: 1.83, vertikal: 1.63

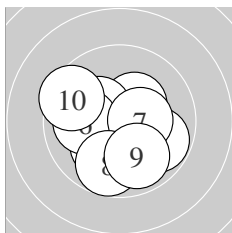
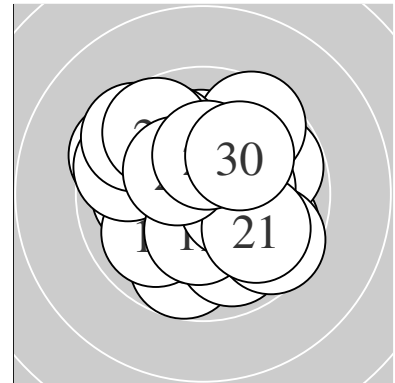

Serie 1:
 9.8 ↘ 10.1 ↙ 10.3 * 10.4 * 10.3 *
 10.0 ← 10.4 * 9.8 ↓ 9.9 ↓ 9.5 ↖
 beste Teiler 142.1 (7.) 143.1 (4.) 151.4 (3.)
 Trefferlage 0.28 mm links, 0.60 mm tief
 Streuwert 1.70, horizontal: 1.85, vertikal: 1.54

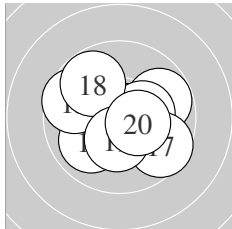

Serie 2:
 10.2 * 9.8 ↗ 10.9 * 9.9 ↙ 9.6 ↖
 10.3 * 9.6 ↘ 9.8 ↘ 10.3 * 10.4 *
 beste Teiler 22.4 (13.) 132.1 (20.) 152.0 (19.)
 Trefferlage 0.33 mm rechts, 0.09 mm tief
 Streuwert 1.75, horizontal: 2.07, vertikal: 1.35

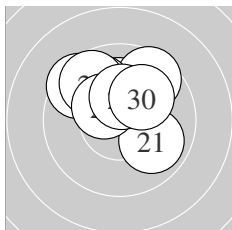

Serie 3:
 9.9 ↘ 10.1 ↑ 10.4 * 9.6 ↗ 9.9 ↘
 9.5 ↖ 9.7 ↖ 10.4 * 10.3 * 10.1 ↗
 beste Teiler 142.3 (28.) 149.5 (23.) 160.7 (29.)
 Trefferlage 0.22 mm links, 1.59 mm hoch
 Streuwert 1.47, horizontal: 1.69, vertikal: 1.21

 Unterschrift des Schützen

Ergebnis: **311.0** (297)
 Serien: 103.8 102.6 104.6
 Zähler: 27 3 0 0 0 0 0 0 0 0
 Innenzehner: 24
 weiteste: 331 (24), 293 (11), 288 (22)
 beste Teiler 17.0 (25.) 41.7 (26.) 54.7 (4.)
 Trefferlage 0.22 mm links, 0.31 mm hoch
 Streuwert 1.16, horizontal: 1.09, vertikal: 1.23

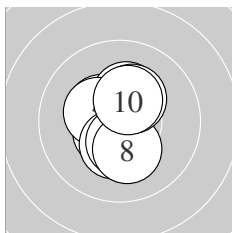
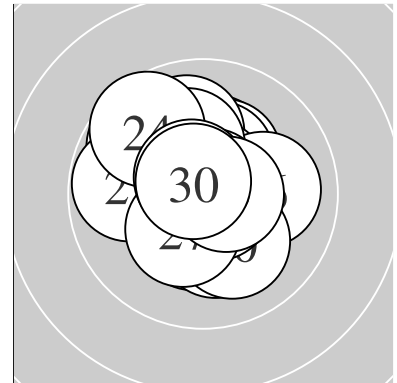

Serie 1:
 10.4 * 10.5 * 10.3 * 10.7 * 10.3 *
 10.3 * 10.4 * 10.2 * 10.3 * 10.4 *
 beste Teiler 54.7 (4.) 105.6 (2.) 134.0 (7.)
 Trefferlage 0.16 mm links, 0.00 mm
 Streuwert 1.08, horizontal: 0.76, vertikal: 1.31

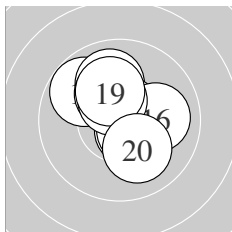

Serie 2:
 9.8 ↘ 10.6 * 10.0 ↑ 10.7 * 10.6 *
 10.0 → 10.2 * 10.4 * 10.2 * 10.1 ↘
 beste Teiler 72.8 (14.) 92.7 (12.) 100.6 (15.)
 Trefferlage 0.04 mm rechts, 0.66 mm hoch
 Streuwert 1.33, horizontal: 1.27, vertikal: 1.38

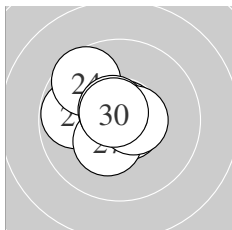

Serie 3:
 10.6 * 9.8 ← 10.7 * 9.6 ↘ 10.9 *
 10.8 * 10.3 * 10.6 * 10.6 * 10.7 *
 beste Teiler 17.0 (25.) 41.7 (26.) 58.6 (23.)
 Trefferlage 0.57 mm links, 0.29 mm hoch
 Streuwert 1.08, horizontal: 1.18, vertikal: 0.97

Unterschrift des Schützen

Ergebnis: **307.6** (293)
 Serien: 103.2 98.7 105.7
 Zähler: 24 5 1 0 0 0 0 0 0 0
 Innenzehner: 20
 weiteste: 548 (18), 431 (12), 416 (16)
 beste Teiler 16.7 (14.) 26.8 (22.) 35.3 (29.)
 Trefferlage 0.66 mm rechts, 0.13 mm tief
 Streuwert 1.47, horizontal: 1.72, vertikal: 1.16

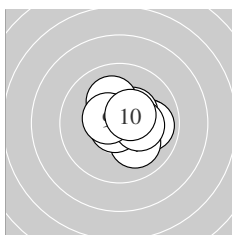
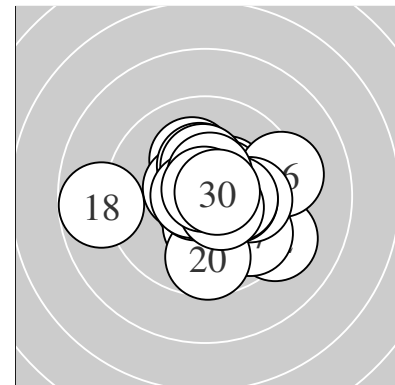

Serie 1:
 10.7 * 10.0 → 9.9 → 10.1 ↘ 10.4 *
 10.1 ↗ 10.7 * 10.3 * 10.5 * 10.5 *
 beste Teiler 51.8 (7.) 72.0 (1.) 111.2 (9.)
 Trefferlage 0.85 mm rechts, 0.17 mm hoch
 Streuwert 1.10, horizontal: 1.24, vertikal: 0.94

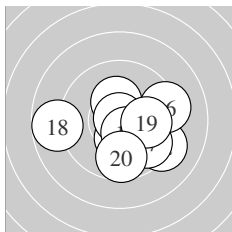

Serie 2:
 10.3 * 9.2 ↘ 10.3 * 10.9 * 10.5 *
 9.3 → 9.7 ↘ 8.8 ← 10.0 → 9.7 ↓
 beste Teiler 16.7 (14.) 123.5 (15.) 156.0 (11.)
 Trefferlage 0.74 mm rechts, 0.78 mm tief
 Streuwert 2.19, horizontal: 2.70, vertikal: 1.52

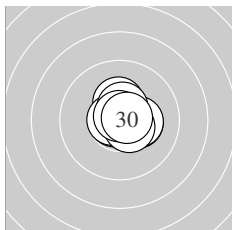

Serie 3:
 10.8 * 10.8 * 10.3 * 10.3 * 10.7 *
 10.3 * 10.5 * 10.5 * 10.8 * 10.7 *
 beste Teiler 26.8 (22.) 35.3 (29.) 46.0 (21.)
 Trefferlage 0.38 mm rechts, 0.19 mm hoch
 Streuwert 0.71, horizontal: 0.77, vertikal: 0.65

Unterschrift des Schützen

Ergebnis: **312.8** (299)
 Serien: 106.3 102.6 103.9
 Zähler: 29 1 0 0 0 0 0 0 0 0
 Innenzehner: 25
 weiteste: 313 (23), 241 (15), 241 (20)
 beste Teiler 3.6 (4.) 23.7 (1.) 28.1 (28.)
 Trefferlage 0.20 mm links, 0.07 mm hoch
 Streuwert 1.06, horizontal: 1.32, vertikal: 0.72

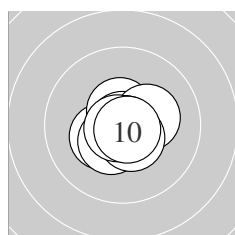
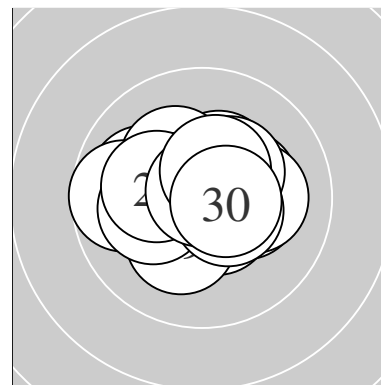

Serie 1:
 10.9 * 10.3 * 10.6 * 10.9 * 10.4 *
 10.3 * 10.8 * 10.5 * 10.8 * 10.8 *
 beste Teiler 3.6 (4.) 23.7 (1.) 30.5 (7.)
 Trefferlage 0.02 mm links, 0.19 mm tief
 Streuwert 0.71, horizontal: 0.80, vertikal: 0.62

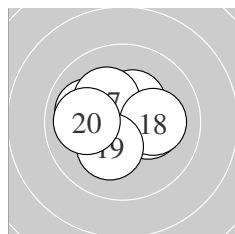

Serie 2:
 10.5 * 10.4 * 10.5 * 10.3 * 10.0 ←
 10.4 * 10.2 * 10.1 → 10.2 * 10.0 ←
 beste Teiler 106.2 (11.) 122.3 (13.) 137.6 (12.)
 Trefferlage 0.19 mm links, 0.20 mm hoch
 Streuwert 1.32, horizontal: 1.62, vertikal: 0.93

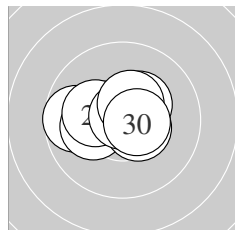

Serie 3:
 10.5 * 10.7 * 9.7 ← 10.1 ← 10.5 *
 10.3 * 10.2 * 10.8 * 10.5 * 10.6 *
 beste Teiler 28.1 (28.) 54.2 (22.) 97.0 (30.)
 Trefferlage 0.38 mm links, 0.22 mm hoch
 Streuwert 1.14, horizontal: 1.51, vertikal: 0.55

Unterschrift des Schützen

Meyton Elektronik

Ergebnis: **301.3** (291)
 Serien: 99.8 101.1 100.4
 Zähler: 21 9 0 0 0 0 0 0 0 0
 Innenzehner: 11
 weiteste: 445 (18), 401 (1), 380 (23)
 beste Teiler 71.4 (4.) 84.3 (15.) 87.2 (27.)
 Trefferlage 0.30 mm links, 0.10 mm tief
 Streuwert 1.75, horizontal: 2.13, vertikal: 1.25

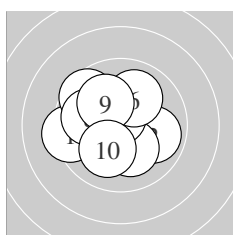
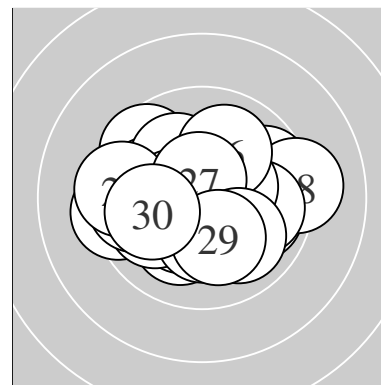

Serie 1:
 9.3 ← 9.9 → 10.2 * 10.7 * 10.0 ↘
 10.0 ↗ 9.6 ↖ 9.9 ← 10.1 ↖ 10.1 ↙
 beste Teiler 71.4 (4.) 196.1 (3.) 212.4 (9.)
 Trefferlage 0.92 mm links, 0.35 mm hoch
 Streuwert 1.77, horizontal: 1.98, vertikal: 1.53

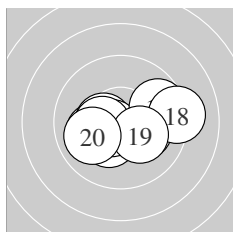

Serie 2:
 10.1 ← 10.3 * 10.4 * 10.2 * 10.6 *
 9.7 → 10.4 * 9.2 → 10.2 * 10.0 ←
 beste Teiler 84.3 (15.) 134.0 (13.) 145.6 (17.)
 Trefferlage 0.20 mm rechts, 0.36 mm tief
 Streuwert 1.71, horizontal: 2.30, vertikal: 0.78

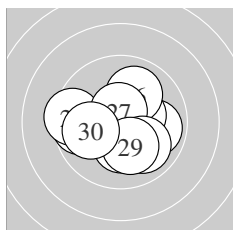

Serie 3:
 9.7 ← 10.3 * 9.4 ← 9.9 → 10.4 *
 10.0 ↗ 10.6 * 10.0 ↘ 10.1 ↓ 10.0 ←
 beste Teiler 87.2 (27.) 144.1 (25.) 175.0 (22.)
 Trefferlage 0.19 mm links, 0.28 mm tief
 Streuwert 1.80, horizontal: 2.18, vertikal: 1.31

Unterschrift des Schützen

Meyton Elektronik

Ergebnis: **304.7** (292)
 Serien: 101.3 101.0 102.4
 Zähler: 22 8 0 0 0 0 0 0 0 0
 Innenzehner: 17
 weiteste: 481 (13), 403 (1), 356 (28)
 beste Teiler 51.4 (20.) 75.9 (27.) 96.5 (26.)
 Trefferlage 0.67 mm rechts, 0.15 mm hoch
 Streuwert 1.51, horizontal: 1.68, vertikal: 1.31

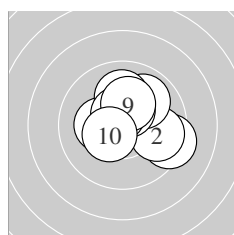
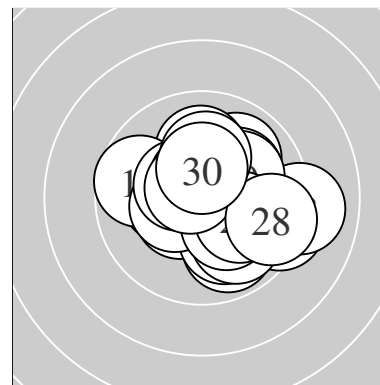

Serie 1:
 9.3 → 9.8 → 10.3 * 9.9 ↗ 10.4 *
 10.0 ↑ 10.4 * 10.6 * 10.2 * 10.4 *
 beste Teiler 98.2 (8.) 129.9 (7.) 130.6 (10.)
 Trefferlage 0.58 mm rechts, 0.67 mm hoch
 Streuwert 1.51, horizontal: 1.71, vertikal: 1.27

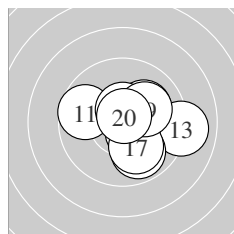

Serie 2:
 9.7 ← 10.5 * 9.0 → 10.1 ↗ 10.5 *
 9.9 ↘ 10.0 ↘ 10.5 * 10.1 ↗ 10.7 *
 beste Teiler 51.4 (20.) 102.0 (18.) 116.6 (15.)
 Trefferlage 0.94 mm rechts, 0.19 mm tief
 Streuwert 1.66, horizontal: 1.94, vertikal: 1.31

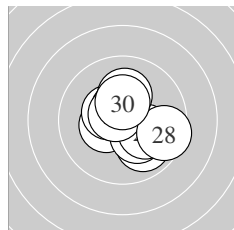

Serie 3:
 10.4 * 10.4 * 9.9 ↘ 10.2 * 10.1 ↘
 10.6 * 10.7 * 9.5 → 10.2 * 10.4 *
 beste Teiler 75.9 (27.) 96.5 (26.) 128.5 (22.)
 Trefferlage 0.49 mm rechts, 0.02 mm tief
 Streuwert 1.41, horizontal: 1.50, vertikal: 1.30

Unterschrift des Schützen

Meyton Elektronik

Ergebnis: **305.9** (294)
 Serien: 101.5 102.0 102.4
 Zähler: 24 6 0 0 0 0 0 0 0 0
 Innenzehner: 18
 weiteste: 405 (8), 358 (6), 326 (21)
 beste Teiler 42.4 (7.) 64.6 (1.) 70.0 (28.)
 Trefferlage 0.52 mm rechts, 0.57 mm hoch
 Streuwert 1.40, horizontal: 1.56, vertikal: 1.23

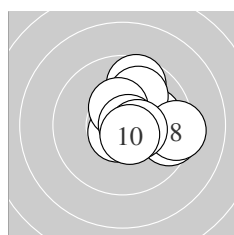
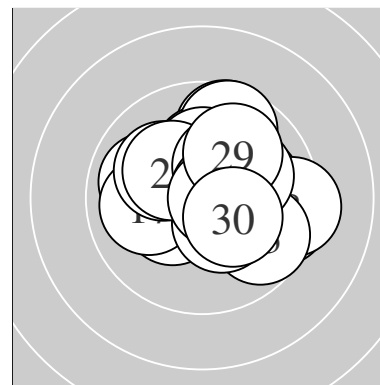

Serie 1:
 10.7 * 10.0 → 9.7 ↑ 10.0 ↗ 10.4 *
 9.5 → 10.8 * 9.3 → 10.5 * 10.6 *
 beste Teiler 42.4 (7.) 64.6 (1.) 88.4 (10.)
 Trefferlage 1.33 mm rechts, 0.44 mm hoch
 Streuwert 1.41, horizontal: 1.49, vertikal: 1.33

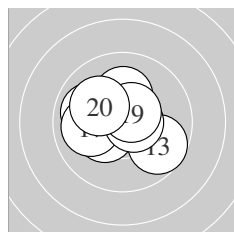

Serie 2:
 10.4 * 10.3 * 9.7 ↘ 10.2 * 10.2 *
 9.9 ← 10.0 ← 10.6 * 10.6 * 10.1 ↖
 beste Teiler 84.0 (18.) 98.4 (19.) 128.7 (11.)
 Trefferlage 0.53 mm links, 0.39 mm hoch
 Streuwert 1.40, horizontal: 1.66, vertikal: 1.09

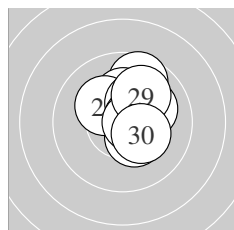

Serie 3:
 9.6 ↑ 10.1 ↗ 10.2 * 10.4 * 10.2 *
 10.3 * 10.6 * 10.7 * 10.0 ↗ 10.3 *
 beste Teiler 70.0 (28.) 89.1 (27.) 143.8 (24.)
 Trefferlage 0.78 mm rechts, 0.89 mm hoch
 Streuwert 1.13, horizontal: 0.90, vertikal: 1.32

Unterschrift des Schützen

Meyton Elektronik

Ergebnis: **310.8** (296)
 Serien: 103.3 104.1 103.4
 Zähler: 26 4 0 0 0 0 0 0 0 0
 Innenzehner: 23
 weiteste: 367 (24), 322 (5), 312 (9)
 beste Teiler 21.1 (19.) 23.5 (6.) 42.9 (21.)
 Trefferlage 0.40 mm links, 0.52 mm hoch
 Streuwert 1.17, horizontal: 1.28, vertikal: 1.03

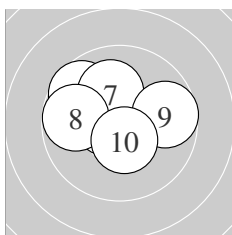
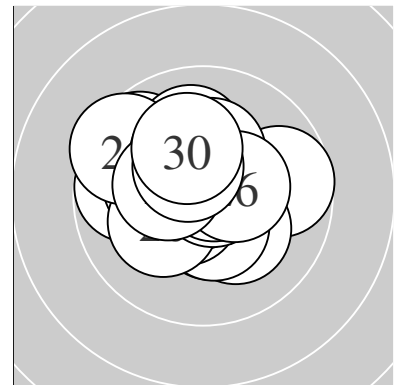

Serie 1:
 10.7 * 10.6 * 10.5 * 10.8 * 9.7 ↖
 10.9 * 10.1 ↑ 9.8 ← 9.7 → 10.5 *
 beste Teiler 23.5 (6.) 44.3 (4.) 67.5 (1.)
 Trefferlage 0.34 mm links, 0.40 mm hoch
 Streuwert 1.39, horizontal: 1.67, vertikal: 1.02

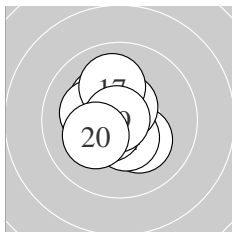

Serie 2:
 10.2 * 10.3 * 10.6 * 10.5 * 10.2 *
 10.6 * 10.0 ↑ 10.6 * 10.9 * 10.2 *
 beste Teiler 21.1 (19.) 88.0 (13.) 92.0 (18.)
 Trefferlage 0.48 mm links, 0.08 mm hoch
 Streuwert 1.07, horizontal: 0.97, vertikal: 1.16

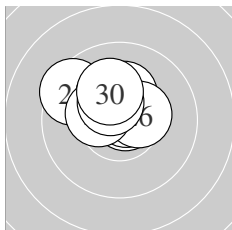

Serie 3:
 10.8 * 10.7 * 10.6 * 9.5 ↖ 10.3 *
 10.4 * 10.2 * 10.4 * 10.4 * 10.1 ↑
 beste Teiler 42.9 (21.) 60.1 (22.) 99.5 (23.)
 Trefferlage 0.37 mm links, 1.07 mm hoch
 Streuwert 1.01, horizontal: 1.25, vertikal: 0.69

Unterschrift des Schützen

Ergebnis: **310.8** (298)
 Serien: 102.7 103.9 104.2
 Zähler: 28 2 0 0 0 0 0 0 0 0
 Innenzehner: 24
 weiteste: 410 (9), 272 (13), 235 (2)
 beste Teiler 21.1 (5.) 56.0 (7.) 60.3 (16.)
 Trefferlage 0.17 mm rechts, 0.44 mm tief
 Streuwert 1.16, horizontal: 1.40, vertikal: 0.86

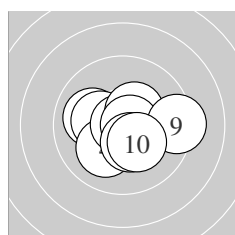
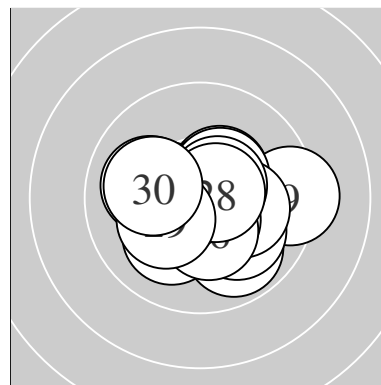

Serie 1:
 10.3 * 10.0 ← 10.3 * 10.1 ✓ 10.9 *
 10.4 * 10.7 * 10.4 * 9.3 → 10.3 *
 beste Teiler 21.1 (5.) 56.0 (7.) 136.1 (6.)
 Trefferlage 0.06 mm rechts, 0.33 mm tief
 Streuwert 1.46, horizontal: 1.84, vertikal: 0.95

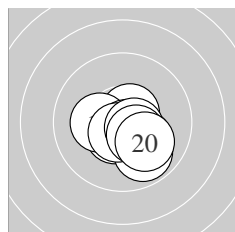

Serie 2:
 10.2 * 10.5 * 9.9 ✘ 10.6 * 10.3 *
 10.7 * 10.6 * 10.6 * 10.4 * 10.1 ✘
 beste Teiler 60.3 (16.) 85.9 (14.) 86.3 (17.)
 Trefferlage 0.47 mm rechts, 0.80 mm tief
 Streuwert 0.96, horizontal: 1.10, vertikal: 0.80

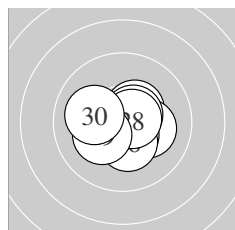

Serie 3:
 10.4 * 10.2 * 10.6 * 10.6 * 10.5 *
 10.3 * 10.6 * 10.7 * 10.2 * 10.1 ←
 beste Teiler 74.9 (28.) 87.5 (27.) 90.1 (24.)
 Trefferlage 0.02 mm links, 0.21 mm tief
 Streuwert 1.05, horizontal: 1.26, vertikal: 0.79

Unterschrift des Schützen

Ergebnis: **297.3** (286)
 Serien: 97.3 100.0 100.0
 Zähler: 16 14 0 0 0 0 0 0 0 0
 Innenzehner: 11
 weiteste: 486 (30), 458 (6), 429 (20)
 beste Teiler 39.0 (27.) 84.4 (11.) 107.8 (18.)
 Trefferlage 0.93 mm links, 0.58 mm tief
 Streuwert 1.88, horizontal: 1.96, vertikal: 1.80

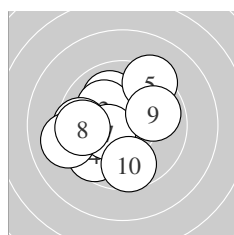
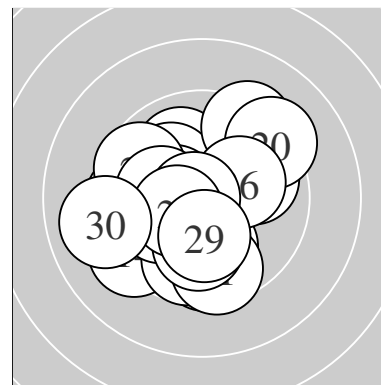

Serie 1:
 10.0 ↖ 10.1 ↘ 9.6 ← 9.6 ↙ 9.3 ↗
 9.1 ← 10.4 * 9.6 ← 9.9 → 9.7 ↓
 beste Teiler 129.7 (7.) 207.9 (2.) 241.5 (1.)
 Trefferlage 1.19 mm links, 0.04 mm hoch
 Streuwert 2.19, horizontal: 2.33, vertikal: 2.03

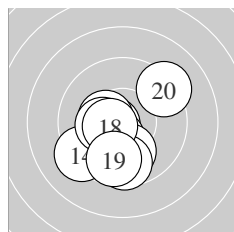

Serie 2:
 10.6 * 10.4 * 10.4 * 9.3 ↙ 10.0 ↓
 9.6 ↓ 10.3 * 10.5 * 9.7 ↓ 9.2 ↗
 beste Teiler 84.4 (11.) 107.8 (18.) 136.9 (12.)
 Trefferlage 0.53 mm links, 1.02 mm tief
 Streuwert 1.78, horizontal: 1.72, vertikal: 1.84

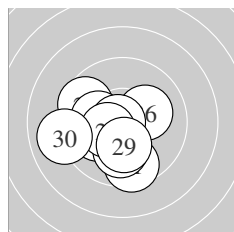

Serie 3:
 9.5 ↓ 10.1 ← 10.0 ↓ 9.6 ↘ 10.2 *
 10.2 * 10.8 * 10.4 * 10.2 * 9.0 ←
 beste Teiler 39.0 (27.) 138.7 (28.) 186.3 (29.)
 Trefferlage 1.08 mm links, 0.78 mm tief
 Streuwert 1.71, horizontal: 1.92, vertikal: 1.48

Unterschrift des Schützen

Meyton Elektronik

Ergebnis: **305.0** (293)
 Serien: 102.3 102.8 99.9
 Zähler: 23 7 0 0 0 0 0 0 0 0
 Innenzehner: 17
 weiteste: 393 (28), 361 (26), 359 (22)
 beste Teiler 55.0 (17.) 64.4 (24.) 69.6 (12.)
 Trefferlage 0.10 mm rechts, 0.23 mm tief
 Streuwert 1.53, horizontal: 1.50, vertikal: 1.56

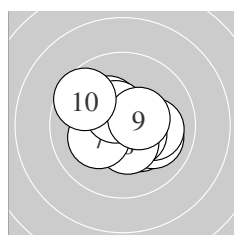
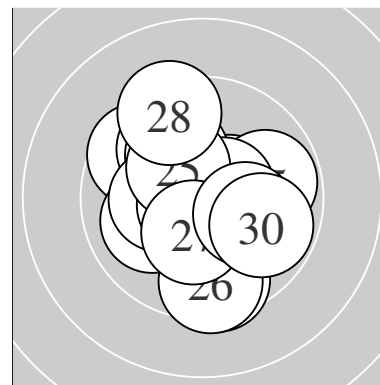

Serie 1:
 10.3 * 10.3 * 10.0 → 10.1 → 10.5 *
 10.4 * 10.2 * 10.5 * 10.4 * 9.6 ↖
 beste Teiler 108.2 (8.) 114.8 (5.) 126.4 (9.)
 Trefferlage 0.20 mm rechts, 0.04 mm tief
 Streuwert 1.41, horizontal: 1.65, vertikal: 1.12

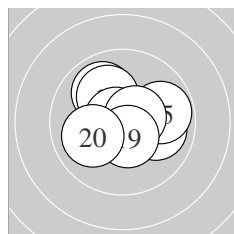

Serie 2:
 9.9 ↖ 10.7 * 10.0 → 10.1 ↖ 9.8 →
 10.5 * 10.7 * 10.6 * 10.5 * 10.0 ←
 beste Teiler 55.0 (17.) 69.6 (12.) 97.3 (18.)
 Trefferlage 0.00 mm , 0.15 mm hoch
 Streuwert 1.38, horizontal: 1.60, vertikal: 1.12

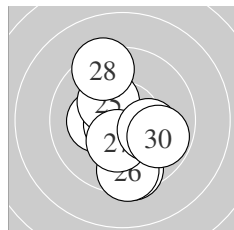

Serie 3:
 10.2 * 9.5 ↓ 10.0 ↓ 10.7 * 10.3 *
 9.5 ↓ 10.3 * 9.4 ↖ 10.2 * 9.8 →
 beste Teiler 64.4 (24.) 153.7 (27.) 166.6 (25.)
 Trefferlage 0.09 mm rechts, 0.81 mm tief
 Streuwert 1.84, horizontal: 1.40, vertikal: 2.19

Unterschrift des Schützen

Meyton Elektronik

Ergebnis: **302.2** (289)
 Serien: 99.8 99.9 102.5
 Zähler: 20 9 1 0 0 0 0 0 0 0
 Innenzehner: 14
 weiteste: 602 (12), 362 (5), 346 (1)
 beste Teiler 68.8 (23.) 104.2 (11.) 108.4 (28.)
 Trefferlage 0.49 mm links, 0.59 mm hoch
 Streuwert 1.67, horizontal: 1.84, vertikal: 1.47

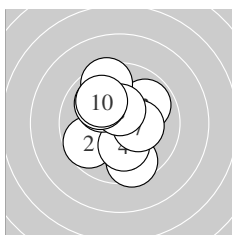
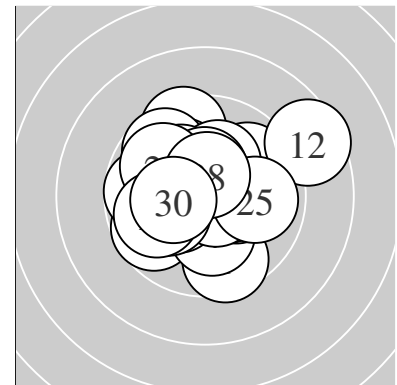

Serie 1:
 9.6 ↘ 9.7 ↙ 9.9 ↗ 10.2 * 9.5 ↗
 10.1 ↖ 10.3 * 10.5 * 10.0 ↖ 10.0 ↖
 beste Teiler 116.0 (8.) 163.6 (7.) 194.5 (4.)
 Trefferlage 0.32 mm links, 0.41 mm hoch
 Streuwert 1.88, horizontal: 1.62, vertikal: 2.11

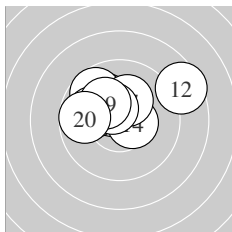

Serie 2:
 10.5 * 8.5 ↗ 10.1 ↖ 10.5 * 9.7 ↖
 10.0 ↖ 10.2 * 10.5 * 10.2 * 9.7 ←
 beste Teiler 104.2 (11.) 114.1 (14.) 118.8 (18.)
 Trefferlage 0.40 mm links, 1.26 mm hoch
 Streuwert 1.81, horizontal: 2.39, vertikal: 0.93

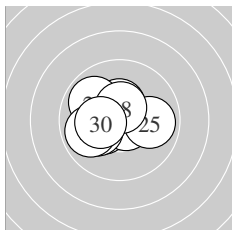

Serie 3:
 10.3 * 10.5 * 10.7 * 10.4 * 9.9 →
 9.9 ↖ 10.1 ← 10.5 * 9.9 ← 10.3 *
 beste Teiler 68.8 (23.) 108.4 (28.) 121.2 (22.)
 Trefferlage 0.76 mm links, 0.10 mm hoch
 Streuwert 1.29, horizontal: 1.57, vertikal: 0.94

Unterschrift des Schützen

Meyton Elektronik

Ergebnis: **303.0** (291)
 Serien: 101.5 102.0 99.5
 Zähler: 21 9 0 0 0 0 0 0 0 0
 Innenzehner: 17
 weiteste: 495 (17), 488 (28), 474 (26)
 beste Teiler 6.0 (8.) 15.8 (30.) 52.4 (11.)
 Trefferlage 0.39 mm links, 0.48 mm tief
 Streuwert 1.74, horizontal: 2.01, vertikal: 1.42

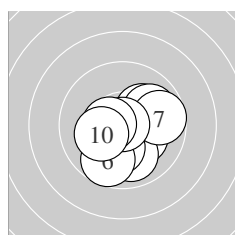
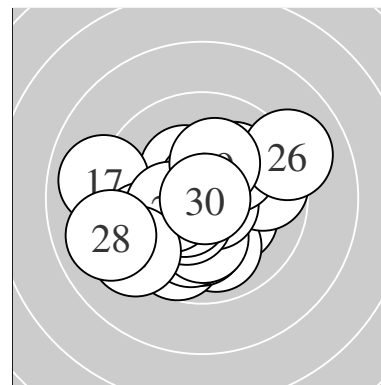

Serie 1:
 10.2 * 10.2 * 10.0 ↓ 9.9 ↗ 10.2 *
 9.7 ↓ 9.7 → 10.9 * 10.5 * 10.2 *
 beste Teiler 6.0 (8.) 110.2 (9.) 180.0 (1.)
 Trefferlage 0.45 mm rechts, 0.56 mm tief
 Streuwert 1.52, horizontal: 1.61, vertikal: 1.44

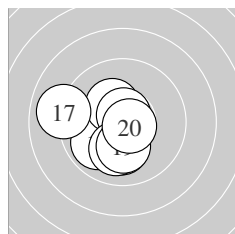

Serie 2:
 10.7 * 10.1 ↓ 10.3 * 9.9 ↙ 10.3 *
 10.7 * 9.0 ← 10.1 ↓ 10.2 * 10.7 *
 beste Teiler 52.4 (11.) 59.5 (16.) 64.4 (20.)
 Trefferlage 0.90 mm links, 0.61 mm tief
 Streuwert 1.48, horizontal: 1.63, vertikal: 1.31

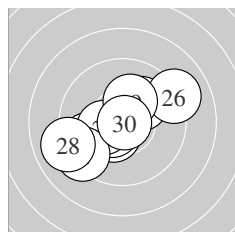

Serie 3:
 9.7 ↙ 10.4 * 10.5 * 10.1 ↗ 10.3 *
 9.1 ↗ 9.3 ↙ 9.0 ← 10.2 * 10.9 *
 beste Teiler 15.8 (30.) 108.8 (23.) 130.6 (22.)
 Trefferlage 0.72 mm links, 0.28 mm tief
 Streuwert 2.14, horizontal: 2.55, vertikal: 1.61

Unterschrift des Schützen

Meyton Elektronik

Ergebnis: **304.8** (291)
 Serien: 100.3 102.5 102.0
 Zähler: 21 9 0 0 0 0 0 0 0 0
 Innenzehner: 18
 weiteste: 386 (3), 370 (7), 358 (21)
 beste Teiler 52.8 (25.) 75.0 (24.) 76.0 (4.)
 Trefferlage 1.16 mm links, 0.06 mm tief
 Streuwert 1.33, horizontal: 1.43, vertikal: 1.22

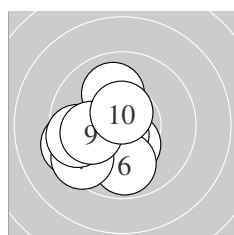
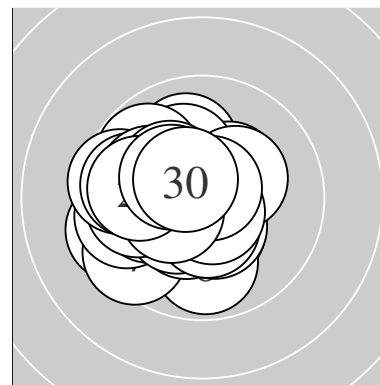

Serie 1:
 10.4 * 10.0 ↗ 9.4 ← 10.6 * 10.3 *
 9.9 ↓ 9.5 ↙ 9.6 ← 10.0 ← 10.6 *
 beste Teiler 76.0 (4.) 90.3 (10.) 146.1 (1.)
 Trefferlage 1.39 mm links, 0.72 mm tief
 Streuwert 1.48, horizontal: 1.51, vertikal: 1.45

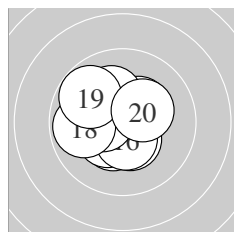

Serie 2:
 10.4 * 10.4 * 10.3 * 10.2 * 10.4 *
 10.5 * 10.4 * 9.8 ← 9.8 ↘ 10.3 *
 beste Teiler 120.4 (16.) 133.4 (11.) 140.0 (12.)
 Trefferlage 0.56 mm links, 0.06 mm hoch
 Streuwert 1.32, horizontal: 1.40, vertikal: 1.23

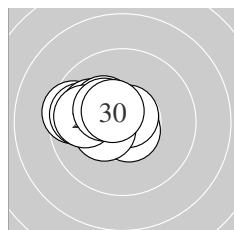

Serie 3:
 9.5 ← 9.7 ← 10.0 ↘ 10.7 * 10.7 *
 10.4 * 10.3 * 9.9 ← 10.3 * 10.5 *
 beste Teiler 52.8 (25.) 75.0 (24.) 106.2 (30.)
 Trefferlage 1.53 mm links, 0.45 mm hoch
 Streuwert 1.03, horizontal: 1.33, vertikal: 0.58

Unterschrift des Schützen

Meyton Elektronik