

Ergebnis: **316.9** (300)
 Serien: 106.8 105.2 104.9
 Zähler: 30 0 0 0 0 0 0 0 0 0
 Innenzehner: 29
 weiteste: 217 (12), 190 (11), 180 (27)
 beste Teiler 6.3 (9.) 13.6 (30.) 26.9 (3.)
 Trefferlage 0.04 mm rechts, 0.09 mm tief
 Streuwert 0.79, horizontal: 0.76, vertikal: 0.82

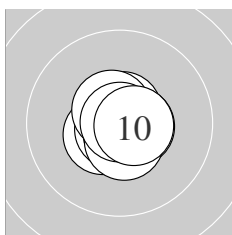

Serie 1:
 10.7 * 10.6 * 10.8 * 10.5 * 10.8 *
 10.7 * 10.6 * 10.6 * 10.9 * 10.6 *
 beste Teiler 6.3 (9.) 26.9 (3.) 44.6 (5.)
 Trefferlage 0.03 mm rechts, 0.15 mm tief
 Streuwert 0.54, horizontal: 0.55, vertikal: 0.54

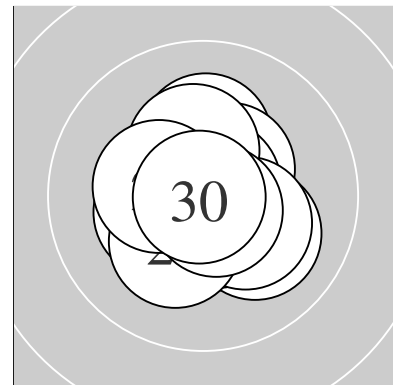
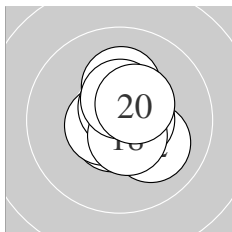

Serie 2:
 10.2 * 10.1 * 10.6 * 10.6 * 10.8 *
 10.6 * 10.7 * 10.6 * 10.5 * 10.5 *
 beste Teiler 43.5 (15.) 72.6 (17.) 77.5 (13.)
 Trefferlage 0.26 mm rechts, 0.12 mm hoch
 Streuwert 0.89, horizontal: 0.74, vertikal: 1.02

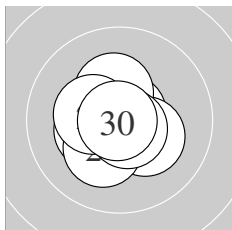

Serie 3:
 10.6 * 10.6 * 10.3 * 10.7 * 10.3 *
 10.3 * 10.2 * 10.7 * 10.3 * 10.9 *
 beste Teiler 13.6 (30.) 53.0 (24.) 66.5 (28.)
 Trefferlage 0.16 mm links, 0.26 mm tief
 Streuwert 0.91, horizontal: 0.95, vertikal: 0.86

Unterschrift des Schützen

Ergebnis: **296.7** (284)
 Serien: 101.5 99.6 95.6
 Zähler: 16 12 2 0 0 0 0 0 0 0
 Innenzehner: 14
 weiteste: 588 (23), 514 (29), 456 (27)
 beste Teiler 35.4 (3.) 81.0 (10.) 81.2 (15.)
 Trefferlage 0.48 mm links, 0.06 mm hoch
 Streuwert 2.12, horizontal: 2.24, vertikal: 1.99

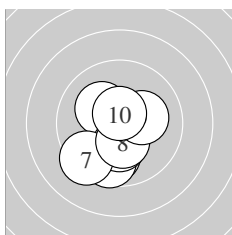
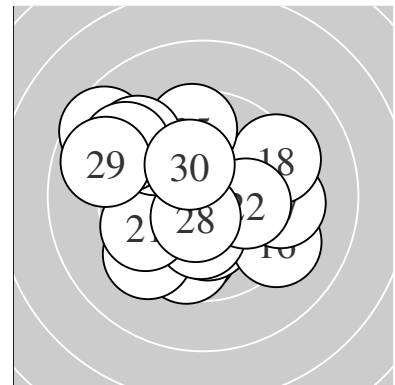

Serie 1:
 9.9 ↓ 10.2 * 10.8 * 9.7 ↓ 10.2 *
 10.2 * 9.4 ↙ 10.3 * 10.2 * 10.6 *
 beste Teiler 35.4 (3.) 81.0 (10.) 152.2 (8.)
 Trefferlage 0.43 mm links, 1.09 mm tief
 Streuwert 1.44, horizontal: 1.19, vertikal: 1.65

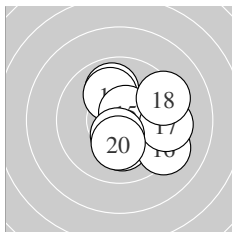

Serie 2:
 9.9 ↑ 10.2 * 10.3 * 10.0 ↑ 10.6 *
 9.2 ↘ 9.4 → 9.3 ↗ 10.5 * 10.2 *
 beste Teiler 81.2 (15.) 124.4 (19.) 159.7 (13.)
 Trefferlage 1.14 mm rechts, 0.15 mm tief
 Streuwert 1.84, horizontal: 1.87, vertikal: 1.81

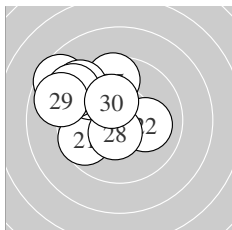

Serie 3:
 9.7 ↙ 10.1 → 8.6 ↖ 9.6 ↖ 9.6 ↑
 9.2 ↖ 9.1 ↖ 10.5 * 8.9 ↖ 10.3 *
 beste Teiler 111.3 (28.) 169.7 (30.) 217.3 (22.)
 Trefferlage 2.16 mm links, 1.43 mm hoch
 Streuwert 2.04, horizontal: 2.26, vertikal: 1.78

Unterschrift des Schützen

Ergebnis: **305.9** (295)
 Serien: 101.9 101.3 102.7
 Zähler: 25 5 0 0 0 0 0 0 0 0
 Innenzehner: 15
 weiteste: 331 (12), 330 (1), 314 (15)
 beste Teiler 67.4 (21.) 81.8 (28.) 91.7 (18.)
 Trefferlage 0.06 mm rechts, 0.18 mm hoch
 Streuwert 1.46, horizontal: 1.29, vertikal: 1.60

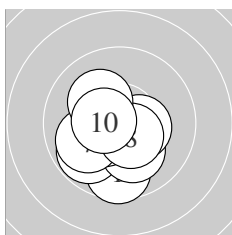
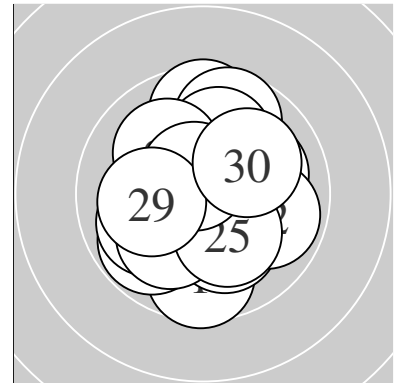

Serie 1:
 9.6 ↓ 10.4 * 9.8 ↙ 10.1 ↘ 10.4 *
 10.4 * 10.0 ↙ 10.5 * 10.2 * 10.5 *
 beste Teiler 109.3 (10.) 116.8 (8.) 129.8 (6.)
 Trefferlage 0.43 mm links, 0.98 mm tief
 Streuwert 1.29, horizontal: 1.28, vertikal: 1.29

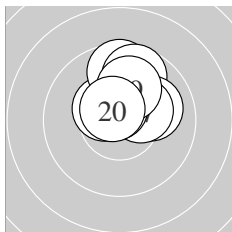

Serie 2:
 10.4 * 9.6 ↑ 10.1 ↗ 10.0 ↗ 9.7 ↗
 10.0 → 10.3 * 10.6 * 10.0 ↗ 10.6 *
 beste Teiler 91.7 (18.) 91.8 (20.) 129.6 (11.)
 Trefferlage 0.52 mm rechts, 1.66 mm hoch
 Streuwert 0.98, horizontal: 0.96, vertikal: 1.00

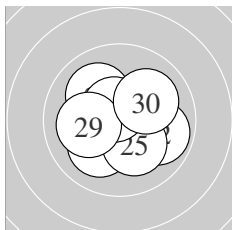

Serie 3:
 10.7 * 9.9 → 10.3 * 10.1 ↙ 10.2 *
 10.6 * 10.1 ↘ 10.6 * 10.1 ← 10.1 ↗
 beste Teiler 67.4 (21.) 81.8 (28.) 96.2 (26.)
 Trefferlage 0.11 mm rechts, 0.11 mm tief
 Streuwert 1.39, horizontal: 1.52, vertikal: 1.25

Unterschrift des Schützen

Ergebnis: **311.6** (298)
 Serien: 104.3 103.1 104.2
 Zähler: 28 2 0 0 0 0 0 0 0 0
 Innenzehner: 24
 weiteste: 366 (10), 253 (16), 226 (19)
 beste Teiler 22.1 (22.) 23.7 (24.) 37.6 (9.)
 Trefferlage 0.06 mm links, 0.41 mm hoch
 Streuwert 1.13, horizontal: 1.18, vertikal: 1.07

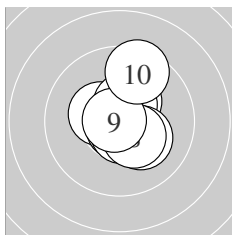
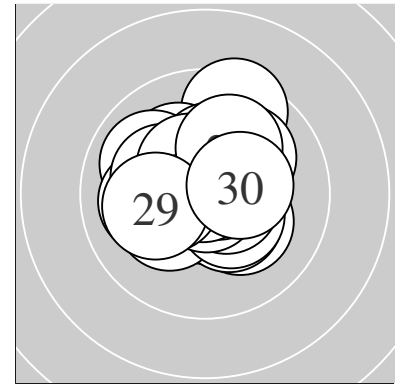

Serie 1:
 10.4 * 10.3 * 10.8 * 10.7 * 10.5 *
 10.7 * 10.2 * 10.4 * 10.8 * 9.5 ↗
 beste Teiler 37.6 (9.) 46.3 (3.) 67.9 (4.)
 Trefferlage 0.37 mm rechts, 0.29 mm hoch
 Streuwert 1.16, horizontal: 0.84, vertikal: 1.41

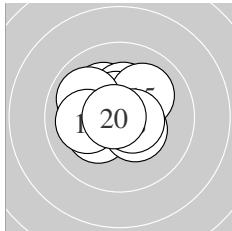

Serie 2:
 10.2 * 10.3 * 10.2 * 10.6 * 10.1 ↗
 9.9 ↘ 10.4 * 10.6 * 10.0 ← 10.8 *
 beste Teiler 39.1 (20.) 93.9 (18.) 98.9 (14.)
 Trefferlage 0.38 mm links, 0.45 mm hoch
 Streuwert 1.21, horizontal: 1.36, vertikal: 1.04

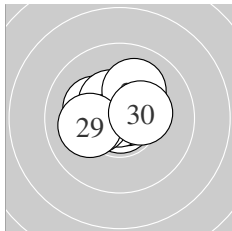

Serie 3:
 10.3 * 10.9 * 10.7 * 10.9 * 10.3 *
 10.2 * 10.4 * 10.1 ↗ 10.1 ← 10.3 *
 beste Teiler 22.1 (22.) 23.7 (24.) 64.4 (23.)
 Trefferlage 0.19 mm links, 0.51 mm hoch
 Streuwert 1.05, horizontal: 1.26, vertikal: 0.77

Unterschrift des Schützen

Ergebnis: **308.5** (295)
 Serien: 103.2 101.9 103.4
 Zähler: 25 5 0 0 0 0 0 0 0 0
 Innenzehner: 20
 weiteste: 311 (10), 293 (1), 277 (21)
 beste Teiler 61.1 (26.) 64.7 (5.) 66.6 (2.)
 Trefferlage 0.18 mm rechts, 0.25 mm tief
 Streuwert 1.28, horizontal: 1.29, vertikal: 1.27

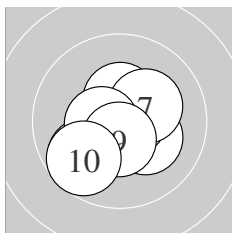
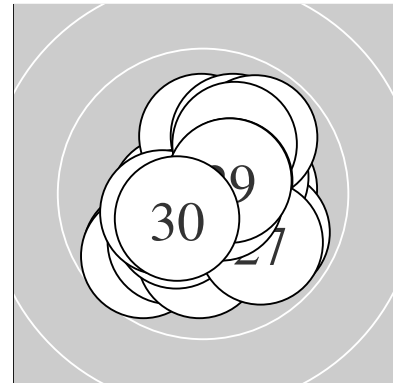

Serie 1:
 9.8 ↗ 10.7 * 10.2 * 10.5 * 10.7 *
 10.4 * 10.2 * 10.5 * 10.5 * 9.7 ↘
 beste Teiler 64.7 (5.) 66.6 (2.) 106.3 (4.)
 Trefferlage 0.33 mm links, 0.44 mm tief
 Streuwert 1.24, horizontal: 1.33, vertikal: 1.15

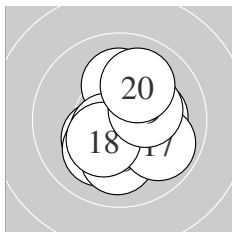

Serie 2:
 10.1 ↑ 10.2 * 10.3 * 10.6 * 10.1 ↘
 10.1 ↓ 9.9 ↘ 10.3 * 10.3 * 10.0 ↗
 beste Teiler 95.7 (14.) 151.9 (18.) 167.5 (19.)
 Trefferlage 0.24 mm rechts, 0.32 mm tief
 Streuwert 1.44, horizontal: 1.35, vertikal: 1.53

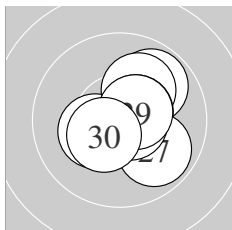

Serie 3:
 9.8 ↗ 10.3 * 10.5 * 10.1 ↗ 10.5 *
 10.7 * 9.9 ↘ 10.7 * 10.5 * 10.4 *
 beste Teiler 61.1 (26.) 66.9 (28.) 106.4 (29.)
 Trefferlage 0.62 mm rechts, 0.02 mm hoch
 Streuwert 1.17, horizontal: 1.14, vertikal: 1.19

 Unterschrift des Schützen

Ergebnis: **298.9** (285)
 Serien: 101.4 99.8 97.7
 Zähler: 17 11 2 0 0 0 0 0 0 0
 Innenzehner: 11
 weiteste: 609 (24), 604 (23), 451 (18)
 beste Teiler 29.4 (1.) 45.7 (12.) 82.4 (5.)
 Trefferlage 0.27 mm rechts, 0.44 mm hoch
 Streuwert 1.98, horizontal: 2.20, vertikal: 1.74

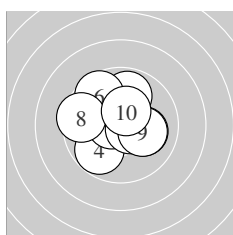
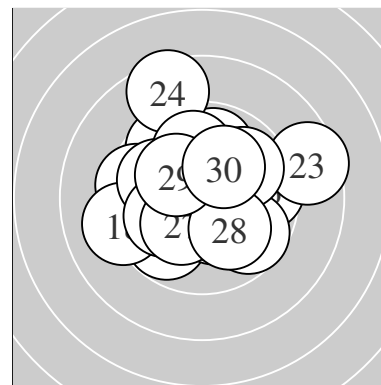

Serie 1:
 10.8 * 10.1 → 9.9 ↑ 9.8 ↙ 10.6 *
 9.6 ↘ 10.6 * 9.5 ← 10.1 → 10.4 *
 beste Teiler 29.4 (1.) 82.4 (5.) 92.8 (7.)
 Trefferlage 0.19 mm links, 0.37 mm hoch
 Streuwert 1.68, horizontal: 1.83, vertikal: 1.51

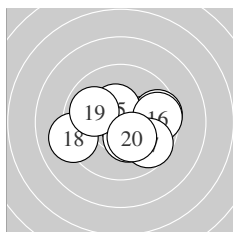

Serie 2:
 10.1 → 10.8 * 10.3 * 9.6 → 10.4 *
 9.6 → 9.7 ↘ 9.1 ← 9.9 ↖ 10.3 *
 beste Teiler 45.7 (12.) 130.3 (15.) 152.5 (13.)
 Trefferlage 0.63 mm rechts, 0.28 mm tief
 Streuwert 1.93, horizontal: 2.48, vertikal: 1.14

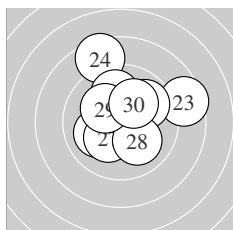

Serie 3:
 10.2 * 10.1 ← 8.5 → 8.5 ↑ 9.9 ↑
 9.9 ↗ 10.2 * 10.1 ↘ 10.2 * 10.1 ↗
 beste Teiler 178.5 (21.) 179.2 (27.) 188.4 (29.)
 Trefferlage 0.38 mm rechts, 1.24 mm hoch
 Streuwert 2.30, horizontal: 2.39, vertikal: 2.20

Unterschrift des Schützen

Meyton Elektronik

Ergebnis: **303.1** (289)
 Serien: 99.9 99.8 103.4
 Zähler: 19 11 0 0 0 0 0 0 0 0
 Innenzehner: 16
 weiteste: 431 (11), 388 (13), 361 (4)
 beste Teiler 63.3 (12.) 70.0 (23.) 89.2 (21.)
 Trefferlage 0.24 mm rechts, 0.15 mm hoch
 Streuwert 1.67, horizontal: 1.82, vertikal: 1.51

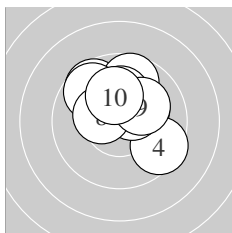
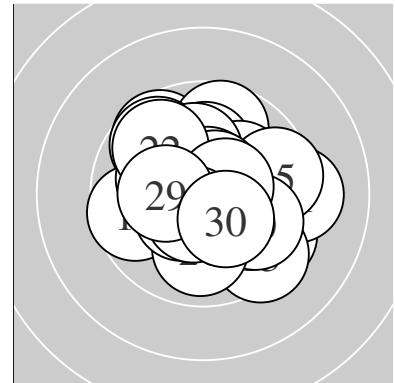

Serie 1:
 10.2 * 9.6 ↘ 9.7 ↑ 9.5 ↘ 9.7 ↘
 10.5 * 10.1 ↑ 10.4 * 10.1 ↗ 10.1 ↑
 beste Teiler 124.0 (6.) 147.3 (8.) 185.1 (1.)
 Trefferlage 0.23 mm rechts, 1.33 mm hoch
 Streuwert 1.57, horizontal: 1.72, vertikal: 1.42

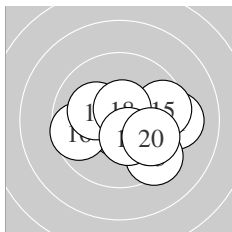

Serie 2:
 9.2 → 10.7 * 9.4 ↘ 10.2 * 9.6 →
 9.6 ← 10.2 * 10.6 * 10.4 * 9.9 ↘
 beste Teiler 63.3 (12.) 90.2 (18.) 143.1 (19.)
 Trefferlage 0.67 mm rechts, 0.45 mm tief
 Streuwert 1.94, horizontal: 2.48, vertikal: 1.17

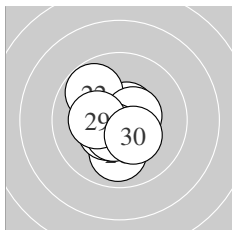

Serie 3:
 10.6 * 9.8 ↘ 10.7 * 10.4 * 10.5 *
 9.9 ↓ 10.4 * 10.5 * 10.3 * 10.3 *
 beste Teiler 70.0 (23.) 89.2 (21.) 105.5 (28.)
 Trefferlage 0.19 mm links, 0.40 mm tief
 Streuwert 1.19, horizontal: 1.09, vertikal: 1.29

Unterschrift des Schützen

Ergebnis: **307.7** (291)
 Serien: 103.8 102.1 101.8
 Zähler: 21 9 0 0 0 0 0 0 0 0
 Innenzehner: 20
 weiteste: 377 (29), 320 (24), 317 (20)
 beste Teiler 32.7 (30.) 43.1 (4.) 46.6 (3.)
 Trefferlage 0.21 mm links, 0.08 mm tief
 Streuwert 1.43, horizontal: 1.54, vertikal: 1.30

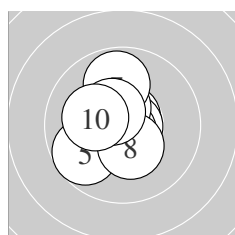
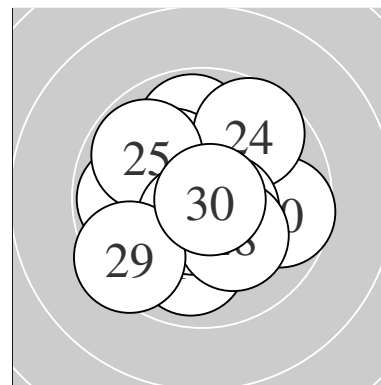

Serie 1:
 10.7 * 10.4 * 10.8 * 10.8 * 9.7 ↙
 10.5 * 9.8 ↑ 10.4 * 10.5 * 10.2 *
 beste Teiler 43.1 (4.) 46.6 (3.) 58.8 (1.)
 Trefferlage 0.57 mm links, 0.21 mm hoch
 Streuwert 1.16, horizontal: 1.02, vertikal: 1.29

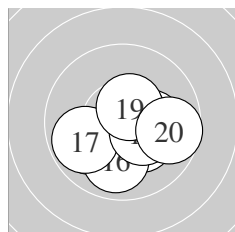

Serie 2:
 10.3 * 10.2 * 10.7 * 10.6 * 10.0 ↙
 9.9 ↓ 9.8 ↖ 10.4 * 10.5 * 9.7 →
 beste Teiler 63.6 (13.) 88.5 (14.) 111.4 (19.)
 Trefferlage 0.43 mm rechts, 0.58 mm tief
 Streuwert 1.42, horizontal: 1.73, vertikal: 1.01

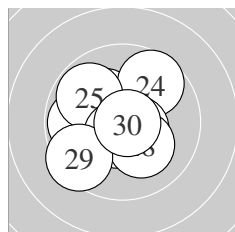

Serie 3:
 10.7 * 10.2 * 9.8 ← 9.7 ↗ 9.8 ↘
 10.6 * 10.6 * 10.2 * 9.4 ↙ 10.8 *
 beste Teiler 32.7 (30.) 71.1 (21.) 92.7 (27.)
 Trefferlage 0.50 mm links, 0.10 mm hoch
 Streuwert 1.62, horizontal: 1.71, vertikal: 1.52

Unterschrift des Schützen

Meyton Elektronik

Ergebnis: **296.5** (285)
 Serien: 96.5 100.4 99.6
 Zähler: 15 15 0 0 0 0 0 0 0 0
 Innenzehner: 8
 weiteste: 474 (2), 450 (5), 416 (22)
 beste Teiler 31.8 (19.) 69.2 (20.) 134.4 (30.)
 Trefferlage 0.94 mm rechts, 1.70 mm hoch
 Streuwert 1.54, horizontal: 1.79, vertikal: 1.24

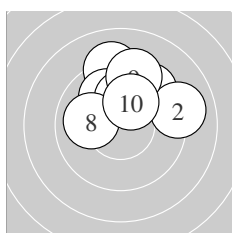
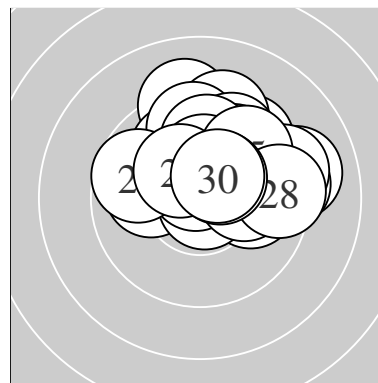

Serie 1:
 9.5 ↗ 9.1 → 10.0 ↑ 9.3 ↑ 9.2 ↑
 9.9 ↘ 10.1 ↑ 10.0 ← 9.3 ↑ 10.1 ↑
 beste Teiler 203.2 (10.) 214.3 (7.) 237.5 (8.)
 Trefferlage 0.47 mm rechts, 2.54 mm hoch
 Streuwert 1.64, horizontal: 1.93, vertikal: 1.30

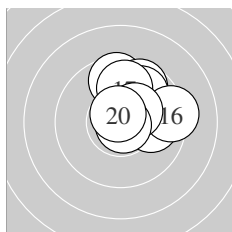

Serie 2:
 9.6 ↑ 10.2 * 10.0 → 9.7 ↗ 9.8 ↗
 9.3 → 9.9 ↑ 10.4 * 10.8 * 10.7 *
 beste Teiler 31.8 (19.) 69.2 (20.) 144.4 (18.)
 Trefferlage 1.13 mm rechts, 1.48 mm hoch
 Streuwert 1.31, horizontal: 1.34, vertikal: 1.28

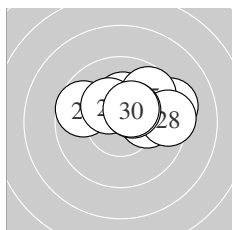

Serie 3:
 9.7 ↖ 9.3 → 10.2 * 10.1 → 9.7 ↗
 10.3 * 10.1 → 9.4 → 10.4 * 10.4 *
 beste Teiler 134.4 (30.) 137.1 (29.) 161.0 (26.)
 Trefferlage 1.21 mm rechts, 1.09 mm hoch
 Streuwert 1.55, horizontal: 2.11, vertikal: 0.60

Unterschrift des Schützen

Ergebnis: **303.9** (290)
 Serien: 103.6 99.2 101.1
 Zähler: 21 8 1 0 0 0 0 0 0 0
 Innenzehner: 14
 weiteste: 506 (15), 386 (28), 324 (3)
 beste Teiler 19.1 (23.) 35.6 (5.) 38.0 (19.)
 Trefferlage 0.63 mm links, 0.39 mm tief
 Streuwert 1.58, horizontal: 1.92, vertikal: 1.12

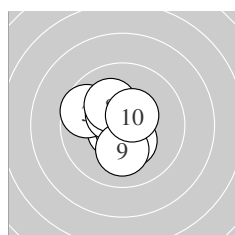
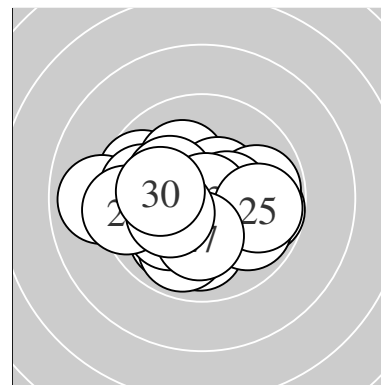

Serie 1:
 10.6 * 10.5 * 9.7 ↖ 10.4 * 10.8 *
 10.4 * 10.4 * 10.2 * 10.1 ↓ 10.5 *
 beste Teiler 35.6 (5.) 88.4 (1.) 109.8 (2.)
 Trefferlage 0.48 mm links, 0.06 mm hoch
 Streuwert 1.19, horizontal: 1.09, vertikal: 1.28

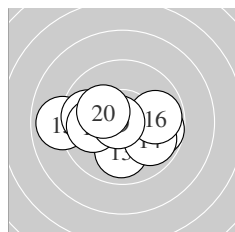

Serie 2:
 10.1 ← 9.7 → 10.0 ↓ 9.9 ↘ 8.9 ←
 9.8 → 9.8 ← 10.0 ← 10.8 * 10.2 *
 beste Teiler 38.0 (19.) 185.7 (20.) 212.7 (11.)
 Trefferlage 0.67 mm links, 0.33 mm tief
 Streuwert 2.02, horizontal: 2.68, vertikal: 0.98

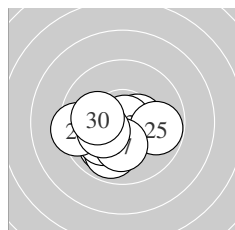

Serie 3:
 10.0 ↙ 10.5 * 10.9 * 9.9 ↓ 9.8 →
 10.1 ↙ 10.2 * 9.4 ← 10.2 * 10.1 ←
 beste Teiler 19.1 (23.) 125.4 (22.) 178.0 (29.)
 Trefferlage 0.74 mm links, 0.91 mm tief
 Streuwert 1.49, horizontal: 1.87, vertikal: 0.97

Unterschrift des Schützen

Ergebnis: **312.4** (297)
 Serien: 104.0 104.3 104.1
 Zähler: 27 3 0 0 0 0 0 0 0 0
 Innenzehner: 27
 weiteste: 301 (14), 291 (1), 253 (21)
 beste Teiler 31.0 (11.) 33.3 (2.) 58.1 (16.)
 Trefferlage 0.41 mm rechts, 0.65 mm hoch
 Streuwert 0.90, horizontal: 0.95, vertikal: 0.85

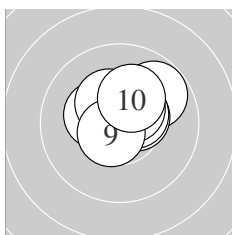
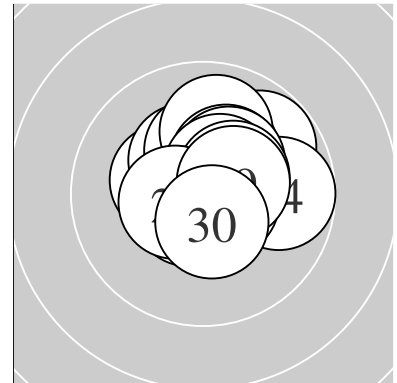

Serie 1:
 9.8 ↗ 10.8 * 10.5 * 10.3 * 10.3 *
 10.5 * 10.5 * 10.5 * 10.6 * 10.2 *
 beste Teiler 33.3 (2.) 84.2 (9.) 103.3 (3.)
 Trefferlage 0.31 mm rechts, 0.80 mm hoch
 Streuwert 0.92, horizontal: 1.07, vertikal: 0.73

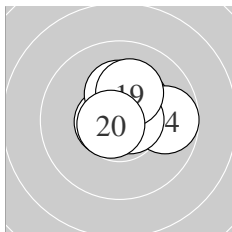

Serie 2:
 10.8 * 10.6 * 10.3 * 9.7 → 10.3 *
 10.7 * 10.7 * 10.3 * 10.2 * 10.7 *
 beste Teiler 31.0 (11.) 58.1 (16.) 63.9 (20.)
 Trefferlage 0.42 mm rechts, 0.66 mm hoch
 Streuwert 0.95, horizontal: 1.07, vertikal: 0.81

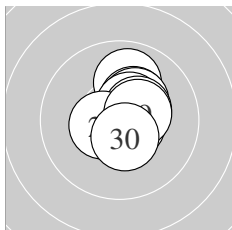

Serie 3:
 9.9 † 10.3 * 10.3 * 10.5 * 10.7 *
 10.4 * 10.6 * 10.5 * 10.4 * 10.5 *
 beste Teiler 75.6 (25.) 83.2 (27.) 114.6 (24.)
 Trefferlage 0.48 mm rechts, 0.49 mm hoch
 Streuwert 0.93, horizontal: 0.78, vertikal: 1.05

Unterschrift des Schützen

Ergebnis: **314.8** (300)
 Serien: 105.6 103.9 105.3
 Zähler: 30 0 0 0 0 0 0 0 0 0
 Innenzehner: 28
 weiteste: 243 (16), 220 (18), 196 (10)
 beste Teiler 7.0 (27.) 10.1 (22.) 38.6 (9.)
 Trefferlage 0.04 mm rechts, 0.20 mm tief
 Streuwert 0.90, horizontal: 0.95, vertikal: 0.85

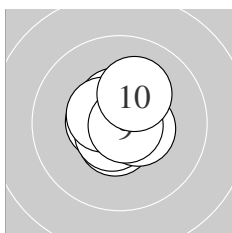
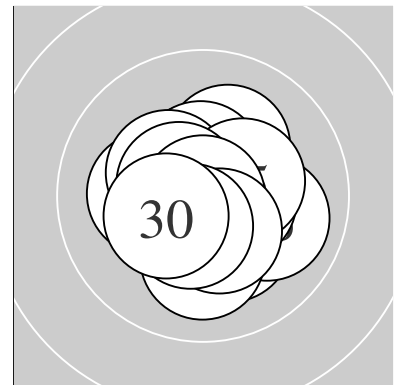

Serie 1:
 10.6 * 10.7 * 10.6 * 10.6 * 10.6 *
 10.5 * 10.5 * 10.5 * 10.8 * 10.2 *
 beste Teiler 38.6 (9.) 66.2 (2.) 77.4 (5.)
 Trefferlage 0.15 mm links, 0.13 mm hoch
 Streuwert 0.78, horizontal: 0.72, vertikal: 0.84

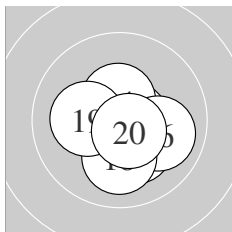

Serie 2:
 10.7 * 10.7 * 10.2 * 10.5 * 10.3 *
 10.0 → 10.6 * 10.1 ↓ 10.2 * 10.6 *
 beste Teiler 52.4 (11.) 69.1 (12.) 84.3 (17.)
 Trefferlage 0.46 mm rechts, 0.54 mm tief
 Streuwert 1.02, horizontal: 1.08, vertikal: 0.95

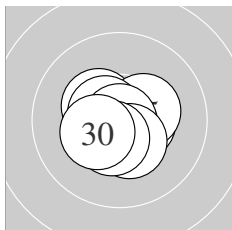

Serie 3:
 10.5 * 10.9 * 10.5 * 10.4 * 10.3 *
 10.6 * 10.9 * 10.4 * 10.5 * 10.3 *
 beste Teiler 7.0 (27.) 10.1 (22.) 96.1 (26.)
 Trefferlage 0.18 mm links, 0.20 mm tief
 Streuwert 0.85, horizontal: 0.97, vertikal: 0.70

Unterschrift des Schützen

Ergebnis: **300.1** (289)
 Serien: 98.4 100.5 101.2
 Zähler: 19 11 0 0 0 0 0 0 0 0
 Innenzehner: 13
 weiteste: 469 (21), 454 (8), 419 (7)
 beste Teiler 87.1 (27.) 97.4 (17.) 116.1 (28.)
 Trefferlage 0.02 mm rechts, 1.30 mm tief
 Streuwert 1.60, horizontal: 1.52, vertikal: 1.67

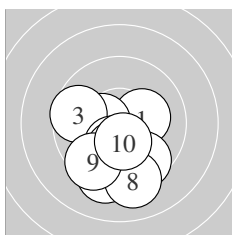
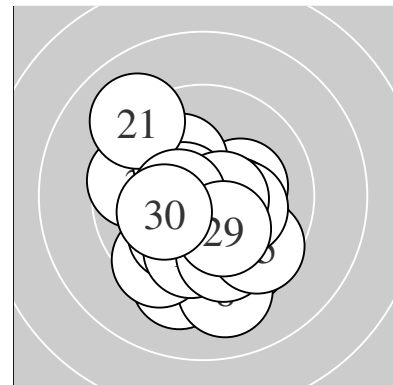

Serie 1:
 10.2 * 10.4 * 9.6 ↖ 10.2 * 9.6 ↘
 10.1 ↓ 9.3 ↓ 9.1 ↓ 9.5 ✓ 10.4 *
 beste Teiler 138.2 (2.) 146.5 (10.) 176.4 (4.)
 Trefferlage 0.38 mm links, 1.82 mm tief
 Streuwert 1.73, horizontal: 1.65, vertikal: 1.82

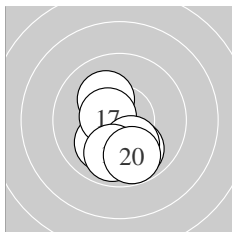

Serie 2:
 10.0 ↓ 9.9 ↓ 10.2 * 10.1 ✓ 9.9 ↘
 10.0 ↓ 10.6 * 10.1 ↓ 9.9 ↓ 9.8 ↓
 beste Teiler 97.4 (17.) 196.3 (13.) 209.8 (18.)
 Trefferlage 0.04 mm rechts, 1.62 mm tief
 Streuwert 1.23, horizontal: 0.99, vertikal: 1.43

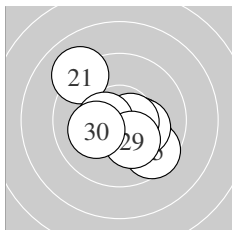

Serie 3:
 9.1 ↖ 10.0 ↘ 10.4 * 10.4 * 9.6 ↘
 10.2 * 10.6 * 10.5 * 10.2 * 10.2 *
 beste Teiler 87.1 (27.) 116.1 (28.) 135.4 (23.)
 Trefferlage 0.42 mm rechts, 0.46 mm tief
 Streuwert 1.71, horizontal: 1.83, vertikal: 1.57

Unterschrift des Schützen

Ergebnis: **309.4** (298)
 Serien: 103.4 103.6 102.4
 Zähler: 28 2 0 0 0 0 0 0 0 0
 Innenzehner: 21
 weiteste: 351 (10), 323 (6), 250 (27)
 beste Teiler 44.2 (15.) 49.0 (26.) 69.4 (5.)
 Trefferlage 0.26 mm links, 0.15 mm hoch
 Streuwert 1.25, horizontal: 1.34, vertikal: 1.15

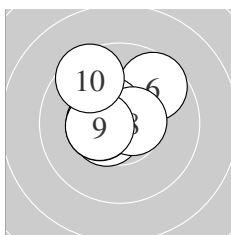
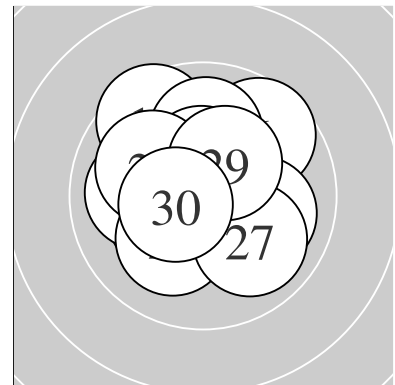

Serie 1:
 10.5 * 10.5 * 10.6 * 10.4 * 10.7 *
 9.7 ↗ 10.5 * 10.6 * 10.4 * 9.5 ↘
 beste Teiler 69.4 (5.) 85.5 (3.) 85.9 (8.)
 Trefferlage 0.55 mm links, 0.62 mm hoch
 Streuwert 1.18, horizontal: 1.21, vertikal: 1.15

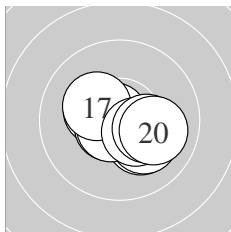

Serie 2:
 10.2 * 10.1 ↘ 10.3 * 10.6 * 10.8 *
 10.7 * 10.3 * 10.4 * 10.2 * 10.0 →
 beste Teiler 44.2 (15.) 74.5 (16.) 83.3 (14.)
 Trefferlage 0.34 mm rechts, 0.37 mm tief
 Streuwert 1.12, horizontal: 1.40, vertikal: 0.75

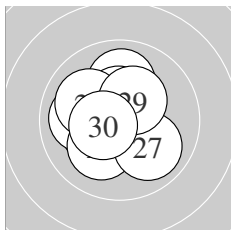

Serie 3:
 10.3 * 10.0 ← 10.1 ↗ 10.0 ↑ 10.4 *
 10.8 * 10.0 ↘ 10.0 ↖ 10.3 * 10.5 *
 beste Teiler 49.0 (26.) 113.2 (30.) 129.1 (25.)
 Trefferlage 0.58 mm links, 0.20 mm hoch
 Streuwert 1.33, horizontal: 1.31, vertikal: 1.36

Unterschrift des Schützen

Ergebnis: **304.3** (292)
 Serien: 102.1 102.3 99.9
 Zähler: 22 8 0 0 0 0 0 0 0 0
 Innenzehner: 15
 weiteste: 413 (29), 385 (5), 375 (28)
 beste Teiler 17.0 (7.) 51.8 (3.) 64.8 (16.)
 Trefferlage 0.02 mm rechts, 0.34 mm hoch
 Streuwert 1.60, horizontal: 1.62, vertikal: 1.58

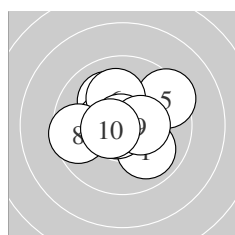
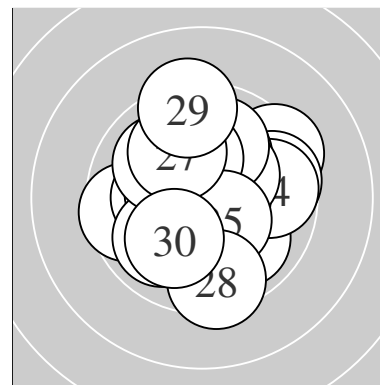

Serie 1:
 9.9 ↘ 10.1 ↖ 10.7 * 10.4 * 9.4 ↗
 10.1 ↑ 10.9 * 9.6 ← 10.4 * 10.6 *
 beste Teiler 17.0 (7.) 51.8 (3.) 96.5 (10.)
 Trefferlage 0.13 mm links, 0.31 mm hoch
 Streuwert 1.59, horizontal: 1.86, vertikal: 1.27

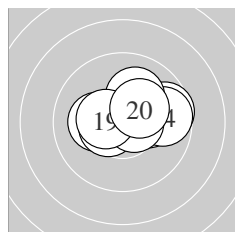

Serie 2:
 9.6 → 10.2 * 10.2 * 9.7 → 10.5 *
 10.7 * 10.6 * 10.1 ↑ 10.4 * 10.3 *
 beste Teiler 64.8 (16.) 87.0 (17.) 113.8 (15.)
 Trefferlage 0.74 mm rechts, 0.47 mm hoch
 Streuwert 1.32, horizontal: 1.74, vertikal: 0.65

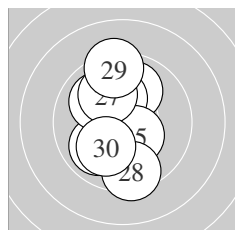

Serie 3:
 10.0 ↑ 10.5 * 9.9 ↙ 10.2 * 10.4 *
 10.0 ↘ 10.0 ↖ 9.5 ↓ 9.3 ↑ 10.1 ↘
 beste Teiler 120.3 (22.) 135.2 (25.) 182.7 (24.)
 Trefferlage 0.52 mm links, 0.24 mm hoch
 Streuwert 1.88, horizontal: 1.03, vertikal: 2.45

Unterschrift des Schützen

Meyton Elektronik

Ergebnis: **299.5** (288)
 Serien: 100.3 99.2 100.0
 Zähler: 18 12 0 0 0 0 0 0 0 0
 Innenzehner: 13
 weiteste: 497 (1), 469 (13), 444 (19)
 beste Teiler 43.9 (12.) 59.3 (9.) 64.7 (5.)
 Trefferlage 0.16 mm links, 0.17 mm tief
 Streuwert 1.96, horizontal: 2.15, vertikal: 1.74

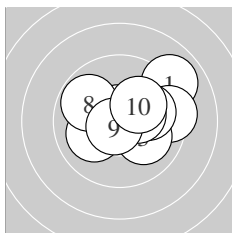
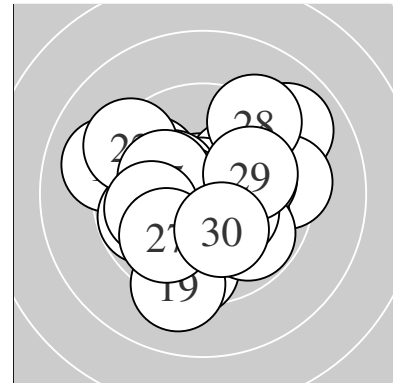

Serie 1:
 9.0 ↗ 9.4 → 10.1 ↘ 10.0 → 10.7 *
 10.3 * 10.1 ← 9.8 ↖ 10.7 * 10.2 *
 beste Teiler 59.3 (9.) 64.7 (5.) 151.4 (6.)
 Trefferlage 0.99 mm rechts, 0.56 mm hoch
 Streuwert 1.79, horizontal: 2.21, vertikal: 1.24

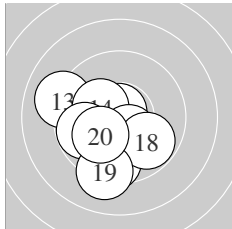

Serie 2:
 10.2 * 10.8 * 9.1 ↖ 10.3 * 10.4 *
 9.8 ← 9.5 ↓ 9.8 ↘ 9.2 ↓ 10.1 ↙
 beste Teiler 43.9 (12.) 145.6 (15.) 170.4 (14.)
 Trefferlage 0.95 mm links, 1.27 mm tief
 Streuwert 1.82, horizontal: 1.83, vertikal: 1.80

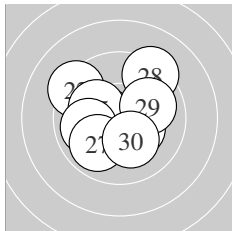

Serie 3:
 10.3 * 9.3 ↖ 10.6 * 10.3 * 10.2 *
 9.9 ← 9.9 ↙ 9.3 ↗ 10.0 → 10.2 *
 beste Teiler 97.1 (23.) 159.6 (24.) 173.7 (21.)
 Trefferlage 0.51 mm links, 0.20 mm hoch
 Streuwert 1.90, horizontal: 2.08, vertikal: 1.70

Unterschrift des Schützen

Ergebnis: **304.9** (292)
 Serien: 102.8 100.1 102.0
 Zähler: 22 8 0 0 0 0 0 0 0 0
 Innenzehner: 13
 weiteste: 329 (20), 309 (17), 300 (27)
 beste Teiler 65.1 (26.) 74.9 (2.) 77.9 (28.)
 Trefferlage 0.09 mm rechts, 0.02 mm hoch
 Streuwert 1.51, horizontal: 1.75, vertikal: 1.21

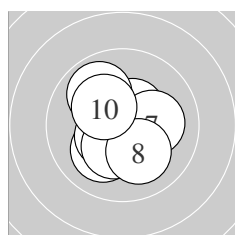
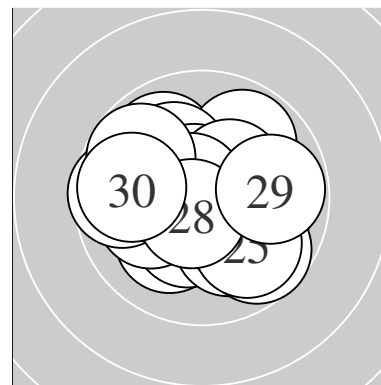

Serie 1:
 10.1 ↙ 10.7 * 10.5 * 10.5 * 10.4 *
 10.3 * 10.1 → 10.1 ↘ 9.9 ↖ 10.2 *
 beste Teiler 74.9 (2.) 103.6 (3.) 117.6 (4.)
 Trefferlage 0.19 mm links, 0.19 mm tief
 Streuwert 1.29, horizontal: 1.25, vertikal: 1.32

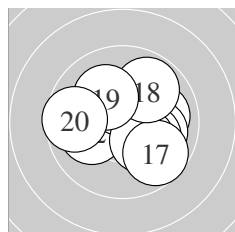

Serie 2:
 10.0 → 10.1 ← 10.0 ↘ 10.4 * 10.1 ↘
 10.2 * 9.7 ↘ 9.9 ↗ 10.1 ↖ 9.6 ←
 beste Teiler 129.1 (14.) 183.9 (16.) 205.1 (15.)
 Trefferlage 0.50 mm rechts, 0.00 mm
 Streuwert 1.75, horizontal: 2.04, vertikal: 1.40

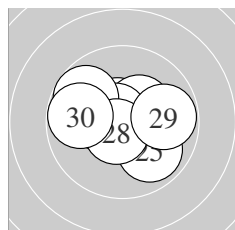

Serie 3:
 10.1 → 10.3 * 10.6 * 10.4 * 9.9 ↘
 10.7 * 9.8 ↖ 10.6 * 9.8 → 9.8 ←
 beste Teiler 65.1 (26.) 77.9 (28.) 86.9 (23.)
 Trefferlage 0.02 mm links, 0.24 mm hoch
 Streuwert 1.55, horizontal: 1.97, vertikal: 0.96

Unterschrift des Schützen

Meyton Elektronik

Ergebnis: **299.8** (288)
 Serien: 97.8 100.4 101.6
 Zähler: 20 8 2 0 0 0 0 0 0 0
 Innenzehner: 12
 weiteste: 603 (9), 528 (20), 491 (25)
 beste Teiler 69.2 (27.) 75.9 (21.) 86.8 (24.)
 Trefferlage 0.82 mm rechts, 0.81 mm hoch
 Streuwert 1.77, horizontal: 2.08, vertikal: 1.39

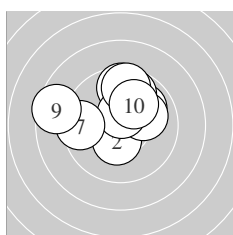
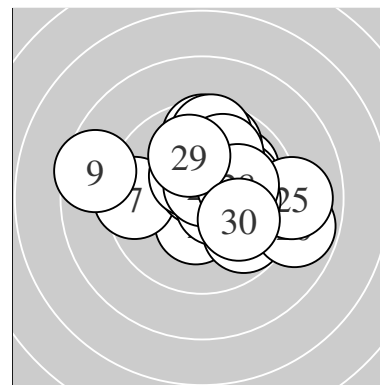

Serie 1:
 9.9 ↗ 10.4 * 9.7 ↑ 9.6 ↑ 10.1 →
 10.5 * 9.5 ← 9.6 ↑ 8.5 ← 10.0 ↗
 beste Teiler 104.4 (6.) 143.0 (2.) 224.3 (5.)
 Trefferlage 0.29 mm links, 1.51 mm hoch
 Streuwert 2.09, horizontal: 2.54, vertikal: 1.51

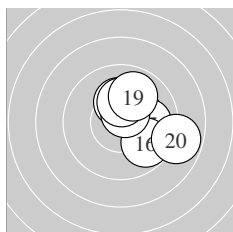

Serie 2:
 10.3 * 10.3 * 10.3 * 10.2 * 10.0 →
 9.8 ↘ 10.6 * 10.2 * 9.9 ↑ 8.8 →
 beste Teiler 93.9 (17.) 170.0 (11.) 172.4 (12.)
 Trefferlage 1.50 mm rechts, 0.62 mm hoch
 Streuwert 1.47, horizontal: 1.52, vertikal: 1.42

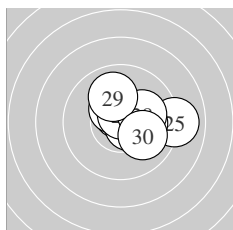

Serie 3:
 10.7 * 10.0 → 10.4 * 10.6 * 9.0 →
 10.1 → 10.7 * 10.1 → 10.0 ↑ 10.0 ↘
 beste Teiler 69.2 (27.) 75.9 (21.) 86.8 (24.)
 Trefferlage 1.25 mm rechts, 0.32 mm hoch
 Streuwert 1.42, horizontal: 1.73, vertikal: 1.02

Unterschrift des Schützen

Meyton Elektronik

Ergebnis: **300.6** (288)
 Serien: 99.7 101.0 99.9
 Zähler: 19 10 1 0 0 0 0 0 0 0
 Innenzehner: 13
 weiteste: 545 (28), 400 (15), 398 (6)
 beste Teiler 64.8 (17.) 89.0 (9.) 90.4 (10.)
 Trefferlage 0.16 mm links, 0.81 mm hoch
 Streuwert 1.77, horizontal: 1.71, vertikal: 1.82

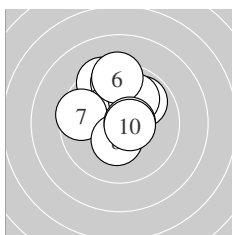
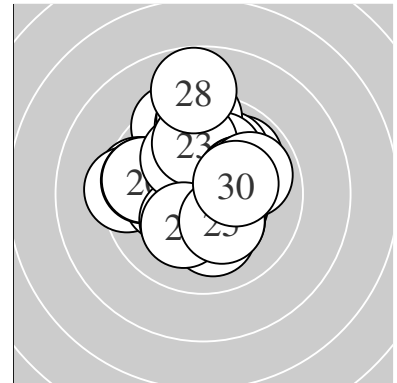

Serie 1:
 9.4 ↖ 9.9 ↗ 9.5 ↑ 10.3 * 10.0 ↗
 9.4 ↑ 9.6 ← 10.4 * 10.6 * 10.6 *
 beste Teiler 89.0 (9.) 90.4 (10.) 148.1 (8.)
 Trefferlage 0.11 mm links, 1.56 mm hoch
 Streuwert 1.67, horizontal: 1.52, vertikal: 1.80

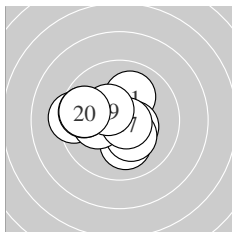

Serie 2:
 10.1 ↗ 10.1 ↓ 10.4 * 10.3 * 9.4 ←
 10.2 * 10.7 * 9.7 ← 10.4 * 9.7 ←
 beste Teiler 64.8 (17.) 130.6 (13.) 133.7 (19.)
 Trefferlage 0.88 mm links, 0.00 mm
 Streuwert 1.64, horizontal: 1.99, vertikal: 1.19

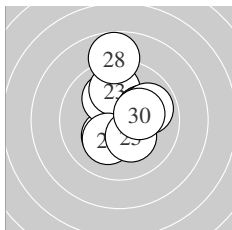

Serie 3:
 10.3 * 10.1 ↖ 9.9 ↑ 10.2 * 10.3 *
 10.1 → 10.1 → 8.8 ↑ 9.9 → 10.2 *
 beste Teiler 173.1 (25.) 174.9 (21.) 180.2 (30.)
 Trefferlage 0.49 mm rechts, 0.86 mm hoch
 Streuwert 1.84, horizontal: 1.45, vertikal: 2.15

Unterschrift des Schützen

Ergebnis: **288.2** (275)
 Serien: 97.6 93.5 97.1
 Zähler: 12 11 7 0 0 0 0 0 0 0
 Innenzehner: 8
 weiteste: 730 (17), 660 (22), 635 (14)
 beste Teiler 53.4 (13.) 116.9 (5.) 130.2 (26.)
 Trefferlage 1.74 mm links, 1.16 mm hoch
 Streuwert 2.28, horizontal: 2.68, vertikal: 1.79

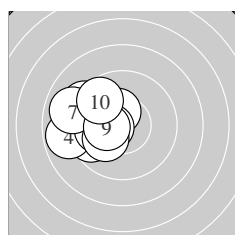
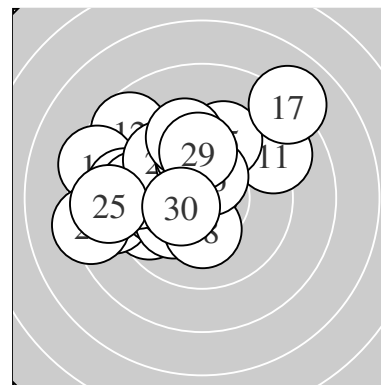

Serie 1:
 9.3 ↘ 9.6 ← 10.4 * 8.8 ← 10.5 *
 10.0 ← 8.9 ↘ 10.1 ↙ 10.3 * 9.7 ↘
 beste Teiler 116.9 (5.) 139.5 (3.) 153.1 (9.)
 Trefferlage 2.60 mm links, 0.27 mm hoch
 Streuwert 1.47, horizontal: 1.55, vertikal: 1.38

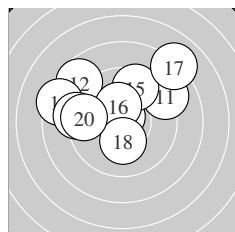

Serie 2:
 9.0 ↗ 8.7 ↘ 10.7 * 8.4 ↖ 9.5 ↗
 10.3 * 8.0 ↗ 10.2 * 9.2 ← 9.5 ←
 beste Teiler 53.4 (13.) 163.4 (16.) 181.0 (18.)
 Trefferlage 0.85 mm links, 1.83 mm hoch
 Streuwert 2.99, horizontal: 3.70, vertikal: 2.05

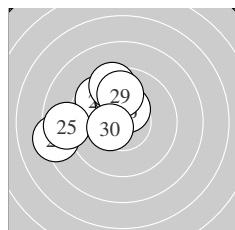

Serie 3:
 10.1 ↑ 8.3 ← 9.7 ↘ 10.1 ↑ 8.8 ←
 10.4 * 9.9 ↑ 9.5 ↑ 9.9 ↑ 10.4 *
 beste Teiler 130.2 (26.) 130.9 (30.) 204.3 (24.)
 Trefferlage 1.77 mm links, 1.39 mm hoch
 Streuwert 2.00, horizontal: 2.30, vertikal: 1.65

Unterschrift des Schützen

Meyton Elektronik

Ergebnis: **314.7** (299)
 Serien: 104.6 105.2 104.9
 Zähler: 29 1 0 0 0 0 0 0 0 0
 Innenzehner: 29
 weiteste: 328 (6), 180 (3), 165 (12)
 beste Teiler 32.5 (8.) 35.0 (18.) 48.7 (10.)
 Trefferlage 0.29 mm links, 0.12 mm hoch
 Streuwert 0.88, horizontal: 0.96, vertikal: 0.80

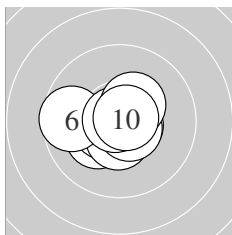
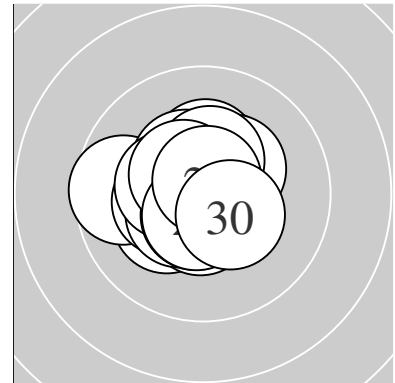

Serie 1:
 10.6 * 10.6 * 10.2 * 10.5 * 10.5 *
 9.6 ← 10.6 * 10.8 * 10.4 * 10.8 *
 beste Teiler 32.5 (8.) 48.7 (10.) 80.0 (2.)
 Trefferlage 0.42 mm links, 0.21 mm tief
 Streuwert 1.02, horizontal: 1.29, vertikal: 0.65

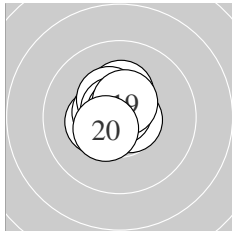

Serie 2:
 10.5 * 10.3 * 10.3 * 10.5 * 10.4 *
 10.7 * 10.7 * 10.8 * 10.5 * 10.5 *
 beste Teiler 35.0 (18.) 66.7 (16.) 71.5 (17.)
 Trefferlage 0.32 mm links, 0.49 mm hoch
 Streuwert 0.74, horizontal: 0.71, vertikal: 0.77

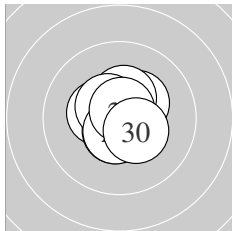

Serie 3:
 10.3 * 10.4 * 10.4 * 10.6 * 10.4 *
 10.6 * 10.5 * 10.6 * 10.7 * 10.4 *
 beste Teiler 57.2 (29.) 79.3 (24.) 93.0 (28.)
 Trefferlage 0.12 mm links, 0.10 mm hoch
 Streuwert 0.88, horizontal: 0.87, vertikal: 0.88

Unterschrift des Schützen

Ergebnis: **311.6** (299)
 Serien: 105.0 103.8 102.8
 Zähler: 29 1 0 0 0 0 0 0 0 0
 Innenzehner: 22
 weiteste: 272 (20), 250 (27), 241 (24)
 beste Teiler 43.8 (19.) 47.4 (6.) 55.1 (25.)
 Trefferlage 0.18 mm links, 0.37 mm hoch
 Streuwert 1.09, horizontal: 0.94, vertikal: 1.22

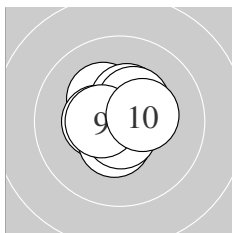
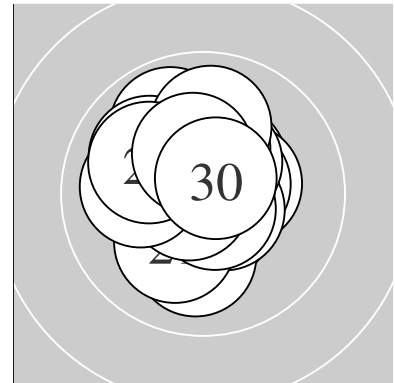

Serie 1:
 10.3 * 10.4 * 10.4 * 10.6 * 10.5 *
 10.8 * 10.4 * 10.7 * 10.5 * 10.4 *
 beste Teiler 47.4 (6.) 69.4 (8.) 98.3 (4.)
 Trefferlage 0.09 mm links, 0.08 mm hoch
 Streuwert 0.91, horizontal: 0.88, vertikal: 0.94

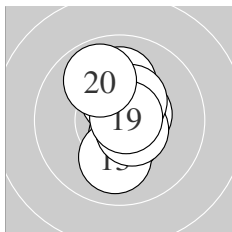

Serie 2:
 10.5 * 10.5 * 10.0 ↓ 10.4 * 10.7 *
 10.6 * 10.0 ↑ 10.4 * 10.8 * 9.9 ↘
 beste Teiler 43.8 (19.) 61.0 (15.) 96.4 (16.)
 Trefferlage 0.21 mm rechts, 0.38 mm hoch
 Streuwert 1.14, horizontal: 0.65, vertikal: 1.47

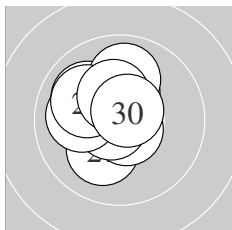

Serie 3:
 10.1 ↙ 10.3 * 10.7 * 10.0 ↘ 10.7 *
 10.0 ← 10.0 ↑ 10.0 ↘ 10.3 * 10.7 *
 beste Teiler 55.1 (25.) 71.2 (23.) 74.6 (30.)
 Trefferlage 0.67 mm links, 0.64 mm hoch
 Streuwert 1.18, horizontal: 1.09, vertikal: 1.26

Unterschrift des Schützen

Ergebnis: **311.1** (298)
 Serien: 102.6 103.6 104.9
 Zähler: 28 2 0 0 0 0 0 0 0 0
 Innenzehner: 23
 weiteste: 418 (10), 314 (4), 245 (19)
 beste Teiler 16.1 (29.) 50.9 (12.) 51.0 (27.)
 Trefferlage 0.03 mm rechts, 0.16 mm hoch
 Streuwert 1.21, horizontal: 1.47, vertikal: 0.87

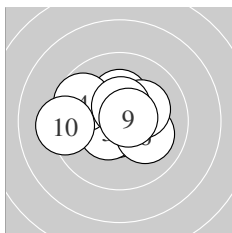
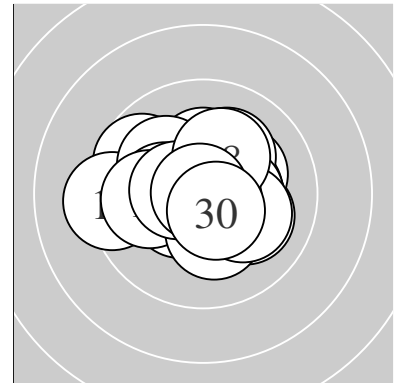

Serie 1:
 10.3 * 10.7 * 10.5 * 9.7 ↖ 10.6 *
 10.1 ↗ 10.2 * 10.5 * 10.7 * 9.3 ←
 beste Teiler 58.3 (2.) 72.2 (9.) 99.0 (5.)
 Trefferlage 0.30 mm links, 0.36 mm hoch
 Streuwert 1.51, horizontal: 1.90, vertikal: 0.96

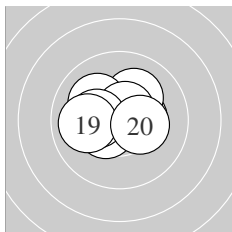

Serie 2:
 10.4 * 10.8 * 10.5 * 10.1 ↗ 10.5 *
 10.1 ↖ 10.6 * 10.3 * 10.0 ← 10.3 *
 beste Teiler 50.9 (12.) 82.4 (17.) 110.0 (13.)
 Trefferlage 0.18 mm links, 0.33 mm hoch
 Streuwert 1.17, horizontal: 1.48, vertikal: 0.74

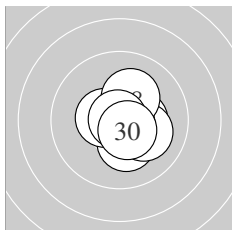

Serie 3:
 10.5 * 10.3 * 10.5 * 10.4 * 10.7 *
 10.1 ↗ 10.7 * 10.2 * 10.9 * 10.6 *
 beste Teiler 16.1 (29.) 51.0 (27.) 54.4 (25.)
 Trefferlage 0.58 mm rechts, 0.19 mm tief
 Streuwert 0.85, horizontal: 0.83, vertikal: 0.87

Unterschrift des Schützen

Ergebnis: **305.6** (292)
 Serien: 102.0 99.1 104.5
 Zähler: 23 6 1 0 0 0 0 0 0 0
 Innenzehner: 19
 weiteste: 509 (16), 462 (2), 373 (17)
 beste Teiler 37.1 (21.) 78.2 (3.) 79.6 (19.)
 Trefferlage 0.61 mm rechts, 0.59 mm tief
 Streuwert 1.48, horizontal: 1.68, vertikal: 1.26

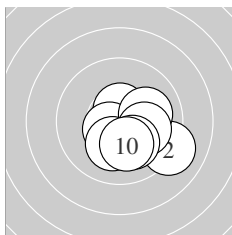
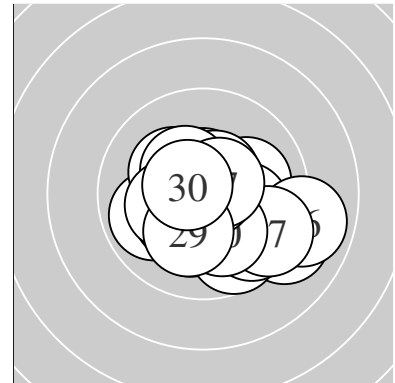

Serie 1:
 10.5 * 9.1 ↘ 10.6 * 10.6 * 10.5 *
 10.1 → 10.2 * 10.1 → 10.1 ↓ 10.2 *
 beste Teiler 78.2 (3.) 92.0 (4.) 106.0 (5.)
 Trefferlage 1.00 mm rechts, 0.67 mm tief
 Streuwert 1.34, horizontal: 1.46, vertikal: 1.21

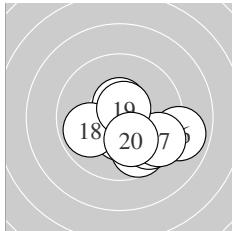

Serie 2:
 9.8 ↘ 9.7 ↘ 10.5 * 10.4 * 9.7 ↘
 8.9 → 9.5 ↘ 9.9 ← 10.6 * 10.1 ↓
 beste Teiler 79.6 (19.) 103.0 (13.) 137.0 (14.)
 Trefferlage 1.30 mm rechts, 1.26 mm tief
 Streuwert 1.67, horizontal: 2.03, vertikal: 1.22

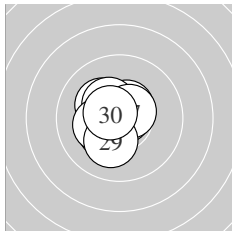

Serie 3:
 10.8 * 10.6 * 10.3 * 10.2 * 10.5 *
 10.4 * 10.6 * 10.3 * 10.2 * 10.6 *
 beste Teiler 37.1 (21.) 88.2 (22.) 89.5 (30.)
 Trefferlage 0.48 mm links, 0.16 mm hoch
 Streuwert 0.95, horizontal: 0.89, vertikal: 1.01

Unterschrift des Schützen

Ergebnis: **310.3** (297)
 Serien: 102.8 104.2 103.3
 Zähler: 27 3 0 0 0 0 0 0 0 0
 Innenzehner: 25
 weiteste: 339 (22), 309 (6), 272 (9)
 beste Teiler 35.4 (1.) 59.5 (17.) 87.0 (8.)
 Trefferlage 0.25 mm links, 0.63 mm tief
 Streuwert 1.09, horizontal: 1.31, vertikal: 0.83

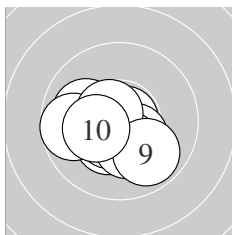
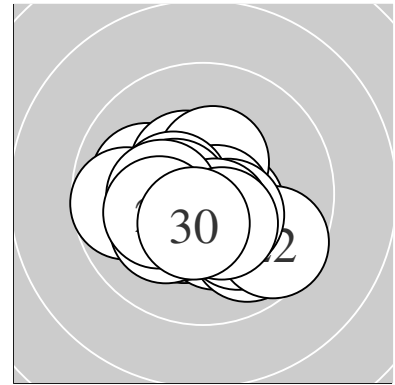

Serie 1:
 10.8 * 10.3 * 10.0 ← 10.4 * 10.5 *
 9.7 ← 10.3 * 10.6 * 9.9 ↘ 10.3 *
 beste Teiler 35.4 (1.) 87.0 (8.) 113.8 (5.)
 Trefferlage 0.54 mm links, 0.65 mm tief
 Streuwert 1.23, horizontal: 1.49, vertikal: 0.89

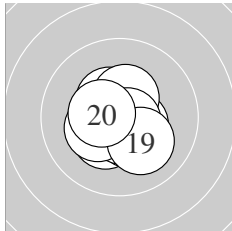

Serie 2:
 10.3 * 10.4 * 10.5 * 10.6 * 10.4 *
 10.4 * 10.7 * 10.3 * 10.1 ↘ 10.5 *
 beste Teiler 59.5 (17.) 92.9 (14.) 112.6 (13.)
 Trefferlage 0.00 mm , 0.37 mm tief
 Streuwert 0.98, horizontal: 0.99, vertikal: 0.97

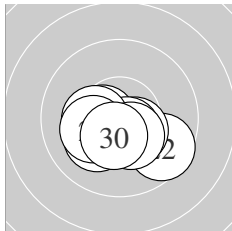

Serie 3:
 10.6 * 9.6 ↘ 10.5 * 10.4 * 10.2 *
 10.6 * 10.3 * 10.2 * 10.4 * 10.5 *
 beste Teiler 93.1 (21.) 95.3 (26.) 113.0 (23.)
 Trefferlage 0.22 mm links, 0.85 mm tief
 Streuwert 1.11, horizontal: 1.46, vertikal: 0.59

Unterschrift des Schützen

Ergebnis: **307.5** (292)
 Serien: 104.0 102.8 100.7
 Zähler: 22 8 0 0 0 0 0 0 0 0
 Innenzehner: 18
 weiteste: 433 (30), 362 (10), 360 (20)
 beste Teiler 13.3 (14.) 17.8 (9.) 18.4 (5.)
 Trefferlage 0.24 mm rechts, 0.33 mm tief
 Streuwert 1.47, horizontal: 1.54, vertikal: 1.40

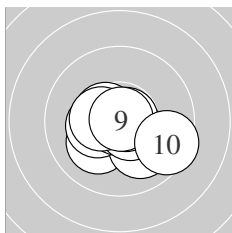
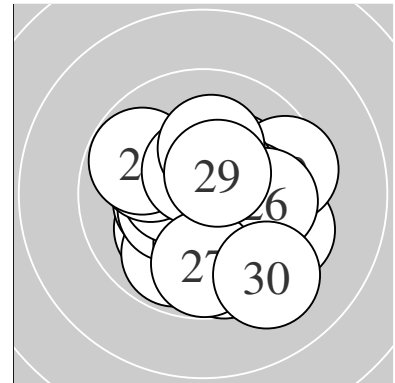

Serie 1:
 10.1 ↙ 10.0 ↘ 10.5 * 10.3 * 10.9 *
 10.6 * 10.8 * 10.4 * 10.9 * 9.5 ↘
 beste Teiler 17.8 (9.) 18.4 (5.) 46.5 (7.)
 Trefferlage 0.06 mm rechts, 0.48 mm tief
 Streuwert 1.22, horizontal: 1.53, vertikal: 0.81

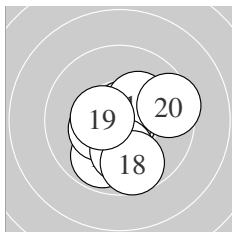

Serie 2:
 10.7 * 10.8 * 9.9 ↙ 10.9 * 10.4 *
 10.3 * 10.1 ↓ 9.7 ↓ 10.5 * 9.5 →
 beste Teiler 13.3 (14.) 34.4 (12.) 65.7 (11.)
 Trefferlage 0.27 mm rechts, 0.55 mm tief
 Streuwert 1.46, horizontal: 1.44, vertikal: 1.48

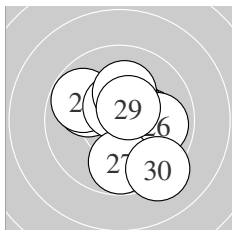

Serie 3:
 10.0 ↖ 10.2 * 10.5 * 9.8 ↖ 10.6 *
 9.9 → 9.8 ↓ 10.2 * 10.5 * 9.2 ↘
 beste Teiler 100.5 (25.) 106.2 (29.) 113.8 (23.)
 Trefferlage 0.39 mm rechts, 0.02 mm hoch
 Streuwert 1.79, horizontal: 1.78, vertikal: 1.80

Unterschrift des Schützen

Ergebnis: **309.9** (296)
 Serien: 103.1 102.5 104.3
 Zähler: 26 4 0 0 0 0 0 0 0 0
 Innenzehner: 19
 weiteste: 382 (21), 339 (13), 298 (16)
 beste Teiler 17.0 (19.) 35.1 (7.) 41.4 (15.)
 Trefferlage 0.40 mm links, 0.16 mm hoch
 Streuwert 1.28, horizontal: 0.89, vertikal: 1.58

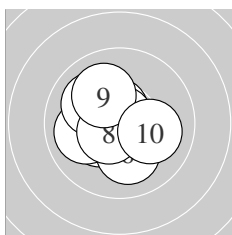
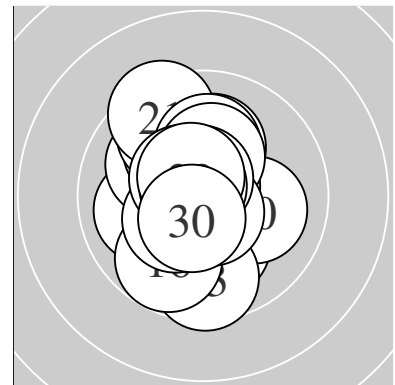

Serie 1:
 10.3 * 10.6 * 10.5 * 10.0 ← 10.0 ↘
 10.1 ↓ 10.8 * 10.6 * 10.1 ↖ 10.1 →
 beste Teiler 35.1 (7.) 95.2 (8.) 96.5 (2.)
 Trefferlage 0.48 mm links, 0.10 mm tief
 Streuwert 1.25, horizontal: 1.29, vertikal: 1.21

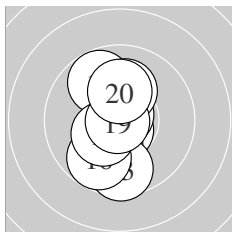

Serie 2:
 10.7 * 10.2 * 9.6 ↓ 9.8 ↗ 10.8 *
 9.8 ↙ 10.4 * 10.1 ↑ 10.9 * 10.2 *
 beste Teiler 17.0 (19.) 41.4 (15.) 69.0 (11.)
 Trefferlage 0.40 mm links, 0.24 mm tief
 Streuwert 1.52, horizontal: 0.69, vertikal: 2.04

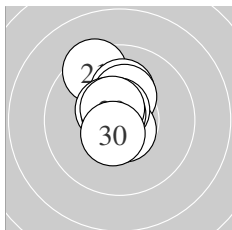

Serie 3:
 9.4 ↖ 10.1 ↑ 10.8 * 10.3 * 10.5 *
 10.7 * 10.7 * 10.7 * 10.6 * 10.5 *
 beste Teiler 47.0 (23.) 58.6 (28.) 72.5 (27.)
 Trefferlage 0.33 mm links, 0.85 mm hoch
 Streuwert 1.00, horizontal: 0.63, vertikal: 1.27

Unterschrift des Schützen

Ergebnis: **306.5** (293)
 Serien: 100.7 103.4 102.4
 Zähler: 23 7 0 0 0 0 0 0 0 0
 Innenzehner: 19
 weiteste: 330 (4), 294 (28), 290 (3)
 beste Teiler 16.0 (13.) 55.0 (22.) 77.2 (17.)
 Trefferlage 0.38 mm rechts, 1.04 mm hoch
 Streuwert 1.19, horizontal: 1.29, vertikal: 1.09

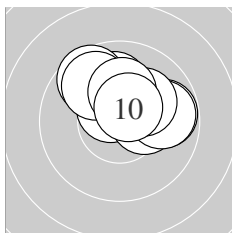
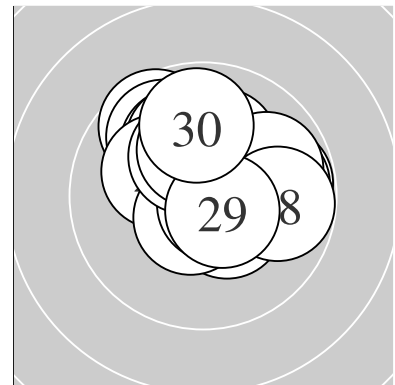

Serie 1:
 10.5 * 10.0 ↑ 9.8 → 9.6 ↘ 10.3 *
 9.8 → 10.2 * 9.8 ↘ 10.2 * 10.5 *
 beste Teiler 102.9 (1.) 107.3 (10.) 162.1 (5.)
 Trefferlage 0.51 mm rechts, 1.33 mm hoch
 Streuwert 1.34, horizontal: 1.66, vertikal: 0.93

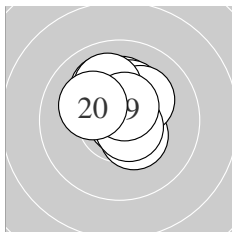

Serie 2:
 10.4 * 10.1 ↘ 10.9 * 10.2 * 10.2 *
 10.2 * 10.6 * 10.0 ↘ 10.6 * 10.2 *
 beste Teiler 16.0 (13.) 77.2 (17.) 94.9 (19.)
 Trefferlage 0.06 mm rechts, 0.94 mm hoch
 Streuwert 1.03, horizontal: 0.96, vertikal: 1.10

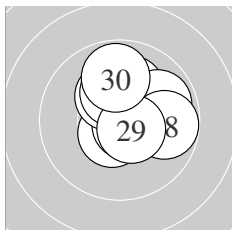

Serie 3:
 10.6 * 10.7 * 10.4 * 10.3 * 10.1 ↗
 10.2 * 9.9 → 9.8 → 10.6 * 9.8 ↑
 beste Teiler 55.0 (22.) 95.6 (29.) 98.1 (21.)
 Trefferlage 0.56 mm rechts, 0.84 mm hoch
 Streuwert 1.25, horizontal: 1.23, vertikal: 1.26

Unterschrift des Schützen

Ergebnis: **302.8** (289)
 Serien: 101.5 99.9 101.4
 Zähler: 19 11 0 0 0 0 0 0 0 0
 Innenzehner: 14
 weiteste: 390 (2), 379 (15), 367 (23)
 beste Teiler 46.6 (4.) 87.8 (19.) 95.5 (6.)
 Trefferlage 0.49 mm links, 0.25 mm tief
 Streuwert 1.68, horizontal: 1.70, vertikal: 1.66

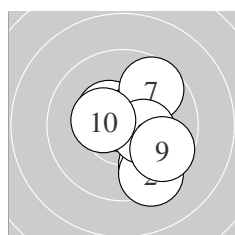
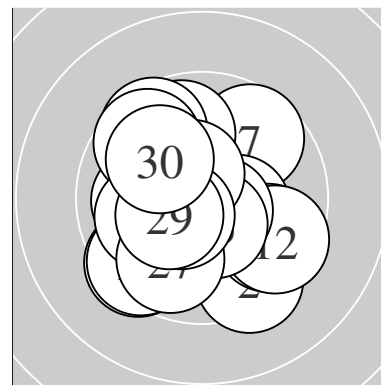

Serie 1:
 9.6 ↘ 9.4 ↘ 10.5 * 10.8 * 10.4 *
 10.6 * 9.7 ↗ 10.4 * 9.7 ↘ 10.4 *
 beste Teiler 46.6 (4.) 95.5 (6.) 116.8 (3.)
 Trefferlage 0.94 mm rechts, 0.28 mm tief
 Streuwert 1.59, horizontal: 1.37, vertikal: 1.79

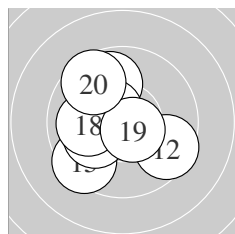

Serie 2:
 9.8 ↗ 9.6 ↘ 10.2 * 10.1 ← 9.4 ↙
 10.1 ← 10.5 * 10.0 ← 10.6 * 9.6 ↘
 beste Teiler 87.8 (19.) 114.7 (17.) 199.1 (13.)
 Trefferlage 1.10 mm links, 0.06 mm tief
 Streuwert 1.74, horizontal: 1.76, vertikal: 1.73

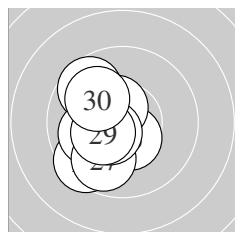

Serie 3:
 10.6 * 9.7 ↘ 9.5 ↙ 10.0 ← 10.5 *
 10.5 * 9.8 ↙ 10.5 * 10.3 * 10.0 ↘
 beste Teiler 99.6 (21.) 111.8 (26.) 114.4 (28.)
 Trefferlage 1.32 mm links, 0.41 mm tief
 Streuwert 1.32, horizontal: 0.93, vertikal: 1.62

Unterschrift des Schützen

Meyton Elektronik

Ergebnis: **309.1** (298)
 Serien: 102.5 104.1 102.5
 Zähler: 28 2 0 0 0 0 0 0 0 0
 Innenzehner: 21
 weiteste: 322 (3), 251 (7), 250 (15)
 beste Teiler 51.1 (4.) 58.6 (13.) 70.5 (16.)
 Trefferlage 0.03 mm links, 0.12 mm tief
 Streuwert 1.25, horizontal: 1.07, vertikal: 1.41

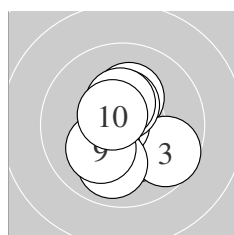
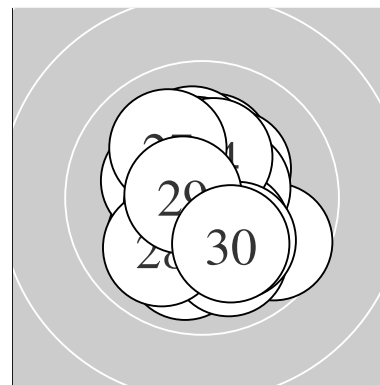

Serie 1:
 10.3 * 10.2 * 9.7 ↘ 10.7 * 10.2 *
 10.4 * 9.9 ↓ 10.4 * 10.1 ✓ 10.6 *
 beste Teiler 51.1 (4.) 92.6 (10.) 130.4 (6.)
 Trefferlage 0.04 mm links, 0.33 mm tief
 Streuwert 1.37, horizontal: 1.18, vertikal: 1.54

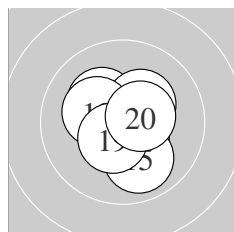

Serie 2:
 10.4 * 10.2 * 10.7 * 10.5 * 10.0 ↓
 10.7 * 10.3 * 10.3 * 10.5 * 10.5 *
 beste Teiler 58.6 (13.) 70.5 (16.) 119.3 (19.)
 Trefferlage 0.04 mm rechts, 0.06 mm tief
 Streuwert 1.11, horizontal: 1.08, vertikal: 1.14

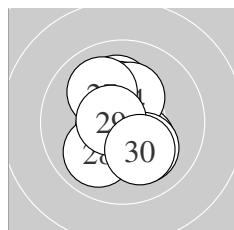

Serie 3:
 10.3 * 10.1 ↑ 10.3 * 10.3 * 10.1 ↓
 10.6 * 10.0 ↘ 10.0 ✓ 10.7 * 10.1 ↓
 beste Teiler 73.8 (29.) 83.6 (26.) 164.2 (24.)
 Trefferlage 0.09 mm links, 0.03 mm hoch
 Streuwert 1.37, horizontal: 1.05, vertikal: 1.63

Unterschrift des Schützen

Meyton Elektronik

Ergebnis: **306.9** (293)
 Serien: 102.5 103.4 101.0
 Zähler: 23 7 0 0 0 0 0 0 0 0
 Innenzehner: 17
 weiteste: 467 (23), 343 (4), 319 (5)
 beste Teiler 52.4 (1.) 54.0 (13.) 61.4 (24.)
 Trefferlage 0.29 mm links, 0.24 mm hoch
 Streuwert 1.45, horizontal: 1.48, vertikal: 1.43

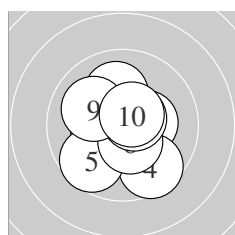
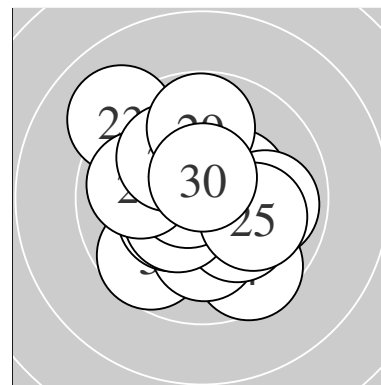

Serie 1:
 10.7 * 10.3 * 10.4 * 9.6 ↘ 9.7 ↙
 10.5 * 10.6 * 10.1 ↑ 10.0 ↖ 10.6 *
 beste Teiler 52.4 (1.) 92.2 (7.) 97.1 (10.)
 Trefferlage 0.07 mm links, 0.16 mm tief
 Streuwert 1.49, horizontal: 1.42, vertikal: 1.56

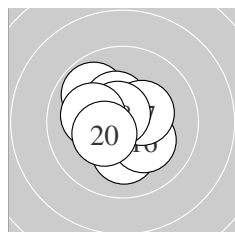

Serie 2:
 10.1 ↓ 9.9 ↖ 10.7 * 10.4 * 10.5 *
 10.2 * 10.4 * 10.7 * 10.1 ← 10.4 *
 beste Teiler 54.0 (13.) 66.7 (18.) 110.4 (15.)
 Trefferlage 0.38 mm links, 0.00 mm
 Streuwert 1.22, horizontal: 1.24, vertikal: 1.19

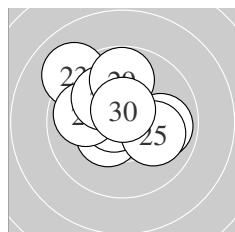

Serie 3:
 9.9 → 10.4 * 9.1 ↖ 10.7 * 10.1 →
 10.4 * 9.9 ← 10.1 ↖ 9.8 ↑ 10.6 *
 beste Teiler 61.4 (24.) 85.0 (30.) 131.0 (26.)
 Trefferlage 0.44 mm links, 0.88 mm hoch
 Streuwert 1.64, horizontal: 1.84, vertikal: 1.42

Unterschrift des Schützen

Meyton Elektronik

Ergebnis: **307.9** (293)
 Serien: 102.2 102.0 103.7
 Zähler: 23 7 0 0 0 0 0 0 0 0
 Innenzehner: 19
 weiteste: 375 (19), 374 (30), 348 (22)
 beste Teiler 18.8 (25.) 40.7 (5.) 42.0 (23.)
 Trefferlage 0.60 mm links, 0.52 mm tief
 Streuwert 1.34, horizontal: 1.26, vertikal: 1.42

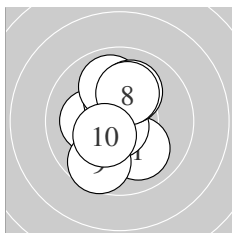
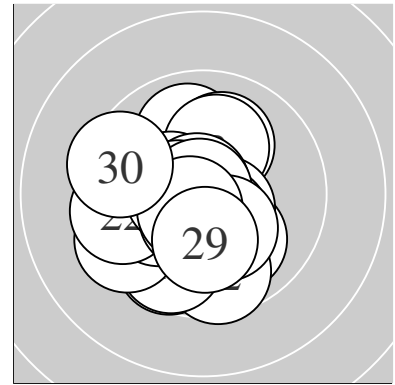

Serie 1:
 10.0 ↘ 10.2 * 10.6 * 10.4 * 10.8 *
 9.9 ↑ 10.1 ↑ 10.1 ↑ 9.7 ↓ 10.4 *
 beste Teiler 40.7 (5.) 84.8 (3.) 145.7 (10.)
 Trefferlage 0.35 mm links, 0.11 mm hoch
 Streuwert 1.47, horizontal: 1.03, vertikal: 1.81

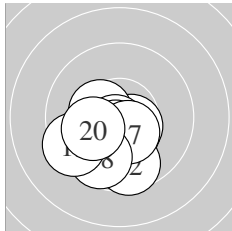

Serie 2:
 10.5 * 9.6 ↓ 10.5 * 10.4 * 10.7 *
 10.5 * 10.5 * 9.7 ↓ 9.5 ← 10.1 ←
 beste Teiler 72.9 (15.) 102.6 (13.) 107.7 (16.)
 Trefferlage 0.57 mm links, 1.28 mm tief
 Streuwert 1.23, horizontal: 1.35, vertikal: 1.10

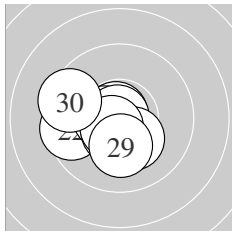

Serie 3:
 10.8 * 9.6 ← 10.8 * 10.5 * 10.9 *
 10.5 * 10.3 * 10.6 * 10.2 * 9.5 ←
 beste Teiler 18.8 (25.) 42.0 (23.) 43.0 (21.)
 Trefferlage 0.88 mm links, 0.40 mm tief
 Streuwert 1.22, horizontal: 1.45, vertikal: 0.93

Unterschrift des Schützen

Ergebnis: **304.5** (288)
 Serien: 100.7 104.6 99.2
 Zähler: 18 12 0 0 0 0 0 0 0 0
 Innenzehner: 13
 weiteste: 429 (27), 338 (20), 313 (26)
 beste Teiler 55.3 (13.) 58.8 (15.) 62.2 (4.)
 Trefferlage 0.79 mm links, 0.66 mm tief
 Streuwert 1.44, horizontal: 1.34, vertikal: 1.53

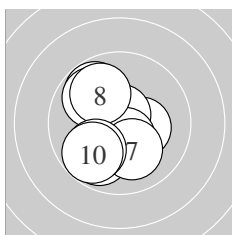
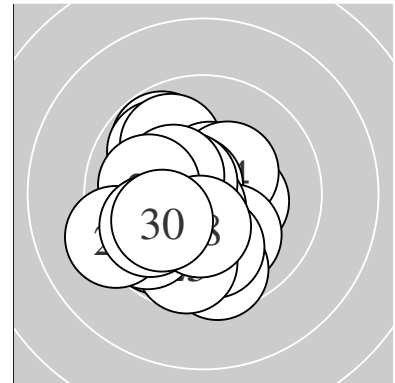

Serie 1:
 9.8 ↘ 10.3 * 9.8 ↙ 10.7 * 9.9 ↘
 10.5 * 10.1 ↓ 9.9 ↘ 9.9 ↙ 9.8 ↙
 beste Teiler 62.2 (4.) 115.7 (6.) 158.2 (2.)
 Trefferlage 0.75 mm links, 0.28 mm tief
 Streuwert 1.64, horizontal: 1.34, vertikal: 1.89

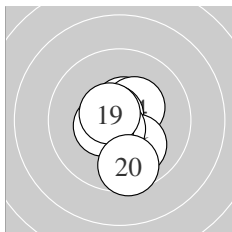

Serie 2:
 10.7 * 10.6 * 10.7 * 10.4 * 10.7 *
 10.1 ↓ 10.7 * 10.5 * 10.6 * 9.6 ↓
 beste Teiler 55.3 (13.) 58.8 (15.) 67.4 (11.)
 Trefferlage 0.06 mm rechts, 0.34 mm tief
 Streuwert 1.10, horizontal: 0.81, vertikal: 1.34

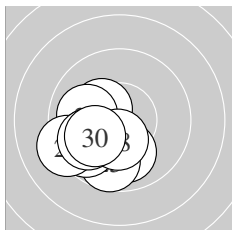

Serie 3:
 10.3 * 10.0 ← 9.9 ↙ 10.0 ↓ 9.7 ↓
 9.7 ↙ 9.2 ↙ 10.4 * 9.9 ↙ 10.1 ↙
 beste Teiler 144.5 (28.) 154.0 (21.) 216.0 (30.)
 Trefferlage 1.68 mm links, 1.35 mm tief
 Streuwert 1.22, horizontal: 1.28, vertikal: 1.16

Unterschrift des Schützen

Ergebnis: **292.0** (277)
 Serien: 97.7 96.0 98.3
 Zähler: 9 19 2 0 0 0 0 0 0 0
 Innenzehner: 6
 weiteste: 574 (4), 508 (5), 484 (17)
 beste Teiler 66.2 (6.) 122.2 (2.) 156.5 (21.)
 Trefferlage 0.48 mm rechts, 1.98 mm hoch
 Streuwert 1.84, horizontal: 1.77, vertikal: 1.91

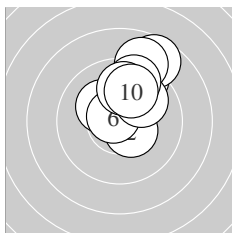
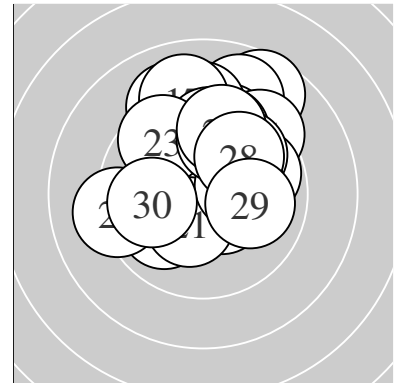

Serie 1:
 9.4 ↗ 10.5 * 10.2 * 8.7 ↗ 8.9 ↗
 10.7 * 9.9 ↗ 9.6 ↑ 9.9 ↑ 9.9 ↑
 beste Teiler 66.2 (6.) 122.2 (2.) 188.6 (3.)
 Trefferlage 0.98 mm rechts, 2.43 mm hoch
 Streuwert 1.57, horizontal: 1.26, vertikal: 1.83

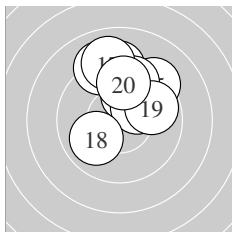

Serie 2:
 9.1 ↖ 9.2 ↑ 10.1 ↑ 10.2 * 9.3 ↗
 9.6 ↑ 9.0 ↑ 10.0 ↙ 9.8 → 9.7 ↑
 beste Teiler 183.2 (14.) 218.5 (13.) 247.2 (18.)
 Trefferlage 0.44 mm rechts, 2.53 mm hoch
 Streuwert 1.80, horizontal: 1.65, vertikal: 1.93

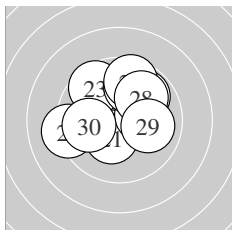

Serie 3:
 10.3 * 9.8 ↗ 9.6 ↖ 10.2 * 9.8 ↑
 9.6 ↑ 9.2 ← 9.9 ↗ 10.0 → 9.9 ←
 beste Teiler 156.5 (21.) 187.7 (24.) 240.8 (29.)
 Trefferlage 0.02 mm rechts, 0.97 mm hoch
 Streuwert 2.03, horizontal: 2.29, vertikal: 1.72

Unterschrift des Schützen

Ergebnis: **277.6** (265)
 Serien: 84.4 97.0 96.2
 Zähler: 9 13 4 3 0 1 0 0 0 0
 Innenzehner: 5
 weiteste: 1376 (2), 992 (1), 913 (26)
 beste Teiler 107.6 (21.) 118.7 (19.) 153.7 (13.)
 Trefferlage 0.01 mm rechts, 1.41 mm hoch
 Streuwert 3.54, horizontal: 4.22, vertikal: 2.69

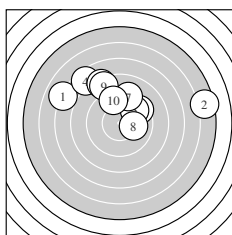
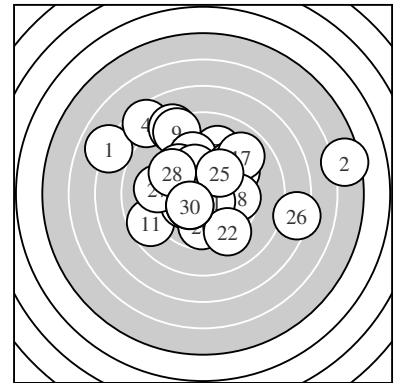

Serie 1:
 7.0 ↘ 5.4 → 9.4 ↗ 7.5 ↖ 9.7 ↗
 8.2 ↖ 9.2 ↑ 10.1 → 8.4 ↖ 9.5 ↑
 beste Teiler 224.3 (8.) 311.2 (5.) 374.3 (10.)
 Trefferlage 0.17 mm rechts, 3.76 mm hoch
 Streuwert 4.54, horizontal: 6.03, vertikal: 2.20

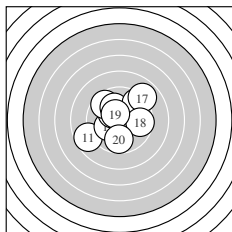

Serie 2:
 8.7 ↙ 10.1 ↙ 10.3 * 9.6 ↖ 10.1 ↖
 9.4 ↗ 8.9 ↗ 9.7 → 10.5 * 9.7 ↓
 beste Teiler 118.7 (19.) 153.7 (13.) 204.5 (12.)
 Trefferlage 0.24 mm links, 0.57 mm hoch
 Streuwert 2.50, horizontal: 2.70, vertikal: 2.27

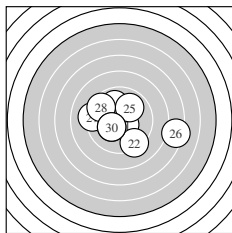

Serie 3:
 10.5 * 9.2 ↘ 10.1 ↖ 9.9 ↑ 9.9 ↗
 7.3 → 9.2 ← 9.5 ↖ 10.3 * 10.3 *
 beste Teiler 107.6 (21.) 165.9 (30.) 167.2 (29.)
 Trefferlage 0.10 mm rechts, 0.10 mm tief
 Streuwert 2.96, horizontal: 3.69, vertikal: 1.96

Unterschrift des Schützen

Ergebnis: **308.9** (296)
 Serien: 102.3 103.5 103.1
 Zähler: 26 4 0 0 0 0 0 0 0 0
 Innenzehner: 20
 weiteste: 318 (4), 306 (1), 280 (17)
 beste Teiler 34.1 (16.) 61.6 (20.) 70.4 (19.)
 Trefferlage 0.72 mm rechts, 0.51 mm tief
 Streuwert 1.12, horizontal: 1.30, vertikal: 0.90

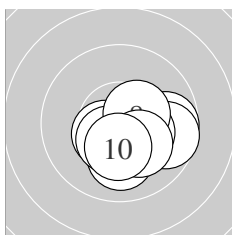
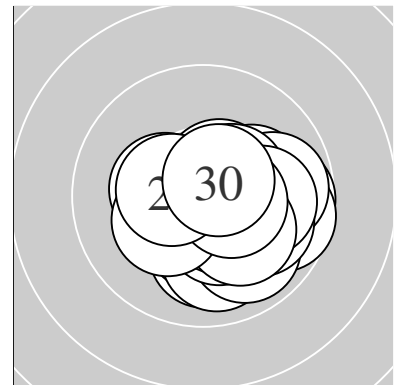

Serie 1:
 9.7 → 10.1 ↓ 10.5 * 9.7 → 10.3 *
 10.7 * 10.4 * 10.4 * 10.2 * 10.3 *
 beste Teiler 75.8 (6.) 120.8 (3.) 128.4 (7.)
 Trefferlage 0.88 mm rechts, 0.85 mm tief
 Streuwert 1.14, horizontal: 1.41, vertikal: 0.79

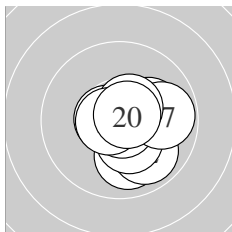

Serie 2:
 10.0 ↓ 9.9 ↘ 10.1 → 10.4 * 10.6 *
 10.8 * 9.8 → 10.5 * 10.7 * 10.7 *
 beste Teiler 34.1 (16.) 61.6 (20.) 70.4 (19.)
 Trefferlage 0.74 mm rechts, 0.39 mm tief
 Streuwert 1.13, horizontal: 1.13, vertikal: 1.13

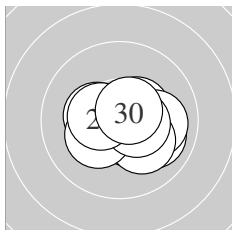

Serie 3:
 10.0 ↘ 10.4 * 10.0 → 10.3 * 10.5 *
 10.1 ↘ 10.3 * 10.5 * 10.4 * 10.6 *
 beste Teiler 88.3 (30.) 113.2 (25.) 116.4 (28.)
 Trefferlage 0.54 mm rechts, 0.28 mm tief
 Streuwert 1.15, horizontal: 1.45, vertikal: 0.73

Unterschrift des Schützen

Ergebnis: **289.2** (276)
 Serien: 93.6 94.7 100.9
 Zähler: 12 14 2 2 0 0 0 0 0 0
 Innenzehner: 10
 weiteste: 777 (3), 762 (7), 608 (28)
 beste Teiler 26.9 (22.) 27.4 (29.) 27.5 (9.)
 Trefferlage 1.56 mm links, 0.26 mm hoch
 Streuwert 2.54, horizontal: 2.78, vertikal: 2.26

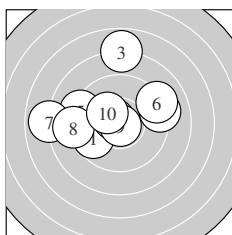
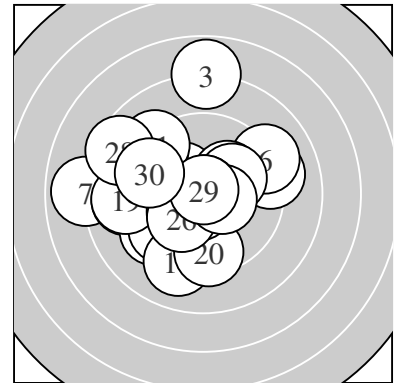

Serie 1:
 9.7 ↙ 10.7 * 7.8 ↑ 9.1 → 9.2 ↖
 9.1 ↗ 7.9 ← 9.0 ← 10.8 * 10.3 *
 beste Teiler 27.5 (9.) 74.8 (2.) 173.2 (10.)
 Trefferlage 1.29 mm links, 1.20 mm hoch
 Streuwert 3.23, horizontal: 3.80, vertikal: 2.55

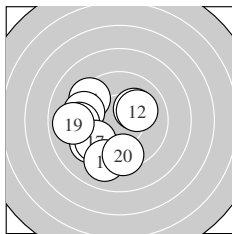

Serie 2:
 10.2 * 10.1 ↗ 9.4 ↙ 9.4 ↘ 9.4 ←
 9.2 ← 9.6 ↙ 9.1 ↓ 8.9 ← 9.4 ↓
 beste Teiler 197.6 (11.) 214.7 (12.) 345.2 (17.)
 Trefferlage 2.00 mm links, 0.80 mm tief
 Streuwert 2.38, horizontal: 2.48, vertikal: 2.27

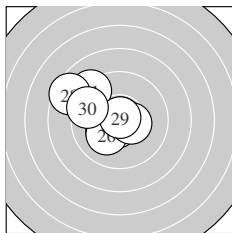

Serie 3:
 9.2 ↘ 10.8 * 10.6 * 10.2 * 10.8 *
 10.1 ↙ 10.4 * 8.5 ↘ 10.8 * 9.5 ↖
 beste Teiler 26.9 (22.) 27.4 (29.) 31.7 (25.)
 Trefferlage 1.39 mm links, 0.40 mm hoch
 Streuwert 1.82, horizontal: 2.03, vertikal: 1.59

Unterschrift des Schützen

Ergebnis: **311.5** (297)
 Serien: 104.6 103.4 103.5
 Zähler: 27 3 0 0 0 0 0 0 0 0
 Innenzehner: 25
 weiteste: 363 (14), 342 (25), 304 (11)
 beste Teiler 19.2 (13.) 22.8 (28.) 40.0 (3.)
 Trefferlage 0.06 mm links, 0.37 mm tief
 Streuwert 1.18, horizontal: 1.34, vertikal: 1.00

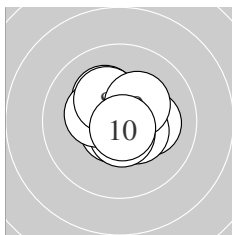
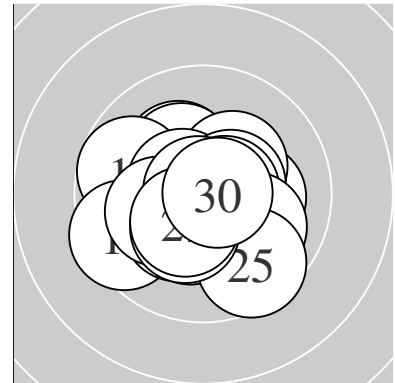

Serie 1:
 10.2 * 10.7 * 10.8 * 10.4 * 10.6 *
 10.2 * 10.3 * 10.3 * 10.3 * 10.8 *
 beste Teiler 40.0 (3.) 49.2 (10.) 74.0 (2.)
 Trefferlage 0.07 mm rechts, 0.23 mm hoch
 Streuwert 1.01, horizontal: 1.10, vertikal: 0.91

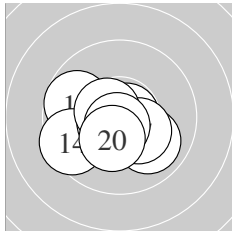

Serie 2:
 9.7 ↖ 10.0 ↘ 10.9 * 9.5 ↙ 10.6 *
 10.8 * 10.3 * 10.6 * 10.7 * 10.3 *
 beste Teiler 19.2 (13.) 45.5 (16.) 60.7 (19.)
 Trefferlage 0.46 mm links, 0.54 mm tief
 Streuwert 1.30, horizontal: 1.62, vertikal: 0.88

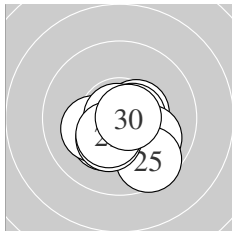

Serie 3:
 10.5 * 10.6 * 10.3 * 10.0 ↘ 9.6 ↘
 10.2 * 10.3 * 10.9 * 10.4 * 10.7 *
 beste Teiler 22.8 (28.) 59.2 (30.) 88.8 (22.)
 Trefferlage 0.20 mm rechts, 0.80 mm tief
 Streuwert 1.15, horizontal: 1.30, vertikal: 0.99

Unterschrift des Schützen

Ergebnis: **286.6** (272)
 Serien: 94.1 94.7 97.8
 Zähler: 12 8 10 0 0 0 0 0 0
 Innenzehner: 9
 weiteste: 745 (13), 689 (26), 633 (6)
 beste Teiler 38.2 (28.) 49.9 (30.) 60.4 (22.)
 Trefferlage 1.48 mm links, 0.27 mm tief
 Streuwert 2.73, horizontal: 3.25, vertikal: 2.08

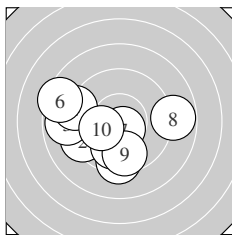
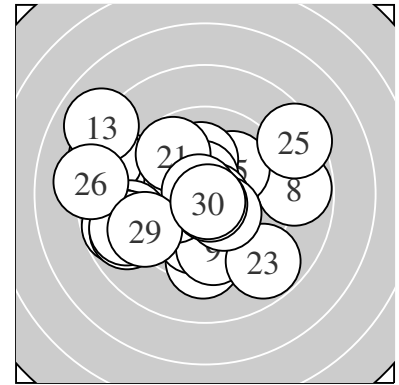

Serie 1:
 9.3 ↓ 9.3 ↙ 8.9 ← 9.1 ↖ 9.9 ↓
 8.4 ↖ 10.6 * 8.8 → 9.6 ↓ 10.2 *
 beste Teiler 84.6 (7.) 195.9 (10.) 264.3 (5.)
 Trefferlage 1.57 mm links, 0.95 mm tief
 Streuwert 2.79, horizontal: 3.41, vertikal: 1.98

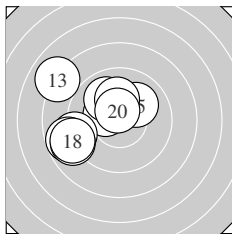

Serie 2:
 10.3 * 9.1 ← 8.0 ↖ 8.7 ↖ 10.1 ↗
 10.0 ↘ 8.9 ↙ 8.9 ↙ 10.1 ↑ 10.6 *
 beste Teiler 98.7 (20.) 153.6 (11.) 208.6 (19.)
 Trefferlage 2.69 mm links, 0.36 mm hoch
 Streuwert 2.44, horizontal: 2.67, vertikal: 2.18

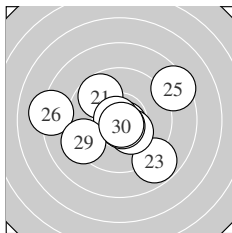

Serie 3:
 9.7 ↘ 10.7 * 8.8 ↘ 10.3 * 8.5 ↗
 8.2 ← 10.7 * 10.8 * 9.3 ↙ 10.8 *
 beste Teiler 38.2 (28.) 49.9 (30.) 60.4 (22.)
 Trefferlage 0.18 mm links, 0.23 mm tief
 Streuwert 2.84, horizontal: 3.44, vertikal: 2.07

Unterschrift des Schützen

Ergebnis: **300.7** (289)
 Serien: 96.3 103.8 100.6
 Zähler: 22 6 1 1 0 0 0 0 0 0
 Innenzehner: 16
 weiteste: 855 (5), 512 (2), 487 (26)
 beste Teiler 22.0 (13.) 43.7 (10.) 50.3 (15.)
 Trefferlage 0.47 mm rechts, 0.98 mm tief
 Streuwert 1.94, horizontal: 1.67, vertikal: 2.17

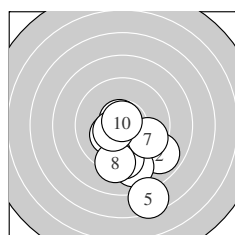
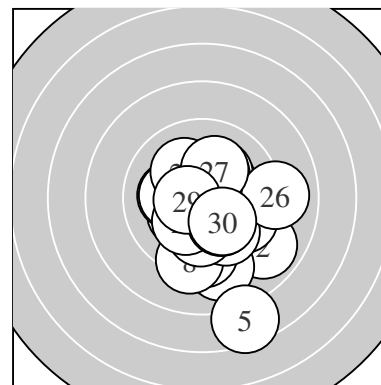

Serie 1:
 10.3 * 8.9 ↘ 9.1 ↓ 10.7 * 7.5 ↓
 9.5 ↓ 9.7 ↘ 9.3 ↓ 10.5 * 10.8 *
 beste Teiler 43.7 (10.) 68.6 (4.) 122.4 (9.)
 Trefferlage 0.73 mm rechts, 2.56 mm tief
 Streuwert 2.32, horizontal: 1.90, vertikal: 2.68

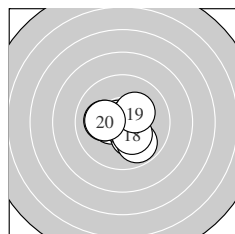

Serie 2:
 10.4 * 10.2 * 10.9 * 9.9 ↘ 10.8 *
 10.7 * 10.1 ← 10.3 * 10.3 * 10.2 *
 beste Teiler 22.0 (13.) 50.3 (15.) 66.6 (16.)
 Trefferlage 0.02 mm links, 0.36 mm tief
 Streuwert 1.20, horizontal: 1.35, vertikal: 1.02

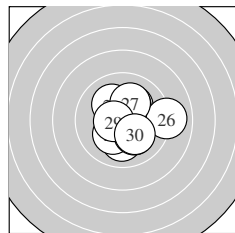

Serie 3:
 10.0 ↓ 10.1 ↖ 10.2 * 10.2 * 10.2 *
 9.0 → 10.1 ↗ 10.1 ↘ 10.6 * 10.1 ↘
 beste Teiler 98.8 (29.) 180.2 (25.) 188.0 (24.)
 Trefferlage 0.70 mm rechts, 0.02 mm tief
 Streuwert 1.71, horizontal: 1.78, vertikal: 1.64

Unterschrift des Schützen

Meyton Elektronik

Ergebnis: **302.5** (289)
 Serien: 99.8 102.3 100.4
 Zähler: 20 9 1 0 0 0 0 0 0 0
 Innenzehner: 15
 weiteste: 669 (1), 371 (7), 363 (21)
 beste Teiler 59.4 (19.) 84.0 (9.) 105.9 (5.)
 Trefferlage 0.34 mm links, 0.46 mm hoch
 Streuwert 1.73, horizontal: 1.41, vertikal: 2.00

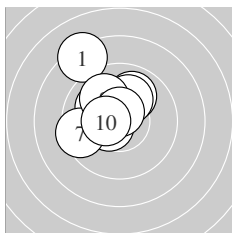
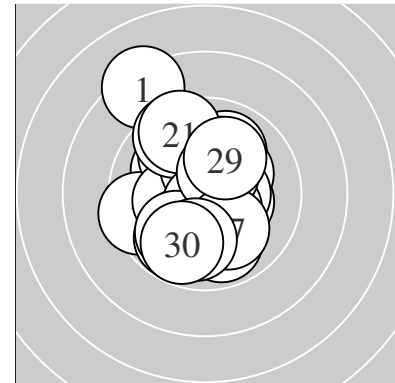

Serie 1:
 8.3 ↘ 10.3 * 9.9 ↗ 10.1 ↗ 10.5 *
 10.1 ↘ 9.5 ← 10.0 ↘ 10.6 * 10.5 *
 beste Teiler 84.0 (9.) 105.9 (5.) 124.0 (10.)
 Trefferlage 1.11 mm links, 1.41 mm hoch
 Streuwert 1.74, horizontal: 1.55, vertikal: 1.90

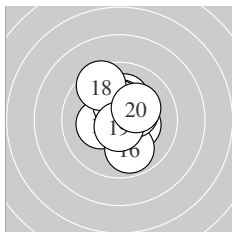

Serie 2:
 10.2 * 10.4 * 10.3 * 10.3 * 10.4 *
 9.9 ↓ 10.4 * 9.5 ↘ 10.7 * 10.2 *
 beste Teiler 59.4 (19.) 143.2 (15.) 143.5 (17.)
 Trefferlage 0.19 mm rechts, 0.57 mm hoch
 Streuwert 1.41, horizontal: 1.18, vertikal: 1.61

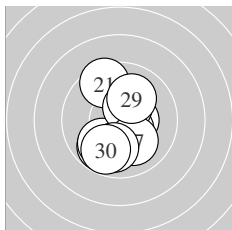

Serie 3:
 9.5 ↘ 9.8 ↙ 10.4 * 10.5 * 9.9 ↙
 10.4 * 10.1 ↘ 9.9 ↓ 10.1 ↗ 9.8 ↙
 beste Teiler 120.2 (24.) 133.0 (23.) 136.0 (26.)
 Trefferlage 0.11 mm links, 0.58 mm tief
 Streuwert 1.75, horizontal: 1.27, vertikal: 2.12

Unterschrift des Schützen

Ergebnis: **315.6** (299)
 Serien: 105.7 105.9 104.0
 Zähler: 29 1 0 0 0 0 0 0 0 0
 Innenzehner: 29
 weiteste: 282 (29), 191 (10), 191 (18)
 beste Teiler 25.9 (16.) 36.8 (15.) 47.6 (27.)
 Trefferlage 0.15 mm rechts, 0.30 mm hoch
 Streuwert 0.86, horizontal: 0.94, vertikal: 0.77

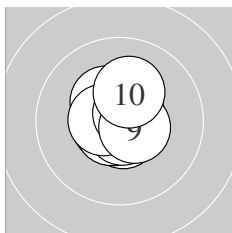
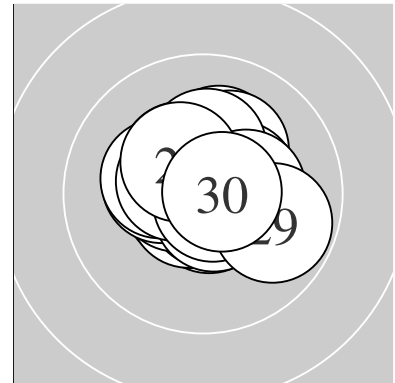

Serie 1:
 10.6 * 10.6 * 10.7 * 10.4 * 10.7 *
 10.7 * 10.6 * 10.7 * 10.5 * 10.2 *
 beste Teiler 53.7 (6.) 66.6 (3.) 74.9 (5.)
 Trefferlage 0.10 mm links, 0.06 mm hoch
 Streuwert 0.78, horizontal: 0.69, vertikal: 0.85

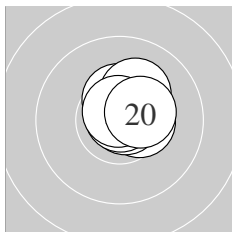

Serie 2:
 10.6 * 10.8 * 10.5 * 10.6 * 10.8 *
 10.9 * 10.4 * 10.2 * 10.7 * 10.4 *
 beste Teiler 25.9 (16.) 36.8 (15.) 48.7 (12.)
 Trefferlage 0.48 mm rechts, 0.60 mm hoch
 Streuwert 0.54, horizontal: 0.52, vertikal: 0.55

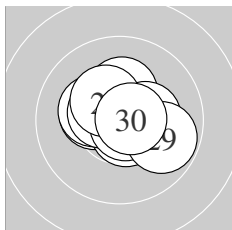

Serie 3:
 10.3 * 10.3 * 10.6 * 10.3 * 10.5 *
 10.3 * 10.8 * 10.4 * 9.8 ↘ 10.7 *
 beste Teiler 47.6 (27.) 71.4 (30.) 78.0 (23.)
 Trefferlage 0.07 mm rechts, 0.25 mm hoch
 Streuwert 1.13, horizontal: 1.37, vertikal: 0.83

Unterschrift des Schützen

Ergebnis: **312.7** (299)
 Serien: 103.8 104.5 104.4
 Zähler: 29 1 0 0 0 0 0 0 0 0
 Innenzehner: 23
 weiteste: 271 (4), 233 (16), 224 (23)
 beste Teiler 32.3 (19.) 46.0 (12.) 56.2 (11.)
 Trefferlage 0.00 mm , 0.04 mm tief
 Streuwert 1.06, horizontal: 1.01, vertikal: 1.11

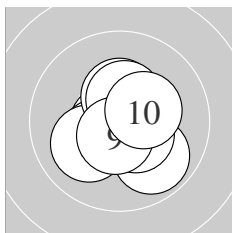
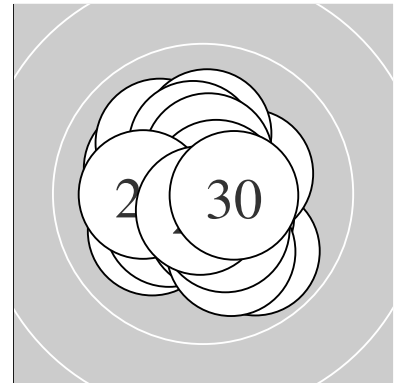

Serie 1:
 10.6 * 10.7 * 10.3 * 9.9 ↘ 10.1 ↗
 10.5 * 10.4 * 10.4 * 10.6 * 10.3 *
 beste Teiler 64.9 (2.) 85.7 (1.) 88.8 (9.)
 Trefferlage 0.02 mm rechts, 0.34 mm tief
 Streuwert 1.13, horizontal: 1.13, vertikal: 1.13

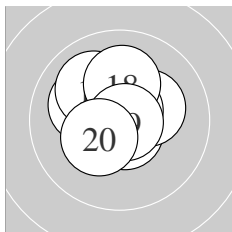

Serie 2:
 10.7 * 10.8 * 10.7 * 10.3 * 10.1 ↗
 10.0 ↘ 10.7 * 10.1 ↑ 10.8 * 10.3 *
 beste Teiler 32.3 (19.) 46.0 (12.) 56.2 (11.)
 Trefferlage 0.19 mm links, 0.41 mm hoch
 Streuwert 1.04, horizontal: 1.05, vertikal: 1.02

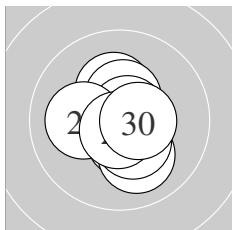

Serie 3:
 10.5 * 10.7 * 10.1 ↘ 10.3 * 10.4 *
 10.4 * 10.7 * 10.1 ← 10.7 * 10.5 *
 beste Teiler 57.2 (27.) 58.8 (29.) 74.0 (22.)
 Trefferlage 0.18 mm rechts, 0.21 mm tief
 Streuwert 1.03, horizontal: 0.92, vertikal: 1.13

Unterschrift des Schützen

Ergebnis: **314.3** (299)
 Serien: 106.2 103.0 105.1
 Zähler: 29 1 0 0 0 0 0 0 0 0
 Innenzehner: 26
 weiteste: 256 (17), 213 (13), 212 (30)
 beste Teiler 30.2 (6.) 36.8 (10.) 36.8 (23.)
 Trefferlage 0.10 mm links, 0.11 mm tief
 Streuwert 0.97, horizontal: 1.05, vertikal: 0.88

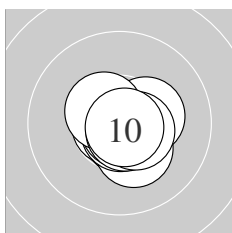
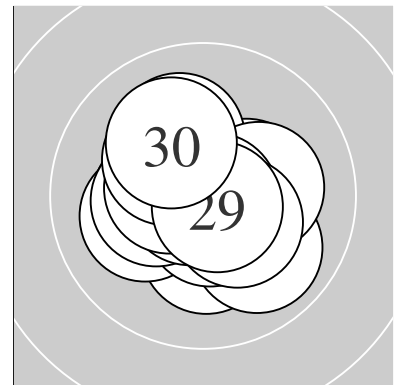

Serie 1:
 10.7 * 10.3 * 10.8 * 10.7 * 10.3 *
 10.8 * 10.5 * 10.7 * 10.6 * 10.8 *
 beste Teiler 30.2 (6.) 36.8 (10.) 50.0 (3.)
 Trefferlage 0.26 mm rechts, 0.31 mm tief
 Streuwert 0.63, horizontal: 0.68, vertikal: 0.58

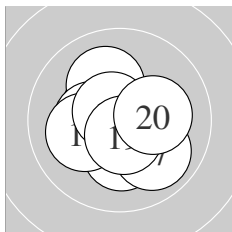

Serie 2:
 10.4 * 10.5 * 10.1 ↗ 10.3 * 10.2 *
 10.1 ← 9.9 ↘ 10.7 * 10.6 * 10.2 *
 beste Teiler 68.6 (18.) 89.2 (19.) 123.9 (12.)
 Trefferlage 0.05 mm links, 0.26 mm tief
 Streuwert 1.27, horizontal: 1.38, vertikal: 1.16

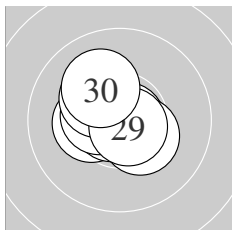

Serie 3:
 10.5 * 10.3 * 10.8 * 10.4 * 10.7 *
 10.8 * 10.5 * 10.3 * 10.7 * 10.1 ↗
 beste Teiler 36.8 (23.) 45.8 (26.) 61.4 (29.)
 Trefferlage 0.52 mm links, 0.23 mm hoch
 Streuwert 0.85, horizontal: 0.91, vertikal: 0.79

Unterschrift des Schützen

Ergebnis: **311.7** (297)
 Serien: 104.7 103.6 103.4
 Zähler: 27 3 0 0 0 0 0 0 0 0
 Innenzehner: 25
 weiteste: 309 (22), 292 (27), 282 (18)
 beste Teiler 39.5 (13.) 42.0 (17.) 43.0 (25.)
 Trefferlage 0.76 mm rechts, 0.06 mm tief
 Streuwert 1.00, horizontal: 0.92, vertikal: 1.07

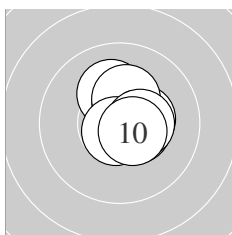
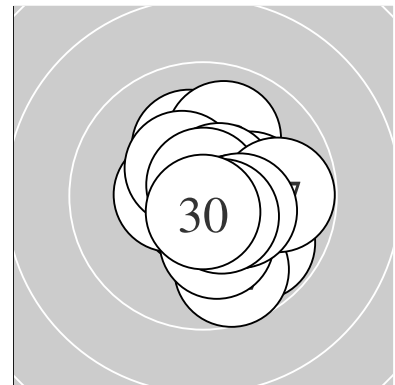

Serie 1:
 10.7 * 10.2 * 10.5 * 10.4 * 10.4 *
 10.3 * 10.5 * 10.7 * 10.4 * 10.6 *
 beste Teiler 57.2 (8.) 74.6 (1.) 99.6 (10.)
 Trefferlage 0.65 mm rechts, 0.35 mm hoch
 Streuwert 0.78, horizontal: 0.65, vertikal: 0.90

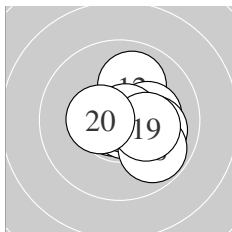

Serie 2:
 10.6 * 10.0 ↗ 10.8 * 10.8 * 10.2 *
 10.0 → 10.8 * 9.8 ↘ 10.2 * 10.4 *
 beste Teiler 39.5 (13.) 42.0 (17.) 47.8 (14.)
 Trefferlage 0.85 mm rechts, 0.02 mm tief
 Streuwert 1.08, horizontal: 1.14, vertikal: 1.02

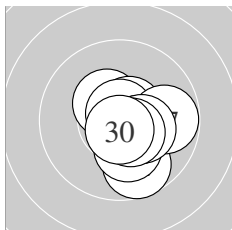

Serie 3:
 10.4 * 9.7 ↘ 10.6 * 10.2 * 10.8 *
 10.4 * 9.8 → 10.3 * 10.5 * 10.7 *
 beste Teiler 43.0 (25.) 63.0 (30.) 87.6 (23.)
 Trefferlage 0.77 mm rechts, 0.51 mm tief
 Streuwert 1.09, horizontal: 1.01, vertikal: 1.17

Unterschrift des Schützen

Ergebnis: **293.7** (280)
 Serien: 96.2 99.4 98.1
 Zähler: 13 14 3 0 0 0 0 0 0 0
 Innenzehner: 8
 weiteste: 581 (24), 539 (6), 517 (19)
 beste Teiler 45.3 (18.) 60.1 (21.) 81.5 (11.)
 Trefferlage 0.71 mm links, 1.54 mm hoch
 Streuwert 2.03, horizontal: 2.17, vertikal: 1.87

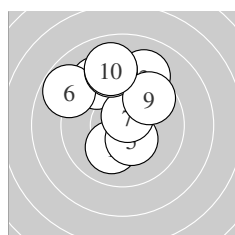
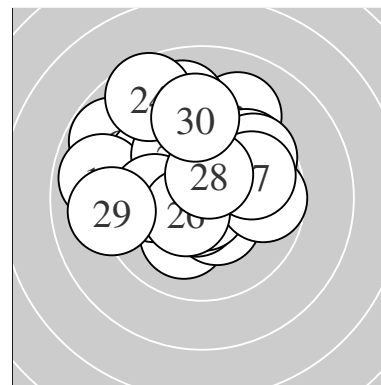

Serie 1:
 10.1 ↘ 10.1 ↗ 9.1 ↗ 9.3 ↘ 10.4 *
 8.8 ↖ 10.6 * 9.1 ↑ 9.7 ↗ 9.0 ↑
 beste Teiler 88.5 (7.) 140.3 (5.) 209.7 (1.)
 Trefferlage 0.37 mm links, 2.20 mm hoch
 Streuwert 2.18, horizontal: 2.02, vertikal: 2.33

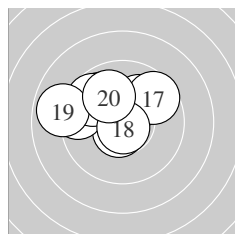

Serie 2:
 10.6 * 9.4 ← 10.4 * 9.9 ↘ 10.1 ↗
 9.7 ↘ 9.6 ↗ 10.8 * 8.9 ← 10.0 ↘
 beste Teiler 45.3 (18.) 81.5 (11.) 135.7 (13.)
 Trefferlage 1.08 mm links, 1.18 mm hoch
 Streuwert 1.80, horizontal: 2.32, vertikal: 1.05

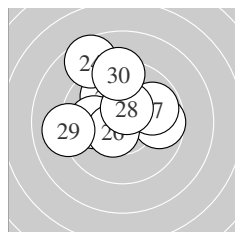

Serie 3:
 10.7 * 9.9 ↘ 10.0 ← 8.6 ↘ 9.7 →
 10.5 * 9.8 ↗ 10.5 * 9.1 ← 9.3 ↑
 beste Teiler 60.1 (21.) 109.7 (26.) 124.3 (28.)
 Trefferlage 0.68 mm links, 1.25 mm hoch
 Streuwert 2.17, horizontal: 2.33, vertikal: 2.00

Unterschrift des Schützen

Ergebnis: **306.5** (294)
 Serien: 99.6 105.0 101.9
 Zähler: 24 6 0 0 0 0 0 0 0 0
 Innenzehner: 18
 weiteste: 459 (9), 361 (1), 280 (25)
 beste Teiler 56.0 (11.) 73.4 (12.) 73.6 (20.)
 Trefferlage 0.40 mm links, 0.04 mm hoch
 Streuwert 1.45, horizontal: 1.45, vertikal: 1.45

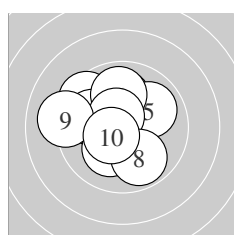
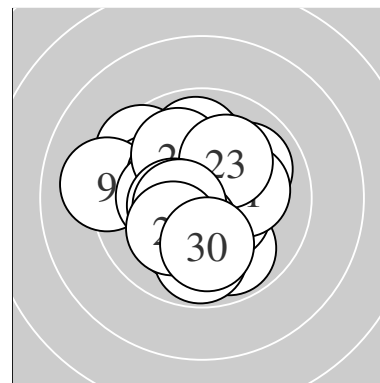

Serie 1:
 9.5 ↘ 9.9 ← 10.0 ↑ 10.2 * 10.0 ↗
 9.9 ↑ 10.6 * 9.9 ↘ 9.1 ← 10.5 *
 beste Teiler 100.8 (7.) 112.2 (10.) 197.2 (4.)
 Trefferlage 0.91 mm links, 0.59 mm hoch
 Streuwert 1.84, horizontal: 1.96, vertikal: 1.70

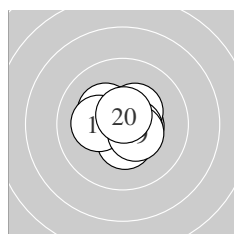

Serie 2:
 10.7 * 10.7 * 10.5 * 10.4 * 10.4 *
 10.6 * 10.3 * 10.2 * 10.5 * 10.7 *
 beste Teiler 56.0 (11.) 73.4 (12.) 73.6 (20.)
 Trefferlage 0.04 mm rechts, 0.09 mm hoch
 Streuwert 0.92, horizontal: 1.04, vertikal: 0.79

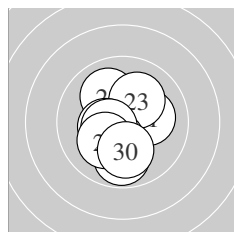

Serie 3:
 10.2 * 10.0 ↘ 10.1 ↗ 10.3 * 9.8 ↓
 10.4 * 10.4 * 10.5 * 10.1 ↙ 10.1 ↓
 beste Teiler 115.1 (28.) 139.7 (27.) 150.8 (26.)
 Trefferlage 0.34 mm links, 0.55 mm tief
 Streuwert 1.39, horizontal: 1.16, vertikal: 1.59

Unterschrift des Schützen

Ergebnis: **308.3** (297)
 Serien: 101.3 104.9 102.1
 Zähler: 27 3 0 0 0 0 0 0 0 0
 Innenzehner: 22
 weiteste: 366 (30), 364 (4), 331 (7)
 beste Teiler 25.0 (13.) 66.8 (20.) 99.3 (2.)
 Trefferlage 0.55 mm rechts, 0.19 mm tief
 Streuwert 1.26, horizontal: 1.23, vertikal: 1.30

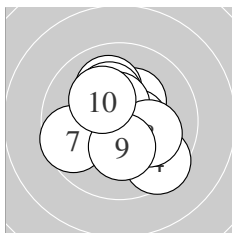
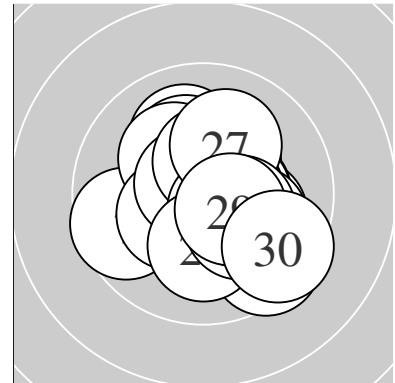

Serie 1:
 10.3 * 10.6 * 10.0 ↗ 9.5 ↘ 10.2 *
 10.5 * 9.6 ← 10.1 → 10.3 * 10.2 *
 beste Teiler 99.3 (2.) 108.2 (6.) 158.6 (1.)
 Trefferlage 0.05 mm rechts, 0.12 mm hoch
 Streuwert 1.64, horizontal: 1.63, vertikal: 1.64

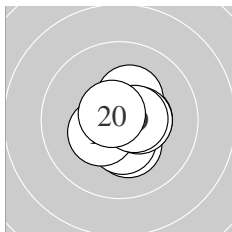

Serie 2:
 10.5 * 10.4 * 10.9 * 10.3 * 10.4 *
 10.3 * 10.4 * 10.4 * 10.6 * 10.7 *
 beste Teiler 25.0 (13.) 66.8 (20.) 99.3 (19.)
 Trefferlage 0.41 mm rechts, 0.17 mm tief
 Streuwert 0.87, horizontal: 0.84, vertikal: 0.89

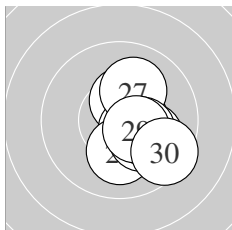

Serie 3:
 10.5 * 10.4 * 10.5 * 10.1 ↘ 10.1 ↓
 10.2 * 10.1 ↗ 10.3 * 10.4 * 9.5 ↘
 beste Teiler 104.4 (23.) 105.2 (21.) 127.1 (29.)
 Trefferlage 1.20 mm rechts, 0.52 mm tief
 Streuwert 1.11, horizontal: 0.86, vertikal: 1.31

 Unterschrift des Schützen

Ergebnis: **306.8** (293)
 Serien: 101.3 102.2 103.3
 Zähler: 23 7 0 0 0 0 0 0 0 0
 Innenzehner: 19
 weiteste: 380 (19), 339 (3), 338 (30)
 beste Teiler 29.1 (24.) 57.6 (17.) 66.7 (9.)
 Trefferlage 0.21 mm links, 0.36 mm tief
 Streuwert 1.41, horizontal: 1.47, vertikal: 1.36

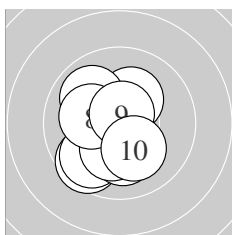
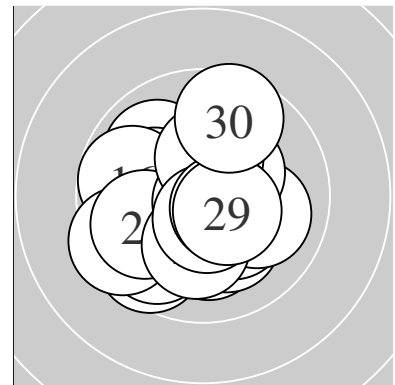

Serie 1:
 10.2 * 9.9 ↖ 9.6 ↙ 10.4 * 9.8 ↘
 10.1 ↓ 10.2 * 10.2 * 10.7 * 10.2 *
 beste Teiler 66.7 (9.) 129.9 (4.) 180.6 (7.)
 Trefferlage 0.76 mm links, 0.60 mm tief
 Streuwert 1.45, horizontal: 1.23, vertikal: 1.65

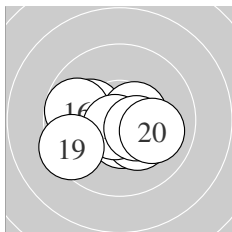

Serie 2:
 10.5 * 10.5 * 10.1 ↖ 10.5 * 10.3 *
 9.8 ↖ 10.7 * 10.4 * 9.4 ↙ 10.0 →
 beste Teiler 57.6 (17.) 106.0 (12.) 109.1 (11.)
 Trefferlage 0.18 mm links, 0.47 mm tief
 Streuwert 1.48, horizontal: 1.92, vertikal: 0.82

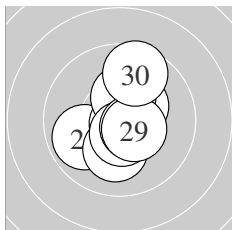

Serie 3:
 9.9 ↙ 10.1 ↓ 10.5 * 10.8 * 10.4 *
 10.3 * 10.6 * 10.6 * 10.5 * 9.6 ↑
 beste Teiler 29.1 (24.) 95.3 (27.) 100.3 (28.)
 Trefferlage 0.28 mm rechts, 0.03 mm tief
 Streuwert 1.32, horizontal: 1.07, vertikal: 1.53

Unterschrift des Schützen

Meyton Elektronik

Ergebnis: **312.4** (299)
 Serien: 104.5 103.7 104.2
 Zähler: 29 1 0 0 0 0 0 0 0 0
 Innenzehner: 24
 weiteste: 292 (18), 243 (4), 236 (12)
 beste Teiler 38.0 (3.) 43.0 (6.) 46.0 (24.)
 Trefferlage 0.35 mm rechts, 0.01 mm hoch
 Streuwert 1.07, horizontal: 0.83, vertikal: 1.26

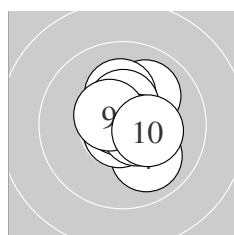
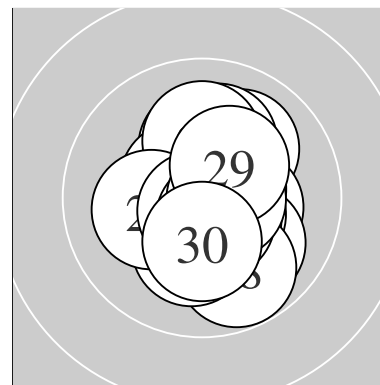

Serie 1:
 10.0 ↗ 10.2 * 10.8 * 10.0 ↘ 10.8 *
 10.8 * 10.5 * 10.6 * 10.5 * 10.3 *
 beste Teiler 38.0 (3.) 43.0 (6.) 47.4 (5.)
 Trefferlage 0.41 mm rechts, 0.26 mm hoch
 Streuwert 1.03, horizontal: 0.85, vertikal: 1.19

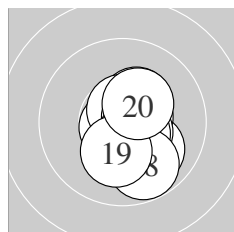

Serie 2:
 10.4 * 10.0 ↘ 10.7 * 10.6 * 10.6 *
 10.5 * 10.5 * 9.8 ↘ 10.2 * 10.4 *
 beste Teiler 58.5 (13.) 76.0 (14.) 97.7 (15.)
 Trefferlage 0.64 mm rechts, 0.43 mm tief
 Streuwert 1.06, horizontal: 0.71, vertikal: 1.32

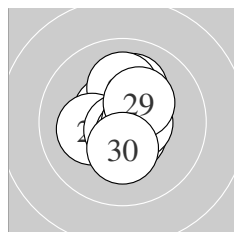

Serie 3:
 10.5 * 10.1 ↑ 10.1 ↑ 10.8 * 10.2 *
 10.7 * 10.6 * 10.6 * 10.3 * 10.3 *
 beste Teiler 46.0 (24.) 52.5 (26.) 91.1 (28.)
 Trefferlage 0.01 mm rechts, 0.22 mm hoch
 Streuwert 1.08, horizontal: 0.87, vertikal: 1.26

Unterschrift des Schützen

Meyton Elektronik

Ergebnis: **310.9** (299)
 Serien: 104.7 103.4 102.8
 Zähler: 29 1 0 0 0 0 0 0 0 0
 Innenzehner: 25
 weiteste: 400 (21), 239 (24), 230 (14)
 beste Teiler 15.2 (9.) 41.0 (15.) 54.1 (17.)
 Trefferlage 0.28 mm rechts, 0.00 mm
 Streuwert 1.17, horizontal: 0.99, vertikal: 1.32

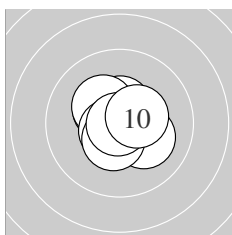
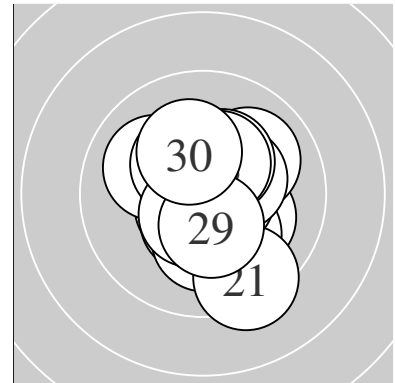

Serie 1:
 10.4 * 10.6 * 10.5 * 10.3 * 10.3 *
 10.6 * 10.2 * 10.5 * 10.9 * 10.4 *
 beste Teiler 15.2 (9.) 85.4 (6.) 98.2 (2.)
 Trefferlage 0.10 mm rechts, 0.11 mm hoch
 Streuwert 0.99, horizontal: 1.05, vertikal: 0.94

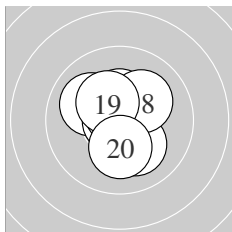

Serie 2:
 10.4 * 10.5 * 10.3 * 10.0 ↘ 10.8 *
 10.1 ↘ 10.7 * 10.1 ↗ 10.3 * 10.2 *
 beste Teiler 41.0 (15.) 54.1 (17.) 120.2 (12.)
 Trefferlage 0.06 mm rechts, 0.05 mm tief
 Streuwert 1.20, horizontal: 1.03, vertikal: 1.35

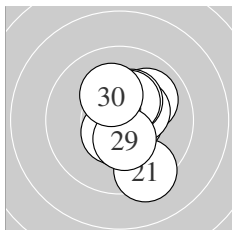

Serie 3:
 9.4 ↘ 10.6 * 10.5 * 10.0 ↗ 10.4 *
 10.6 * 10.3 * 10.4 * 10.4 * 10.2 *
 beste Teiler 82.8 (22.) 100.3 (26.) 114.2 (23.)
 Trefferlage 0.67 mm rechts, 0.04 mm tief
 Streuwert 1.34, horizontal: 0.87, vertikal: 1.69

Unterschrift des Schützen

Meyton Elektronik

Ergebnis: **310.7** (295)
 Serien: 102.9 104.8 103.0
 Zähler: 25 5 0 0 0 0 0 0 0 0
 Innenzehner: 22
 weiteste: 422 (26), 284 (2), 275 (24)
 beste Teiler 12.7 (13.) 20.2 (12.) 38.3 (28.)
 Trefferlage 0.04 mm links, 0.02 mm tief
 Streuwert 1.30, horizontal: 1.53, vertikal: 1.00

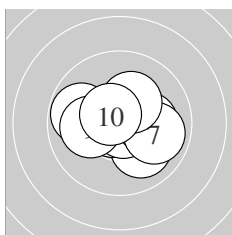
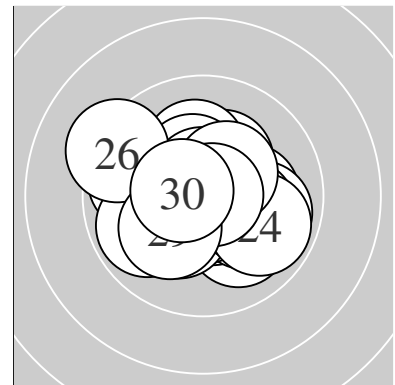

Serie 1:
 10.5 * 9.8 ← 10.0 ↘ 10.7 * 10.8 *
 10.2 * 9.9 → 10.3 * 10.1 ← 10.6 *
 beste Teiler 41.1 (5.) 54.5 (4.) 91.9 (10.)
 Trefferlage 0.21 mm rechts, 0.01 mm hoch
 Streuwert 1.37, horizontal: 1.72, vertikal: 0.90

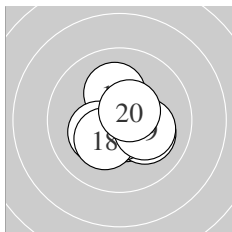

Serie 2:
 10.6 * 10.9 * 10.9 * 10.2 * 10.1 ↘
 10.7 * 10.3 * 10.3 * 10.2 * 10.6 *
 beste Teiler 12.7 (13.) 20.2 (12.) 71.0 (16.)
 Trefferlage 0.19 mm rechts, 0.29 mm tief
 Streuwert 1.03, horizontal: 1.09, vertikal: 0.97

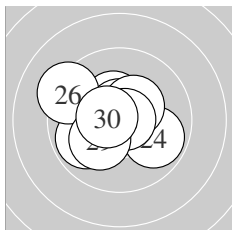

Serie 3:
 10.4 * 10.8 * 9.9 ← 9.9 ↘ 10.7 *
 9.3 ↖ 10.4 * 10.8 * 10.2 * 10.6 *
 beste Teiler 38.3 (28.) 49.2 (22.) 75.1 (25.)
 Trefferlage 0.52 mm links, 0.19 mm hoch
 Streuwert 1.48, horizontal: 1.75, vertikal: 1.16

Unterschrift des Schützen

Ergebnis: **290.4** (278)
 Serien: 99.2 94.3 96.9
 Zähler: 13 14 1 2 0 0 0 0 0 0
 Innenzehner: 9
 weiteste: 847 (18), 776 (20), 610 (24)
 beste Teiler 109.0 (7.) 141.5 (5.) 146.8 (28.)
 Trefferlage 0.40 mm links, 0.49 mm hoch
 Streuwert 2.57, horizontal: 2.92, vertikal: 2.16

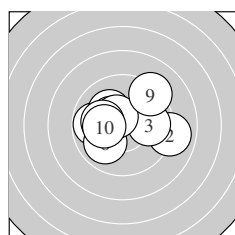
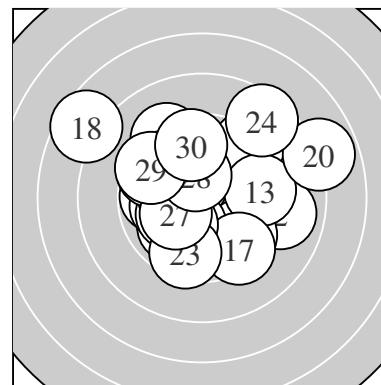

Serie 1:
 9.8 ← 9.0 → 9.9 → 10.2 * 10.4 *
 9.9 ↙ 10.5 * 10.1 ← 9.2 ↗ 10.2 *
 beste Teiler 109.0 (7.) 141.5 (5.) 191.3 (10.)
 Trefferlage 0.13 mm links, 0.40 mm hoch
 Streuwert 2.10, horizontal: 2.64, vertikal: 1.35

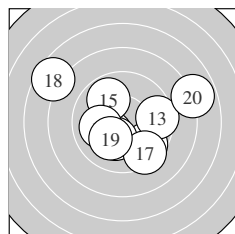

Serie 2:
 9.6 ↘ 10.3 * 9.5 → 10.2 * 9.8 ↖
 10.0 ← 9.4 ↘ 7.6 ↖ 10.1 ↙ 7.8 →
 beste Teiler 167.6 (12.) 187.3 (14.) 210.0 (19.)
 Trefferlage 0.14 mm rechts, 0.04 mm tief
 Streuwert 3.30, horizontal: 3.95, vertikal: 2.48

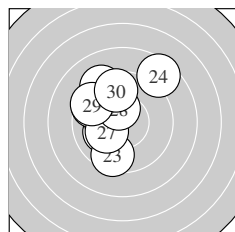

Serie 3:
 10.1 ↙ 9.2 ↖ 9.5 ↓ 8.5 ↗ 10.3 *
 9.6 ↖ 10.2 * 10.4 * 9.5 ↖ 9.6 ↑
 beste Teiler 146.8 (28.) 175.2 (25.) 190.5 (27.)
 Trefferlage 1.21 mm links, 1.14 mm hoch
 Streuwert 2.25, horizontal: 1.96, vertikal: 2.50

Unterschrift des Schützen

Meyton Elektronik

Ergebnis: **309.9** (296)
 Serien: 102.6 103.1 104.2
 Zähler: 26 4 0 0 0 0 0 0 0 0
 Innenzehner: 21
 weiteste: 369 (4), 278 (13), 270 (17)
 beste Teiler 33.5 (23.) 46.1 (30.) 52.0 (3.)
 Trefferlage 0.27 mm rechts, 0.04 mm tief
 Streuwert 1.24, horizontal: 1.36, vertikal: 1.11

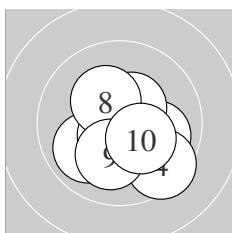
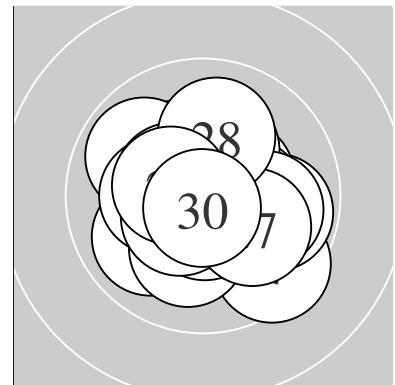

Serie 1:
 10.0 → 10.7 * 10.7 * 9.5 ↘ 9.9 ↙
 10.5 * 10.6 * 10.3 * 10.1 ↓ 10.3 *
 beste Teiler 52.0 (3.) 61.4 (2.) 88.3 (7.)
 Trefferlage 0.37 mm rechts, 0.56 mm tief
 Streuwert 1.38, horizontal: 1.45, vertikal: 1.31

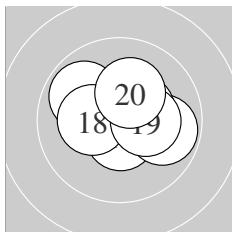

Serie 2:
 10.6 * 10.6 * 9.8 → 10.6 * 10.4 *
 10.4 * 9.9 ↘ 10.3 * 10.3 * 10.2 *
 beste Teiler 79.0 (11.) 81.9 (14.) 97.2 (12.)
 Trefferlage 0.15 mm rechts, 0.44 mm hoch
 Streuwert 1.25, horizontal: 1.54, vertikal: 0.86

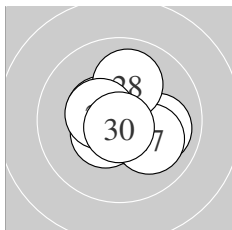

Serie 3:
 10.7 * 10.5 * 10.8 * 10.0 → 10.4 *
 10.5 * 10.1 ↘ 10.0 ↑ 10.4 * 10.8 *
 beste Teiler 33.5 (23.) 46.1 (30.) 75.4 (21.)
 Trefferlage 0.30 mm rechts, 0.03 mm tief
 Streuwert 1.11, horizontal: 1.21, vertikal: 0.99

Unterschrift des Schützen

Ergebnis: **305.4** (290)
 Serien: 102.4 101.9 101.1
 Zähler: 20 10 0 0 0 0 0 0 0 0
 Innenzehner: 16
 weiteste: 398 (27), 366 (13), 358 (22)
 beste Teiler 51.4 (12.) 54.5 (8.) 55.0 (29.)
 Trefferlage 1.28 mm links, 0.25 mm tief
 Streuwert 1.25, horizontal: 1.34, vertikal: 1.15

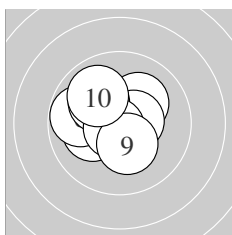
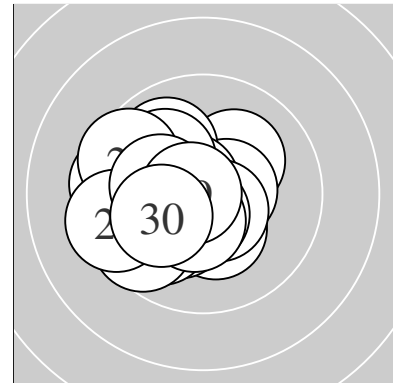

Serie 1:
 10.6 * 10.2 * 10.2 * 10.5 * 10.1 ←
 9.8 ← 10.1 ↘ 10.7 * 10.3 * 9.9 ↘
 beste Teiler 54.5 (8.) 76.9 (1.) 103.4 (4.)
 Trefferlage 0.70 mm links, 0.36 mm hoch
 Streuwert 1.28, horizontal: 1.40, vertikal: 1.15

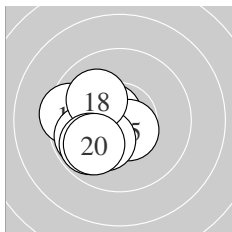

Serie 2:
 10.7 * 10.7 * 9.5 ← 10.6 * 10.6 *
 9.8 ← 10.2 * 10.1 ↘ 9.8 ↙ 9.9 ↙
 beste Teiler 51.4 (12.) 74.0 (11.) 77.1 (14.)
 Trefferlage 1.39 mm links, 0.49 mm tief
 Streuwert 1.16, horizontal: 1.24, vertikal: 1.08

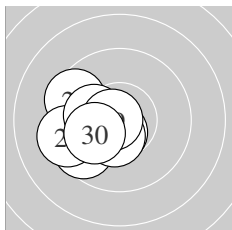

Serie 3:
 10.7 * 9.5 ↘ 9.8 ↙ 10.6 * 9.6 ↙
 10.5 * 9.4 ← 10.2 * 10.7 * 10.1 ←
 beste Teiler 55.0 (29.) 67.1 (21.) 92.1 (24.)
 Trefferlage 1.75 mm links, 0.63 mm tief
 Streuwert 1.17, horizontal: 1.28, vertikal: 1.06

Unterschrift des Schützen

Ergebnis: **309.7** (296)
 Serien: 102.8 103.0 103.9
 Zähler: 26 4 0 0 0 0 0 0 0 0
 Innenzehner: 21
 weiteste: 320 (13), 291 (9), 289 (28)
 beste Teiler 27.4 (12.) 32.2 (29.) 44.1 (17.)
 Trefferlage 0.61 mm links, 0.00 mm
 Streuwert 1.18, horizontal: 1.11, vertikal: 1.25

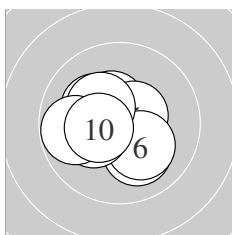
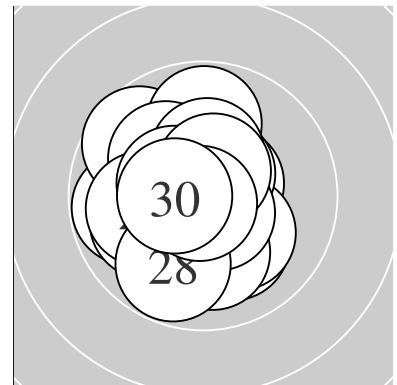

Serie 1:
 10.4 * 10.1 ↘ 10.7 * 10.2 * 10.5 *
 10.2 * 10.2 * 10.3 * 9.8 ← 10.4 *
 beste Teiler 63.9 (3.) 103.3 (5.) 126.6 (1.)
 Trefferlage 0.64 mm links, 0.07 mm tief
 Streuwert 1.23, horizontal: 1.39, vertikal: 1.05

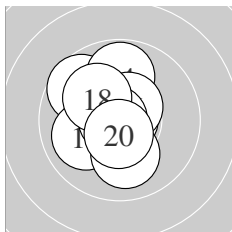

Serie 2:
 10.6 * 10.8 * 9.7 ↘ 9.8 ↑ 10.0 ←
 10.5 * 10.8 * 10.1 ↘ 10.1 ↓ 10.6 *
 beste Teiler 27.4 (12.) 44.1 (17.) 90.1 (20.)
 Trefferlage 0.56 mm links, 0.22 mm hoch
 Streuwert 1.35, horizontal: 1.09, vertikal: 1.56

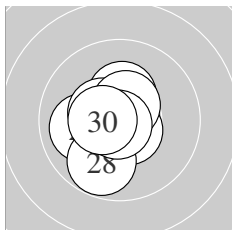

Serie 3:
 10.3 * 10.6 * 10.6 * 10.3 * 10.0 ←
 10.5 * 10.5 * 9.8 ↓ 10.8 * 10.5 *
 beste Teiler 32.2 (29.) 86.5 (22.) 91.7 (23.)
 Trefferlage 0.63 mm links, 0.12 mm tief
 Streuwert 1.06, horizontal: 0.90, vertikal: 1.19

Unterschrift des Schützen

Ergebnis: **294.0** (281)
 Serien: 98.3 98.4 97.3
 Zähler: 13 15 2 0 0 0 0 0 0 0
 Innenzehner: 6
 weiteste: 658 (21), 562 (13), 473 (2)
 beste Teiler 61.0 (20.) 103.0 (18.) 126.8 (28.)
 Trefferlage 0.35 mm rechts, 1.22 mm hoch
 Streuwert 2.08, horizontal: 2.47, vertikal: 1.61

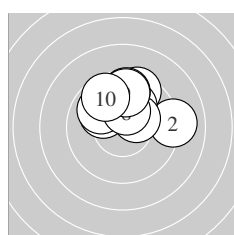
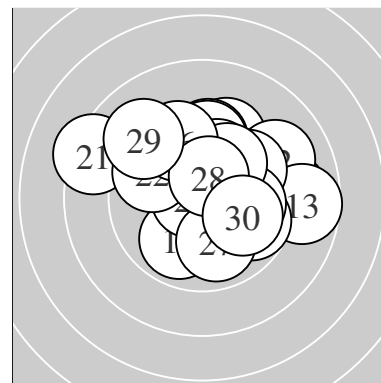

Serie 1:
 10.1 ↘ 9.1 → 9.9 ↘ 9.5 ↗ 10.1 ↗
 10.3 * 9.6 ↑ 10.3 * 9.7 ↑ 9.7 ↘
 beste Teiler 152.3 (6.) 155.2 (8.) 217.7 (1.)
 Trefferlage 0.39 mm rechts, 2.02 mm hoch
 Streuwert 1.60, horizontal: 1.98, vertikal: 1.09

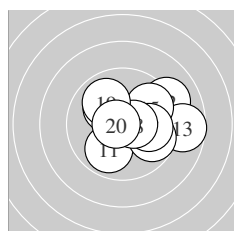

Serie 2:
 9.9 ↙ 9.1 ↗ 8.7 → 9.7 ↘ 9.8 ↗
 10.1 ↘ 10.0 → 10.5 * 9.9 ↘ 10.7 *
 beste Teiler 61.0 (20.) 103.0 (18.) 209.3 (16.)
 Trefferlage 1.35 mm rechts, 0.30 mm hoch
 Streuwert 2.07, horizontal: 2.52, vertikal: 1.48

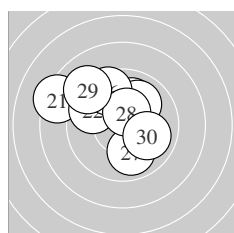

Serie 3:
 8.3 ↘ 9.7 ↘ 10.3 * 10.0 ↗ 10.0 ↗
 9.6 ↘ 9.9 ↓ 10.4 * 9.1 ↘ 10.0 ↘
 beste Teiler 126.8 (28.) 160.8 (23.) 233.6 (24.)
 Trefferlage 0.67 mm links, 1.35 mm hoch
 Streuwert 2.26, horizontal: 2.64, vertikal: 1.81

Unterschrift des Schützen

Ergebnis: **310.7** (294)
 Serien: 102.8 104.1 103.8
 Zähler: 24 6 0 0 0 0 0 0 0 0
 Innenzehner: 23
 weiteste: 331 (9), 312 (29), 293 (7)
 beste Teiler 15.0 (30.) 41.7 (28.) 59.7 (20.)
 Trefferlage 0.77 mm links, 0.04 mm hoch
 Streuwert 1.11, horizontal: 1.26, vertikal: 0.93

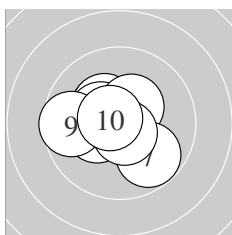
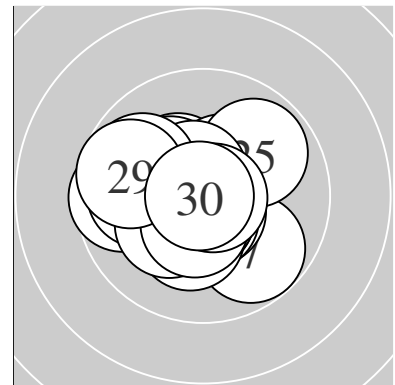

Serie 1:
 10.3 * 10.3 * 10.3 * 10.3 * 10.4 *
 10.4 * 9.8 ↘ 10.7 * 9.6 ← 10.7 *
 beste Teiler 73.8 (8.) 74.7 (10.) 139.0 (6.)
 Trefferlage 0.75 mm links, 0.05 mm hoch
 Streuwert 1.28, horizontal: 1.48, vertikal: 1.04

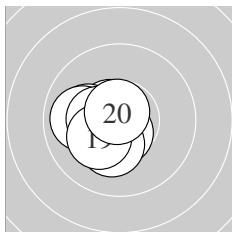

Serie 2:
 10.6 * 10.1 ← 10.7 * 10.6 * 10.6 *
 9.9 ← 10.4 * 10.3 * 10.2 * 10.7 *
 beste Teiler 59.7 (20.) 70.0 (13.) 81.6 (15.)
 Trefferlage 1.03 mm links, 0.20 mm tief
 Streuwert 0.80, horizontal: 0.85, vertikal: 0.76

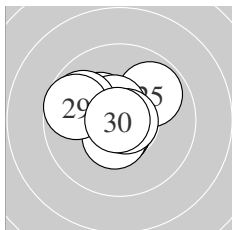

Serie 3:
 10.6 * 10.3 * 10.7 * 10.5 * 9.9 ↗
 10.6 * 9.8 ↖ 10.8 * 9.7 ← 10.9 *
 beste Teiler 15.0 (30.) 41.7 (28.) 75.3 (23.)
 Trefferlage 0.54 mm links, 0.29 mm hoch
 Streuwert 1.24, horizontal: 1.45, vertikal: 0.99

Unterschrift des Schützen

Ergebnis: **313.6** (299)
 Serien: 103.6 105.1 104.9
 Zähler: 29 1 0 0 0 0 0 0 0 0
 Innenzehner: 28
 weiteste: 290 (5), 214 (18), 192 (26)
 beste Teiler 8.0 (20.) 27.7 (21.) 31.2 (13.)
 Trefferlage 0.62 mm links, 0.15 mm hoch
 Streuwert 0.89, horizontal: 0.82, vertikal: 0.95

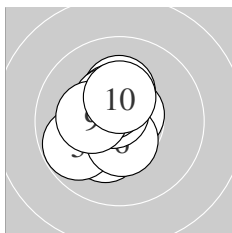
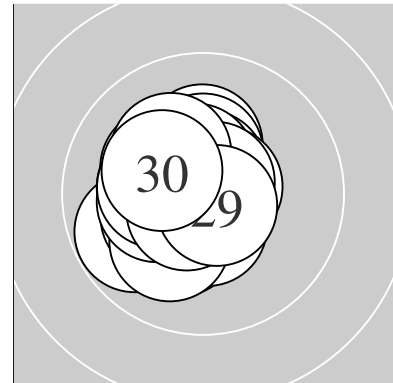

Serie 1:
 10.2 * 10.7 * 10.2 * 10.4 * 9.8 ↙
 10.5 * 10.7 * 10.4 * 10.3 * 10.4 *
 beste Teiler 67.0 (2.) 70.0 (7.) 118.8 (6.)
 Trefferlage 0.59 mm links, 0.27 mm hoch
 Streuwert 1.10, horizontal: 0.92, vertikal: 1.25

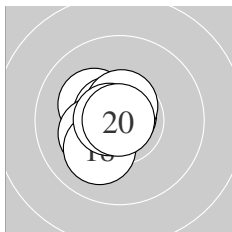

Serie 2:
 10.5 * 10.2 * 10.8 * 10.6 * 10.6 *
 10.5 * 10.2 * 10.1 ↙ 10.7 * 10.9 *
 beste Teiler 8.0 (20.) 31.2 (13.) 63.1 (19.)
 Trefferlage 0.74 mm links, 0.11 mm tief
 Streuwert 0.75, horizontal: 0.63, vertikal: 0.85

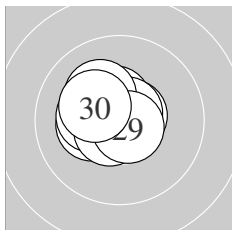

Serie 3:
 10.8 * 10.5 * 10.6 * 10.3 * 10.7 *
 10.2 * 10.3 * 10.6 * 10.7 * 10.2 *
 beste Teiler 27.7 (21.) 60.8 (25.) 66.7 (29.)
 Trefferlage 0.52 mm links, 0.28 mm hoch
 Streuwert 0.84, horizontal: 0.96, vertikal: 0.71

Unterschrift des Schützen

Ergebnis: **308.2** (297)
 Serien: 102.0 103.3 102.9
 Zähler: 27 3 0 0 0 0 0 0 0 0
 Innenzehner: 21
 weiteste: 405 (7), 327 (10), 276 (11)
 beste Teiler 47.1 (18.) 67.9 (3.) 70.0 (12.)
 Trefferlage 0.59 mm rechts, 0.27 mm tief
 Streuwert 1.26, horizontal: 1.26, vertikal: 1.25

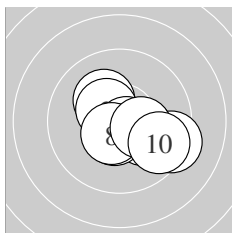
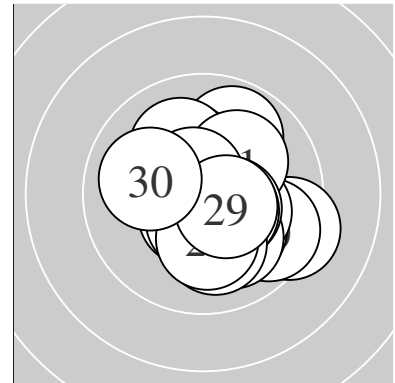

Serie 1:
 10.2 * 10.4 * 10.7 * 10.3 * 10.2 *
 10.5 * 9.3 ↘ 10.5 * 10.3 * 9.6 ↘
 beste Teiler 67.9 (3.) 104.7 (6.) 107.0 (8.)
 Trefferlage 0.90 mm rechts, 0.50 mm tief
 Streuwert 1.38, horizontal: 1.68, vertikal: 0.99

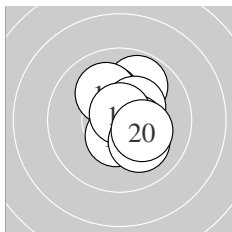

Serie 2:
 9.8 ↗ 10.7 * 10.2 * 10.1 ↖ 10.4 *
 10.5 * 10.5 * 10.8 * 10.1 ↘ 10.2 *
 beste Teiler 47.1 (18.) 70.0 (12.) 115.7 (17.)
 Trefferlage 0.45 mm rechts, 0.30 mm hoch
 Streuwert 1.21, horizontal: 0.95, vertikal: 1.42

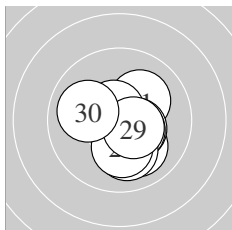

Serie 3:
 10.1 ↗ 10.0 ↘ 10.4 * 10.6 * 10.6 *
 10.4 * 10.1 ↓ 10.2 * 10.5 * 10.0 ↖
 beste Teiler 78.7 (25.) 99.6 (24.) 114.6 (29.)
 Trefferlage 0.42 mm rechts, 0.61 mm tief
 Streuwert 1.17, horizontal: 1.13, vertikal: 1.21

Unterschrift des Schützen

Ergebnis: **315.0** (299)
 Serien: 104.4 104.6 106.0
 Zähler: 29 1 0 0 0 0 0 0 0 0
 Innenzehner: 27
 weiteste: 320 (7), 233 (18), 204 (1)
 beste Teiler 9.4 (26.) 14.4 (19.) 47.3 (23.)
 Trefferlage 0.20 mm links, 0.07 mm hoch
 Streuwert 0.94, horizontal: 0.86, vertikal: 1.01

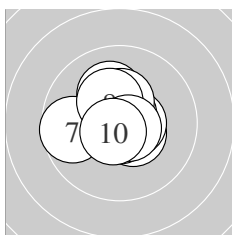
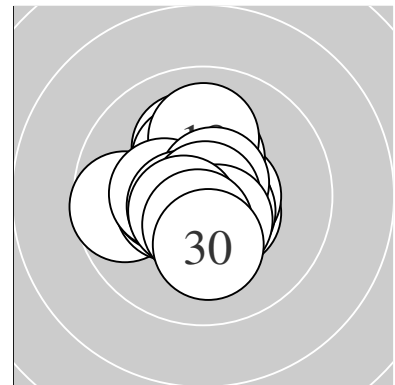

Serie 1:
 10.1 ↑ 10.5 * 10.6 * 10.7 * 10.7 *
 10.4 * 9.7 ← 10.3 * 10.7 * 10.7 *
 beste Teiler 51.0 (4.) 62.1 (5.) 67.2 (9.)
 Trefferlage 0.21 mm links, 0.28 mm hoch
 Streuwert 1.10, horizontal: 1.19, vertikal: 0.99

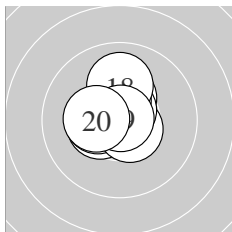

Serie 2:
 10.3 * 10.4 * 10.6 * 10.4 * 10.6 *
 10.7 * 10.4 * 10.0 ↑ 10.9 * 10.3 *
 beste Teiler 14.4 (19.) 72.4 (16.) 91.6 (13.)
 Trefferlage 0.32 mm links, 0.59 mm hoch
 Streuwert 0.87, horizontal: 0.81, vertikal: 0.93

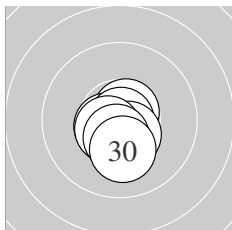

Serie 3:
 10.7 * 10.6 * 10.8 * 10.6 * 10.6 *
 10.9 * 10.5 * 10.6 * 10.5 * 10.2 *
 beste Teiler 9.4 (26.) 47.3 (23.) 69.0 (21.)
 Trefferlage 0.08 mm links, 0.66 mm tief
 Streuwert 0.60, horizontal: 0.53, vertikal: 0.67

Unterschrift des Schützen

Ergebnis: **307.2** (295)
 Serien: 102.2 102.5 102.5
 Zähler: 25 5 0 0 0 0 0 0 0 0
 Innenzehner: 19
 weiteste: 290 (9), 286 (10), 282 (25)
 beste Teiler 63.6 (27.) 96.1 (7.) 96.6 (17.)
 Trefferlage 0.53 mm links, 0.36 mm hoch
 Streuwert 1.27, horizontal: 1.03, vertikal: 1.48

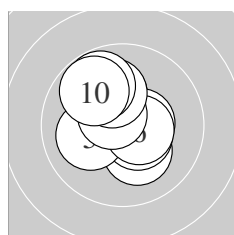
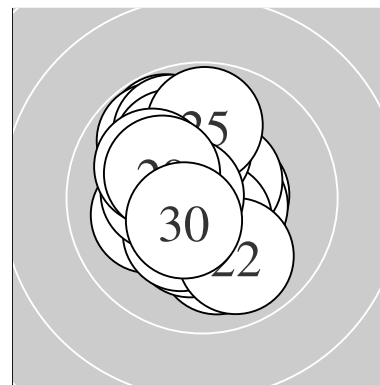

Serie 1:
 10.2 * 10.1 ↗ 10.5 * 10.5 * 10.1 ←
 10.5 * 10.6 * 10.1 ↗ 9.8 ↘ 9.8 ↘
 beste Teiler 96.1 (7.) 111.1 (6.) 113.6 (3.)
 Trefferlage 0.31 mm links, 0.63 mm hoch
 Streuwert 1.37, horizontal: 1.26, vertikal: 1.47

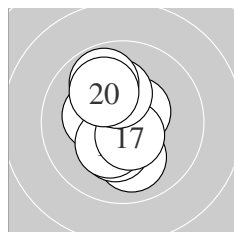

Serie 2:
 10.5 * 10.3 * 10.0 ↓ 10.5 * 10.3 *
 10.3 * 10.6 * 10.2 * 9.8 ↘ 10.0 ↘
 beste Teiler 96.6 (17.) 109.0 (14.) 110.6 (11.)
 Trefferlage 0.43 mm links, 0.04 mm hoch
 Streuwert 1.33, horizontal: 0.84, vertikal: 1.68

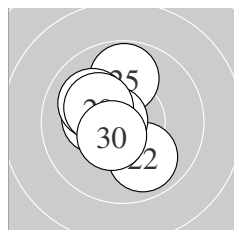

Serie 3:
 10.3 * 9.9 ↘ 10.3 * 10.5 * 9.8 ↑
 10.3 * 10.7 * 10.0 ↘ 10.2 * 10.5 *
 beste Teiler 63.6 (27.) 111.6 (30.) 124.6 (24.)
 Trefferlage 0.85 mm links, 0.42 mm hoch
 Streuwert 1.18, horizontal: 0.97, vertikal: 1.36

Unterschrift des Schützen

Meyton Elektronik

Ergebnis: **314.5** (299)
 Serien: 104.7 104.0 105.8
 Zähler: 29 1 0 0 0 0 0 0 0 0
 Innenzehner: 27
 weiteste: 311 (1), 226 (24), 223 (2)
 beste Teiler 15.6 (30.) 19.6 (10.) 19.7 (13.)
 Trefferlage 0.20 mm links, 0.19 mm tief
 Streuwert 0.98, horizontal: 1.06, vertikal: 0.89

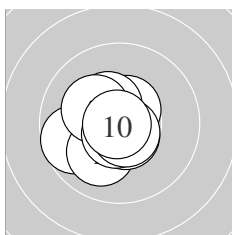
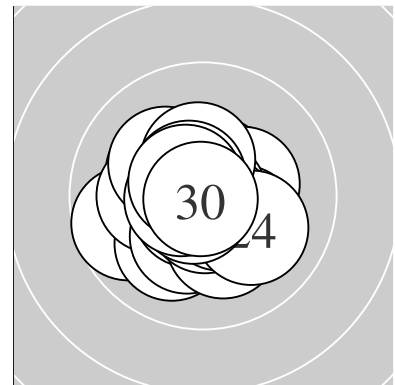

Serie 1:
 9.7 ← 10.1 ↙ 10.6 * 10.6 * 10.4 *
 10.8 * 10.2 * 10.7 * 10.7 * 10.9 *
 beste Teiler 19.6 (10.) 35.3 (6.) 73.2 (9.)
 Trefferlage 0.59 mm links, 0.24 mm tief
 Streuwert 1.02, horizontal: 1.07, vertikal: 0.97

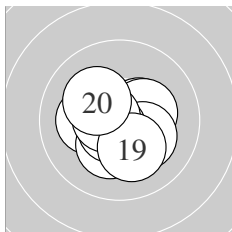

Serie 2:
 10.2 * 10.4 * 10.9 * 10.3 * 10.2 *
 10.3 * 10.7 * 10.6 * 10.2 * 10.2 *
 beste Teiler 19.7 (13.) 75.0 (17.) 89.1 (18.)
 Trefferlage 0.04 mm links, 0.27 mm tief
 Streuwert 1.12, horizontal: 1.26, vertikal: 0.97

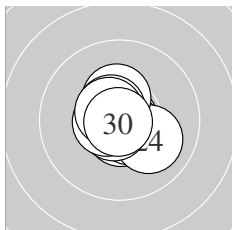

Serie 3:
 10.6 * 10.8 * 10.6 * 10.0 ↘ 10.4 *
 10.7 * 10.6 * 10.6 * 10.6 * 10.9 *
 beste Teiler 15.6 (30.) 26.0 (22.) 56.6 (26.)
 Trefferlage 0.01 mm rechts, 0.06 mm tief
 Streuwert 0.80, horizontal: 0.80, vertikal: 0.79

Unterschrift des Schützen

Ergebnis: **310.6** (295)
 Serien: 104.5 101.8 104.3
 Zähler: 25 5 0 0 0 0 0 0 0 0
 Innenzehner: 22
 weiteste: 314 (13), 281 (19), 277 (17)
 beste Teiler 9.2 (3.) 21.2 (6.) 34.8 (26.)
 Trefferlage 0.00 mm , 0.03 mm tief
 Streuwert 1.23, horizontal: 1.28, vertikal: 1.17

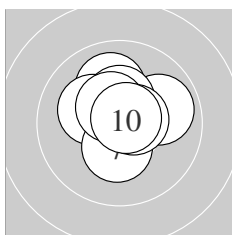
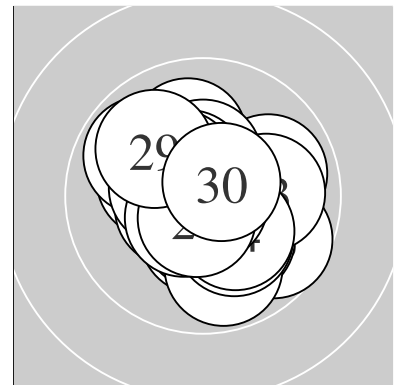

Serie 1:
 9.9 → 10.0 ↑ 10.9 * 10.4 * 10.2 *
 10.9 * 10.4 * 10.5 * 10.6 * 10.7 *
 beste Teiler 9.2 (3.) 21.2 (6.) 52.6 (10.)
 Trefferlage 0.08 mm rechts, 0.56 mm hoch
 Streuwert 1.04, horizontal: 1.08, vertikal: 0.99

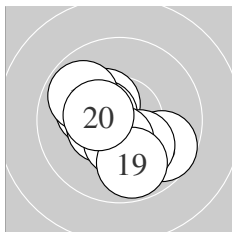

Serie 2:
 10.2 * 10.4 * 9.7 ↘ 10.5 * 10.5 *
 10.1 ↘ 9.8 ↖ 10.4 * 9.8 ↓ 10.4 *
 beste Teiler 115.2 (14.) 119.7 (15.) 130.1 (18.)
 Trefferlage 0.39 mm links, 0.38 mm tief
 Streuwert 1.46, horizontal: 1.55, vertikal: 1.37

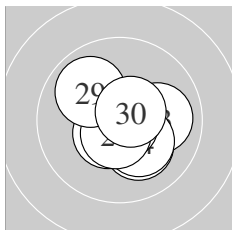

Serie 3:
 10.2 * 10.7 * 10.0 → 10.2 * 10.8 *
 10.8 * 10.5 * 10.6 * 9.9 ↖ 10.6 *
 beste Teiler 34.8 (26.) 43.9 (25.) 67.2 (22.)
 Trefferlage 0.31 mm rechts, 0.28 mm tief
 Streuwert 1.09, horizontal: 1.19, vertikal: 0.97

Unterschrift des Schützen

Ergebnis: **315.7** (300)
 Serien: 104.7 105.1 105.9
 Zähler: 30 0 0 0 0 0 0 0 0 0
 Innenzehner: 28
 weiteste: 225 (6), 211 (28), 193 (1)
 beste Teiler 16.6 (8.) 17.8 (22.) 33.1 (4.)
 Trefferlage 0.00 mm , 0.01 mm tief
 Streuwert 0.88, horizontal: 0.87, vertikal: 0.89

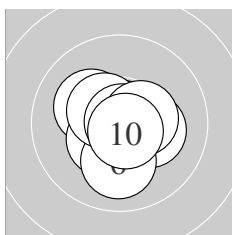
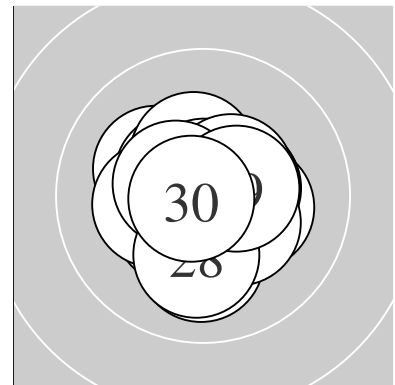

Serie 1:
 10.2 * 10.5 * 10.2 * 10.8 * 10.4 *
 10.1 ↓ 10.5 * 10.9 * 10.4 * 10.7 *
 beste Teiler 16.6 (8.) 33.1 (4.) 58.6 (10.)
 Trefferlage 0.10 mm rechts, 0.15 mm tief
 Streuwert 1.00, horizontal: 1.07, vertikal: 0.93

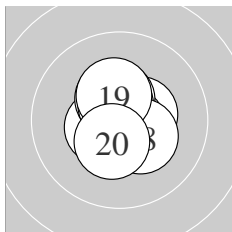

Serie 2:
 10.5 * 10.7 * 10.5 * 10.5 * 10.8 *
 10.4 * 10.6 * 10.3 * 10.4 * 10.4 *
 beste Teiler 46.4 (15.) 54.1 (12.) 91.9 (17.)
 Trefferlage 0.04 mm rechts, 0.18 mm hoch
 Streuwert 0.87, horizontal: 0.74, vertikal: 0.99

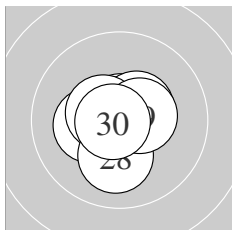

Serie 3:
 10.3 * 10.9 * 10.8 * 10.7 * 10.8 *
 10.5 * 10.5 * 10.1 ↓ 10.5 * 10.8 *
 beste Teiler 17.8 (22.) 41.2 (25.) 43.1 (30.)
 Trefferlage 0.16 mm links, 0.06 mm tief
 Streuwert 0.82, horizontal: 0.84, vertikal: 0.80

Unterschrift des Schützen

Ergebnis: **299.2** (288)
 Serien: 99.1 100.9 99.2
 Zähler: 19 10 1 0 0 0 0 0 0 0
 Innenzehner: 15
 weiteste: 509 (12), 458 (28), 444 (1)
 beste Teiler 88.6 (2.) 96.0 (6.) 101.5 (24.)
 Trefferlage 0.73 mm links, 0.20 mm hoch
 Streuwert 1.88, horizontal: 2.02, vertikal: 1.74

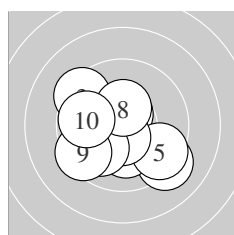
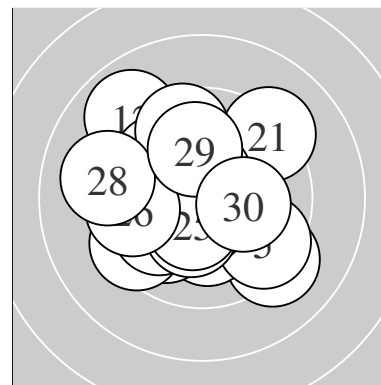

Serie 1:
 9.2 ↘ 10.6 * 9.4 ↘ 10.2 * 9.5 ↘
 10.6 * 10.0 ↙ 10.4 * 9.4 ↙ 9.8 ←
 beste Teiler 88.6 (2.) 96.0 (6.) 137.0 (8.)
 Trefferlage 0.41 mm links, 0.68 mm tief
 Streuwert 2.08, horizontal: 2.34, vertikal: 1.79

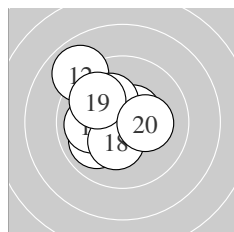

Serie 2:
 10.4 * 8.9 ↘ 10.5 * 10.5 * 10.2 *
 10.0 ↙ 10.0 ← 10.3 * 9.9 ↘ 10.2 *
 beste Teiler 107.0 (13.) 120.0 (14.) 127.4 (11.)
 Trefferlage 1.06 mm links, 0.36 mm hoch
 Streuwert 1.60, horizontal: 1.53, vertikal: 1.66

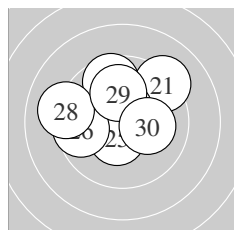

Serie 3:
 9.2 ↗ 10.4 * 10.2 * 10.5 * 10.4 *
 9.6 ← 9.6 ↑ 9.1 ← 10.0 ↑ 10.2 *
 beste Teiler 101.5 (24.) 126.8 (25.) 139.6 (22.)
 Trefferlage 0.73 mm links, 0.93 mm hoch
 Streuwert 1.92, horizontal: 2.25, vertikal: 1.51

Unterschrift des Schützen

Meyton Elektronik

Ergebnis: **302.3** (289)
 Serien: 101.9 98.9 101.5
 Zähler: 20 9 1 0 0 0 0 0 0 0
 Innenzehner: 14
 weiteste: 502 (15), 484 (17), 407 (18)
 beste Teiler 33.1 (23.) 39.0 (7.) 44.2 (9.)
 Trefferlage 0.40 mm rechts, 1.47 mm tief
 Streuwert 1.44, horizontal: 1.46, vertikal: 1.42

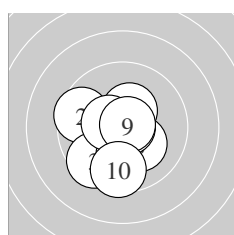
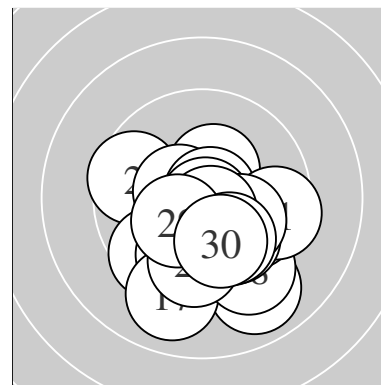

Serie 1:
 10.4 * 9.6 ← 9.6 ↙ 10.3 * 10.1 ↓
 10.2 * 10.8 * 10.5 * 10.8 * 9.6 ↓
 beste Teiler 39.0 (7.) 44.2 (9.) 113.8 (8.)
 Trefferlage 0.34 mm links, 0.81 mm tief
 Streuwert 1.53, horizontal: 1.45, vertikal: 1.61

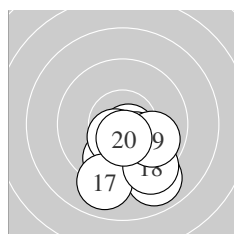

Serie 2:
 10.6 * 10.1 ↘ 10.3 * 9.8 ↓ 8.9 ↘
 10.5 * 9.0 ↓ 9.3 ↘ 9.9 ↘ 10.5 *
 beste Teiler 78.0 (11.) 113.5 (20.) 118.8 (16.)
 Trefferlage 0.71 mm rechts, 2.19 mm tief
 Streuwert 1.45, horizontal: 1.44, vertikal: 1.47

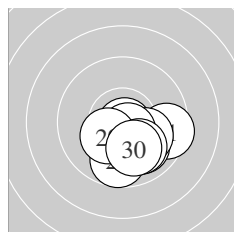

Serie 3:
 9.5 → 10.0 ↘ 10.8 * 10.5 * 10.1 ↘
 10.6 * 9.7 ↓ 10.0 ↘ 10.3 * 10.0 ↓
 beste Teiler 33.1 (23.) 81.6 (26.) 125.5 (24.)
 Trefferlage 0.86 mm rechts, 1.40 mm tief
 Streuwert 1.09, horizontal: 1.30, vertikal: 0.82

Unterschrift des Schützen

Ergebnis: **295.0** (281)
 Serien: 101.2 96.5 97.3
 Zähler: 14 13 3 0 0 0 0 0 0 0
 Innenzehner: 11
 weiteste: 632 (16), 626 (28), 529 (26)
 beste Teiler 46.6 (6.) 97.1 (2.) 118.0 (30.)
 Trefferlage 0.88 mm rechts, 0.54 mm hoch
 Streuwert 2.15, horizontal: 2.38, vertikal: 1.90

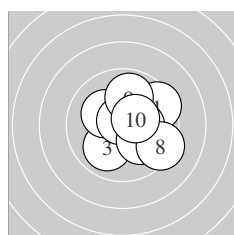
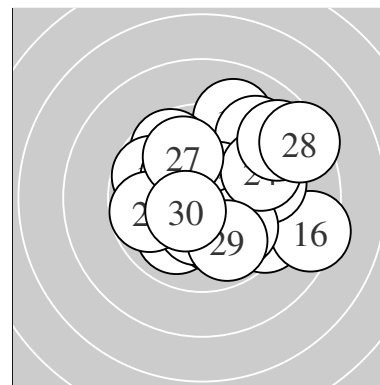

Serie 1:
 9.5 ↗ 10.6 * 10.0 ↘ 10.2 * 10.3 *
 10.8 * 10.1 ↘ 9.4 ↘ 9.9 ↑ 10.4 *
 beste Teiler 46.6 (6.) 97.1 (2.) 133.7 (10.)
 Trefferlage 0.76 mm rechts, 0.13 mm hoch
 Streuwert 1.68, horizontal: 1.82, vertikal: 1.53

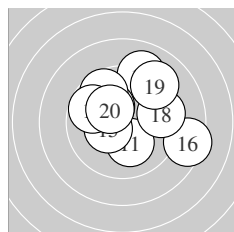

Serie 2:
 10.1 ↘ 9.1 ↑ 10.2 * 9.7 ↖ 10.4 *
 8.4 → 9.7 ↖ 9.5 → 9.1 ↗ 10.3 *
 beste Teiler 147.6 (15.) 168.2 (20.) 184.6 (13.)
 Trefferlage 0.68 mm rechts, 1.08 mm hoch
 Streuwert 2.50, horizontal: 2.84, vertikal: 2.10

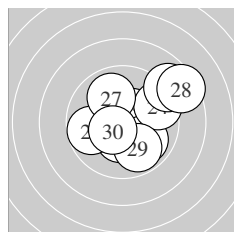

Serie 3:
 10.3 * 10.5 * 9.9 ↘ 9.5 ↗ 9.7 ←
 8.8 ↗ 9.9 ↖ 8.4 ↗ 9.8 ↘ 10.5 *
 beste Teiler 118.0 (30.) 125.8 (22.) 153.0 (21.)
 Trefferlage 1.20 mm rechts, 0.40 mm hoch
 Streuwert 2.35, horizontal: 2.60, vertikal: 2.07

Unterschrift des Schützen

Meyton Elektronik

Ergebnis: **311.0** (297)
 Serien: 102.8 105.1 103.1
 Zähler: 27 3 0 0 0 0 0 0 0 0
 Innenzehner: 24
 weiteste: 370 (2), 323 (29), 283 (10)
 beste Teiler 32.8 (18.) 40.3 (15.) 46.4 (7.)
 Trefferlage 0.26 mm links, 0.26 mm tief
 Streuwert 1.17, horizontal: 1.38, vertikal: 0.92

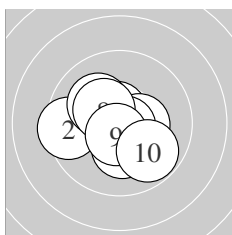
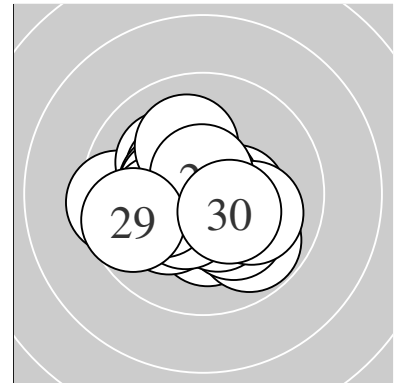

Serie 1:
 10.4 * 9.5 ← 10.6 * 10.1 ↘ 10.2 *
 10.4 * 10.8 * 10.4 * 10.6 * 9.8 ↘
 beste Teiler 46.4 (7.) 81.9 (3.) 85.1 (9.)
 Trefferlage 0.16 mm links, 0.26 mm tief
 Streuwert 1.41, horizontal: 1.66, vertikal: 1.10

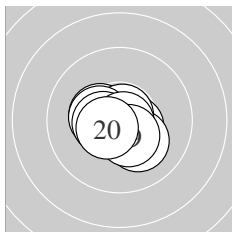

Serie 2:
 10.4 * 10.6 * 10.5 * 10.2 * 10.8 *
 10.4 * 10.5 * 10.8 * 10.4 * 10.5 *
 beste Teiler 32.8 (18.) 40.3 (15.) 81.0 (12.)
 Trefferlage 0.23 mm links, 0.30 mm tief
 Streuwert 0.85, horizontal: 1.03, vertikal: 0.62

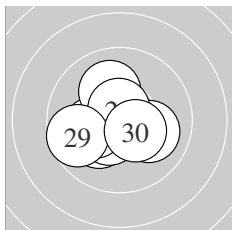

Serie 3:
 10.2 * 10.4 * 10.7 * 10.7 * 10.2 *
 10.1 ↑ 10.1 → 10.6 * 9.7 ← 10.4 *
 beste Teiler 51.0 (23.) 63.1 (24.) 77.2 (28.)
 Trefferlage 0.40 mm links, 0.23 mm tief
 Streuwert 1.29, horizontal: 1.50, vertikal: 1.05

Unterschrift des Schützen

Ergebnis: **298.3** (286)
 Serien: 100.5 97.7 100.1
 Zähler: 18 11 0 1 0 0 0 0 0 0
 Innenzehner: 11
 weiteste: 751 (24), 426 (7), 420 (20)
 beste Teiler 52.6 (10.) 71.5 (15.) 79.0 (4.)
 Trefferlage 0.60 mm rechts, 0.31 mm hoch
 Streuwert 2.01, horizontal: 2.35, vertikal: 1.61

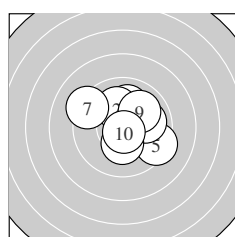
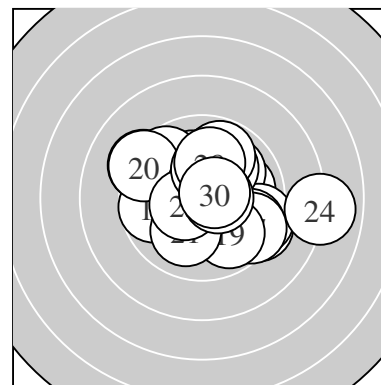

Serie 1:
 10.0 ↑ 10.1 ↖ 10.2 * 10.6 * 9.4 ↘
 10.0 → 9.2 ↙ 10.3 * 10.0 ↗ 10.7 *
 beste Teiler 52.6 (10.) 79.0 (4.) 169.0 (8.)
 Trefferlage 0.62 mm rechts, 0.33 mm hoch
 Streuwert 1.80, horizontal: 1.99, vertikal: 1.58

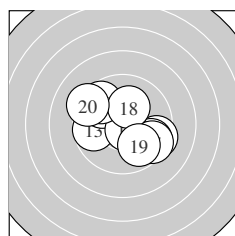

Serie 2:
 9.4 ↘ 9.6 ↘ 9.7 ← 9.8 ↙ 10.7 *
 9.7 ↙ 9.5 ↘ 10.2 * 9.8 ↘ 9.3 ↙
 beste Teiler 71.5 (15.) 191.3 (18.) 279.5 (14.)
 Trefferlage 0.13 mm rechts, 0.03 mm tief
 Streuwert 2.32, horizontal: 2.74, vertikal: 1.82

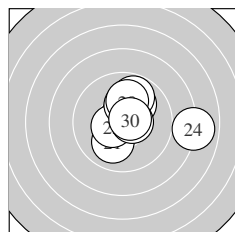

Serie 3:
 10.0 ↘ 10.6 * 10.0 ↗ 7.9 → 10.5 *
 10.2 * 9.8 ↑ 10.0 ↑ 10.5 * 10.6 *
 beste Teiler 85.6 (30.) 95.5 (22.) 101.0 (29.)
 Trefferlage 1.04 mm rechts, 0.66 mm hoch
 Streuwert 2.01, horizontal: 2.41, vertikal: 1.51

Unterschrift des Schützen

Meyton Elektronik

Ergebnis: **293.4** (282)
 Serien: 102.5 91.1 99.8
 Zähler: 21 8 0 0 0 0 0 0 0 0
 Innenzehner: 13
 weiteste: 5102 (14), 366 (28), 331 (23)
 beste Teiler 48.4 (9.) 76.2 (26.) 97.1 (5.)
 Trefferlage 0.58 mm rechts, 3.01 mm tief
 Streuwert 6.51, horizontal: 1.29, vertikal: 9.12

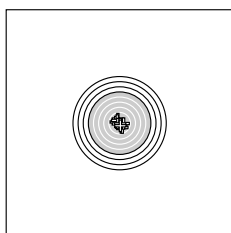
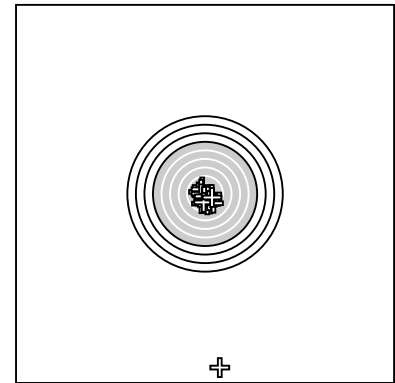

Serie 1:
 10.1 ↗ 10.2 * 10.2 * 10.0 ↘ 10.6 *
 10.1 ↘ 9.9 ↘ 10.2 * 10.8 * 10.4 *
 beste Teiler 48.4 (9.) 97.1 (5.) 132.2 (10.)
 Trefferlage 0.10 mm rechts, 0.44 mm tief
 Streuwert 1.35, horizontal: 1.25, vertikal: 1.45

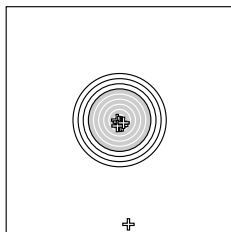

Serie 2:
 10.4 * 10.2 * 10.2 * 0.0 ↓ 9.8 ↓
 10.5 * 10.5 * 9.8 ↘ 9.7 ↘ 10.0 ↘
 beste Teiler 103.6 (17.) 117.0 (16.) 131.7 (11.)
 Trefferlage 0.66 mm rechts, 6.60 mm tief
 Streuwert 11.07, horizontal: 1.59, vertikal: 15.57

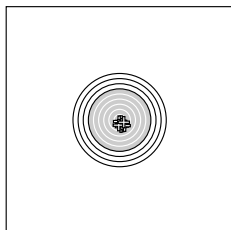

Serie 3:
 10.5 * 10.1 ↘ 9.6 ↘ 10.0 ↘ 9.6 ↓
 10.6 * 10.0 ↘ 9.5 ↘ 9.9 ↓ 10.0 ↘
 beste Teiler 76.2 (26.) 102.8 (21.) 214.7 (22.)
 Trefferlage 0.97 mm rechts, 1.99 mm tief
 Streuwert 0.90, horizontal: 0.90, vertikal: 0.91

Unterschrift des Schützen

Ergebnis: **298.0** (286)
 Serien: 99.9 98.2 99.9
 Zähler: 17 12 1 0 0 0 0 0 0 0
 Innenzehner: 6
 weiteste: 609 (12), 376 (22), 367 (13)
 beste Teiler 90.4 (26.) 127.0 (18.) 154.3 (8.)
 Trefferlage 0.80 mm rechts, 0.70 mm hoch
 Streuwert 1.78, horizontal: 1.66, vertikal: 1.89

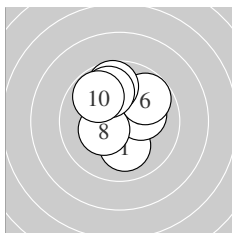
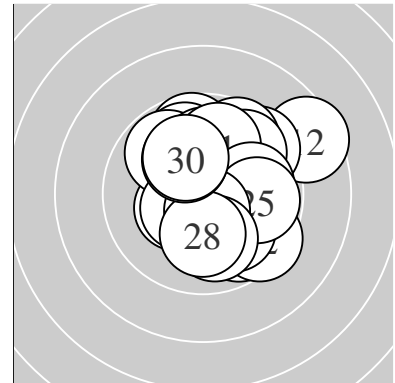

Serie 1:
 10.1 ↓ 10.1 ↑ 10.0 ↘ 10.0 ↑ 10.2 *
 9.8 ↗ 9.7 ↑ 10.3 * 9.9 ↑ 9.8 ↘
 beste Teiler 154.3 (8.) 194.8 (5.) 204.6 (2.)
 Trefferlage 0.13 mm links, 1.35 mm hoch
 Streuwert 1.52, horizontal: 1.40, vertikal: 1.62

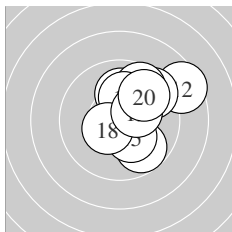

Serie 2:
 9.8 ↘ 8.5 ↗ 9.5 ↗ 10.0 ↑ 10.3 *
 9.6 ↗ 10.1 ↑ 10.4 * 10.3 * 9.7 ↗
 beste Teiler 127.0 (18.) 166.8 (19.) 175.3 (15.)
 Trefferlage 1.59 mm rechts, 1.06 mm hoch
 Streuwert 1.82, horizontal: 1.74, vertikal: 1.90

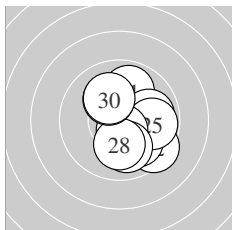

Serie 3:
 9.9 ↑ 9.4 ↘ 9.9 → 10.0 ↘ 9.8 →
 10.6 * 10.0 ↓ 10.1 ↓ 10.1 ↘ 10.1 ↘
 beste Teiler 90.4 (26.) 203.5 (29.) 209.0 (28.)
 Trefferlage 0.96 mm rechts, 0.31 mm tief
 Streuwert 1.68, horizontal: 1.46, vertikal: 1.88

Unterschrift des Schützen

Ergebnis: **307.1** (295)
 Serien: 101.2 103.9 102.0
 Zähler: 25 5 0 0 0 0 0 0 0 0
 Innenzehner: 19
 weiteste: 445 (3), 353 (24), 329 (25)
 beste Teiler 14.2 (22.) 52.9 (12.) 60.0 (27.)
 Trefferlage 0.70 mm links, 0.36 mm hoch
 Streuwert 1.33, horizontal: 1.18, vertikal: 1.47

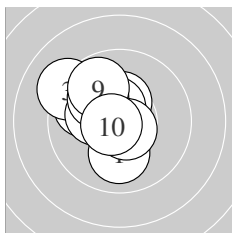
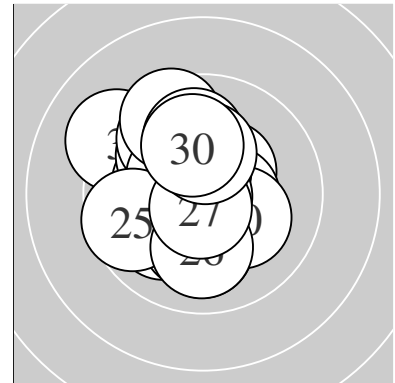

Serie 1:
 10.0 ↓ 9.8 ↖ 9.2 ↖ 10.4 * 10.2 *
 10.5 * 10.6 * 10.0 ↖ 9.8 ↖ 10.7 *
 beste Teiler 65.0 (10.) 76.6 (7.) 106.5 (6.)
 Trefferlage 1.16 mm links, 0.72 mm hoch
 Streuwert 1.40, horizontal: 1.34, vertikal: 1.45

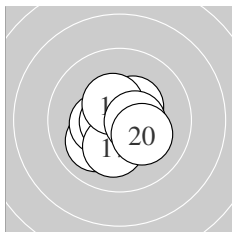

Serie 2:
 10.4 * 10.7 * 10.4 * 10.0 ↙ 10.4 *
 10.7 * 10.2 * 10.4 * 10.5 * 10.2 *
 beste Teiler 52.9 (12.) 70.8 (16.) 112.5 (19.)
 Trefferlage 0.28 mm links, 0.33 mm tief
 Streuwert 1.06, horizontal: 1.14, vertikal: 0.98

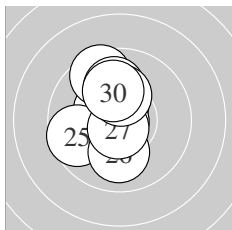

Serie 3:
 10.6 * 10.9 * 10.4 * 9.5 ↗ 9.6 ↖
 10.0 ↓ 10.7 * 10.0 ↑ 10.2 * 10.1 ↑
 beste Teiler 14.2 (22.) 60.0 (27.) 98.8 (21.)
 Trefferlage 0.67 mm links, 0.71 mm hoch
 Streuwert 1.42, horizontal: 0.98, vertikal: 1.75

Unterschrift des Schützen

Ergebnis: **299.6** (289)
 Serien: 100.9 100.9 97.8
 Zähler: 19 11 0 0 0 0 0 0 0 0
 Innenzehner: 14
 weiteste: 445 (29), 433 (27), 429 (2)
 beste Teiler 47.1 (21.) 83.2 (23.) 118.3 (5.)
 Trefferlage 0.05 mm links, 0.76 mm hoch
 Streuwert 1.81, horizontal: 1.48, vertikal: 2.09

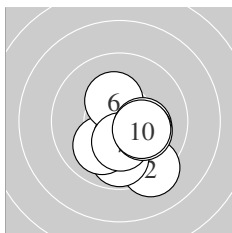
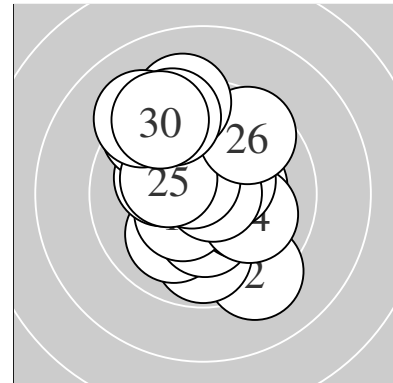

Serie 1:
 10.2 * 9.2 ↘ 9.8 ↓ 10.0 ✓ 10.5 *
 10.3 * 10.3 * 10.2 * 10.2 * 10.2 *
 beste Teiler 118.3 (5.) 159.2 (7.) 162.0 (6.)
 Trefferlage 0.68 mm rechts, 1.30 mm tief
 Streuwert 1.30, horizontal: 1.19, vertikal: 1.40

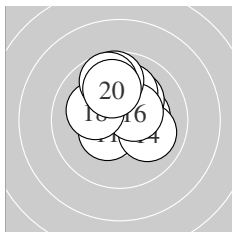

Serie 2:
 10.4 * 10.3 * 10.2 * 10.0 ↗ 10.1 ↑
 10.4 * 9.7 ↑ 10.1 ↖ 9.7 ↑ 10.0 ↑
 beste Teiler 126.6 (11.) 127.1 (16.) 168.0 (12.)
 Trefferlage 0.21 mm rechts, 1.19 mm hoch
 Streuwert 1.39, horizontal: 1.31, vertikal: 1.46

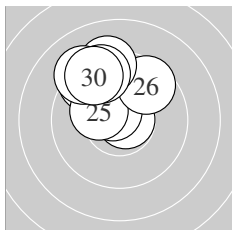

Serie 3:
 10.8 * 9.9 ↘ 10.6 * 9.4 ↘ 10.3 *
 9.6 ↗ 9.2 ↑ 9.4 ↘ 9.2 ↘ 9.4 ↘
 beste Teiler 47.1 (21.) 83.2 (23.) 174.1 (25.)
 Trefferlage 1.06 mm links, 2.38 mm hoch
 Streuwert 1.44, horizontal: 1.44, vertikal: 1.44

Unterschrift des Schützen

Ergebnis: **311.5** (297)
 Serien: 103.6 103.5 104.4
 Zähler: 27 3 0 0 0 0 0 0 0 0
 Innenzehner: 22
 weiteste: 342 (3), 322 (19), 252 (18)
 beste Teiler 25.2 (9.) 27.3 (26.) 30.0 (20.)
 Trefferlage 0.11 mm links, 0.17 mm hoch
 Streuwert 1.15, horizontal: 1.14, vertikal: 1.16

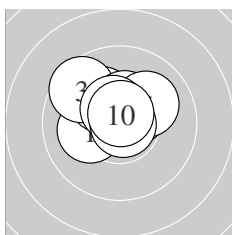
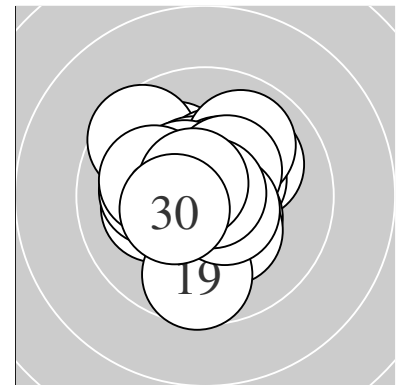

Serie 1:
 10.1 ← 10.1 ↖ 9.6 ↖ 10.4 * 10.8 *
 10.4 * 10.1 ↗ 10.5 * 10.9 * 10.7 *
 beste Teiler 25.2 (9.) 44.4 (5.) 65.4 (10.)
 Trefferlage 0.23 mm links, 0.86 mm hoch
 Streuwert 1.11, horizontal: 1.34, vertikal: 0.82

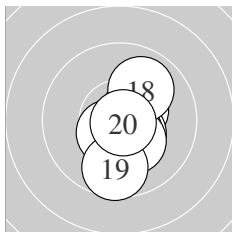

Serie 2:
 10.6 * 10.4 * 10.4 * 10.6 * 10.3 *
 10.5 * 10.3 * 9.9 ↗ 9.7 ↓ 10.8 *
 beste Teiler 30.0 (20.) 95.6 (11.) 97.1 (14.)
 Trefferlage 0.43 mm rechts, 0.69 mm tief
 Streuwert 1.10, horizontal: 0.69, vertikal: 1.39

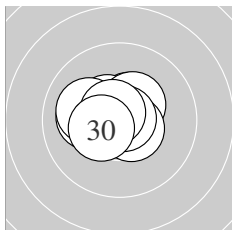

Serie 3:
 10.3 * 10.5 * 10.5 * 10.4 * 10.6 *
 10.8 * 10.1 ← 10.1 ← 10.7 * 10.4 *
 beste Teiler 27.3 (26.) 70.0 (29.) 98.2 (25.)
 Trefferlage 0.56 mm links, 0.36 mm hoch
 Streuwert 0.91, horizontal: 1.15, vertikal: 0.57

Unterschrift des Schützen

Ergebnis: **301.2** (290)
 Serien: 102.0 99.5 99.7
 Zähler: 21 8 1 0 0 0 0 0 0 0
 Innenzehner: 13
 weiteste: 624 (30), 460 (9), 428 (26)
 beste Teiler 65.2 (1.) 76.0 (15.) 81.2 (7.)
 Trefferlage 1.51 mm links, 0.17 mm hoch
 Streuwert 1.56, horizontal: 1.69, vertikal: 1.42

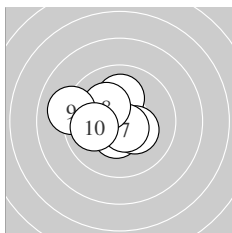
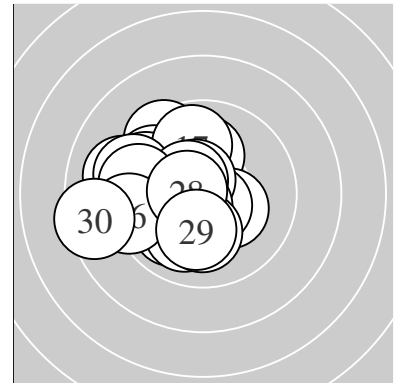

Serie 1:
 10.7 * 10.1 ↑ 10.4 * 10.5 * 10.3 *
 10.1 ← 10.6 * 10.2 * 9.1 ← 10.0 ←
 beste Teiler 65.2 (1.) 81.2 (7.) 125.6 (4.)
 Trefferlage 0.92 mm links, 0.10 mm hoch
 Streuwert 1.45, horizontal: 1.75, vertikal: 1.07

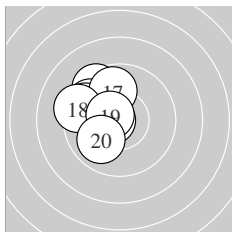

Serie 2:
 9.5 ↘ 10.0 ↘ 10.4 * 9.7 ↘ 10.6 *
 9.6 ← 9.8 ↑ 9.3 ← 10.6 * 10.0 ↙
 beste Teiler 76.0 (15.) 100.1 (19.) 131.7 (13.)
 Trefferlage 1.80 mm links, 1.12 mm hoch
 Streuwert 1.29, horizontal: 1.15, vertikal: 1.41

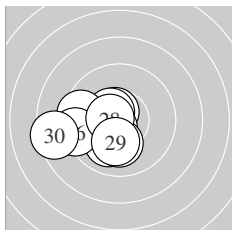

Serie 3:
 10.6 * 10.0 ↙ 10.5 * 9.5 ← 10.6 *
 9.2 ← 10.1 ↓ 10.6 * 10.1 ↓ 8.5 ←
 beste Teiler 90.8 (21.) 91.4 (25.) 91.5 (28.)
 Trefferlage 1.81 mm links, 0.71 mm tief
 Streuwert 1.68, horizontal: 2.05, vertikal: 1.20

Unterschrift des Schützen

Ergebnis: **303.5** (292)
 Serien: 98.2 102.6 102.7
 Zähler: 23 6 1 0 0 0 0 0 0 0
 Innenzehner: 17
 weiteste: 623 (5), 444 (14), 360 (27)
 beste Teiler 45.3 (17.) 79.8 (23.) 82.0 (13.)
 Trefferlage 0.94 mm rechts, 0.41 mm hoch
 Streuwert 1.58, horizontal: 1.64, vertikal: 1.52

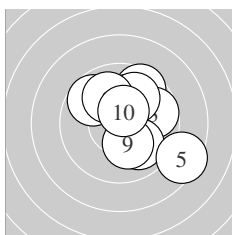
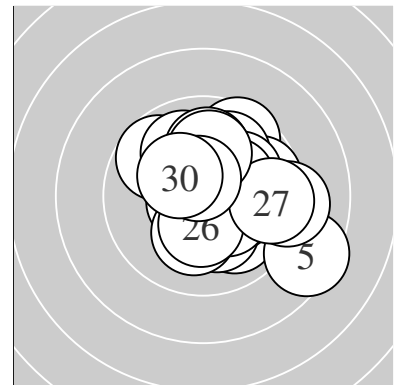

Serie 1:
 9.7 ↘ 9.6 ↗ 9.7 → 10.0 ↘ 8.5 ↘
 10.1 ↑ 9.9 ↗ 10.0 ↘ 10.2 * 10.5 *
 beste Teiler 112.2 (10.) 191.4 (9.) 204.9 (6.)
 Trefferlage 1.13 mm rechts, 0.67 mm hoch
 Streuwert 2.11, horizontal: 2.13, vertikal: 2.10

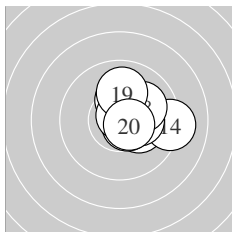

Serie 2:
 10.5 * 10.2 * 10.6 * 9.2 → 10.3 *
 10.3 * 10.8 * 10.1 ↗ 10.0 ↑ 10.6 *
 beste Teiler 45.3 (17.) 82.0 (13.) 91.7 (20.)
 Trefferlage 1.27 mm rechts, 0.43 mm hoch
 Streuwert 1.17, horizontal: 1.29, vertikal: 1.04

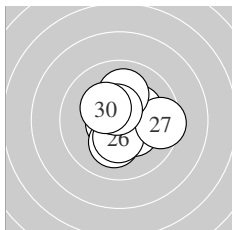

Serie 3:
 10.3 * 10.3 * 10.6 * 10.2 * 10.5 *
 10.4 * 9.5 → 10.0 ↑ 10.6 * 10.3 *
 beste Teiler 79.8 (23.) 95.3 (29.) 119.5 (25.)
 Trefferlage 0.41 mm rechts, 0.13 mm hoch
 Streuwert 1.36, horizontal: 1.40, vertikal: 1.33

Unterschrift des Schützen

Ergebnis: **277.6** (262)
 Serien: 95.1 89.7 92.8
 Zähler: 5 15 8 1 1 0 0 0 0 0
 Innenzehner: 4
 weiteste: 1215 (15), 816 (30), 740 (18)
 beste Teiler 61.5 (9.) 64.1 (6.) 157.9 (2.)
 Trefferlage 0.40 mm links, 0.92 mm hoch
 Streuwert 3.42, horizontal: 4.43, vertikal: 1.95

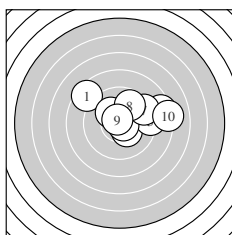
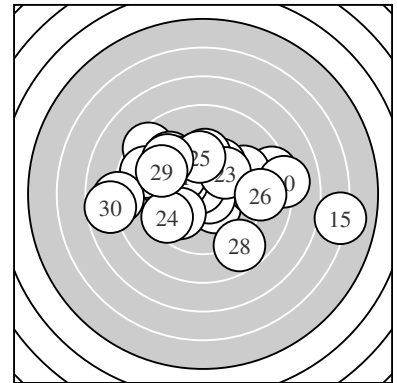

Serie 1:
 8.5 ↘ 10.3 * 8.4 → 10.2 * 9.1 →
 10.7 * 9.3 ↗ 9.8 ↑ 10.7 * 8.1 →
 beste Teiler 61.5 (9.) 64.1 (6.) 157.9 (2.)
 Trefferlage 1.77 mm rechts, 1.24 mm hoch
 Streuwert 2.73, horizontal: 3.57, vertikal: 1.48

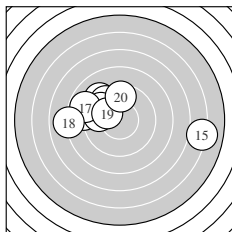

Serie 2:
 9.2 ↘ 8.9 ← 9.6 ↘ 9.7 ↘ 6.1 →
 9.7 ← 8.8 ← 8.0 ← 10.1 ↘ 9.6 ↑
 beste Teiler 205.4 (19.) 305.9 (16.) 325.0 (14.)
 Trefferlage 1.79 mm links, 1.29 mm hoch
 Streuwert 3.92, horizontal: 5.27, vertikal: 1.70

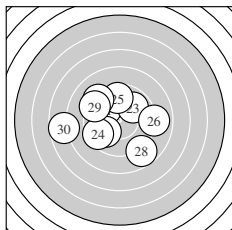

Serie 3:
 9.9 ↘ 9.9 ↙ 9.9 ↗ 9.5 ↙ 9.7 ↑
 8.9 → 9.2 ↘ 8.8 ↘ 9.3 ↘ 7.7 ←
 beste Teiler 252.0 (21.) 263.2 (22.) 265.9 (23.)
 Trefferlage 1.21 mm links, 0.21 mm hoch
 Streuwert 3.22, horizontal: 3.80, vertikal: 2.51

Unterschrift des Schützen

Ergebnis: **294.6** (281)
 Serien: 99.7 99.5 95.4
 Zähler: 12 17 1 0 0 0 0 0 0 0
 Innenzehner: 7
 weiteste: 711 (25), 448 (4), 440 (23)
 beste Teiler 95.4 (20.) 101.0 (9.) 128.8 (5.)
 Trefferlage 1.45 mm rechts, 0.01 mm tief
 Streuwert 1.97, horizontal: 2.08, vertikal: 1.84

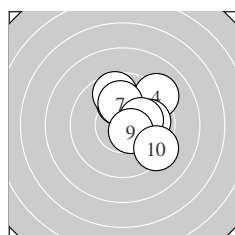
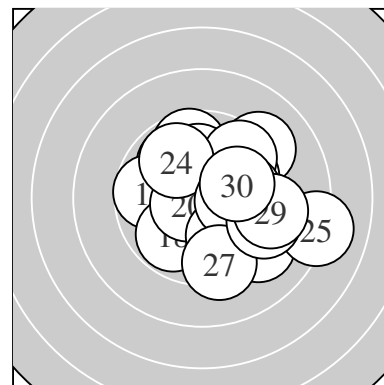

Serie 1:
 10.4 * 10.0 ↑ 9.7 ↑ 9.2 ↗ 10.4 *
 9.9 → 10.1 ↑ 10.2 * 10.5 * 9.3 ↘
 beste Teiler 101.0 (9.) 128.8 (5.) 143.6 (1.)
 Trefferlage 1.32 mm rechts, 0.87 mm hoch
 Streuwert 1.62, horizontal: 1.50, vertikal: 1.73

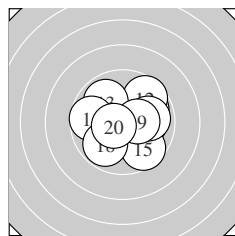

Serie 2:
 9.9 ↗ 9.6 ↗ 9.9 ↘ 10.1 → 9.6 ↘
 9.7 ← 9.9 → 9.8 ↙ 10.4 * 10.6 *
 beste Teiler 95.4 (20.) 149.1 (19.) 218.7 (14.)
 Trefferlage 0.55 mm rechts, 0.12 mm hoch
 Streuwert 1.90, horizontal: 2.15, vertikal: 1.61

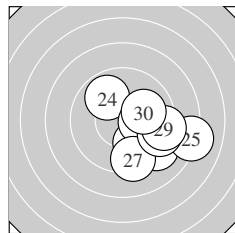

Serie 3:
 10.1 → 9.9 ↘ 9.2 ↘ 9.9 ↘ 8.1 →
 10.2 * 9.3 ↘ 9.4 → 9.3 → 10.0 →
 beste Teiler 180.8 (26.) 222.7 (21.) 227.1 (30.)
 Trefferlage 2.49 mm rechts, 1.03 mm tief
 Streuwert 2.03, horizontal: 2.23, vertikal: 1.81

Unterschrift des Schützen

Meyton Elektronik

Ergebnis: **288.4** (274)
 Serien: 94.3 97.7 96.4
 Zähler: 6 22 2 0 0 0 0 0 0 0
 Innenzehner: 2
 weiteste: 518 (5), 506 (6), 491 (4)
 beste Teiler 172.5 (8.) 185.9 (12.) 211.6 (13.)
 Trefferlage 0.79 mm links, 0.11 mm hoch
 Streuwert 2.42, horizontal: 2.51, vertikal: 2.33

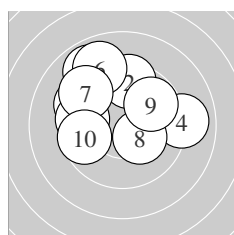
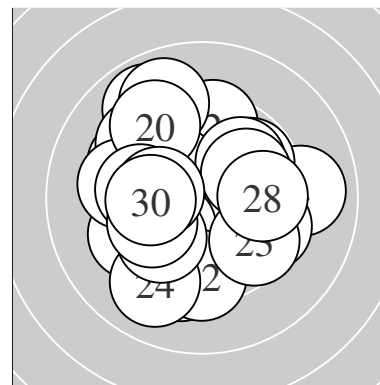

Serie 1:
 9.4 ↘ 9.5 ↑ 9.6 ← 9.0 → 8.9 ↖
 8.9 ↖ 9.3 ↘ 10.3 * 9.8 ↗ 9.6 ←
 beste Teiler 172.5 (8.) 292.4 (9.) 331.1 (10.)
 Trefferlage 0.84 mm links, 1.77 mm hoch
 Streuwert 2.55, horizontal: 2.95, vertikal: 2.07

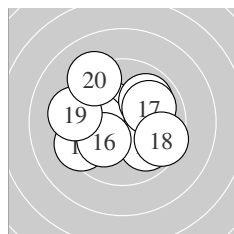

Serie 2:
 9.9 ↘ 10.2 * 10.1 ← 9.9 ↗ 9.4 ↖
 10.1 ↖ 10.0 ↗ 9.6 ↘ 9.3 ← 9.2 ↖
 beste Teiler 185.9 (12.) 211.6 (13.) 212.9 (16.)
 Trefferlage 0.54 mm links, 0.22 mm hoch
 Streuwert 2.25, horizontal: 2.60, vertikal: 1.82

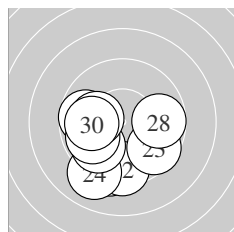

Serie 3:
 9.3 ↓ 9.4 ↓ 9.6 ↘ 9.0 ↖ 9.7 ←
 9.8 ↖ 9.9 ↖ 9.7 → 10.1 ← 9.9 ←
 beste Teiler 215.9 (29.) 256.2 (30.) 275.9 (27.)
 Trefferlage 1.00 mm links, 1.65 mm tief
 Streuwert 2.02, horizontal: 2.19, vertikal: 1.83

Unterschrift des Schützen

Meyton Elektronik

Ergebnis: **308.2** (295)
 Serien: 100.6 103.9 103.7
 Zähler: 25 5 0 0 0 0 0 0 0 0
 Innenzehner: 18
 weiteste: 381 (2), 374 (5), 289 (3)
 beste Teiler 31.0 (16.) 41.6 (29.) 45.6 (11.)
 Trefferlage 0.04 mm rechts, 0.62 mm hoch
 Streuwert 1.32, horizontal: 1.37, vertikal: 1.27

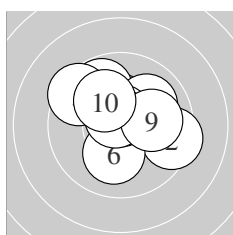
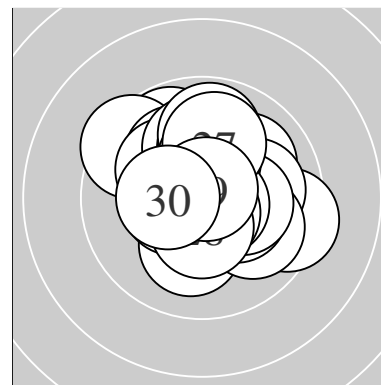

Serie 1:
 10.3 * 9.4 → 9.8 ↖ 10.0 ↗ 9.5 ↘
 10.1 ↓ 10.7 * 10.7 * 10.0 → 10.1 ↖
 beste Teiler 69.0 (7.) 70.4 (8.) 158.4 (1.)
 Trefferlage 0.11 mm rechts, 0.82 mm hoch
 Streuwert 1.72, horizontal: 1.96, vertikal: 1.42

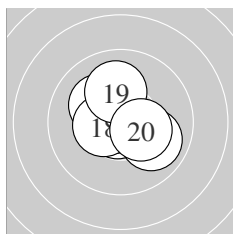

Serie 2:
 10.8 * 10.5 * 10.5 * 10.3 * 10.2 *
 10.8 * 9.9 ↘ 10.5 * 10.1 ↑ 10.3 *
 beste Teiler 31.0 (16.) 45.6 (11.) 105.1 (12.)
 Trefferlage 0.26 mm links, 0.35 mm hoch
 Streuwert 1.12, horizontal: 1.20, vertikal: 1.04

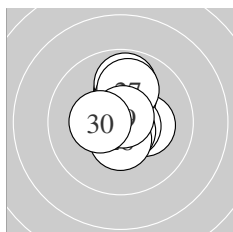

Serie 3:
 10.3 * 10.1 ↑ 9.9 ↑ 10.3 * 10.7 *
 10.7 * 10.0 ↑ 10.5 * 10.8 * 10.4 *
 beste Teiler 41.6 (29.) 69.8 (26.) 73.0 (25.)
 Trefferlage 0.28 mm rechts, 0.68 mm hoch
 Streuwert 1.14, horizontal: 0.78, vertikal: 1.41

Unterschrift des Schützen

Ergebnis: **289.7** (276)
 Serien: 93.4 96.3 100.0
 Zähler: 11 16 1 2 0 0 0 0 0 0
 Innenzehner: 9
 weiteste: 963 (6), 804 (5), 747 (13)
 beste Teiler 58.0 (24.) 75.2 (29.) 87.3 (1.)
 Trefferlage 0.72 mm links, 1.25 mm tief
 Streuwert 2.62, horizontal: 3.29, vertikal: 1.71

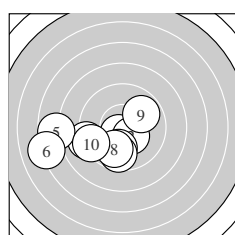
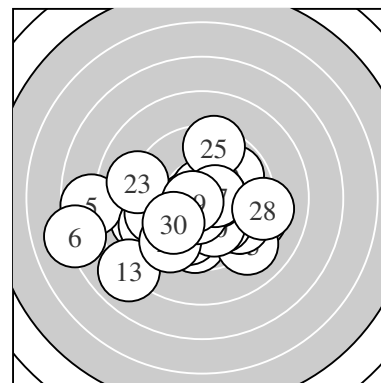

Serie 1:
 10.6 * 10.4 * 9.9 ↓ 9.1 ← 7.7 ←
 7.1 ← 9.7 ↓ 9.8 ↓ 9.9 ↗ 9.2 ←
 beste Teiler 87.3 (1.) 145.6 (2.) 255.5 (3.)
 Trefferlage 2.46 mm links, 1.53 mm tief
 Streuwert 2.87, horizontal: 3.81, vertikal: 1.42

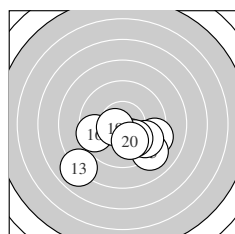

Serie 2:
 9.3 ↘ 9.7 ↘ 8.0 ↙ 10.2 * 9.1 ↘
 9.5 ← 9.7 ↘ 10.1 ↘ 10.6 * 10.1 ↘
 beste Teiler 98.7 (19.) 178.0 (14.) 219.4 (20.)
 Trefferlage 0.59 mm rechts, 2.06 mm tief
 Streuwert 2.32, horizontal: 2.98, vertikal: 1.35

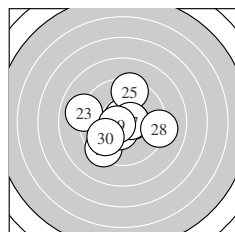

Serie 3:
 10.6 * 9.4 ↙ 9.0 ← 10.7 * 9.4 ↑
 10.5 * 10.6 * 9.2 → 10.7 * 9.9 ↙
 beste Teiler 58.0 (24.) 75.2 (29.) 94.8 (27.)
 Trefferlage 0.28 mm links, 0.15 mm tief
 Streuwert 2.16, horizontal: 2.44, vertikal: 1.84

Unterschrift des Schützen

Meyton Elektronik

Ergebnis: **313.0** (298)
 Serien: 104.5 105.2 103.3
 Zähler: 28 2 0 0 0 0 0 0 0 0
 Innenzehner: 25
 weiteste: 271 (26), 261 (3), 237 (29)
 beste Teiler 29.8 (28.) 50.1 (18.) 52.7 (9.)
 Trefferlage 0.23 mm links, 0.25 mm hoch
 Streuwert 1.01, horizontal: 0.87, vertikal: 1.13

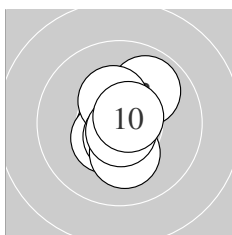
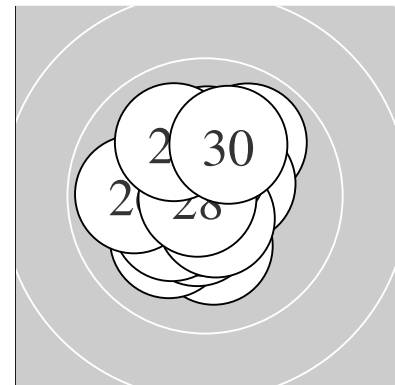

Serie 1:
 10.4 * 10.5 * 9.9 ↗ 10.7 * 10.4 *
 10.4 * 10.6 * 10.2 * 10.7 * 10.7 *
 beste Teiler 52.7 (9.) 59.5 (4.) 68.0 (10.)
 Trefferlage 0.16 mm rechts, 0.16 mm hoch
 Streuwert 1.02, horizontal: 0.70, vertikal: 1.26

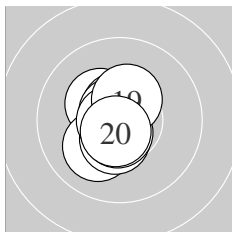

Serie 2:
 10.5 * 10.3 * 10.6 * 10.7 * 10.1 ↘
 10.5 * 10.6 * 10.8 * 10.4 * 10.7 *
 beste Teiler 50.1 (18.) 61.0 (14.) 75.2 (20.)
 Trefferlage 0.46 mm links, 0.00 mm
 Streuwert 0.82, horizontal: 0.55, vertikal: 1.03

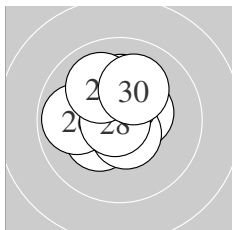

Serie 3:
 10.4 * 10.3 * 10.5 * 10.6 * 10.5 *
 9.9 ← 10.2 * 10.8 * 10.0 ↘ 10.1 ↗
 beste Teiler 29.8 (28.) 95.2 (24.) 107.4 (25.)
 Trefferlage 0.38 mm links, 0.60 mm hoch
 Streuwert 1.15, horizontal: 1.18, vertikal: 1.12

Unterschrift des Schützen

Ergebnis: **306.8** (296)
 Serien: 103.4 101.3 102.1
 Zähler: 27 2 1 0 0 0 0 0 0 0
 Innenzehner: 19
 weiteste: 632 (14), 292 (13), 287 (27)
 beste Teiler 53.8 (22.) 68.4 (19.) 75.1 (18.)
 Trefferlage 0.51 mm links, 0.06 mm tief
 Streuwert 1.46, horizontal: 1.39, vertikal: 1.52

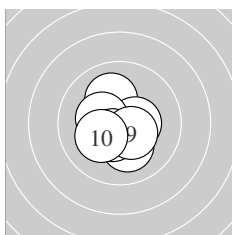
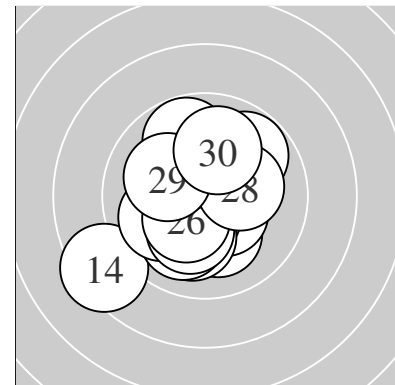

Serie 1:
 10.1 ↗ 10.4 * 10.4 * 10.4 * 10.1 ↘
 10.6 * 10.3 * 10.5 * 10.4 * 10.2 *
 beste Teiler 88.4 (6.) 118.3 (8.) 129.1 (9.)
 Trefferlage 0.25 mm links, 0.40 mm tief
 Streuwert 1.09, horizontal: 1.12, vertikal: 1.07

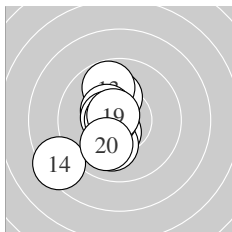

Serie 2:
 10.5 * 10.2 * 9.8 ↗ 8.4 ↙ 10.1 ↘
 10.4 * 10.5 * 10.7 * 10.7 * 10.0 ↙
 beste Teiler 68.4 (19.) 75.1 (18.) 110.4 (11.)
 Trefferlage 1.20 mm links, 0.26 mm tief
 Streuwert 1.71, horizontal: 1.42, vertikal: 1.96

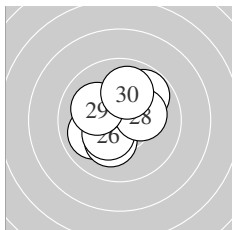

Serie 3:
 10.1 ↗ 10.7 * 10.0 ↙ 10.6 * 10.2 *
 10.4 * 9.8 ↗ 10.2 * 10.1 ↘ 10.0 ↗
 beste Teiler 53.8 (22.) 88.1 (24.) 149.8 (26.)
 Trefferlage 0.08 mm links, 0.46 mm hoch
 Streuwert 1.44, horizontal: 1.47, vertikal: 1.42

Unterschrift des Schützen

Ergebnis: **307.6** (294)
 Serien: 99.9 103.9 103.8
 Zähler: 24 6 0 0 0 0 0 0 0 0
 Innenzehner: 18
 weiteste: 471 (7), 393 (4), 274 (5)
 beste Teiler 62.8 (17.) 66.6 (10.) 72.1 (15.)
 Trefferlage 0.28 mm rechts, 0.34 mm tief
 Streuwert 1.42, horizontal: 1.70, vertikal: 1.08

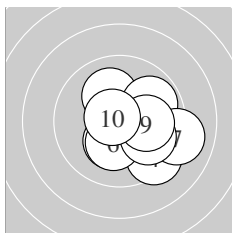
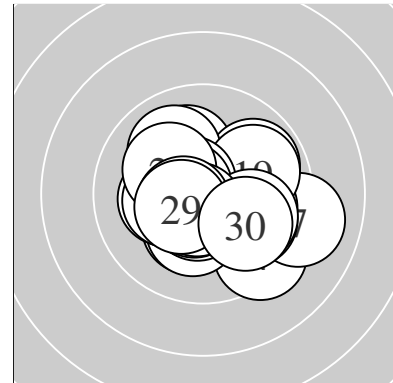

Serie 1:
 10.3 * 10.1 ↖ 10.1 → 9.4 ↘ 9.9 ↗
 10.3 * 9.1 → 9.9 ↘ 10.1 → 10.7 *
 beste Teiler 66.6 (10.) 172.0 (1.) 175.9 (6.)
 Trefferlage 1.36 mm rechts, 0.57 mm tief
 Streuwert 1.68, horizontal: 1.86, vertikal: 1.47

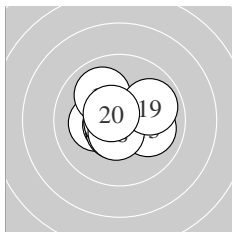

Serie 2:
 10.2 * 10.0 ↖ 10.0 → 10.6 * 10.7 *
 10.6 * 10.7 * 10.6 * 9.9 ↗ 10.6 *
 beste Teiler 62.8 (17.) 72.1 (15.) 78.7 (14.)
 Trefferlage 0.17 mm links, 0.01 mm tief
 Streuwert 1.19, horizontal: 1.40, vertikal: 0.94

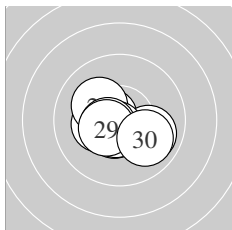

Serie 3:
 10.6 * 10.6 * 9.9 ↘ 10.3 * 10.2 *
 10.6 * 10.6 * 10.5 * 10.5 * 10.0 ↘
 beste Teiler 79.4 (27.) 88.2 (21.) 90.3 (26.)
 Trefferlage 0.33 mm links, 0.42 mm tief
 Streuwert 1.11, horizontal: 1.39, vertikal: 0.73

Unterschrift des Schützen

Ergebnis: **304.3** (296)
 Serien: 101.9 100.5 101.9
 Zähler: 26 4 0 0 0 0 0 0 0 0
 Innenzehner: 17
 weiteste: 329 (19), 306 (14), 288 (25)
 beste Teiler 129.2 (12.) 141.9 (28.) 145.5 (9.)
 Trefferlage 0.37 mm rechts, 0.20 mm tief
 Streuwert 1.46, horizontal: 1.90, vertikal: 0.79

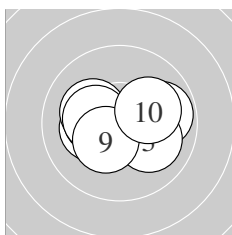
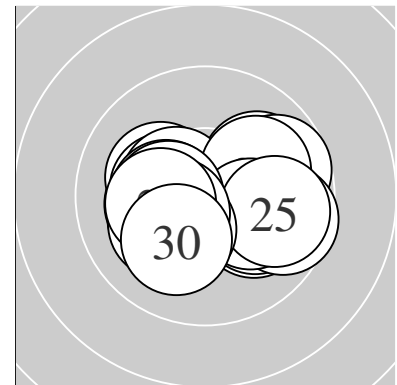

Serie 1:
 10.2 * 9.8 → 10.1 ↘ 10.3 * 10.2 *
 10.2 * 10.3 * 10.3 * 10.4 * 10.1 →
 beste Teiler 145.5 (9.) 152.8 (4.) 154.9 (7.)
 Trefferlage 0.06 mm links, 0.01 mm tief
 Streuwert 1.44, horizontal: 1.90, vertikal: 0.73

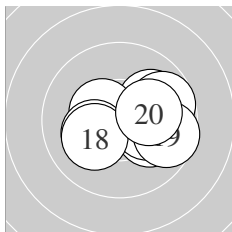

Serie 2:
 10.0 ↗ 10.4 * 10.1 → 9.7 → 10.1 ↘
 10.2 * 10.2 * 10.1 ↙ 9.6 → 10.1 →
 beste Teiler 129.2 (12.) 190.3 (17.) 191.8 (16.)
 Trefferlage 1.15 mm rechts, 0.14 mm tief
 Streuwert 1.48, horizontal: 1.90, vertikal: 0.88

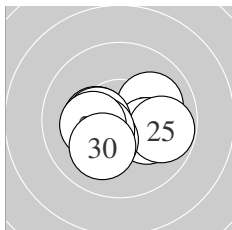

Serie 3:
 10.3 * 10.2 * 10.0 ↗ 10.2 * 9.8 →
 10.4 * 10.3 * 10.4 * 10.2 * 10.1 ↙
 beste Teiler 141.9 (28.) 149.0 (26.) 159.0 (21.)
 Trefferlage 0.03 mm rechts, 0.44 mm tief
 Streuwert 1.42, horizontal: 1.85, vertikal: 0.78

Unterschrift des Schützen

Ergebnis: **311.5** (295)
 Serien: 105.5 101.6 104.4
 Zähler: 26 3 1 0 0 0 0 0 0 0
 Innenzehner: 24
 weiteste: 511 (14), 328 (24), 282 (15)
 beste Teiler 13.0 (5.) 40.3 (26.) 48.3 (17.)
 Trefferlage 0.00 mm , 0.03 mm hoch
 Streuwert 1.25, horizontal: 1.54, vertikal: 0.87

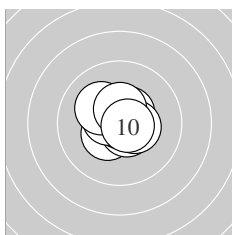
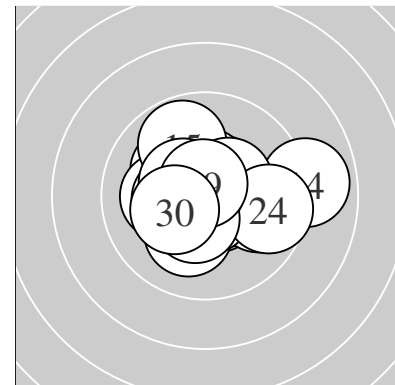

Serie 1:
 10.4 * 10.7 * 10.6 * 10.5 * 10.9 *
 10.4 * 10.6 * 10.2 * 10.5 * 10.7 *
 beste Teiler 13.0 (5.) 71.1 (10.) 73.3 (2.)
 Trefferlage 0.03 mm rechts, 0.23 mm hoch
 Streuwert 0.83, horizontal: 0.90, vertikal: 0.75

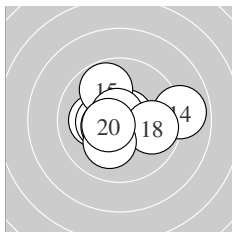

Serie 2:
 10.7 * 10.1 ← 10.4 * 8.9 → 9.8 ↗
 10.5 * 10.8 * 9.8 → 10.1 ↓ 10.5 *
 beste Teiler 48.3 (17.) 65.0 (11.) 102.9 (20.)
 Trefferlage 0.06 mm rechts, 0.04 mm hoch
 Streuwert 1.75, horizontal: 2.21, vertikal: 1.13

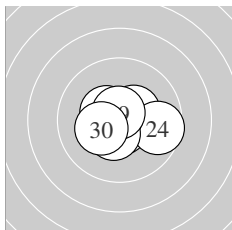

Serie 3:
 10.4 * 10.7 * 10.5 * 9.6 → 10.5 *
 10.8 * 10.5 * 10.4 * 10.7 * 10.3 *
 beste Teiler 40.3 (26.) 62.8 (29.) 70.0 (22.)
 Trefferlage 0.08 mm links, 0.18 mm tief
 Streuwert 1.10, horizontal: 1.40, vertikal: 0.70

Unterschrift des Schützen

Ergebnis: **309.0** (295)
 Serien: 103.4 102.0 103.6
 Zähler: 25 5 0 0 0 0 0 0 0 0
 Innenzehner: 21
 weiteste: 366 (18), 280 (4), 275 (21)
 beste Teiler 31.7 (8.) 53.4 (27.) 66.2 (24.)
 Trefferlage 0.02 mm links, 0.00 mm
 Streuwert 1.30, horizontal: 1.42, vertikal: 1.17

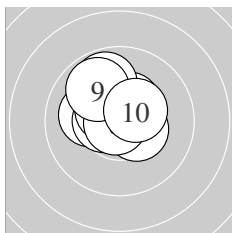
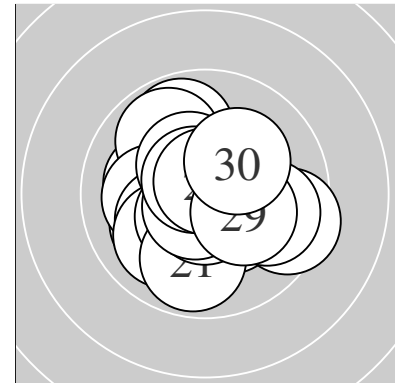

Serie 1:
 10.4 * 10.6 * 10.1 ← 9.8 ↑ 10.5 *
 10.5 * 10.4 * 10.8 * 9.9 ↗ 10.4 *
 beste Teiler 31.7 (8.) 86.4 (2.) 109.0 (5.)
 Trefferlage 0.45 mm links, 0.79 mm hoch
 Streuwert 1.06, horizontal: 1.11, vertikal: 1.00

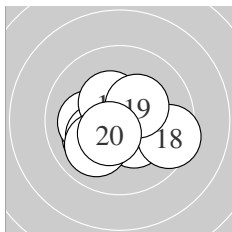

Serie 2:
 10.6 * 10.1 ↙ 10.3 * 10.1 ← 10.2 *
 10.4 * 10.0 ↙ 9.5 → 10.3 * 10.5 *
 beste Teiler 89.0 (11.) 119.2 (20.) 138.7 (16.)
 Trefferlage 0.34 mm links, 0.47 mm tief
 Streuwert 1.44, horizontal: 1.75, vertikal: 1.04

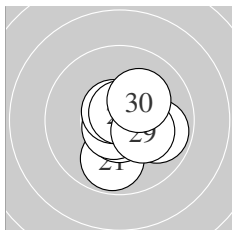

Serie 3:
 9.9 ↓ 10.7 * 10.4 * 10.7 * 10.2 *
 10.7 * 10.7 * 9.9 → 10.2 * 10.2 *
 beste Teiler 53.4 (27.) 66.2 (24.) 74.0 (22.)
 Trefferlage 0.73 mm rechts, 0.33 mm tief
 Streuwert 1.12, horizontal: 1.12, vertikal: 1.12

Unterschrift des Schützen

Ergebnis: **305.0** (290)
 Serien: 99.9 103.2 101.9
 Zähler: 20 10 0 0 0 0 0 0 0 0
 Innenzehner: 16
 weiteste: 381 (1), 342 (7), 313 (13)
 beste Teiler 18.0 (11.) 56.6 (15.) 58.0 (17.)
 Trefferlage 0.27 mm links, 0.24 mm hoch
 Streuwert 1.53, horizontal: 1.77, vertikal: 1.24

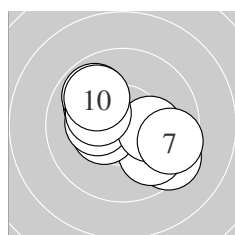
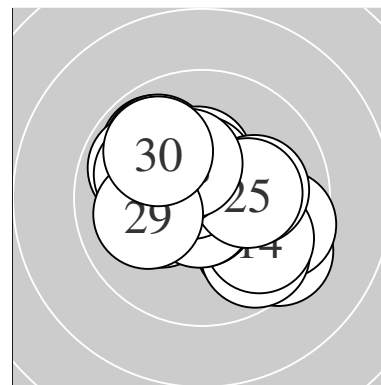

Serie 1:
 9.4 ↘ 9.9 ↘ 10.1 ↖ 10.4 * 10.3 *
 10.2 * 9.6 → 9.9 ↖ 10.2 * 9.9 ↖
 beste Teiler 132.1 (4.) 170.7 (5.) 185.5 (9.)
 Trefferlage 0.01 mm rechts, 0.02 mm hoch
 Streuwert 1.89, horizontal: 2.23, vertikal: 1.47

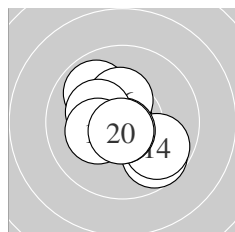

Serie 2:
 10.9 * 9.9 ↖ 9.7 ↘ 9.8 ↘ 10.7 *
 10.4 * 10.7 * 10.2 * 10.2 * 10.7 *
 beste Teiler 18.0 (11.) 56.6 (15.) 58.0 (17.)
 Trefferlage 0.15 mm links, 0.12 mm tief
 Streuwert 1.39, horizontal: 1.46, vertikal: 1.31

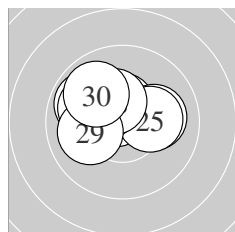

Serie 3:
 10.5 * 9.9 ↖ 10.1 → 10.7 * 10.2 *
 10.3 * 10.0 ↖ 10.3 * 10.0 ← 9.9 ↖
 beste Teiler 74.4 (24.) 112.1 (21.) 152.8 (28.)
 Trefferlage 0.68 mm links, 0.81 mm hoch
 Streuwert 1.27, horizontal: 1.64, vertikal: 0.73

Unterschrift des Schützen

Meyton Elektronik

Ergebnis: **310.8** (296)
 Serien: 103.2 105.0 102.6
 Zähler: 26 4 0 0 0 0 0 0 0 0
 Innenzehner: 23
 weiteste: 412 (27), 288 (20), 274 (2)
 beste Teiler 13.4 (16.) 51.6 (13.) 52.2 (3.)
 Trefferlage 0.35 mm links, 0.23 mm tief
 Streuwert 1.19, horizontal: 1.30, vertikal: 1.06

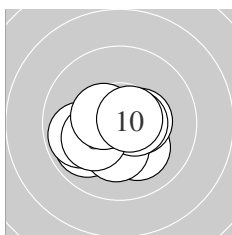
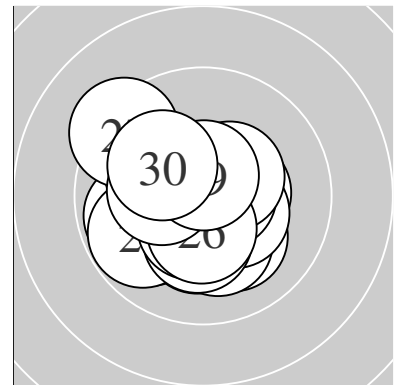

Serie 1:
 9.9 ↙ 9.9 ← 10.7 * 10.1 ↘ 10.3 *
 10.4 * 10.5 * 10.2 * 10.5 * 10.7 *
 beste Teiler 52.2 (3.) 73.5 (10.) 103.0 (7.)
 Trefferlage 0.41 mm links, 0.57 mm tief
 Streuwert 1.20, horizontal: 1.47, vertikal: 0.84

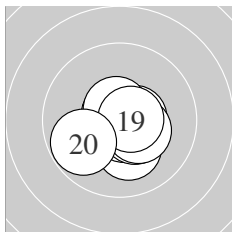

Serie 2:
 10.2 * 10.7 * 10.7 * 10.4 * 10.6 *
 10.9 * 10.4 * 10.7 * 10.6 * 9.8 ↙
 beste Teiler 13.4 (16.) 51.6 (13.) 70.2 (12.)
 Trefferlage 0.18 mm rechts, 0.40 mm tief
 Streuwert 0.96, horizontal: 1.09, vertikal: 0.83

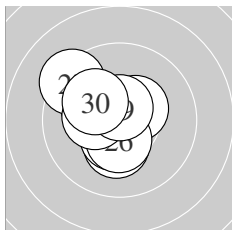

Serie 3:
 10.3 * 10.4 * 10.1 ↖ 10.4 * 10.7 *
 10.4 * 9.3 ↖ 10.3 * 10.6 * 10.1 ↖
 beste Teiler 58.0 (25.) 84.0 (29.) 126.2 (22.)
 Trefferlage 0.82 mm links, 0.29 mm hoch
 Streuwert 1.29, horizontal: 1.24, vertikal: 1.33

Unterschrift des Schützen

Ergebnis: **310.9** (299)
 Serien: 103.1 103.1 104.7
 Zähler: 29 1 0 0 0 0 0 0 0 0
 Innenzehner: 25
 weiteste: 264 (19), 241 (17), 238 (29)
 beste Teiler 54.1 (24.) 60.7 (23.) 64.2 (26.)
 Trefferlage 0.30 mm rechts, 0.18 mm hoch
 Streuwert 1.09, horizontal: 1.05, vertikal: 1.12

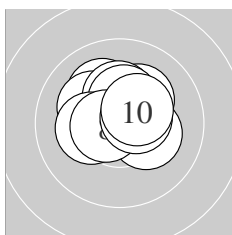
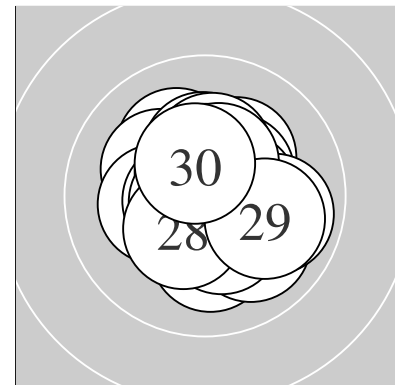

Serie 1:
 10.1 ↖ 10.2 * 10.2 * 10.2 * 10.3 *
 10.4 * 10.2 * 10.6 * 10.5 * 10.4 *
 beste Teiler 85.9 (8.) 108.7 (9.) 137.6 (10.)
 Trefferlage 0.02 mm links, 0.72 mm hoch
 Streuwert 1.08, horizontal: 1.25, vertikal: 0.87

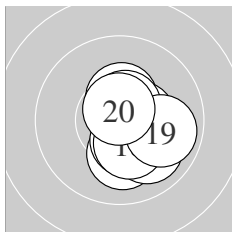

Serie 2:
 10.4 * 10.2 * 10.5 * 10.1 ↓ 10.6 *
 10.4 * 10.0 ↘ 10.3 * 9.9 → 10.7 *
 beste Teiler 69.1 (20.) 91.9 (15.) 123.1 (13.)
 Trefferlage 0.85 mm rechts, 0.51 mm tief
 Streuwert 1.03, horizontal: 0.85, vertikal: 1.19

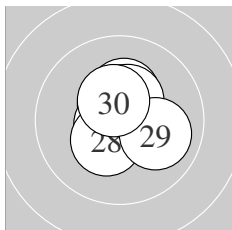

Serie 3:
 10.3 * 10.5 * 10.7 * 10.7 * 10.6 *
 10.7 * 10.4 * 10.4 * 10.0 → 10.4 *
 beste Teiler 54.1 (24.) 60.7 (23.) 64.2 (26.)
 Trefferlage 0.08 mm rechts, 0.34 mm hoch
 Streuwert 0.94, horizontal: 0.89, vertikal: 1.00

Unterschrift des Schützen

Ergebnis: **308.4** (297)
 Serien: 103.1 102.7 102.6
 Zähler: 27 3 0 0 0 0 0 0 0 0
 Innenzehner: 20
 weiteste: 347 (30), 303 (16), 268 (20)
 beste Teiler 49.8 (11.) 53.9 (6.) 54.5 (2.)
 Trefferlage 0.71 mm rechts, 1.00 mm tief
 Streuwert 0.99, horizontal: 0.98, vertikal: 1.00

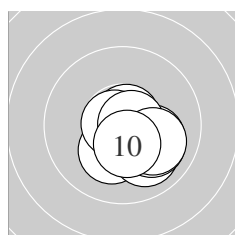
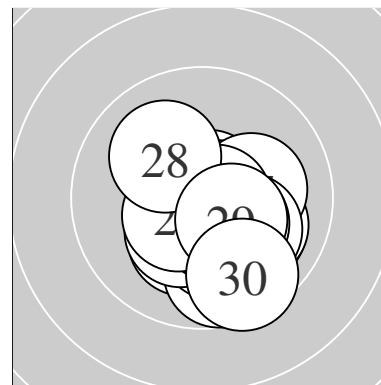

Serie 1:
 10.2 * 10.7 * 10.1 ↘ 10.0 ↘ 10.3 *
 10.7 * 10.7 * 10.0 ↘ 10.0 ↘ 10.4 *
 beste Teiler 53.9 (6.) 54.5 (2.) 58.4 (7.)
 Trefferlage 0.85 mm rechts, 0.84 mm tief
 Streuwert 0.91, horizontal: 1.02, vertikal: 0.79

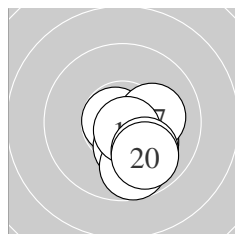

Serie 2:
 10.8 * 10.2 * 10.3 * 10.2 * 10.7 *
 9.7 ↓ 10.2 * 10.7 * 10.0 ↘ 9.9 ↘
 beste Teiler 49.8 (11.) 61.7 (18.) 71.0 (15.)
 Trefferlage 0.88 mm rechts, 1.20 mm tief
 Streuwert 0.91, horizontal: 0.77, vertikal: 1.04

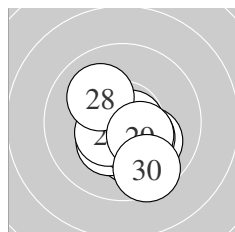

Serie 3:
 10.7 * 10.2 * 10.3 * 10.4 * 10.1 ↘
 10.3 * 10.5 * 10.1 ↘ 10.4 * 9.6 ↘
 beste Teiler 55.1 (21.) 118.8 (27.) 127.0 (24.)
 Trefferlage 0.41 mm rechts, 0.97 mm tief
 Streuwert 1.18, horizontal: 1.14, vertikal: 1.21

Unterschrift des Schützen

Ergebnis: **303.1** (292)
 Serien: 101.5 100.1 101.5
 Zähler: 22 8 0 0 0 0 0 0 0 0
 Innenzehner: 13
 weiteste: 384 (13), 379 (19), 355 (16)
 beste Teiler 7.6 (29.) 69.0 (20.) 73.5 (14.)
 Trefferlage 0.21 mm rechts, 0.77 mm tief
 Streuwert 1.57, horizontal: 1.74, vertikal: 1.38

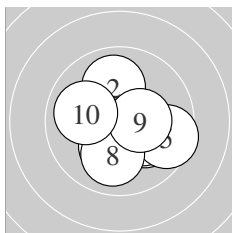
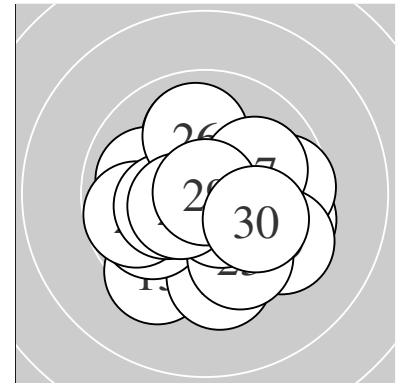

Serie 1:
 10.1 ↘ 10.0 ↑ 10.4 * 10.2 * 9.6 →
 10.6 * 10.2 * 10.0 ↓ 10.4 * 10.0 ←
 beste Teiler 99.3 (6.) 131.0 (3.) 144.0 (9.)
 Trefferlage 0.46 mm rechts, 0.53 mm tief
 Streuwert 1.51, horizontal: 1.68, vertikal: 1.32

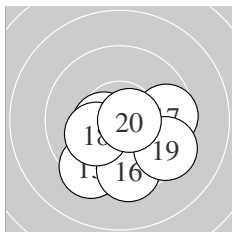

Serie 2:
 10.0 ↙ 10.5 * 9.4 ↗ 10.7 * 10.1 ↘
 9.5 ↓ 9.6 → 10.2 * 9.4 ↘ 10.7 *
 beste Teiler 69.0 (20.) 73.5 (14.) 114.0 (12.)
 Trefferlage 0.36 mm rechts, 1.36 mm tief
 Streuwert 1.64, horizontal: 1.88, vertikal: 1.37

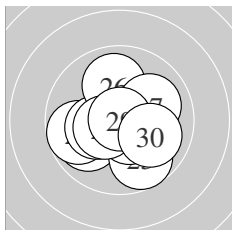

Serie 3:
 9.9 ↙ 9.7 ← 9.7 ↘ 10.3 * 10.5 *
 10.0 ↑ 10.0 → 10.5 * 10.9 * 10.0 ↘
 beste Teiler 7.6 (29.) 111.8 (25.) 115.8 (28.)
 Trefferlage 0.17 mm links, 0.43 mm tief
 Streuwert 1.60, horizontal: 1.78, vertikal: 1.38

Unterschrift des Schützen

Ergebnis: **304.0** (288)
 Serien: 101.8 100.2 102.0
 Zähler: 19 10 1 0 0 0 0 0 0 0
 Innenzehner: 13
 weiteste: 536 (11), 325 (15), 320 (25)
 beste Teiler 55.0 (12.) 70.5 (7.) 90.5 (10.)
 Trefferlage 0.67 mm links, 0.61 mm tief
 Streuwert 1.51, horizontal: 1.67, vertikal: 1.35

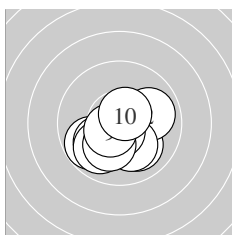
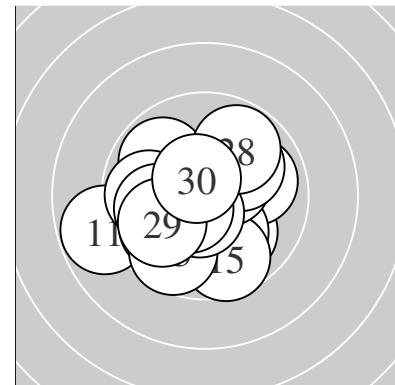

Serie 1:
 10.0 ↘ 9.9 → 9.8 ↙ 10.0 ↗ 10.1 ↓
 9.9 ↗ 10.7 * 10.2 * 10.6 * 10.6 *
 beste Teiler 70.5 (7.) 90.5 (10.) 99.0 (9.)
 Trefferlage 0.21 mm links, 1.05 mm tief
 Streuwert 1.33, horizontal: 1.54, vertikal: 1.07

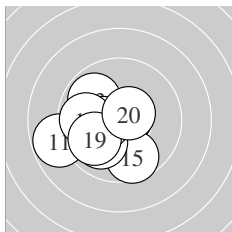

Serie 2:
 8.8 ← 10.7 * 9.9 ↖ 10.4 * 9.7 ↓
 10.0 ↗ 10.4 * 9.8 ← 9.9 ↙ 10.6 *
 beste Teiler 55.0 (12.) 96.4 (20.) 129.0 (14.)
 Trefferlage 1.39 mm links, 0.63 mm tief
 Streuwert 1.65, horizontal: 1.86, vertikal: 1.41

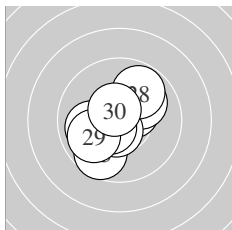

Serie 3:
 10.4 * 10.0 ← 10.5 * 10.0 ↗ 9.7 ↓
 10.6 * 10.5 * 9.8 ↗ 9.9 ↙ 10.6 *
 beste Teiler 91.0 (26.) 97.9 (30.) 101.6 (23.)
 Trefferlage 0.39 mm links, 0.14 mm tief
 Streuwert 1.49, horizontal: 1.48, vertikal: 1.50

Unterschrift des Schützen

Ergebnis: **305.6** (293)
 Serien: 101.9 102.3 101.4
 Zähler: 24 5 1 0 0 0 0 0 0 0
 Innenzehner: 18
 weiteste: 516 (2), 472 (17), 444 (7)
 beste Teiler 37.3 (19.) 37.3 (26.) 38.5 (10.)
 Trefferlage 0.37 mm rechts, 0.06 mm tief
 Streuwert 1.65, horizontal: 1.88, vertikal: 1.38

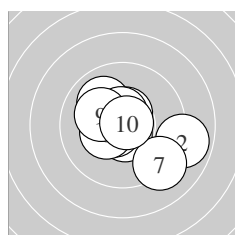
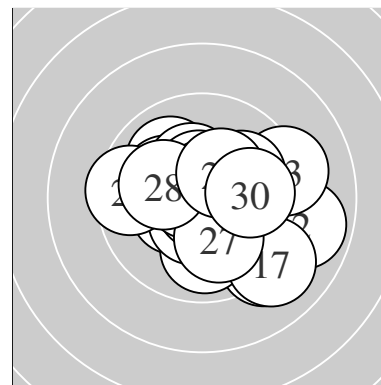

Serie 1:
 10.6 * 8.9 → 10.0 ↖ 10.6 * 10.6 *
 10.4 * 9.2 ↘ 10.6 * 10.2 * 10.8 *
 beste Teiler 38.5 (10.) 82.1 (5.) 84.8 (1.)
 Trefferlage 0.33 mm rechts, 0.15 mm tief
 Streuwert 1.84, horizontal: 2.15, vertikal: 1.45

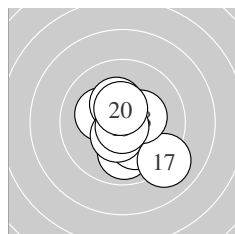

Serie 2:
 10.2 * 10.3 * 10.6 * 9.9 ↓ 10.1 ↘
 10.5 * 9.1 ↘ 10.3 * 10.8 * 10.5 *
 beste Teiler 37.3 (19.) 90.7 (13.) 115.1 (20.)
 Trefferlage 0.33 mm rechts, 0.42 mm tief
 Streuwert 1.53, horizontal: 1.41, vertikal: 1.64

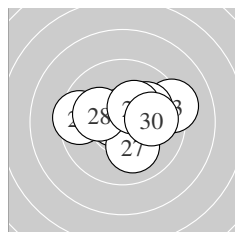

Serie 3:
 10.7 * 10.7 * 9.2 → 9.5 ← 10.0 ↗
 10.8 * 10.1 ↘ 10.1 ← 10.3 * 10.0 →
 beste Teiler 37.3 (26.) 66.7 (21.) 68.6 (22.)
 Trefferlage 0.45 mm rechts, 0.38 mm hoch
 Streuwert 1.69, horizontal: 2.19, vertikal: 0.96

Unterschrift des Schützen

Meyton Elektronik

Ergebnis: **309.9** (296)
 Serien: 104.3 102.8 102.8
 Zähler: 26 4 0 0 0 0 0 0 0 0
 Innenzehner: 21
 weiteste: 294 (19), 279 (1), 279 (23)
 beste Teiler 15.5 (26.) 46.1 (3.) 50.8 (13.)
 Trefferlage 0.36 mm rechts, 0.13 mm hoch
 Streuwert 1.21, horizontal: 1.23, vertikal: 1.19

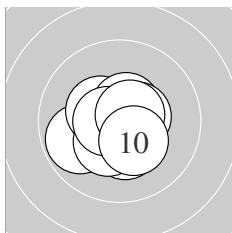
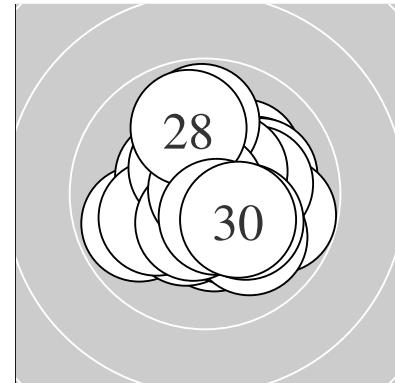

Serie 1:
 9.8 ↙ 10.3 * 10.8 * 10.4 * 10.6 *
 10.4 * 10.5 * 10.6 * 10.6 * 10.3 *
 beste Teiler 46.1 (3.) 78.0 (8.) 78.5 (9.)
 Trefferlage 0.23 mm links, 0.29 mm tief
 Streuwert 1.03, horizontal: 1.14, vertikal: 0.92

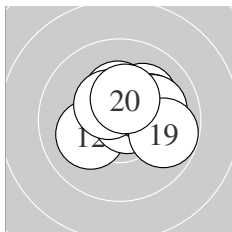

Serie 2:
 10.6 * 10.1 ↙ 10.8 * 10.3 * 10.1 ↗
 10.5 * 10.1 → 10.1 → 9.8 → 10.4 *
 beste Teiler 50.8 (13.) 96.0 (11.) 123.2 (16.)
 Trefferlage 0.64 mm rechts, 0.61 mm hoch
 Streuwert 1.19, horizontal: 1.44, vertikal: 0.89

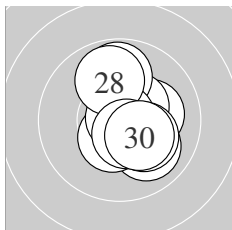

Serie 3:
 10.2 * 10.4 * 9.8 ↑ 10.0 ↘ 10.5 *
 10.9 * 10.2 * 9.9 ↑ 10.6 * 10.3 *
 beste Teiler 15.5 (26.) 99.7 (29.) 121.0 (25.)
 Trefferlage 0.67 mm rechts, 0.10 mm hoch
 Streuwert 1.30, horizontal: 0.95, vertikal: 1.57

Unterschrift des Schützen

Ergebnis: **304.2** (292)
 Serien: 101.2 102.1 100.9
 Zähler: 22 8 0 0 0 0 0 0 0 0
 Innenzehner: 14
 weiteste: 342 (10), 330 (25), 324 (11)
 beste Teiler 34.5 (14.) 78.2 (1.) 82.5 (20.)
 Trefferlage 0.10 mm rechts, 0.43 mm tief
 Streuwert 1.52, horizontal: 1.40, vertikal: 1.64

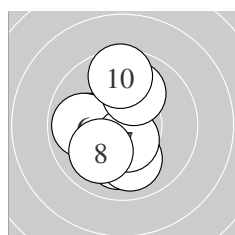
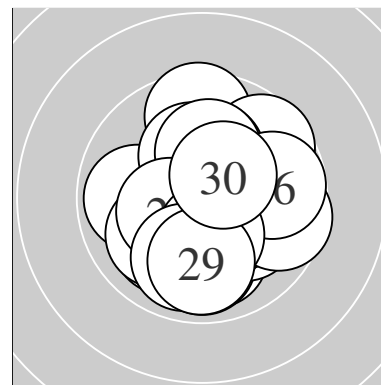

Serie 1:
 10.6 * 10.5 * 10.0 ← 10.1 ↓ 10.0 ↓
 9.9 ← 10.5 * 10.0 ↗ 10.0 ↑ 9.6 ↑
 beste Teiler 78.2 (1.) 106.0 (2.) 107.5 (7.)
 Trefferlage 0.70 mm links, 0.22 mm tief
 Streuwert 1.56, horizontal: 1.19, vertikal: 1.86

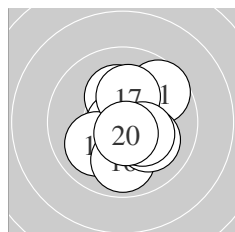

Serie 2:
 9.7 ↗ 10.2 * 10.3 * 10.8 * 10.0 ↗
 9.9 ↓ 10.2 * 10.1 ↘ 10.3 * 10.6 *
 beste Teiler 34.5 (14.) 82.5 (20.) 161.8 (19.)
 Trefferlage 0.50 mm rechts, 0.26 mm tief
 Streuwert 1.44, horizontal: 1.25, vertikal: 1.61

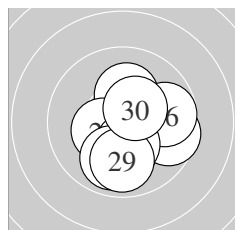

Serie 3:
 10.1 ↓ 10.3 * 10.2 * 10.4 * 9.6 →
 9.8 → 10.3 * 9.9 ↓ 9.9 ↓ 10.4 *
 beste Teiler 130.2 (30.) 146.5 (24.) 159.1 (27.)
 Trefferlage 0.52 mm rechts, 0.82 mm tief
 Streuwert 1.51, horizontal: 1.49, vertikal: 1.53

Unterschrift des Schützen

Meyton Elektronik

Ergebnis: **305.9** (292)
 Serien: 101.8 101.9 102.2
 Zähler: 22 8 0 0 0 0 0 0 0 0
 Innenzehner: 17
 weiteste: 420 (29), 387 (20), 380 (6)
 beste Teiler 50.0 (17.) 64.0 (26.) 68.2 (11.)
 Trefferlage 0.12 mm links, 0.39 mm hoch
 Streuwert 1.54, horizontal: 1.87, vertikal: 1.12

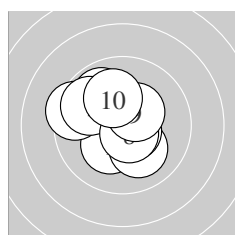
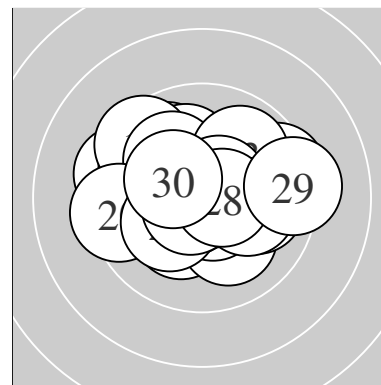

Serie 1:
 10.2 * 10.7 * 10.1 ↘ 9.9 ↖ 10.6 *
 9.4 ← 9.8 ↖ 10.6 * 10.4 * 10.1 ↖
 beste Teiler 74.6 (2.) 80.4 (8.) 85.2 (5.)
 Trefferlage 0.54 mm links, 0.30 mm hoch
 Streuwert 1.54, horizontal: 1.64, vertikal: 1.43

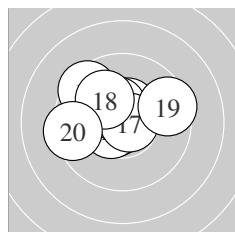

Serie 2:
 10.7 * 10.5 * 9.5 ↖ 10.5 * 10.5 *
 10.4 * 10.8 * 10.1 ↖ 9.5 → 9.4 ←
 beste Teiler 50.0 (17.) 68.2 (11.) 102.6 (14.)
 Trefferlage 0.60 mm links, 0.69 mm hoch
 Streuwert 1.56, horizontal: 1.94, vertikal: 1.05

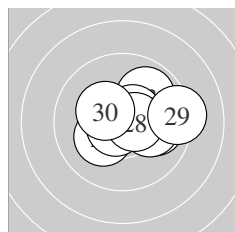

Serie 3:
 10.5 * 10.0 → 9.9 ↗ 10.6 * 10.2 *
 10.7 * 10.1 → 10.6 * 9.3 → 10.3 *
 beste Teiler 64.0 (26.) 92.0 (28.) 98.2 (24.)
 Trefferlage 0.77 mm rechts, 0.17 mm hoch
 Streuwert 1.46, horizontal: 1.88, vertikal: 0.86

Unterschrift des Schützen

Meyton Elektronik

Ergebnis: **302.7** (291)
 Serien: 100.3 101.8 100.6
 Zähler: 21 9 0 0 0 0 0 0 0 0
 Innenzehner: 13
 weiteste: 385 (27), 347 (8), 331 (24)
 beste Teiler 55.2 (14.) 78.8 (15.) 79.4 (18.)
 Trefferlage 0.44 mm links, 0.60 mm hoch
 Streuwert 1.56, horizontal: 1.57, vertikal: 1.56

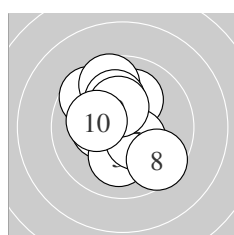
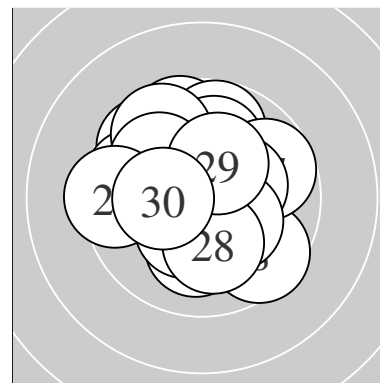

Serie 1:
 10.1 ↑ 9.6 ↘ 9.6 ↗ 10.3 * 10.1 ↓
 10.1 ↗ 10.4 * 9.6 ↘ 10.3 * 10.2 *
 beste Teiler 129.4 (7.) 153.1 (9.) 154.2 (4.)
 Trefferlage 0.37 mm links, 0.58 mm hoch
 Streuwert 1.71, horizontal: 1.48, vertikal: 1.91

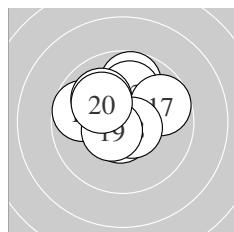

Serie 2:
 9.7 ↖ 9.8 ↑ 10.0 ↑ 10.7 * 10.6 *
 10.0 ↘ 9.7 → 10.6 * 10.6 * 10.1 ↘
 beste Teiler 55.2 (14.) 78.8 (15.) 79.4 (18.)
 Trefferlage 0.19 mm links, 0.83 mm hoch
 Streuwert 1.46, horizontal: 1.59, vertikal: 1.31

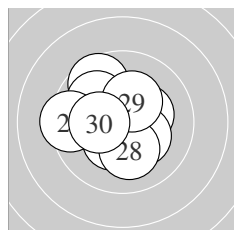

Serie 3:
 9.9 ↘ 10.4 * 10.3 * 9.6 ↘ 10.3 *
 10.0 ↘ 9.4 ← 10.1 ↓ 10.3 * 10.3 *
 beste Teiler 149.0 (22.) 163.8 (23.) 166.9 (29.)
 Trefferlage 0.76 mm links, 0.39 mm hoch
 Streuwert 1.64, horizontal: 1.74, vertikal: 1.54

Unterschrift des Schützen

Ergebnis: **303.6** (290)
 Serien: 103.7 99.9 100.0
 Zähler: 21 8 1 0 0 0 0 0 0 0
 Innenzehner: 17
 weiteste: 514 (25), 437 (27), 403 (13)
 beste Teiler 69.3 (23.) 71.6 (3.) 79.2 (17.)
 Trefferlage 0.74 mm links, 1.04 mm hoch
 Streuwert 1.46, horizontal: 1.69, vertikal: 1.18

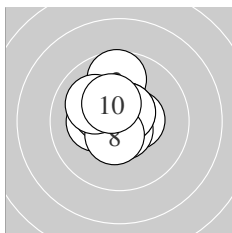
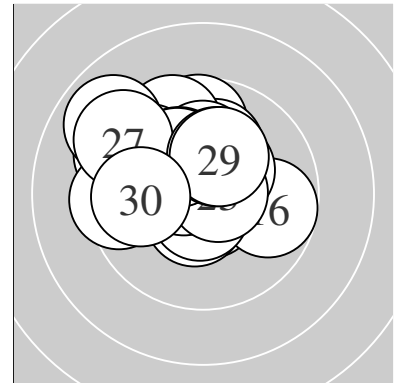

Serie 1:
 10.5 * 9.7 ↑ 10.7 * 10.6 * 10.6 *
 10.2 * 10.4 * 10.5 * 10.1 ↖ 10.4 *
 beste Teiler 71.6 (3.) 81.5 (4.) 81.8 (5.)
 Trefferlage 0.37 mm links, 0.61 mm hoch
 Streuwert 1.10, horizontal: 1.02, vertikal: 1.18

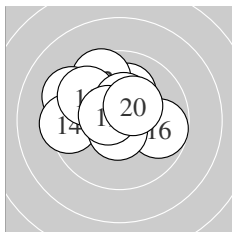

Serie 2:
 10.1 ↑ 9.6 ↘ 9.3 ↖ 9.4 ← 9.7 ↖
 9.8 → 10.6 * 10.4 * 10.6 * 10.4 *
 beste Teiler 79.2 (17.) 94.5 (19.) 138.2 (18.)
 Trefferlage 0.75 mm links, 0.99 mm hoch
 Streuwert 1.76, horizontal: 2.13, vertikal: 1.29

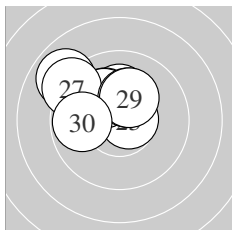

Serie 3:
 10.6 * 10.2 * 10.7 * 10.1 ↘ 8.9 ↘
 10.1 ↘ 9.2 ↘ 10.2 * 10.2 * 9.8 ←
 beste Teiler 69.3 (23.) 88.6 (21.) 179.6 (28.)
 Trefferlage 1.09 mm links, 1.51 mm hoch
 Streuwert 1.47, horizontal: 1.82, vertikal: 1.00

Unterschrift des Schützen

Ergebnis: **304.1** (289)
 Serien: 98.7 103.9 101.5
 Zähler: 20 9 1 0 0 0 0 0 0 0
 Innenzehner: 15
 weiteste: 521 (4), 353 (9), 342 (30)
 beste Teiler 21.0 (12.) 49.9 (11.) 56.0 (21.)
 Trefferlage 0.13 mm rechts, 0.32 mm tief
 Streuwert 1.65, horizontal: 1.88, vertikal: 1.39

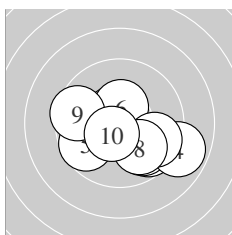
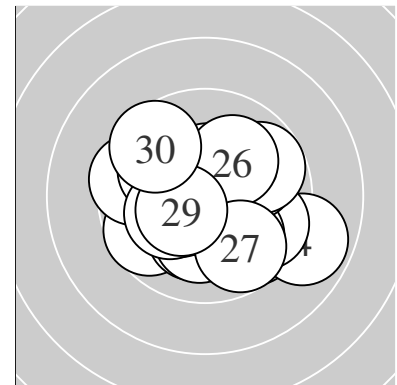

Serie 1:
 9.7 ↘ 10.6 * 9.8 ↘ 8.9 ↘ 9.7 ↙
 10.4 * 9.7 ↘ 9.9 ↘ 9.5 ← 10.5 *
 beste Teiler 94.8 (2.) 108.0 (10.) 131.4 (6.)
 Trefferlage 0.63 mm rechts, 0.92 mm tief
 Streuwert 2.05, horizontal: 2.55, vertikal: 1.37

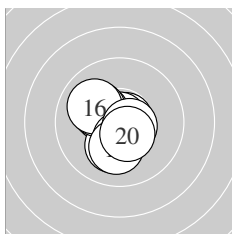

Serie 2:
 10.8 * 10.9 * 10.3 * 10.2 * 10.1 ↖
 10.0 ↖ 10.4 * 10.6 * 10.1 ↓ 10.5 *
 beste Teiler 21.0 (12.) 49.9 (11.) 88.0 (18.)
 Trefferlage 0.41 mm links, 0.30 mm tief
 Streuwert 1.11, horizontal: 1.02, vertikal: 1.20

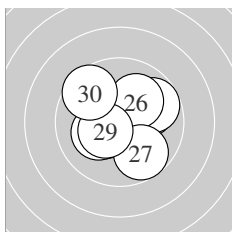

Serie 3:
 10.7 * 10.0 ↗ 10.4 * 10.6 * 9.8 ↗
 10.1 ↗ 9.7 ↘ 10.2 * 10.4 * 9.6 ↖
 beste Teiler 56.0 (21.) 78.0 (24.) 134.9 (29.)
 Trefferlage 0.18 mm rechts, 0.25 mm hoch
 Streuwert 1.63, horizontal: 1.78, vertikal: 1.47

Unterschrift des Schützen

Ergebnis: **303.9** (290)
 Serien: 100.4 104.0 99.5
 Zähler: 20 10 0 0 0 0 0 0 0 0
 Innenzehner: 17
 weiteste: 483 (24), 477 (4), 403 (26)
 beste Teiler 19.4 (12.) 34.4 (16.) 38.1 (27.)
 Trefferlage 0.38 mm links, 0.45 mm tief
 Streuwert 1.66, horizontal: 1.71, vertikal: 1.61

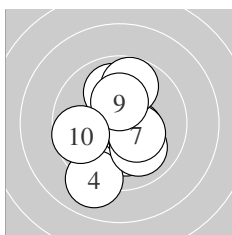
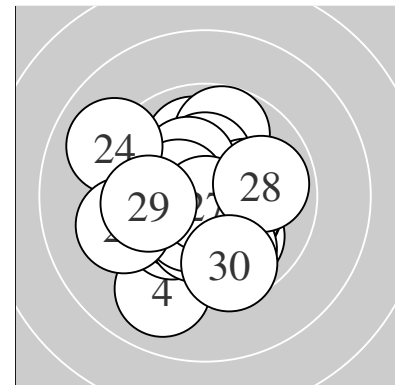

Serie 1:
 10.0 ↑ 10.2 * 10.6 * 9.0 ↙ 10.5 *
 10.0 ↘ 10.3 * 9.8 ↑ 10.3 * 9.7 ←
 beste Teiler 96.1 (3.) 125.7 (5.) 154.6 (7.)
 Trefferlage 0.04 mm rechts, 0.38 mm tief
 Streuwert 1.88, horizontal: 1.50, vertikal: 2.19

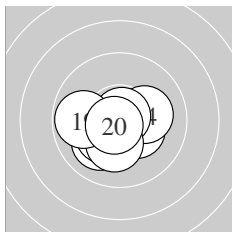

Serie 2:
 10.4 * 10.9 * 10.1 ↙ 10.2 * 10.6 *
 10.8 * 10.3 * 10.2 * 9.8 ← 10.7 *
 beste Teiler 19.4 (12.) 34.4 (16.) 58.0 (20.)
 Trefferlage 0.34 mm links, 0.54 mm tief
 Streuwert 1.11, horizontal: 1.36, vertikal: 0.79

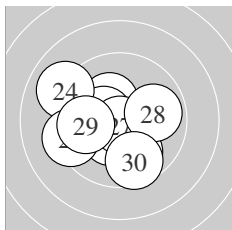

Serie 3:
 10.3 * 9.9 ↘ 10.4 * 9.0 ↘ 10.4 *
 9.3 ← 10.8 * 9.9 → 9.9 ← 9.6 ↘
 beste Teiler 38.1 (27.) 129.9 (23.) 147.1 (25.)
 Trefferlage 0.85 mm links, 0.43 mm tief
 Streuwert 1.97, horizontal: 2.22, vertikal: 1.70

Unterschrift des Schützen

Meyton Elektronik

Ergebnis: **309.1** (296)
 Serien: 103.1 104.6 101.4
 Zähler: 26 4 0 0 0 0 0 0 0 0
 Innenzehner: 22
 weiteste: 380 (30), 341 (25), 268 (29)
 beste Teiler 51.6 (12.) 53.0 (26.) 72.2 (4.)
 Trefferlage 0.20 mm rechts, 0.21 mm hoch
 Streuwert 1.26, horizontal: 1.30, vertikal: 1.21

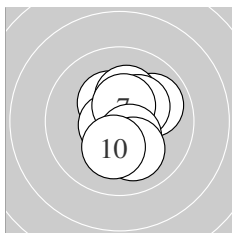
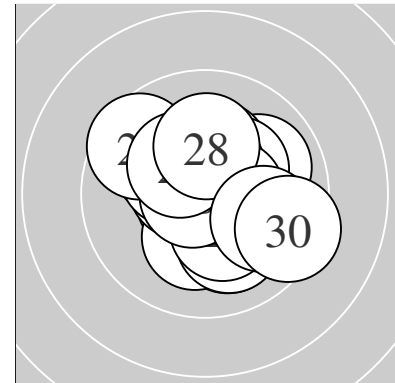

Serie 1:
 10.4 * 9.9 ↗ 10.4 * 10.7 * 10.2 *
 10.3 * 10.5 * 10.4 * 10.1 ↓ 10.2 *
 beste Teiler 72.2 (4.) 113.7 (7.) 126.7 (8.)
 Trefferlage 0.53 mm rechts, 0.16 mm hoch
 Streuwert 1.17, horizontal: 0.96, vertikal: 1.35

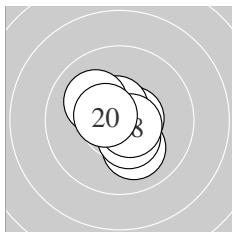

Serie 2:
 10.1 ↓ 10.7 * 10.5 * 10.5 * 10.4 *
 10.6 * 10.6 * 10.6 * 10.1 ↖ 10.5 *
 beste Teiler 51.6 (12.) 83.6 (18.) 89.8 (16.)
 Trefferlage 0.07 mm links, 0.13 mm hoch
 Streuwert 0.98, horizontal: 0.92, vertikal: 1.03

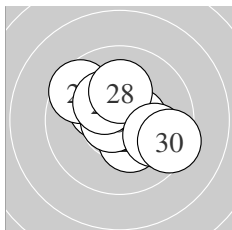

Serie 3:
 10.3 * 10.3 * 10.3 * 10.5 * 9.6 ↖
 10.7 * 10.3 * 10.1 ↑ 9.9 ↘ 9.4 ↘
 beste Teiler 53.0 (26.) 111.1 (24.) 151.0 (22.)
 Trefferlage 0.14 mm rechts, 0.34 mm hoch
 Streuwert 1.63, horizontal: 1.87, vertikal: 1.35

Unterschrift des Schützen

Ergebnis: **313.7** (300)
 Serien: 103.1 105.2 105.4
 Zähler: 30 0 0 0 0 0 0 0 0 0
 Innenzehner: 24
 weiteste: 244 (9), 243 (5), 239 (11)
 beste Teiler 29.2 (18.) 33.0 (29.) 43.4 (12.)
 Trefferlage 0.44 mm links, 0.09 mm hoch
 Streuwert 0.97, horizontal: 0.97, vertikal: 0.97

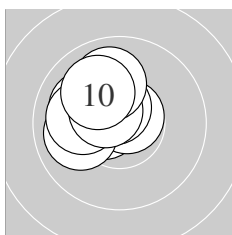
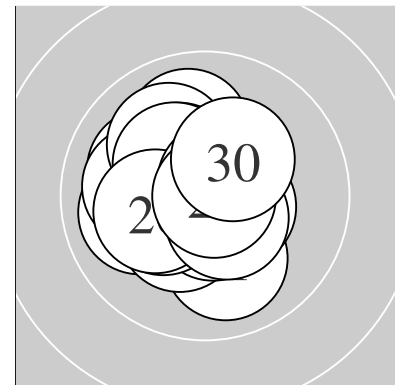

Serie 1:
 10.5 * 10.6 * 10.1 ↖ 10.7 * 10.0 ←
 10.1 ← 10.6 * 10.5 * 10.0 ↑ 10.0 ↘
 beste Teiler 60.2 (4.) 95.1 (2.) 100.2 (7.)
 Trefferlage 1.12 mm links, 0.74 mm hoch
 Streuwert 0.88, horizontal: 0.89, vertikal: 0.86

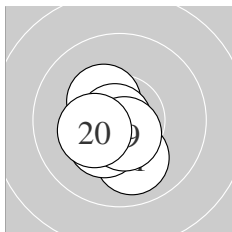

Serie 2:
 10.0 ↓ 10.8 * 10.4 * 10.7 * 10.7 *
 10.6 * 10.3 * 10.8 * 10.6 * 10.3 *
 beste Teiler 29.2 (18.) 43.4 (12.) 52.1 (14.)
 Trefferlage 0.38 mm links, 0.61 mm tief
 Streuwert 0.76, horizontal: 0.65, vertikal: 0.86

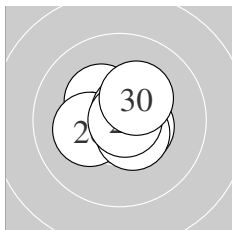

Serie 3:
 10.5 * 10.7 * 10.7 * 10.3 * 10.7 *
 10.2 * 10.7 * 10.5 * 10.8 * 10.3 *
 beste Teiler 33.0 (29.) 61.2 (22.) 63.5 (23.)
 Trefferlage 0.17 mm rechts, 0.15 mm hoch
 Streuwert 0.84, horizontal: 0.93, vertikal: 0.74

Unterschrift des Schützen

Ergebnis: **305.7** (295)
 Serien: 100.3 103.1 102.3
 Zähler: 26 3 1 0 0 0 0 0 0 0
 Innenzehner: 17
 weiteste: 749 (5), 332 (25), 267 (10)
 beste Teiler 39.0 (17.) 48.1 (9.) 88.0 (8.)
 Trefferlage 0.14 mm links, 0.17 mm hoch
 Streuwert 1.63, horizontal: 2.01, vertikal: 1.14

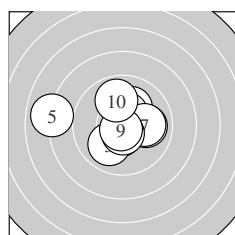
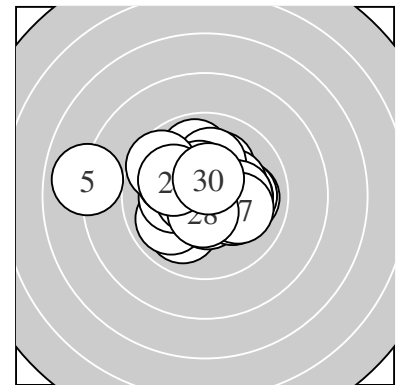

Serie 1:
 10.5 * 10.1 ↗ 10.0 ↙ 10.0 → 8.0 ←
 10.4 * 10.0 → 10.6 * 10.8 * 9.9 ↑
 beste Teiler 48.1 (9.) 88.0 (8.) 111.0 (1.)
 Trefferlage 0.38 mm links, 0.21 mm hoch
 Streuwert 2.19, horizontal: 2.75, vertikal: 1.42

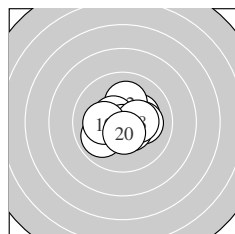

Serie 2:
 10.2 * 10.1 ↑ 9.9 ↙ 10.1 → 10.5 *
 10.5 * 10.8 * 10.3 * 10.2 * 10.5 *
 beste Teiler 39.0 (17.) 109.5 (15.) 113.1 (20.)
 Trefferlage 0.15 mm rechts, 0.05 mm tief
 Streuwert 1.26, horizontal: 1.46, vertikal: 1.01

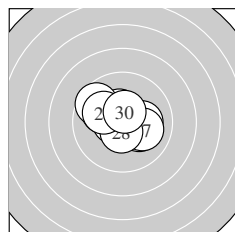

Serie 3:
 10.0 ↘ 10.4 * 10.2 * 10.6 * 9.6 ↖
 10.2 * 10.1 ↘ 10.6 * 10.1 ↖ 10.5 *
 beste Teiler 91.1 (24.) 100.8 (28.) 110.0 (30.)
 Trefferlage 0.21 mm links, 0.35 mm hoch
 Streuwert 1.43, horizontal: 1.75, vertikal: 1.02

Unterschrift des Schützen

Ergebnis: **307.9** (296)
 Serien: 101.5 103.4 103.0
 Zähler: 26 4 0 0 0 0 0 0 0 0
 Innenzehner: 20
 weiteste: 372 (11), 326 (10), 290 (5)
 beste Teiler 9.4 (16.) 51.1 (13.) 71.1 (3.)
 Trefferlage 0.56 mm links, 0.26 mm hoch
 Streuwert 1.28, horizontal: 1.50, vertikal: 1.01

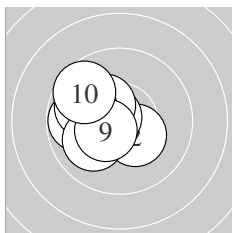
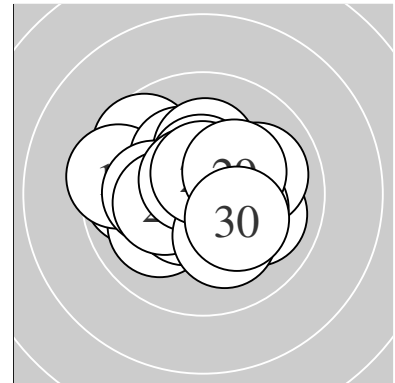

Serie 1:
 10.0 ↘ 10.4 * 10.7 * 10.3 * 9.8 ←
 10.3 * 9.9 ↙ 10.0 ↗ 10.5 * 9.6 ↖
 beste Teiler 71.1 (3.) 118.4 (9.) 150.8 (2.)
 Trefferlage 1.47 mm links, 0.25 mm hoch
 Streuwert 1.14, horizontal: 1.16, vertikal: 1.11

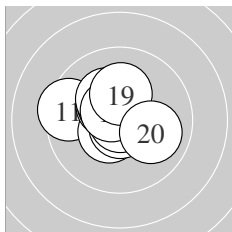

Serie 2:
 9.5 ← 10.5 * 10.7 * 10.4 * 10.4 *
 10.9 * 10.2 * 10.6 * 10.2 * 10.0 →
 beste Teiler 9.4 (16.) 51.1 (13.) 90.1 (18.)
 Trefferlage 0.51 mm links, 0.47 mm hoch
 Streuwert 1.24, horizontal: 1.45, vertikal: 0.98

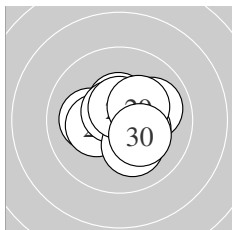

Serie 3:
 10.1 ← 10.3 * 10.0 → 10.5 * 10.3 *
 10.6 * 10.1 ↓ 10.6 * 10.3 * 10.2 *
 beste Teiler 80.8 (26.) 89.0 (28.) 117.3 (24.)
 Trefferlage 0.30 mm rechts, 0.06 mm hoch
 Streuwert 1.24, horizontal: 1.44, vertikal: 1.00

Unterschrift des Schützen

Ergebnis: **299.3** (283)
 Serien: 99.7 100.1 99.5
 Zähler: 14 15 1 0 0 0 0 0 0 0
 Innenzehner: 12
 weiteste: 601 (4), 469 (26), 419 (13)
 beste Teiler 25.0 (6.) 42.0 (16.) 47.1 (22.)
 Trefferlage 0.11 mm rechts, 0.08 mm hoch
 Streuwert 2.02, horizontal: 2.28, vertikal: 1.72

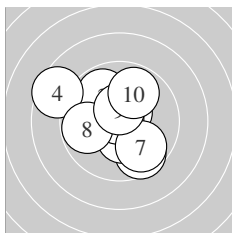
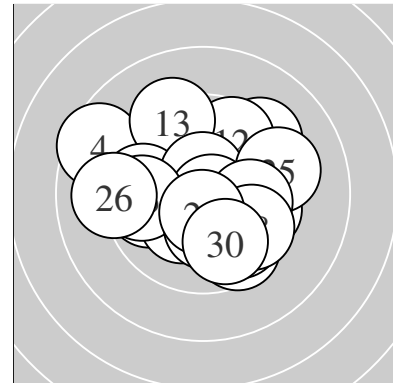

Serie 1:
 9.6 ↘ 10.4 * 9.8 ↖ 8.5 ↖ 10.6 *
 10.9 * 9.8 ↘ 9.8 ← 10.5 * 9.8 ↗
 beste Teiler 25.0 (6.) 98.0 (5.) 105.0 (9.)
 Trefferlage 0.41 mm links, 0.23 mm hoch
 Streuwert 2.13, horizontal: 2.29, vertikal: 1.96

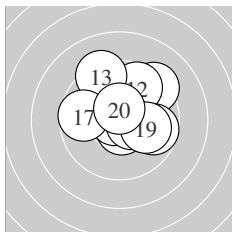

Serie 2:
 9.3 ↗ 9.7 ↗ 9.3 ↖ 9.7 → 10.6 *
 10.8 * 9.7 ← 10.5 * 10.0 → 10.5 *
 beste Teiler 42.0 (16.) 83.1 (15.) 101.0 (20.)
 Trefferlage 0.57 mm rechts, 0.83 mm hoch
 Streuwert 1.87, horizontal: 2.00, vertikal: 1.74

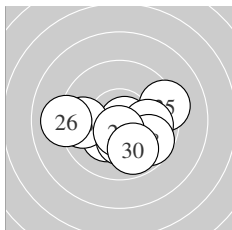

Serie 3:
 10.2 * 10.8 * 9.7 ← 10.3 * 9.3 →
 9.1 ← 10.0 → 9.7 ↘ 10.6 * 9.8 ↘
 beste Teiler 47.1 (22.) 98.1 (29.) 174.9 (24.)
 Trefferlage 0.16 mm rechts, 0.80 mm tief
 Streuwert 2.03, horizontal: 2.65, vertikal: 1.09

Unterschrift des Schützen

Ergebnis: **286.5** (274)
 Serien: 95.7 95.2 95.6
 Zähler: 11 13 5 1 0 0 0 0 0 0
 Innenzehner: 6
 weiteste: 905 (24), 631 (16), 618 (5)
 beste Teiler 57.2 (7.) 71.1 (21.) 115.7 (26.)
 Trefferlage 0.87 mm rechts, 0.42 mm hoch
 Streuwert 2.77, horizontal: 2.68, vertikal: 2.86

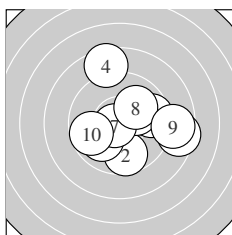
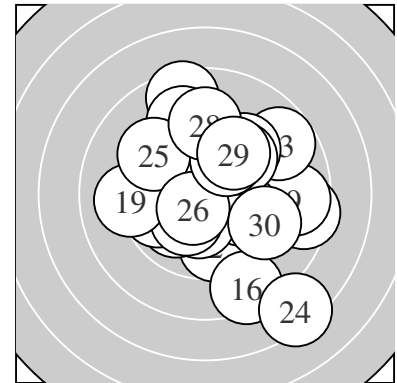

Serie 1:
 9.6 → 9.7 ↓ 10.0 ↙ 8.5 ↑ 8.5 →
 10.2 * 10.7 * 10.0 ↗ 8.8 → 9.7 ←
 beste Teiler 57.2 (7.) 195.0 (6.) 231.9 (8.)
 Trefferlage 1.21 mm rechts, 0.16 mm hoch
 Streuwert 2.76, horizontal: 3.03, vertikal: 2.46

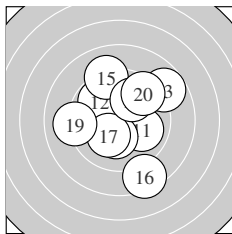

Serie 2:
 10.0 ↘ 9.8 ↖ 8.8 ↗ 10.3 * 9.1 ↑
 8.4 ↓ 10.2 * 10.0 ↗ 9.1 ← 9.5 ↗
 beste Teiler 175.9 (14.) 192.4 (17.) 244.5 (18.)
 Trefferlage 0.35 mm rechts, 0.38 mm hoch
 Streuwert 2.88, horizontal: 2.73, vertikal: 3.03

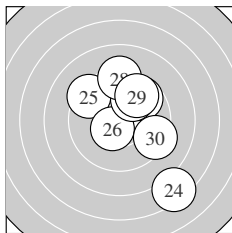

Serie 3:
 10.7 * 9.8 ↑ 9.7 ↗ 7.3 ↘ 9.4 ↖
 10.5 * 10.0 ↗ 9.2 ↑ 9.7 ↗ 9.3 ↘
 beste Teiler 71.1 (21.) 115.7 (26.) 248.8 (27.)
 Trefferlage 1.04 mm rechts, 0.72 mm hoch
 Streuwert 2.91, horizontal: 2.45, vertikal: 3.30

Unterschrift des Schützen

Ergebnis: **302.3** (291)
 Serien: 100.4 99.5 102.4
 Zähler: 21 9 0 0 0 0 0 0 0 0
 Innenzehner: 16
 weiteste: 463 (2), 413 (17), 413 (18)
 beste Teiler 65.9 (20.) 77.1 (29.) 79.0 (24.)
 Trefferlage 0.09 mm links, 0.11 mm hoch
 Streuwert 1.75, horizontal: 1.90, vertikal: 1.59

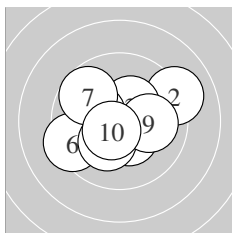
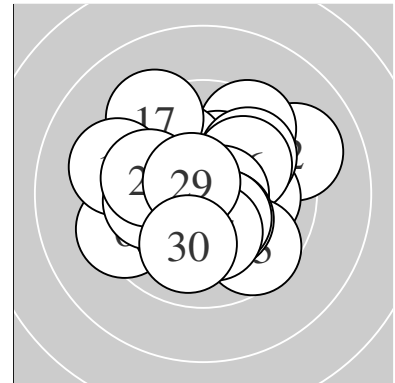

Serie 1:
 10.3 * 9.1 ↗ 10.4 * 10.4 * 10.2 *
 9.4 ← 9.7 ↘ 10.2 * 10.1 → 10.6 *
 beste Teiler 95.0 (10.) 138.7 (4.) 148.9 (3.)
 Trefferlage 0.27 mm links, 0.11 mm hoch
 Streuwert 1.90, horizontal: 2.32, vertikal: 1.37

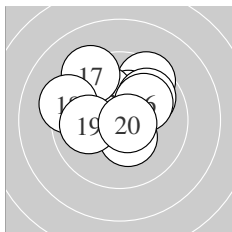

Serie 2:
 9.5 ↗ 10.3 * 10.1 ↘ 9.9 ↗ 10.4 *
 10.0 ↗ 9.3 ↘ 9.3 ← 10.0 ← 10.7 *
 beste Teiler 65.9 (20.) 146.2 (15.) 172.0 (12.)
 Trefferlage 0.17 mm links, 1.24 mm hoch
 Streuwert 1.83, horizontal: 2.11, vertikal: 1.50

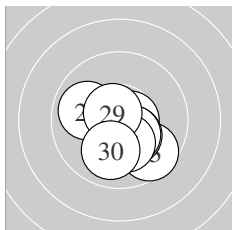

Serie 3:
 10.3 * 10.5 * 9.6 ↘ 10.6 * 10.3 *
 10.4 * 10.2 * 9.9 ← 10.6 * 10.0 ↓
 beste Teiler 77.1 (29.) 79.0 (24.) 107.3 (22.)
 Trefferlage 0.16 mm rechts, 1.00 mm tief
 Streuwert 1.20, horizontal: 1.28, vertikal: 1.11

Unterschrift des Schützen

Ergebnis: **302.0** (288)
 Serien: 99.5 100.9 101.6
 Zähler: 22 5 2 1 0 0 0 0 0 0
 Innenzehner: 20
 weiteste: 965 (6), 572 (19), 519 (26)
 beste Teiler 41.0 (18.) 45.8 (15.) 71.8 (10.)
 Trefferlage 0.31 mm links, 0.43 mm hoch
 Streuwert 2.06, horizontal: 2.29, vertikal: 1.81

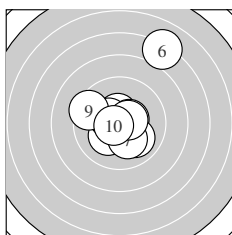
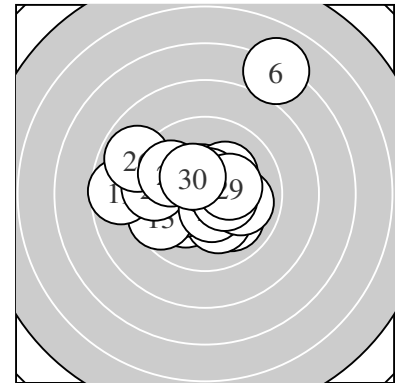

Serie 1:
 10.5 * 10.5 * 10.2 * 10.4 * 10.0 ↘
 7.1 ↗ 10.2 * 10.5 * 9.4 ↖ 10.7 *
 beste Teiler 71.8 (10.) 101.8 (8.) 115.1 (1.)
 Trefferlage 0.26 mm rechts, 0.72 mm hoch
 Streuwert 2.60, horizontal: 2.23, vertikal: 2.92

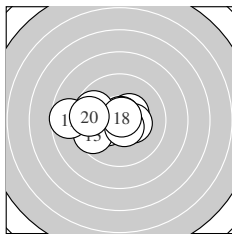

Serie 2:
 10.4 * 10.3 * 9.6 ↙ 10.4 * 10.8 *
 9.7 ↖ 10.6 * 10.8 * 8.7 ← 9.6 ←
 beste Teiler 41.0 (18.) 45.8 (15.) 91.8 (17.)
 Trefferlage 1.30 mm links, 0.00 mm
 Streuwert 1.77, horizontal: 2.37, vertikal: 0.80

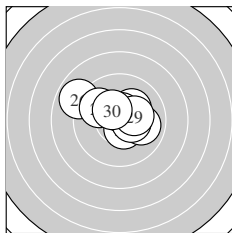

Serie 3:
 10.2 * 10.5 * 10.0 → 10.4 * 10.6 *
 8.9 ↖ 9.9 ↖ 10.4 * 10.3 * 10.4 *
 beste Teiler 89.2 (25.) 112.8 (22.) 133.0 (24.)
 Trefferlage 0.09 mm rechts, 0.57 mm hoch
 Streuwert 1.69, horizontal: 2.15, vertikal: 1.05

Unterschrift des Schützen

Ergebnis: **306.0** (292)
 Serien: 101.4 102.8 101.8
 Zähler: 22 8 0 0 0 0 0 0 0 0
 Innenzehner: 19
 weiteste: 406 (29), 340 (7), 340 (26)
 beste Teiler 37.0 (18.) 76.6 (22.) 78.3 (1.)
 Trefferlage 0.00 mm , 0.55 mm hoch
 Streuwert 1.46, horizontal: 1.53, vertikal: 1.38

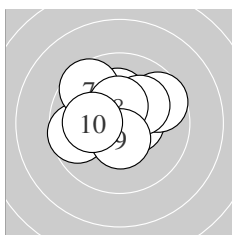
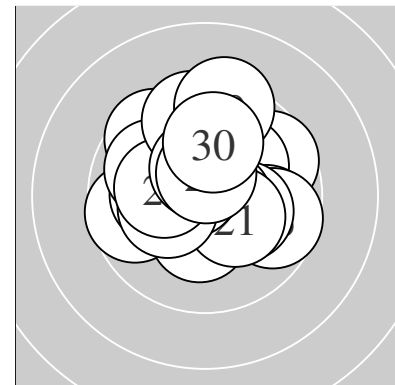

Serie 1:
 10.6 * 10.5 * 10.2 * 9.7 ↗ 10.1 ↗
 9.7 ← 9.6 ↘ 10.4 * 10.5 * 10.1 ←
 beste Teiler 78.3 (1.) 109.0 (2.) 117.2 (9.)
 Trefferlage 0.29 mm links, 0.64 mm hoch
 Streuwert 1.56, horizontal: 1.84, vertikal: 1.23

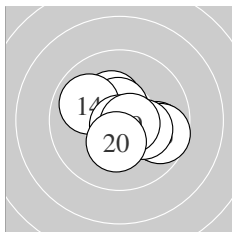

Serie 2:
 9.8 → 10.3 * 10.6 * 9.9 ↖ 10.6 *
 9.7 → 10.2 * 10.8 * 10.6 * 10.3 *
 beste Teiler 37.0 (18.) 80.9 (19.) 94.3 (15.)
 Trefferlage 0.58 mm rechts, 0.16 mm tief
 Streuwert 1.34, horizontal: 1.60, vertikal: 1.02

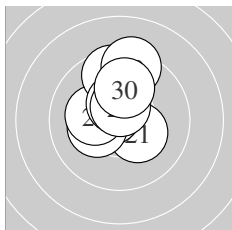

Serie 3:
 10.3 * 10.6 * 10.6 * 10.3 * 10.2 *
 9.6 ↑ 10.4 * 10.5 * 9.3 ↑ 10.0 ↑
 beste Teiler 76.6 (22.) 79.2 (23.) 102.1 (28.)
 Trefferlage 0.29 mm links, 1.18 mm hoch
 Streuwert 1.34, horizontal: 1.01, vertikal: 1.60

Unterschrift des Schützen

Ergebnis: **311.6** (299)
 Serien: 102.3 104.1 105.2
 Zähler: 29 1 0 0 0 0 0 0 0 0
 Innenzehner: 26
 weiteste: 368 (3), 241 (7), 232 (18)
 beste Teiler 40.3 (29.) 42.4 (23.) 44.1 (27.)
 Trefferlage 0.22 mm links, 0.24 mm hoch
 Streuwert 1.12, horizontal: 1.35, vertikal: 0.82

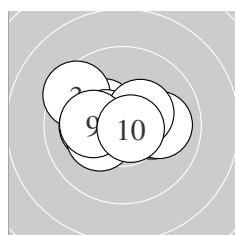
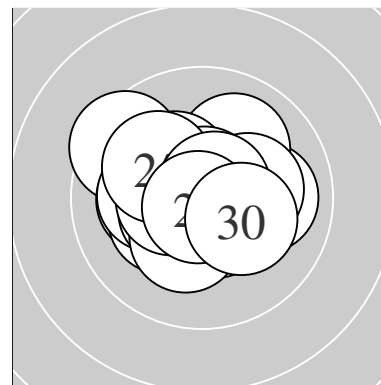

Serie 1:
 10.2 * 10.3 * 9.5 ↘ 10.5 * 10.2 *
 10.3 * 10.0 → 10.4 * 10.2 * 10.7 *
 beste Teiler 58.6 (10.) 113.6 (4.) 143.1 (8.)
 Trefferlage 0.48 mm links, 0.28 mm hoch
 Streuwert 1.43, horizontal: 1.87, vertikal: 0.78

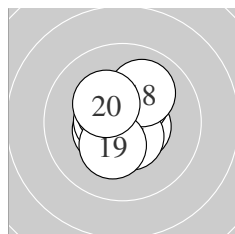

Serie 2:
 10.5 * 10.5 * 10.5 * 10.5 * 10.7 *
 10.3 * 10.5 * 10.0 ↗ 10.3 * 10.3 *
 beste Teiler 68.0 (15.) 103.1 (13.) 103.3 (12.)
 Trefferlage 0.14 mm links, 0.26 mm hoch
 Streuwert 1.03, horizontal: 0.95, vertikal: 1.10

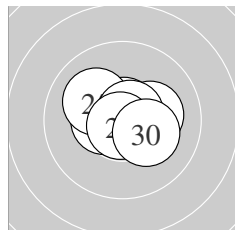

Serie 3:
 10.4 * 10.7 * 10.8 * 10.5 * 10.1 ↘
 10.2 * 10.8 * 10.7 * 10.8 * 10.2 *
 beste Teiler 40.3 (29.) 42.4 (23.) 44.1 (27.)
 Trefferlage 0.03 mm links, 0.20 mm hoch
 Streuwert 0.93, horizontal: 1.18, vertikal: 0.59

Unterschrift des Schützen

Meyton Elektronik

Ergebnis: **312.3** (300)
 Serien: 104.1 104.7 103.5
 Zähler: 30 0 0 0 0 0 0 0 0 0
 Innenzehner: 23
 weiteste: 249 (14), 232 (15), 221 (27)
 beste Teiler 27.0 (19.) 32.2 (26.) 47.6 (18.)
 Trefferlage 0.10 mm links, 0.64 mm hoch
 Streuwert 0.97, horizontal: 1.12, vertikal: 0.78

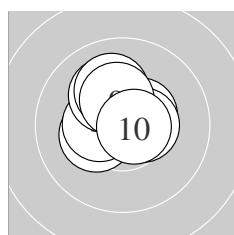
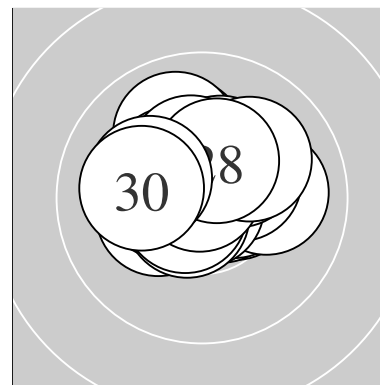

Serie 1:
 10.3 * 10.6 * 10.6 * 10.4 * 10.1 ↖
 10.5 * 10.5 * 10.1 ↖ 10.3 * 10.7 *
 beste Teiler 68.5 (10.) 99.2 (2.) 100.1 (3.)
 Trefferlage 0.34 mm links, 0.68 mm hoch
 Streuwert 0.93, horizontal: 0.98, vertikal: 0.88

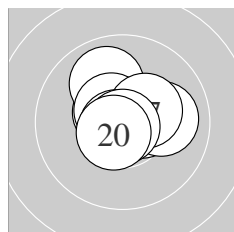

Serie 2:
 10.6 * 10.5 * 10.5 * 10.0 ↖ 10.0 →
 10.6 * 10.3 * 10.8 * 10.8 * 10.6 *
 beste Teiler 27.0 (19.) 47.6 (18.) 82.9 (20.)
 Trefferlage 0.24 mm rechts, 0.38 mm hoch
 Streuwert 0.98, horizontal: 1.11, vertikal: 0.81

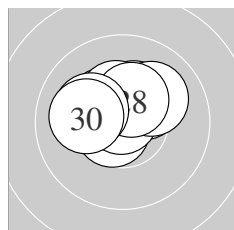

Serie 3:
 10.4 * 10.3 * 10.3 * 10.6 * 10.4 *
 10.8 * 10.1 ↗ 10.4 * 10.1 ↖ 10.1 ←
 beste Teiler 32.2 (26.) 76.4 (24.) 144.1 (28.)
 Trefferlage 0.20 mm links, 0.87 mm hoch
 Streuwert 1.02, horizontal: 1.29, vertikal: 0.64

Unterschrift des Schützen

Ergebnis: **307.8** (295)
 Serien: 100.3 103.9 103.6
 Zähler: 25 5 0 0 0 0 0 0 0 0
 Innenzehner: 20
 weiteste: 400 (3), 367 (10), 301 (16)
 beste Teiler 25.6 (25.) 40.2 (7.) 46.2 (14.)
 Trefferlage 0.31 mm links, 0.56 mm hoch
 Streuwert 1.33, horizontal: 1.38, vertikal: 1.28

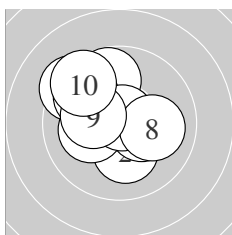
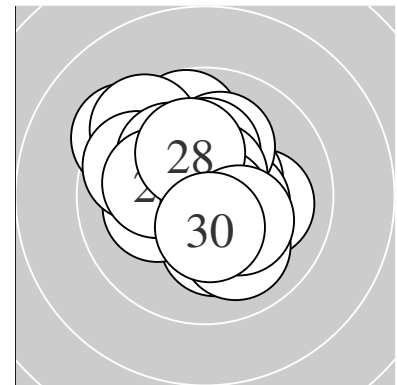

Serie 1:
 9.8 ↑ 10.2 * 9.4 ↘ 10.3 * 10.2 *
 9.8 ↘ 10.8 * 10.1 → 10.2 * 9.5 ↘
 beste Teiler 40.2 (7.) 154.4 (4.) 186.4 (9.)
 Trefferlage 0.81 mm links, 0.77 mm hoch
 Streuwert 1.72, horizontal: 1.82, vertikal: 1.60

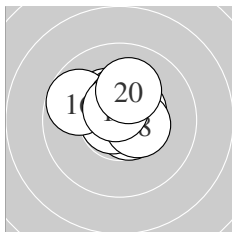

Serie 2:
 10.3 * 10.5 * 10.6 * 10.8 * 10.4 *
 9.7 ↘ 10.5 * 10.4 * 10.6 * 10.1 ↑
 beste Teiler 46.2 (14.) 79.2 (13.) 82.5 (19.)
 Trefferlage 0.10 mm links, 0.75 mm hoch
 Streuwert 0.99, horizontal: 1.14, vertikal: 0.81

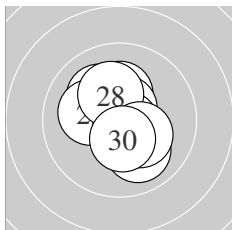

Serie 3:
 10.2 * 10.6 * 10.1 ↘ 10.0 ↘ 10.9 *
 10.1 ↘ 10.8 * 10.2 * 10.3 * 10.4 *
 beste Teiler 25.6 (25.) 50.2 (27.) 86.7 (22.)
 Trefferlage 0.02 mm links, 0.16 mm hoch
 Streuwert 1.20, horizontal: 1.05, vertikal: 1.34

Unterschrift des Schützen

Ergebnis: **311.4** (297)
 Serien: 104.6 103.7 103.1
 Zähler: 27 3 0 0 0 0 0 0 0 0
 Innenzehner: 20
 weiteste: 315 (20), 297 (23), 284 (22)
 beste Teiler 33.4 (1.) 45.0 (15.) 46.7 (27.)
 Trefferlage 0.27 mm links, 0.36 mm hoch
 Streuwert 1.14, horizontal: 1.25, vertikal: 1.02

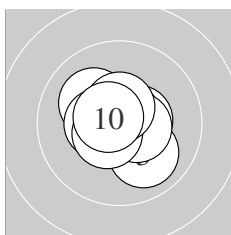
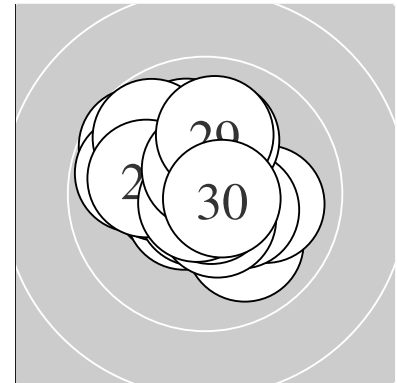

Serie 1:
 10.8 * 10.5 * 10.0 ↘ 10.1 ↘ 10.7 *
 10.5 * 10.4 * 10.5 * 10.5 * 10.6 *
 beste Teiler 33.4 (1.) 54.4 (5.) 81.8 (10.)
 Trefferlage 0.01 mm links, 0.01 mm hoch
 Streuwert 0.99, horizontal: 1.08, vertikal: 0.88

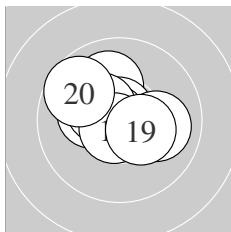

Serie 2:
 10.7 * 10.0 ↗ 10.2 * 10.8 * 10.8 *
 10.4 * 10.7 * 10.0 → 10.4 * 9.7 ↘
 beste Teiler 45.0 (15.) 50.4 (14.) 55.4 (11.)
 Trefferlage 0.29 mm links, 0.39 mm hoch
 Streuwert 1.22, horizontal: 1.44, vertikal: 0.96

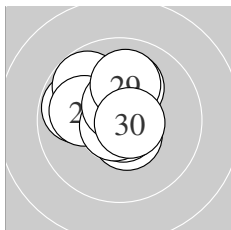

Serie 3:
 10.5 * 9.8 ↖ 9.8 ↘ 10.1 ↑ 10.8 *
 10.0 ↖ 10.8 * 10.6 * 10.0 ↑ 10.7 *
 beste Teiler 46.7 (27.) 48.7 (25.) 66.4 (30.)
 Trefferlage 0.52 mm links, 0.68 mm hoch
 Streuwert 1.24, horizontal: 1.30, vertikal: 1.17

Unterschrift des Schützen

Ergebnis: **312.8** (298)
 Serien: 103.8 103.9 105.1
 Zähler: 28 2 0 0 0 0 0 0 0 0
 Innenzehner: 25
 weiteste: 373 (13), 251 (4), 228 (7)
 beste Teiler 5.0 (17.) 19.2 (10.) 41.5 (27.)
 Trefferlage 0.15 mm links, 0.11 mm hoch
 Streuwert 1.08, horizontal: 1.06, vertikal: 1.09

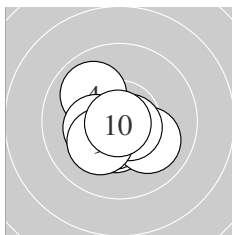
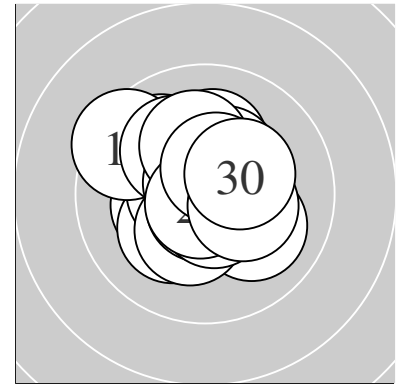

Serie 1:
 10.4 * 10.2 * 10.7 * 9.9 ↘ 10.5 *
 10.3 * 10.0 ↘ 10.7 * 10.2 * 10.9 *
 beste Teiler 19.2 (10.) 72.5 (3.) 75.7 (8.)
 Trefferlage 0.39 mm links, 0.59 mm tief
 Streuwert 1.05, horizontal: 1.15, vertikal: 0.94

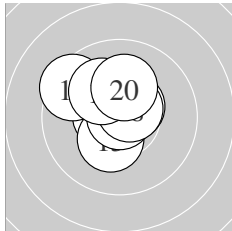

Serie 2:
 10.7 * 10.6 * 9.5 ↘ 10.5 * 10.3 *
 10.6 * 10.9 * 10.6 * 10.1 ↘ 10.1 ↑
 beste Teiler 5.0 (17.) 69.0 (11.) 81.3 (16.)
 Trefferlage 0.46 mm links, 0.64 mm hoch
 Streuwert 1.12, horizontal: 1.17, vertikal: 1.08

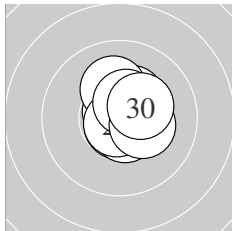

Serie 3:
 10.7 * 10.7 * 10.7 * 10.3 * 10.6 *
 10.2 * 10.8 * 10.5 * 10.3 * 10.3 *
 beste Teiler 41.5 (27.) 52.4 (21.) 52.8 (23.)
 Trefferlage 0.37 mm rechts, 0.29 mm hoch
 Streuwert 0.83, horizontal: 0.69, vertikal: 0.95

Unterschrift des Schützen

Ergebnis: **312.0** (297)
 Serien: 103.3 103.4 105.3
 Zähler: 27 3 0 0 0 0 0 0 0 0
 Innenzehner: 23
 weiteste: 311 (11), 266 (14), 263 (12)
 beste Teiler 22.0 (23.) 31.9 (15.) 36.3 (26.)
 Trefferlage 0.06 mm links, 0.01 mm tief
 Streuwert 1.13, horizontal: 1.16, vertikal: 1.10

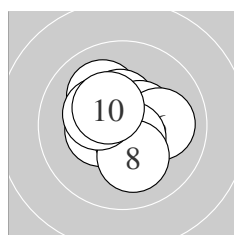
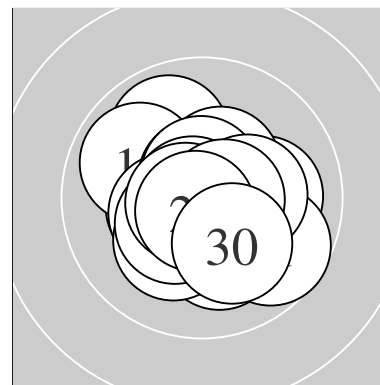

Serie 1:
 10.1 ↖ 10.5 * 10.4 * 10.5 * 10.4 *
 10.0 → 10.6 * 10.1 ↓ 10.3 * 10.4 *
 beste Teiler 89.1 (7.) 118.5 (4.) 123.9 (2.)
 Trefferlage 0.19 mm links, 0.32 mm hoch
 Streuwert 1.18, horizontal: 1.27, vertikal: 1.10

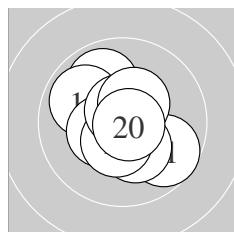

Serie 2:
 9.7 ↘ 9.9 ↖ 10.3 * 9.9 ↖ 10.8 *
 10.4 * 10.5 * 10.7 * 10.4 * 10.8 *
 beste Teiler 31.9 (15.) 41.2 (20.) 74.1 (18.)
 Trefferlage 0.05 mm links, 0.04 mm hoch
 Streuwert 1.35, horizontal: 1.35, vertikal: 1.34

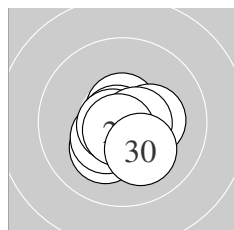

Serie 3:
 10.2 * 10.6 * 10.9 * 10.3 * 10.4 *
 10.8 * 10.7 * 10.6 * 10.7 * 10.1 ↓
 beste Teiler 22.0 (23.) 36.3 (26.) 55.0 (29.)
 Trefferlage 0.04 mm rechts, 0.41 mm tief
 Streuwert 0.85, horizontal: 0.92, vertikal: 0.79

Unterschrift des Schützen

Ergebnis: **296.3** (286)
 Serien: 98.0 99.3 99.0
 Zähler: 18 11 0 1 0 0 0 0 0 0
 Innenzehner: 9
 weiteste: 936 (17), 488 (4), 483 (2)
 beste Teiler 101.4 (20.) 106.1 (12.) 108.6 (18.)
 Trefferlage 0.98 mm links, 0.50 mm tief
 Streuwert 2.11, horizontal: 2.47, vertikal: 1.68

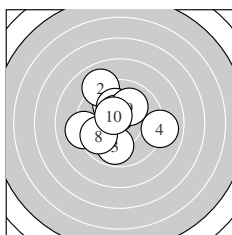
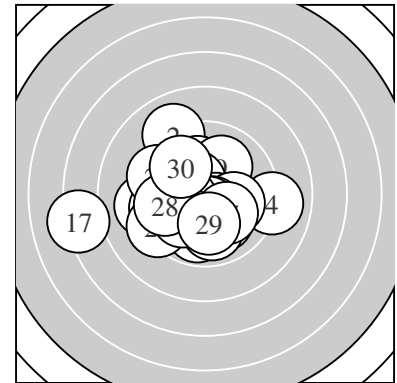

Serie 1:
 10.0 ↖ 9.0 ↖ 9.9 ↓ 9.0 → 9.2 ←
 10.1 ↖ 10.5 * 9.8 ↙ 10.0 ↗ 10.5 *
 beste Teiler 117.1 (10.) 120.2 (7.) 201.9 (6.)
 Trefferlage 0.63 mm links, 0.66 mm hoch
 Streuwert 2.26, horizontal: 2.43, vertikal: 2.07

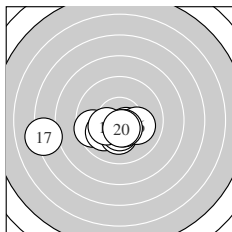

Serie 2:
 9.6 ← 10.5 * 10.0 ↙ 10.2 * 10.4 *
 10.1 → 7.2 ← 10.5 * 10.3 * 10.5 *
 beste Teiler 101.4 (20.) 106.1 (12.) 108.6 (18.)
 Trefferlage 1.23 mm links, 1.18 mm tief
 Streuwert 2.26, horizontal: 3.16, vertikal: 0.47

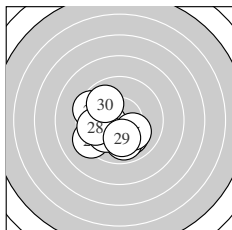

Serie 3:
 10.0 ↘ 10.4 * 9.3 ↙ 9.9 ↓ 10.1 ↘
 9.5 ↖ 10.0 ↙ 9.8 ← 10.1 ↓ 9.9 ↖
 beste Teiler 141.3 (22.) 209.0 (25.) 215.8 (29.)
 Trefferlage 1.08 mm links, 0.98 mm tief
 Streuwert 1.71, horizontal: 1.88, vertikal: 1.53

Unterschrift des Schützen

Ergebnis: **302.0** (288)
 Serien: 101.1 100.5 100.4
 Zähler: 21 6 3 0 0 0 0 0 0 0
 Innenzehner: 15
 weiteste: 539 (2), 527 (25), 519 (14)
 beste Teiler 39.4 (10.) 50.2 (12.) 53.2 (11.)
 Trefferlage 0.21 mm links, 0.17 mm tief
 Streuwert 1.88, horizontal: 2.20, vertikal: 1.48

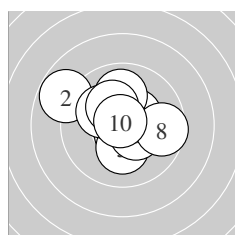
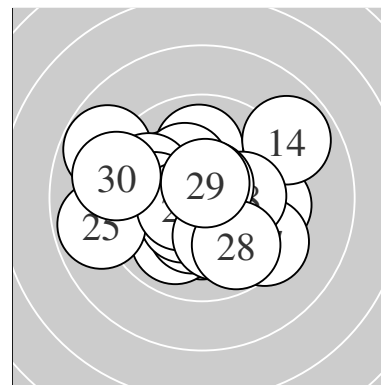

Serie 1:
 10.6 * 8.8 ↖ 10.4 * 10.0 ↑ 10.2 *
 10.4 * 10.1 ↖ 9.6 → 10.2 * 10.8 *
 beste Teiler 39.4 (10.) 76.4 (1.) 132.6 (6.)
 Trefferlage 0.24 mm links, 0.51 mm hoch
 Streuwert 1.80, horizontal: 2.10, vertikal: 1.45

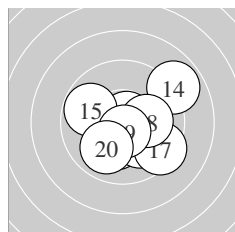

Serie 2:
 10.7 * 10.8 * 10.2 * 8.9 ↗ 9.8 ↖
 10.1 ↘ 9.4 ↘ 10.1 → 10.6 * 9.9 ↙
 beste Teiler 50.2 (12.) 53.2 (11.) 81.2 (19.)
 Trefferlage 0.74 mm rechts, 0.40 mm tief
 Streuwert 1.87, horizontal: 2.09, vertikal: 1.64

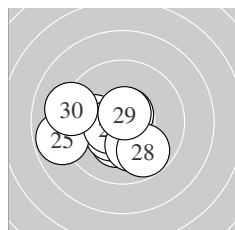

Serie 3:
 10.3 * 10.0 ← 10.7 * 10.4 * 8.8 ←
 10.5 * 10.1 ↘ 9.8 ↘ 10.6 * 9.2 ←
 beste Teiler 73.9 (23.) 76.6 (29.) 115.8 (26.)
 Trefferlage 1.13 mm links, 0.61 mm tief
 Streuwert 1.78, horizontal: 2.21, vertikal: 1.22

Unterschrift des Schützen

Meyton Elektronik

Ergebnis: **294.5** (280)
 Serien: 95.7 97.7 101.1
 Zähler: 14 12 4 0 0 0 0 0 0 0
 Innenzehner: 8
 weiteste: 611 (2), 595 (9), 578 (11)
 beste Teiler 20.3 (22.) 28.6 (23.) 70.2 (21.)
 Trefferlage 0.83 mm links, 0.03 mm hoch
 Streuwert 2.25, horizontal: 2.80, vertikal: 1.52

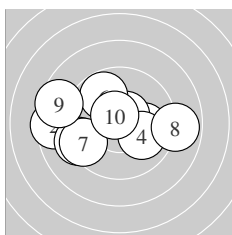
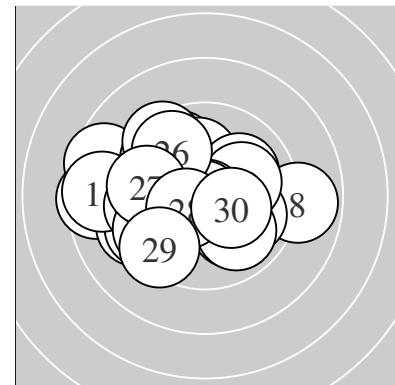

Serie 1:
 10.0 → 8.5 ← 10.6 * 10.0 ↘ 9.3 ←
 9.8 ↘ 9.4 ← 8.9 → 8.6 ← 10.6 *
 beste Teiler 87.9 (10.) 93.4 (3.) 229.5 (1.)
 Trefferlage 1.08 mm links, 0.03 mm hoch
 Streuwert 2.81, horizontal: 3.70, vertikal: 1.43

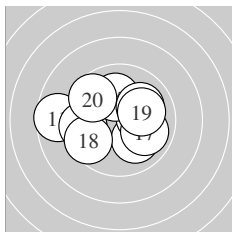

Serie 2:
 8.6 ← 10.0 ↘ 10.2 * 9.6 ← 10.1 ↑
 10.0 ↗ 9.9 ↘ 9.6 ← 10.1 → 9.6 ↘
 beste Teiler 192.2 (13.) 218.5 (15.) 218.9 (19.)
 Trefferlage 0.53 mm links, 0.14 mm hoch
 Streuwert 2.30, horizontal: 2.92, vertikal: 1.46

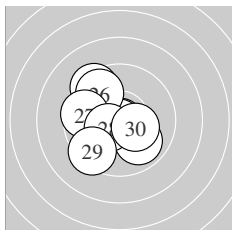

Serie 3:
 10.7 * 10.9 * 10.8 * 9.9 ↘ 9.4 ↘
 9.7 ↘ 9.6 ← 10.4 * 9.4 ↗ 10.3 *
 beste Teiler 20.3 (22.) 28.6 (23.) 70.2 (21.)
 Trefferlage 0.86 mm links, 0.07 mm tief
 Streuwert 1.75, horizontal: 1.69, vertikal: 1.80

Unterschrift des Schützen

Ergebnis: **302.1** (289)
 Serien: 102.1 99.9 100.1
 Zähler: 20 9 1 0 0 0 0 0 0 0
 Innenzehner: 15
 weiteste: 542 (27), 426 (14), 372 (3)
 beste Teiler 36.4 (1.) 68.0 (26.) 86.4 (24.)
 Trefferlage 0.47 mm rechts, 0.59 mm tief
 Streuwert 1.70, horizontal: 2.05, vertikal: 1.26

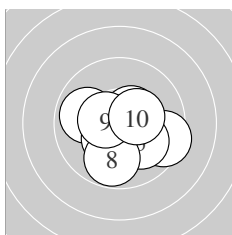
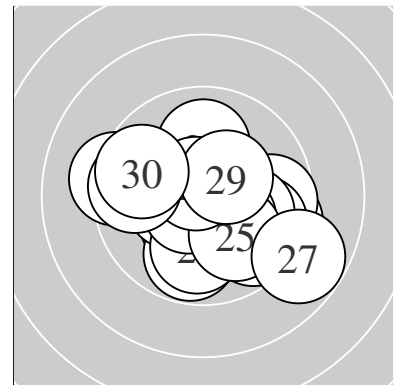

Serie 1:
 10.8 * 9.9 ← 9.5 → 10.2 * 10.1 ↘
 10.4 * 10.5 * 9.8 ↓ 10.5 * 10.4 *
 beste Teiler 36.4 (1.) 114.9 (9.) 118.6 (7.)
 Trefferlage 0.35 mm rechts, 0.62 mm tief
 Streuwert 1.48, horizontal: 1.74, vertikal: 1.17

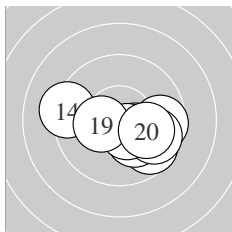

Serie 2:
 10.3 * 10.2 * 9.7 → 9.2 ← 9.7 ↘
 10.2 * 9.7 ↘ 10.5 * 10.4 * 10.0 →
 beste Teiler 109.8 (18.) 150.2 (19.) 151.2 (11.)
 Trefferlage 0.95 mm rechts, 0.84 mm tief
 Streuwert 1.68, horizontal: 2.24, vertikal: 0.80

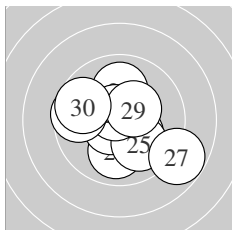

Serie 3:
 10.0 ↑ 10.3 * 10.0 ↓ 10.6 * 10.0 ↘
 10.7 * 8.8 ↘ 9.6 ← 10.4 * 9.7 ←
 beste Teiler 68.0 (26.) 86.4 (24.) 142.9 (29.)
 Trefferlage 0.10 mm rechts, 0.32 mm tief
 Streuwert 2.01, horizontal: 2.27, vertikal: 1.72

Unterschrift des Schützen

Ergebnis: **298.4** (284)
 Serien: 95.6 99.8 103.0
 Zähler: 17 10 3 0 0 0 0 0 0 0
 Innenzehner: 11
 weiteste: 577 (6), 558 (9), 531 (16)
 beste Teiler 31.9 (23.) 60.1 (12.) 65.9 (22.)
 Trefferlage 0.33 mm links, 0.17 mm hoch
 Streuwert 2.08, horizontal: 2.47, vertikal: 1.59

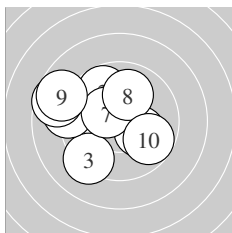
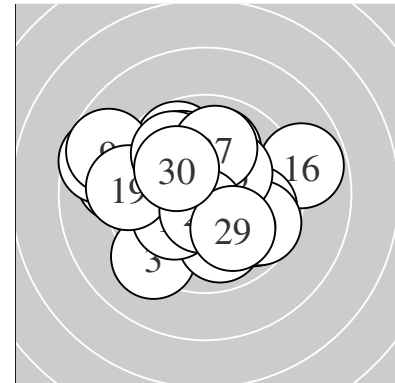

Serie 1:
 9.9 ← 9.7 ↖ 9.2 ↙ 9.1 ← 10.2 *
 8.6 ← 10.4 * 10.0 ↑ 8.7 ↖ 9.8 ↘
 beste Teiler 137.5 (7.) 198.5 (5.) 243.2 (8.)
 Trefferlage 1.81 mm links, 0.49 mm hoch
 Streuwert 2.43, horizontal: 2.84, vertikal: 1.93

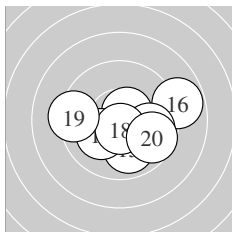

Serie 2:
 10.2 * 10.7 * 9.9 ↓ 10.6 * 10.1 ↙
 8.8 → 9.9 → 10.6 * 9.3 ← 9.7 ↘
 beste Teiler 60.1 (12.) 77.4 (18.) 91.9 (14.)
 Trefferlage 0.79 mm rechts, 0.61 mm tief
 Streuwert 1.95, horizontal: 2.51, vertikal: 1.16

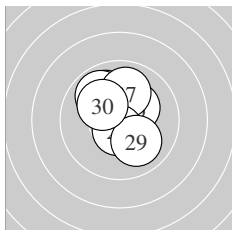

Serie 3:
 10.6 * 10.7 * 10.8 * 10.0 ↖ 9.9 ↖
 10.3 * 10.0 ↑ 10.6 * 10.0 ↘ 10.1 ↖
 beste Teiler 31.9 (23.) 65.9 (22.) 77.6 (21.)
 Trefferlage 0.01 mm rechts, 0.64 mm hoch
 Streuwert 1.29, horizontal: 1.14, vertikal: 1.42

Unterschrift des Schützen

Meyton Elektronik

Ergebnis: **291.0** (278)
 Serien: 97.0 98.6 95.4
 Zähler: 13 12 5 0 0 0 0 0 0 0
 Innenzehner: 10
 weiteste: 749 (2), 680 (10), 608 (17)
 beste Teiler 48.5 (3.) 83.3 (5.) 86.0 (12.)
 Trefferlage 1.76 mm rechts, 0.31 mm tief
 Streuwert 2.25, horizontal: 2.38, vertikal: 2.11

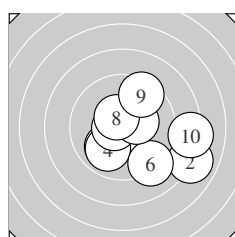
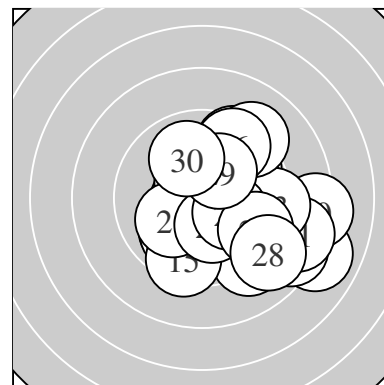

Serie 1:
 10.0 ↙ 8.0 → 10.8 * 9.9 ↙ 10.6 *
 9.1 ↘ 10.4 * 10.5 * 9.5 ↗ 8.2 →
 beste Teiler 48.5 (3.) 83.3 (5.) 114.3 (8.)
 Trefferlage 1.49 mm rechts, 0.74 mm tief
 Streuwert 2.65, horizontal: 3.11, vertikal: 2.08

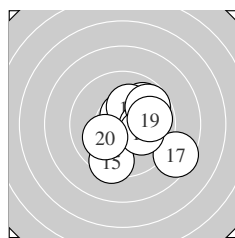

Serie 2:
 9.9 ↗ 10.6 * 10.2 * 10.2 * 9.4 ↘
 9.7 ↗ 8.5 ↘ 10.1 → 9.9 → 10.1 ↙
 beste Teiler 86.0 (12.) 183.1 (13.) 189.5 (14.)
 Trefferlage 1.40 mm rechts, 0.22 mm tief
 Streuwert 2.00, horizontal: 2.04, vertikal: 1.96

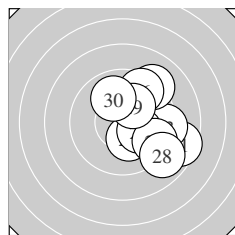

Serie 3:
 8.5 → 10.3 * 9.3 → 9.1 ↗ 10.2 *
 9.5 ↗ 9.5 ↘ 8.9 ↘ 10.2 * 9.9 ↖
 beste Teiler 172.7 (22.) 187.3 (25.) 189.7 (29.)
 Trefferlage 2.41 mm rechts, 0.02 mm hoch
 Streuwert 2.19, horizontal: 1.95, vertikal: 2.40

Unterschrift des Schützen

Meyton Elektronik

Ergebnis: **304.9** (292)
 Serien: 102.8 100.3 101.8
 Zähler: 22 8 0 0 0 0 0 0 0 0
 Innenzehner: 15
 weiteste: 407 (24), 314 (14), 269 (20)
 beste Teiler 73.3 (9.) 80.2 (10.) 92.3 (26.)
 Trefferlage 0.52 mm links, 0.43 mm hoch
 Streuwert 1.42, horizontal: 1.48, vertikal: 1.36

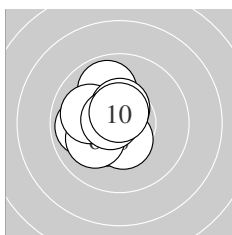
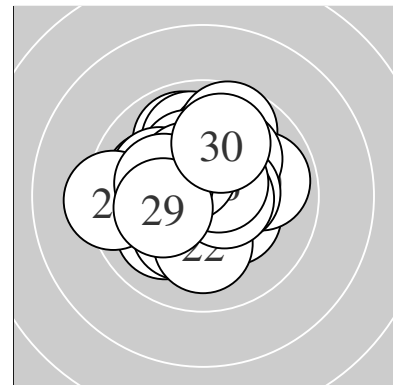

Serie 1:
 10.3 * 10.4 * 10.4 * 9.9 ← 9.9 ↑
 10.1 ↙ 10.0 ↖ 10.5 * 10.7 * 10.6 *
 beste Teiler 73.3 (9.) 80.2 (10.) 114.0 (8.)
 Trefferlage 1.02 mm links, 0.25 mm hoch
 Streuwert 1.09, horizontal: 0.98, vertikal: 1.18

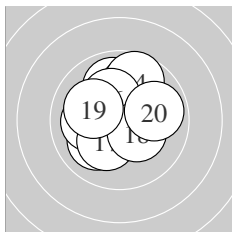

Serie 2:
 10.0 ↘ 9.9 ↑ 9.9 ↑ 9.7 ↑ 10.1 ←
 10.2 * 10.2 * 10.3 * 10.1 ↖ 9.9 →
 beste Teiler 158.1 (18.) 177.9 (16.) 184.7 (17.)
 Trefferlage 0.23 mm links, 0.69 mm hoch
 Streuwert 1.65, horizontal: 1.61, vertikal: 1.69

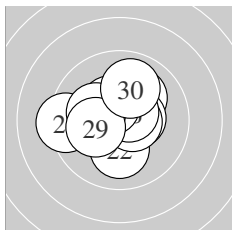

Serie 3:
 10.1 ↗ 10.1 ↓ 10.4 * 9.3 ← 10.6 *
 10.6 * 10.4 * 10.2 * 10.2 * 9.9 ↑
 beste Teiler 92.3 (26.) 97.8 (25.) 126.7 (23.)
 Trefferlage 0.32 mm links, 0.34 mm hoch
 Streuwert 1.53, horizontal: 1.76, vertikal: 1.26

Unterschrift des Schützen

Ergebnis: **311.8** (295)
 Serien: 104.6 102.1 105.1
 Zähler: 25 5 0 0 0 0 0 0 0 0
 Innenzehner: 22
 weiteste: 392 (10), 382 (17), 369 (7)
 beste Teiler 2.0 (1.) 16.7 (29.) 20.5 (2.)
 Trefferlage 0.83 mm links, 0.41 mm tief
 Streuwert 1.08, horizontal: 1.31, vertikal: 0.78

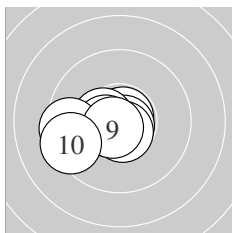
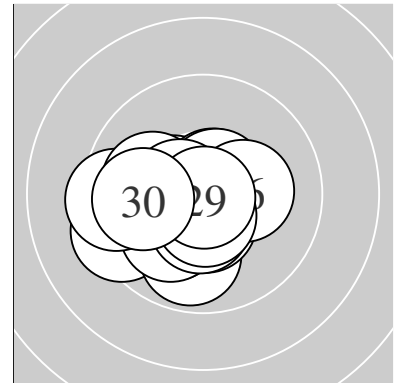

Serie 1:
 10.9 * 10.9 * 10.8 * 10.8 * 10.5 *
 10.5 * 9.5 ← 10.6 * 10.7 * 9.4 ←
 beste Teiler 2.0 (1.) 20.5 (2.) 36.0 (3.)
 Trefferlage 0.93 mm links, 0.34 mm tief
 Streuwert 1.14, horizontal: 1.51, vertikal: 0.57

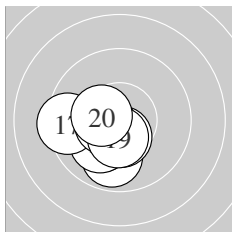

Serie 2:
 10.3 * 9.9 ↓ 10.4 * 10.1 ✓ 10.5 *
 10.1 ✓ 9.4 ← 10.5 * 10.5 * 10.4 *
 beste Teiler 109.4 (18.) 122.5 (15.) 125.6 (19.)
 Trefferlage 1.21 mm links, 0.94 mm tief
 Streuwert 1.00, horizontal: 1.07, vertikal: 0.93

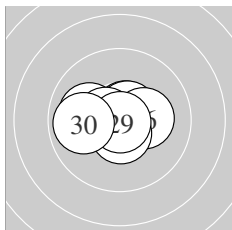

Serie 3:
 10.0 ← 10.9 * 10.7 * 10.8 * 10.6 *
 10.2 * 10.5 * 10.6 * 10.9 * 9.9 ←
 beste Teiler 16.7 (29.) 21.0 (22.) 41.1 (24.)
 Trefferlage 0.35 mm links, 0.04 mm hoch
 Streuwert 0.99, horizontal: 1.31, vertikal: 0.48

Unterschrift des Schützen

Ergebnis: **307.9** (295)
 Serien: 101.3 103.8 102.8
 Zähler: 25 5 0 0 0 0 0 0 0 0
 Innenzehner: 17
 weiteste: 283 (29), 270 (4), 264 (21)
 beste Teiler 14.8 (12.) 70.4 (19.) 71.5 (27.)
 Trefferlage 0.02 mm rechts, 0.59 mm hoch
 Streuwert 1.27, horizontal: 1.18, vertikal: 1.35

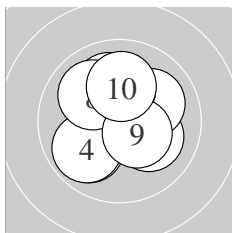
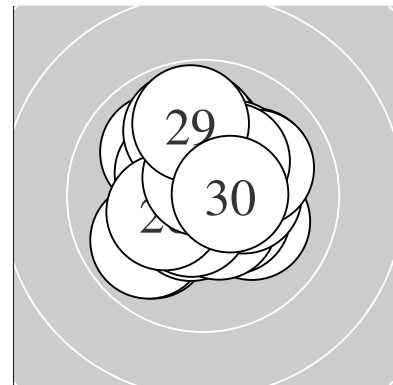

Serie 1:
 10.1 ↘ 10.4 * 9.9 ↙ 9.9 ↙ 10.5 *
 10.0 ↑ 10.0 ↗ 10.0 ↘ 10.4 * 10.1 ↑
 beste Teiler 109.5 (5.) 126.1 (2.) 136.1 (9.)
 Trefferlage 0.16 mm links, 0.32 mm hoch
 Streuwert 1.55, horizontal: 1.57, vertikal: 1.52

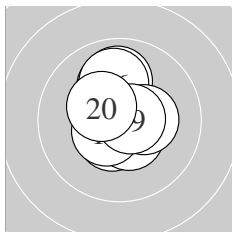

Serie 2:
 10.5 * 10.9 * 10.1 ↑ 10.5 * 9.9 ↑
 10.0 ↑ 10.5 * 10.3 * 10.7 * 10.4 *
 beste Teiler 14.8 (12.) 70.4 (19.) 109.3 (17.)
 Trefferlage 0.05 mm links, 0.52 mm hoch
 Streuwert 1.13, horizontal: 0.81, vertikal: 1.38

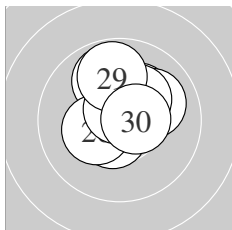

Serie 3:
 9.9 ↑ 10.5 * 10.2 * 10.6 * 10.0 ↗
 10.3 * 10.7 * 10.3 * 9.8 ↑ 10.5 *
 beste Teiler 71.5 (27.) 97.4 (24.) 104.2 (30.)
 Trefferlage 0.27 mm rechts, 0.94 mm hoch
 Streuwert 1.15, horizontal: 1.10, vertikal: 1.19

Unterschrift des Schützen

Ergebnis: **270.6** (257)
 Serien: 89.8 88.9 91.9
 Zähler: 5 14 6 3 2 0 0 0 0 0
 Innenzehner: 3
 weiteste: 1086 (13), 1052 (14), 887 (23)
 beste Teiler 94.2 (18.) 108.6 (15.) 158.2 (3.)
 Trefferlage 0.83 mm rechts, 2.25 mm tief
 Streuwert 3.51, horizontal: 4.32, vertikal: 2.44

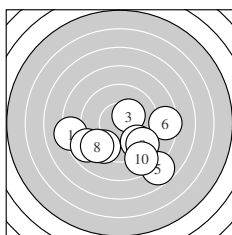
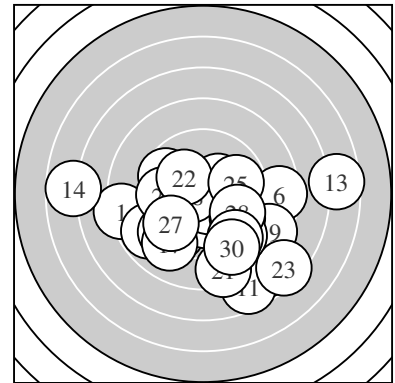

Serie 1:
 8.2 ← 9.4 ↙ 10.3 * 9.6 ↘ 7.8 ↘
 8.5 → 8.8 ↙ 9.2 ↙ 9.3 ↘ 8.7 ↘
 beste Teiler 158.2 (3.) 343.8 (4.) 381.3 (2.)
 Trefferlage 0.47 mm rechts, 2.58 mm tief
 Streuwert 3.36, horizontal: 4.28, vertikal: 2.08

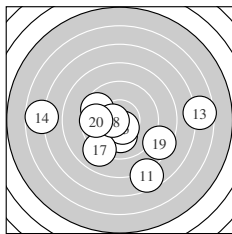

Serie 2:
 7.6 ↘ 10.1 ↓ 6.6 → 6.7 ← 10.5 *
 9.6 ↖ 9.0 ↙ 10.6 * 8.5 ↘ 9.7 ←
 beste Teiler 94.2 (18.) 108.6 (15.) 214.4 (12.)
 Trefferlage 0.00 mm , 1.49 mm tief
 Streuwert 4.51, horizontal: 5.75, vertikal: 2.74

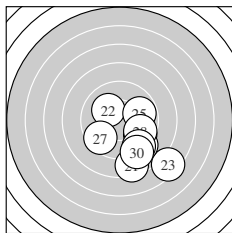

Serie 3:
 8.4 ↓ 10.1 ↖ 7.4 ↘ 9.6 ↘ 9.8 →
 9.2 ↘ 9.5 ↙ 9.7 ↘ 9.2 ↘ 9.0 ↘
 beste Teiler 204.0 (22.) 283.0 (25.) 316.7 (28.)
 Trefferlage 2.01 mm rechts, 2.69 mm tief
 Streuwert 2.53, horizontal: 2.53, vertikal: 2.53

Unterschrift des Schützen

Ergebnis: **312.3** (299)
 Serien: 105.1 104.1 103.1
 Zähler: 29 1 0 0 0 0 0 0 0 0
 Innenzehner: 25
 weiteste: 366 (26), 232 (28), 224 (13)
 beste Teiler 26.9 (15.) 55.1 (10.) 61.5 (1.)
 Trefferlage 0.17 mm rechts, 0.12 mm tief
 Streuwert 1.08, horizontal: 1.08, vertikal: 1.07

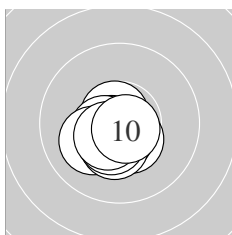
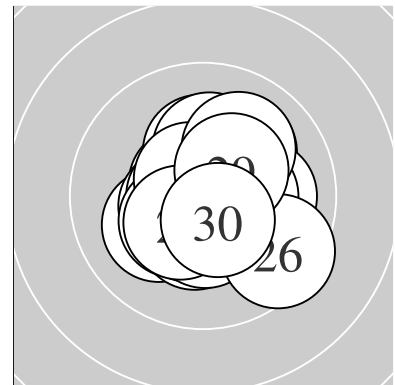

Serie 1:
 10.7 * 10.5 * 10.7 * 10.5 * 10.1 ↙
 10.6 * 10.4 * 10.4 * 10.5 * 10.7 *
 beste Teiler 55.1 (10.) 61.5 (1.) 69.0 (3.)
 Trefferlage 0.42 mm links, 0.72 mm tief
 Streuwert 0.63, horizontal: 0.69, vertikal: 0.56

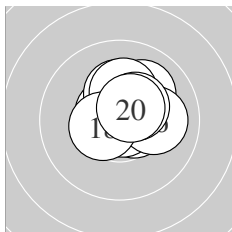

Serie 2:
 10.6 * 10.6 * 10.1 ↗ 10.3 * 10.8 *
 10.1 → 10.2 * 10.5 * 10.4 * 10.5 *
 beste Teiler 26.9 (15.) 83.8 (11.) 97.9 (12.)
 Trefferlage 0.49 mm rechts, 0.66 mm hoch
 Streuwert 0.94, horizontal: 1.00, vertikal: 0.87

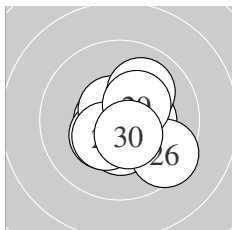

Serie 3:
 10.6 * 10.4 * 10.3 * 10.4 * 10.6 *
 9.5 ↘ 10.4 * 10.0 ↗ 10.4 * 10.5 *
 beste Teiler 78.0 (21.) 81.6 (25.) 111.3 (30.)
 Trefferlage 0.44 mm rechts, 0.30 mm tief
 Streuwert 1.27, horizontal: 1.31, vertikal: 1.23

 Unterschrift des Schützen

Ergebnis: **287.6** (272)
 Serien: 92.5 95.6 99.5
 Zähler: 9 17 2 1 1 0 0 0 0 0
 Innenzehner: 5
 weiteste: 1013 (10), 897 (1), 741 (14)
 beste Teiler 108.5 (28.) 124.3 (29.) 170.5 (27.)
 Trefferlage 1.66 mm links, 0.39 mm tief
 Streuwert 2.61, horizontal: 3.18, vertikal: 1.88

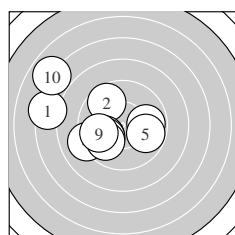
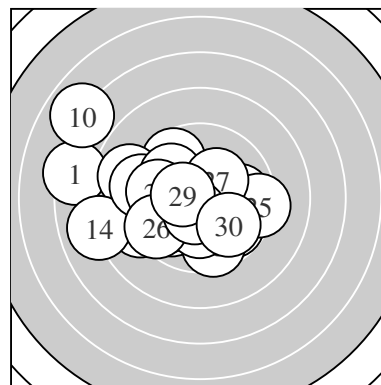

Serie 1:
 7.4 ↙ 9.7 ↘ 9.9 → 9.1 ↙ 9.8 ↘
 10.0 ↙ 10.0 ↙ 9.9 ↙ 9.8 ↙ 6.9 ↘
 beste Teiler 236.4 (6.) 244.2 (7.) 273.8 (8.)
 Trefferlage 2.65 mm links, 0.21 mm hoch
 Streuwert 3.23, horizontal: 3.83, vertikal: 2.49

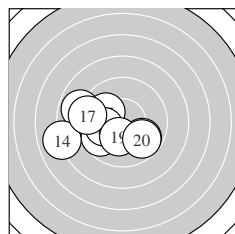

Serie 2:
 8.9 ↙ 9.8 ← 9.7 ↙ 8.0 ← 10.0 ↘
 10.1 ← 9.3 ← 9.8 ↘ 10.2 * 9.8 ↘
 beste Teiler 176.8 (19.) 224.5 (16.) 228.7 (15.)
 Trefferlage 2.18 mm links, 0.68 mm tief
 Streuwert 2.32, horizontal: 2.97, vertikal: 1.41

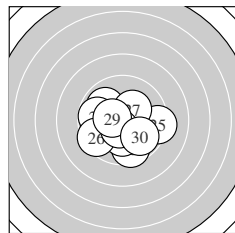

Serie 3:
 9.9 ↘ 9.8 ← 9.6 ↓ 10.2 * 9.3 →
 9.5 ↙ 10.3 * 10.5 * 10.5 * 9.9 ↘
 beste Teiler 108.5 (28.) 124.3 (29.) 170.5 (27.)
 Trefferlage 0.14 mm links, 0.72 mm tief
 Streuwert 1.97, horizontal: 2.28, vertikal: 1.60

Unterschrift des Schützen

Meyton Elektronik

Ergebnis: **308.7** (292)
 Serien: 103.2 100.2 105.3
 Zähler: 22 8 0 0 0 0 0 0 0 0
 Innenzehner: 18
 weiteste: 396 (11), 329 (16), 313 (18)
 beste Teiler 19.2 (29.) 40.0 (14.) 60.3 (1.)
 Trefferlage 0.91 mm links, 0.69 mm hoch
 Streuwert 1.13, horizontal: 1.43, vertikal: 0.72

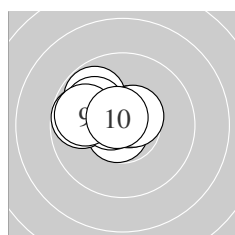
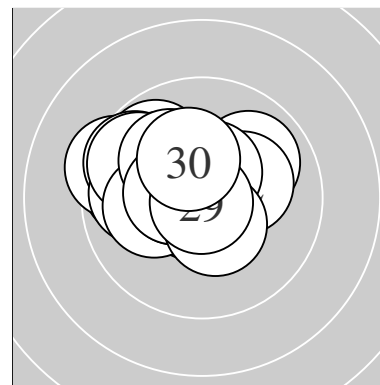

Serie 1:
 10.7 * 9.8 ← 10.6 * 10.6 * 9.8 ↘
 10.6 * 10.0 ↘ 10.6 * 9.8 ← 10.7 *
 beste Teiler 60.3 (1.) 68.8 (10.) 76.4 (3.)
 Trefferlage 1.08 mm links, 0.70 mm hoch
 Streuwert 1.01, horizontal: 1.28, vertikal: 0.63

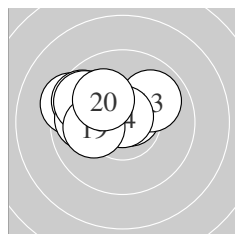

Serie 2:
 9.4 ↘ 10.7 * 9.9 ↗ 10.8 * 10.0 ↘
 9.6 ↘ 9.9 ← 9.7 ↘ 10.1 ← 10.1 ↘
 beste Teiler 40.0 (14.) 70.7 (12.) 210.9 (19.)
 Trefferlage 1.48 mm links, 0.97 mm hoch
 Streuwert 1.37, horizontal: 1.80, vertikal: 0.72

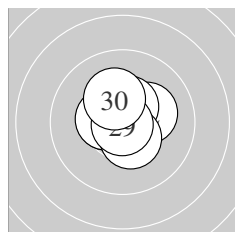

Serie 3:
 10.7 * 10.2 * 10.7 * 10.7 * 10.5 *
 10.5 * 10.5 * 10.4 * 10.9 * 10.2 *
 beste Teiler 19.2 (29.) 64.4 (24.) 65.9 (21.)
 Trefferlage 0.17 mm links, 0.39 mm hoch
 Streuwert 0.82, horizontal: 0.88, vertikal: 0.75

Unterschrift des Schützen

Meyton Elektronik

Ergebnis: **305.4** (293)
 Serien: 100.8 102.1 102.5
 Zähler: 24 5 1 0 0 0 0 0 0 0
 Innenzehner: 15
 weiteste: 538 (27), 349 (5), 338 (3)
 beste Teiler 48.0 (19.) 51.1 (22.) 51.3 (26.)
 Trefferlage 0.38 mm rechts, 0.27 mm tief
 Streuwert 1.54, horizontal: 1.12, vertikal: 1.86

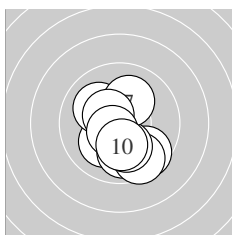
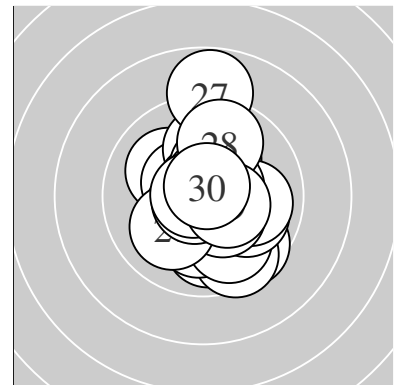

Serie 1:
 10.1 ↙ 9.9 ↓ 9.6 ↘ 10.1 ↖ 9.6 ↘
 10.1 ↓ 10.1 ↑ 10.5 * 10.6 * 10.2 *
 beste Teiler 94.9 (9.) 121.2 (8.) 188.9 (10.)
 Trefferlage 0.10 mm rechts, 1.03 mm tief
 Streuwert 1.55, horizontal: 1.31, vertikal: 1.76

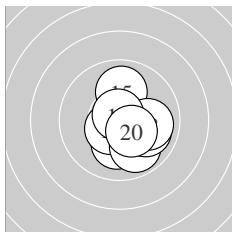

Serie 2:
 10.2 * 10.2 * 10.1 ↓ 10.5 * 10.0 ↑
 9.9 ↘ 10.0 ↘ 10.0 → 10.8 * 10.4 *
 beste Teiler 48.0 (19.) 108.9 (14.) 140.8 (20.)
 Trefferlage 0.86 mm rechts, 0.69 mm tief
 Streuwert 1.24, horizontal: 1.11, vertikal: 1.37

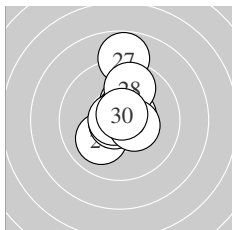

Serie 3:
 10.0 ↙ 10.7 * 10.3 * 10.5 * 10.6 *
 10.7 * 8.8 ↑ 9.8 ↑ 10.4 * 10.7 *
 beste Teiler 51.1 (22.) 51.3 (26.) 54.7 (30.)
 Trefferlage 0.19 mm rechts, 0.90 mm hoch
 Streuwert 1.51, horizontal: 0.85, vertikal: 1.96

Unterschrift des Schützen

Ergebnis: **307.7** (294)
 Serien: 103.3 103.5 100.9
 Zähler: 24 6 0 0 0 0 0 0 0 0
 Innenzehner: 22
 weiteste: 421 (22), 387 (30), 358 (26)
 beste Teiler 2.2 (19.) 62.1 (28.) 74.9 (6.)
 Trefferlage 0.12 mm links, 0.26 mm tief
 Streuwert 1.42, horizontal: 1.35, vertikal: 1.49

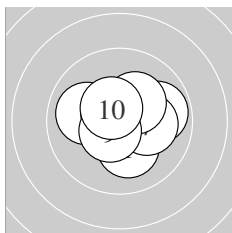
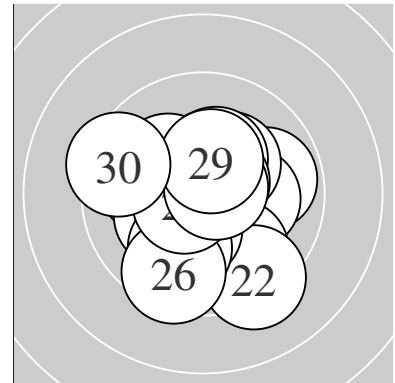

Serie 1:
 10.2 * 10.5 * 9.9 → 10.4 * 10.0 ←
 10.7 * 10.2 * 10.3 * 10.6 * 10.5 *
 beste Teiler 74.9 (6.) 97.5 (9.) 110.1 (2.)
 Trefferlage 0.20 mm rechts, 0.27 mm hoch
 Streuwert 1.25, horizontal: 1.50, vertikal: 0.94

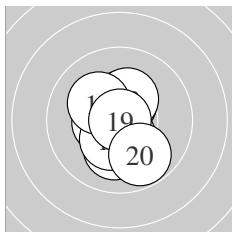

Serie 2:
 10.4 * 10.5 * 10.3 * 10.4 * 10.5 *
 10.1 ↓ 10.4 * 10.2 * 10.9 * 9.8 ↘
 beste Teiler 2.2 (19.) 120.2 (15.) 123.3 (12.)
 Trefferlage 0.06 mm links, 0.20 mm tief
 Streuwert 1.23, horizontal: 0.88, vertikal: 1.50

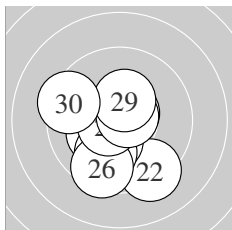

Serie 3:
 10.6 * 9.3 ↘ 10.3 * 10.2 * 9.9 ↓
 9.5 ↓ 10.6 * 10.7 * 10.4 * 9.4 ←
 beste Teiler 62.1 (28.) 81.0 (21.) 87.4 (27.)
 Trefferlage 0.51 mm links, 0.85 mm tief
 Streuwert 1.70, horizontal: 1.58, vertikal: 1.81

Unterschrift des Schützen

Ergebnis: **304.2** (292)
 Serien: 103.7 97.7 102.8
 Zähler: 23 6 1 0 0 0 0 0 0 0
 Innenzehner: 18
 weiteste: 513 (18), 432 (14), 407 (13)
 beste Teiler 48.0 (9.) 52.7 (1.) 59.6 (4.)
 Trefferlage 0.33 mm rechts, 0.65 mm hoch
 Streuwert 1.60, horizontal: 1.99, vertikal: 1.06

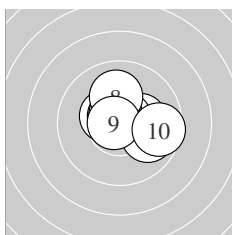
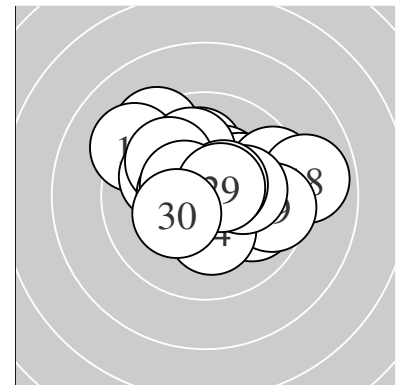

Serie 1:
 10.7 * 10.3 * 10.4 * 10.7 * 10.6 *
 10.6 * 9.9 ↘ 10.1 ↑ 10.8 * 9.6 →
 beste Teiler 48.0 (9.) 52.7 (1.) 59.6 (4.)
 Trefferlage 0.49 mm rechts, 0.37 mm hoch
 Streuwert 1.20, horizontal: 1.47, vertikal: 0.86

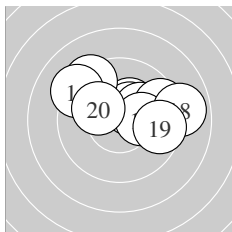

Serie 2:
 10.3 * 10.4 * 9.3 ↘ 9.2 ↘ 10.2 *
 9.5 → 10.2 * 8.9 → 9.6 → 10.1 ↘
 beste Teiler 128.9 (12.) 156.4 (11.) 184.2 (17.)
 Trefferlage 0.93 mm rechts, 1.15 mm hoch
 Streuwert 2.11, horizontal: 2.79, vertikal: 1.08

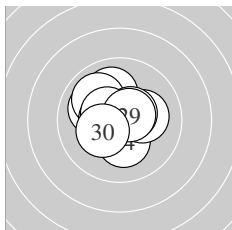

Serie 3:
 10.0 ↘ 10.0 ↑ 10.0 ↘ 10.2 * 10.5 *
 10.2 * 10.5 * 10.5 * 10.6 * 10.3 *
 beste Teiler 89.4 (29.) 109.0 (27.) 118.5 (28.)
 Trefferlage 0.43 mm links, 0.42 mm hoch
 Streuwert 1.25, horizontal: 1.34, vertikal: 1.15

Unterschrift des Schützen

Ergebnis: **303.0** (291)
 Serien: 101.6 99.9 101.5
 Zähler: 22 7 1 0 0 0 0 0 0 0
 Innenzehner: 16
 weiteste: 737 (16), 385 (4), 358 (20)
 beste Teiler 24.0 (5.) 83.8 (7.) 90.7 (19.)
 Trefferlage 0.75 mm links, 0.13 mm hoch
 Streuwert 1.70, horizontal: 2.16, vertikal: 1.07

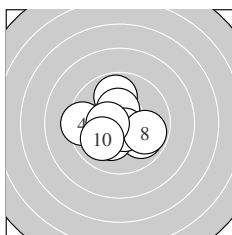
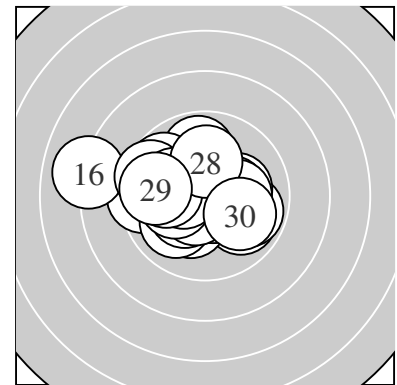

Serie 1:
 9.9 ↑ 9.9 ↘ 10.2 * 9.4 ← 10.9 *
 10.4 * 10.6 * 9.8 ↗ 10.5 * 10.0 ↙
 beste Teiler 24.0 (5.) 83.8 (7.) 124.1 (9.)
 Trefferlage 0.30 mm links, 0.19 mm tief
 Streuwert 1.65, horizontal: 1.88, vertikal: 1.39

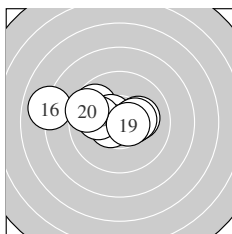

Serie 2:
 10.2 * 9.7 ↖ 10.5 * 10.6 * 10.4 *
 8.0 ← 10.3 * 10.1 ← 10.6 * 9.5 ↖
 beste Teiler 90.7 (19.) 100.8 (14.) 108.7 (13.)
 Trefferlage 1.14 mm links, 0.55 mm hoch
 Streuwert 2.07, horizontal: 2.84, vertikal: 0.70

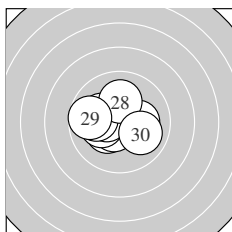

Serie 3:
 10.3 * 10.5 * 10.1 ↖ 10.2 * 10.2 *
 10.4 * 10.0 ← 10.1 ↑ 9.7 ← 10.0 ↘
 beste Teiler 101.0 (22.) 134.6 (26.) 159.6 (21.)
 Trefferlage 0.82 mm links, 0.05 mm hoch
 Streuwert 1.41, horizontal: 1.74, vertikal: 0.97

Unterschrift des Schützen

Ergebnis: **308.7** (297)
 Serien: 103.7 102.2 102.8
 Zähler: 27 3 0 0 0 0 0 0 0 0
 Innenzehner: 24
 weiteste: 458 (8), 313 (21), 312 (19)
 beste Teiler 49.7 (9.) 60.4 (2.) 63.5 (10.)
 Trefferlage 0.27 mm links, 0.81 mm tief
 Streuwert 1.17, horizontal: 1.36, vertikal: 0.95

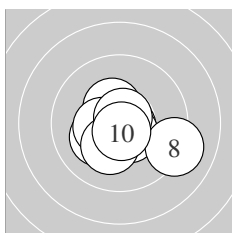
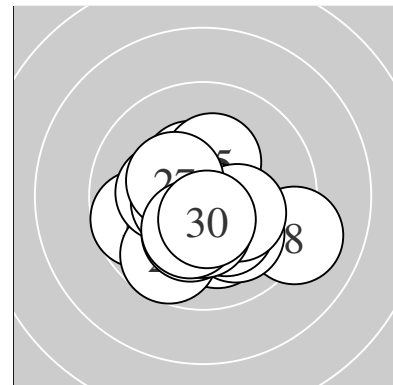

Serie 1:
 10.2 * 10.7 * 10.4 * 10.5 * 10.7 *
 10.4 * 10.2 * 9.1 ↘ 10.8 * 10.7 *
 beste Teiler 49.7 (9.) 60.4 (2.) 63.5 (10.)
 Trefferlage 0.11 mm rechts, 0.53 mm tief
 Streuwert 1.32, horizontal: 1.63, vertikal: 0.91

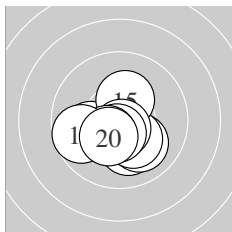

Serie 2:
 10.1 ↘ 10.0 ↘ 10.0 ← 10.2 * 10.3 *
 10.7 * 10.5 * 10.4 * 9.7 ← 10.3 *
 beste Teiler 65.7 (16.) 101.9 (17.) 146.2 (18.)
 Trefferlage 0.33 mm links, 0.95 mm tief
 Streuwert 1.21, horizontal: 1.42, vertikal: 0.97

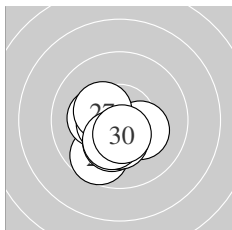

Serie 3:
 9.7 ↙ 10.5 * 10.2 * 10.2 * 10.2 *
 10.5 * 10.4 * 10.3 * 10.3 * 10.5 *
 beste Teiler 109.4 (30.) 111.3 (26.) 118.2 (22.)
 Trefferlage 0.59 mm links, 0.96 mm tief
 Streuwert 0.99, horizontal: 0.99, vertikal: 0.99

Unterschrift des Schützen

Ergebnis: **306.6** (294)
 Serien: 102.5 104.2 99.9
 Zähler: 25 4 1 0 0 0 0 0 0 0
 Innenzehner: 22
 weiteste: 504 (30), 420 (26), 364 (4)
 beste Teiler 23.7 (20.) 54.8 (24.) 65.7 (18.)
 Trefferlage 0.51 mm links, 0.01 mm hoch
 Streuwert 1.48, horizontal: 1.50, vertikal: 1.45

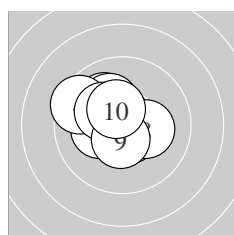
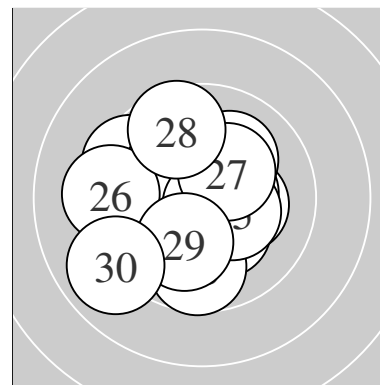

Serie 1:
 10.2 * 10.0 ↘ 10.2 * 9.5 ↖ 10.6 *
 10.7 * 10.2 * 10.2 * 10.5 * 10.4 *
 beste Teiler 70.0 (6.) 86.4 (5.) 108.0 (9.)
 Trefferlage 0.74 mm links, 0.56 mm hoch
 Streuwert 1.23, horizontal: 1.38, vertikal: 1.07

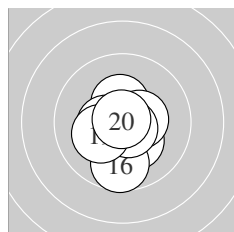

Serie 2:
 10.6 * 10.4 * 10.3 * 10.6 * 10.4 *
 9.7 ↓ 10.4 * 10.7 * 10.2 * 10.9 *
 beste Teiler 23.7 (20.) 65.7 (18.) 77.3 (11.)
 Trefferlage 0.01 mm links, 0.56 mm tief
 Streuwert 1.07, horizontal: 0.92, vertikal: 1.20

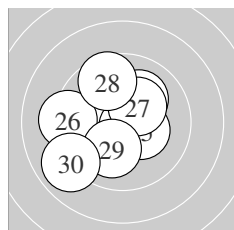

Serie 3:
 10.1 ↗ 10.2 * 10.4 * 10.7 * 10.3 *
 9.3 ← 10.3 * 9.6 ↘ 10.1 ↓ 8.9 ↙
 beste Teiler 54.8 (24.) 144.8 (23.) 152.2 (25.)
 Trefferlage 0.80 mm links, 0.03 mm hoch
 Streuwert 1.95, horizontal: 2.02, vertikal: 1.88

Unterschrift des Schützen

Meyton Elektronik

Ergebnis: **315.2** (297)
 Serien: 106.1 103.4 105.7
 Zähler: 27 3 0 0 0 0 0 0 0 0
 Innenzehner: 27
 weiteste: 351 (16), 294 (26), 280 (11)
 beste Teiler 10.6 (21.) 18.3 (23.) 25.2 (19.)
 Trefferlage 0.03 mm links, 0.15 mm tief
 Streuwert 0.99, horizontal: 1.11, vertikal: 0.85

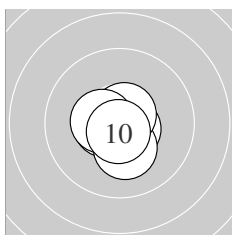
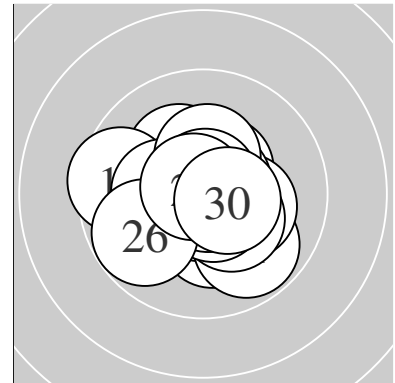

Serie 1:
 10.8 * 10.5 * 10.5 * 10.7 * 10.6 *
 10.8 * 10.3 * 10.7 * 10.5 * 10.7 *
 beste Teiler 26.9 (1.) 46.5 (6.) 53.2 (4.)
 Trefferlage 0.00 mm , 0.35 mm tief
 Streuwert 0.66, horizontal: 0.62, vertikal: 0.69

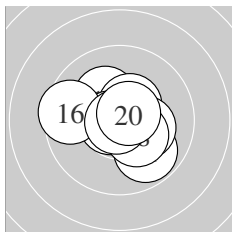

Serie 2:
 9.8 ↘ 10.7 * 10.2 * 10.5 * 10.7 *
 9.5 ← 10.2 * 10.3 * 10.9 * 10.6 *
 beste Teiler 25.2 (19.) 58.1 (12.) 66.4 (15.)
 Trefferlage 0.12 mm rechts, 0.08 mm tief
 Streuwert 1.34, horizontal: 1.57, vertikal: 1.05

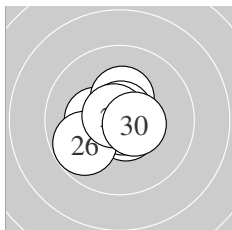

Serie 3:
 10.9 * 10.6 * 10.9 * 10.3 * 10.8 *
 9.8 ↙ 10.3 * 10.8 * 10.8 * 10.5 *
 beste Teiler 10.6 (21.) 18.3 (23.) 29.7 (25.)
 Trefferlage 0.23 mm links, 0.02 mm tief
 Streuwert 0.93, horizontal: 1.03, vertikal: 0.81

Unterschrift des Schützen

Ergebnis: **301.6** (284)
 Serien: 99.1 100.3 102.2
 Zähler: 15 14 1 0 0 0 0 0 0 0
 Innenzehner: 13
 weiteste: 584 (4), 382 (7), 370 (2)
 beste Teiler 16.2 (28.) 66.6 (5.) 70.2 (26.)
 Trefferlage 0.46 mm links, 0.69 mm tief
 Streuwert 1.74, horizontal: 1.60, vertikal: 1.87

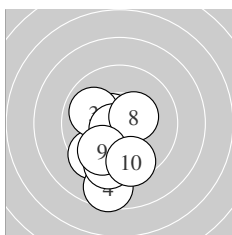
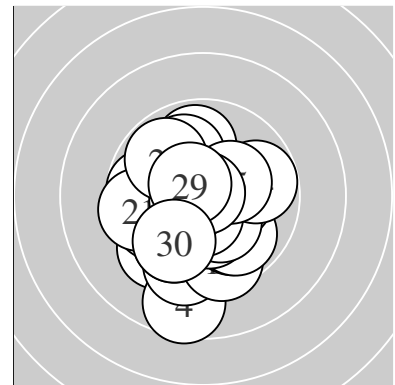

Serie 1:
 10.6 * 9.5 ↘ 9.9 ↖ 8.6 ↓ 10.7 *
 10.7 * 9.4 ↓ 10.4 * 9.8 ↘ 9.5 ↓
 beste Teiler 66.6 (5.) 71.4 (6.) 88.1 (1.)
 Trefferlage 0.76 mm links, 1.72 mm tief
 Streuwert 1.80, horizontal: 1.23, vertikal: 2.24

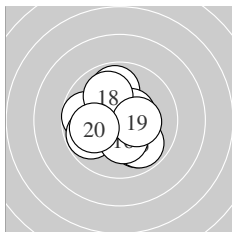

Serie 2:
 9.9 ↘ 9.9 ↑ 9.7 ← 9.8 ↙ 9.9 ↘
 10.3 * 10.5 * 10.0 ↘ 10.3 * 10.0 ←
 beste Teiler 115.1 (17.) 155.7 (19.) 172.1 (16.)
 Trefferlage 0.31 mm links, 0.21 mm tief
 Streuwert 1.76, horizontal: 1.83, vertikal: 1.68

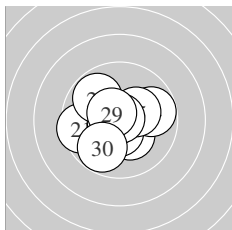

Serie 3:
 9.5 ← 10.3 * 10.5 * 9.8 → 10.3 *
 10.7 * 9.8 ↘ 10.9 * 10.6 * 9.8 ↘
 beste Teiler 16.2 (28.) 70.2 (26.) 96.2 (29.)
 Trefferlage 0.31 mm links, 0.15 mm tief
 Streuwert 1.57, horizontal: 1.81, vertikal: 1.28

Unterschrift des Schützen

Ergebnis: **301.9** (288)
 Serien: 101.3 100.3 100.3
 Zähler: 18 12 0 0 0 0 0 0 0 0
 Innenzehner: 14
 weiteste: 415 (6), 376 (20), 365 (25)
 beste Teiler 56.0 (26.) 88.3 (9.) 102.0 (27.)
 Trefferlage 0.58 mm links, 0.49 mm tief
 Streuwert 1.64, horizontal: 1.76, vertikal: 1.52

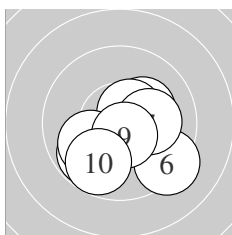
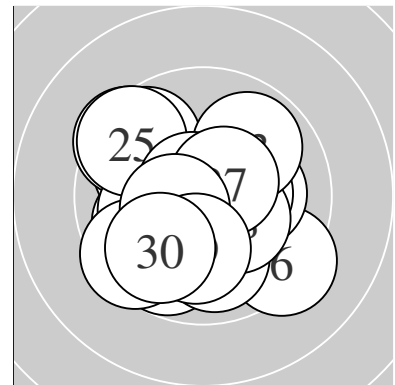

Serie 1:
 10.2 * 10.4 * 10.5 * 10.5 * 9.8 ↙
 9.3 ↘ 10.2 * 10.0 ↙ 10.6 * 9.8 ↙
 beste Teiler 88.3 (9.) 102.5 (4.) 102.9 (3.)
 Trefferlage 0.44 mm rechts, 0.83 mm tief
 Streuwert 1.55, horizontal: 1.75, vertikal: 1.31

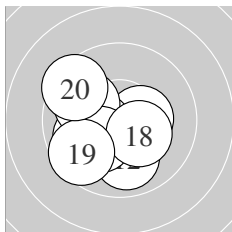

Serie 2:
 9.9 ↙ 9.9 ↓ 10.4 * 10.4 * 10.2 *
 10.0 ↘ 10.2 * 10.3 * 9.6 ↙ 9.4 ↘
 beste Teiler 141.3 (14.) 142.3 (13.) 160.8 (18.)
 Trefferlage 1.11 mm links, 0.62 mm tief
 Streuwert 1.53, horizontal: 1.62, vertikal: 1.43

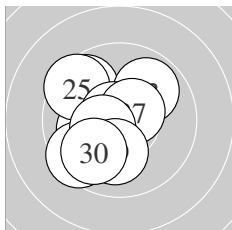

Serie 3:
 9.7 ↘ 10.1 ← 9.9 ↗ 9.5 ↙ 9.5 ↘
 10.7 * 10.5 * 10.4 * 10.1 ↓ 9.9 ↙
 beste Teiler 56.0 (26.) 102.0 (27.) 127.0 (28.)
 Trefferlage 1.10 mm links, 0.04 mm tief
 Streuwert 1.69, horizontal: 1.57, vertikal: 1.81

Unterschrift des Schützen

Ergebnis: **306.8** (293)
 Serien: 102.6 102.6 101.6
 Zähler: 23 7 0 0 0 0 0 0 0 0
 Innenzehner: 18
 weiteste: 344 (19), 309 (26), 296 (3)
 beste Teiler 7.0 (1.) 75.3 (13.) 83.3 (15.)
 Trefferlage 0.02 mm links, 0.01 mm tief
 Streuwert 1.43, horizontal: 1.58, vertikal: 1.25

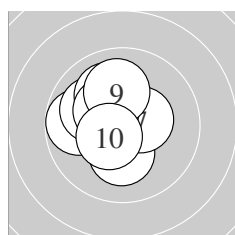
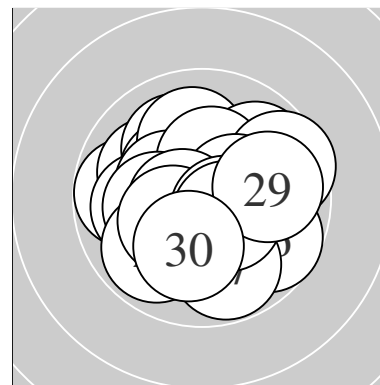

Serie 1:
 10.9 * 10.2 * 9.8 ← 10.0 ↖ 10.1 ↗
 10.3 * 10.4 * 10.4 * 10.0 ↑ 10.5 *
 beste Teiler 7.0 (1.) 119.2 (10.) 126.5 (7.)
 Trefferlage 0.80 mm links, 0.57 mm hoch
 Streuwert 1.20, horizontal: 1.14, vertikal: 1.26

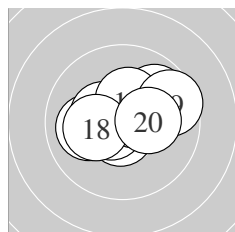

Serie 2:
 10.0 ← 9.9 ↗ 10.7 * 10.4 * 10.6 *
 10.6 * 10.3 * 10.2 * 9.6 → 10.3 *
 beste Teiler 75.3 (13.) 83.3 (15.) 100.2 (16.)
 Trefferlage 0.20 mm rechts, 0.37 mm hoch
 Streuwert 1.41, horizontal: 1.80, vertikal: 0.86

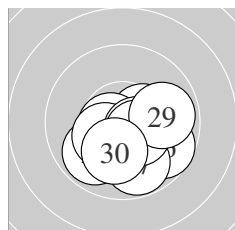

Serie 3:
 10.4 * 9.9 ↘ 10.6 * 10.3 * 10.5 *
 9.7 ↘ 9.8 ↓ 10.4 * 9.9 → 10.1 ↓
 beste Teiler 84.1 (23.) 108.7 (25.) 126.0 (28.)
 Trefferlage 0.52 mm rechts, 0.99 mm tief
 Streuwert 1.33, horizontal: 1.56, vertikal: 1.05

Unterschrift des Schützen

Meyton Elektronik

Ergebnis: **304.0** (289)
 Serien: 101.3 102.1 100.6
 Zähler: 20 9 1 0 0 0 0 0 0 0
 Innenzehner: 14
 weiteste: 575 (25), 390 (20), 304 (26)
 beste Teiler 61.3 (6.) 69.4 (14.) 70.7 (28.)
 Trefferlage 0.06 mm links, 0.58 mm tief
 Streuwert 1.62, horizontal: 1.90, vertikal: 1.27

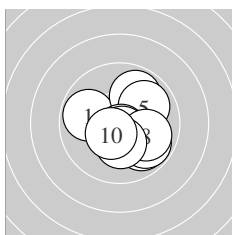
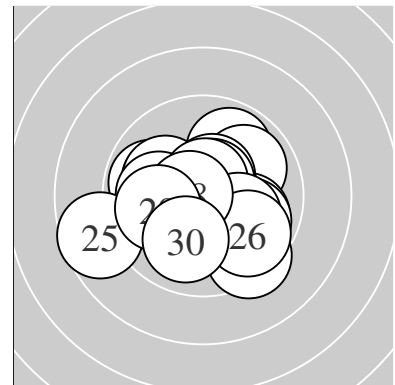

Serie 1:
 9.8 ↙ 9.9 ↘ 9.9 ↗ 9.8 ↘ 9.9 ↗
 10.7 * 10.6 * 9.9 ↘ 10.3 * 10.5 *
 beste Teiler 61.3 (6.) 80.0 (7.) 116.5 (10.)
 Trefferlage 0.69 mm rechts, 0.40 mm tief
 Streuwert 1.53, horizontal: 1.61, vertikal: 1.44

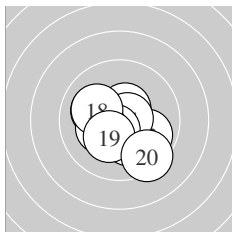

Serie 2:
 10.2 * 10.5 * 9.9 ↘ 10.7 * 10.1 ↖
 10.6 * 10.3 * 10.1 ↖ 10.3 * 9.4 ↘
 beste Teiler 69.4 (14.) 97.5 (16.) 110.0 (12.)
 Trefferlage 0.02 mm links, 0.62 mm tief
 Streuwert 1.49, horizontal: 1.63, vertikal: 1.34

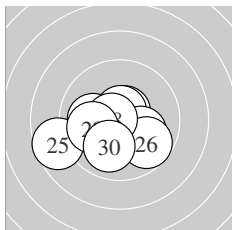

Serie 3:
 10.0 ← 10.6 * 10.6 * 10.1 ↘ 8.7 ←
 9.7 ↘ 10.2 * 10.7 * 10.0 ← 10.0 ↓
 beste Teiler 70.7 (28.) 76.6 (23.) 86.0 (22.)
 Trefferlage 0.85 mm links, 0.72 mm tief
 Streuwert 1.78, horizontal: 2.24, vertikal: 1.13

Unterschrift des Schützen

Ergebnis: **306.8** (295)
 Serien: 101.0 103.3 102.5
 Zähler: 26 3 1 0 0 0 0 0 0 0
 Innenzehner: 20
 weiteste: 638 (3), 332 (19), 323 (27)
 beste Teiler 30.0 (25.) 74.4 (18.) 81.0 (28.)
 Trefferlage 0.08 mm rechts, 0.63 mm tief
 Streuwert 1.45, horizontal: 1.13, vertikal: 1.71

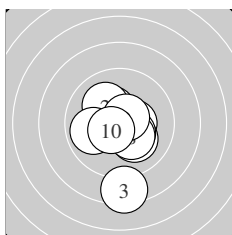
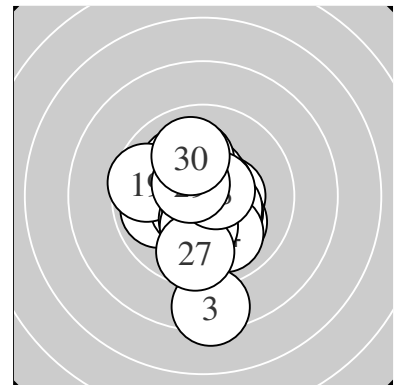

Serie 1:
 10.4 * 10.1 ↘ 8.4 ↓ 10.4 * 10.1 ↘
 10.3 * 9.9 ← 10.3 * 10.6 * 10.5 *
 beste Teiler 82.2 (9.) 104.4 (10.) 134.0 (4.)
 Trefferlage 0.07 mm rechts, 0.79 mm tief
 Streuwert 1.84, horizontal: 1.35, vertikal: 2.23

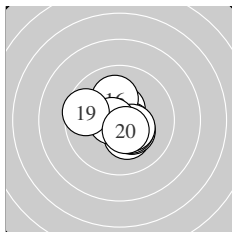

Serie 2:
 10.5 * 10.3 * 10.3 * 10.5 * 10.4 *
 10.1 ↑ 10.4 * 10.7 * 9.6 ← 10.5 *
 beste Teiler 74.4 (18.) 102.5 (14.) 107.0 (11.)
 Trefferlage 0.13 mm rechts, 0.18 mm tief
 Streuwert 1.25, horizontal: 1.36, vertikal: 1.13

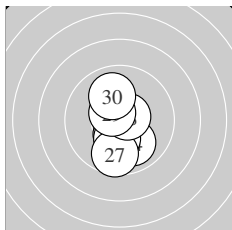

Serie 3:
 10.4 * 10.2 * 10.0 ↓ 10.0 ↘ 10.8 *
 10.2 * 9.7 ↓ 10.6 * 10.6 * 10.0 ↑
 beste Teiler 30.0 (25.) 81.0 (28.) 99.7 (29.)
 Trefferlage 0.06 mm rechts, 0.90 mm tief
 Streuwert 1.29, horizontal: 0.70, vertikal: 1.68

Unterschrift des Schützen

Ergebnis: **301.8** (289)
 Serien: 101.7 100.1 100.0
 Zähler: 21 7 2 0 0 0 0 0 0 0
 Innenzehner: 14
 weiteste: 557 (17), 510 (5), 456 (30)
 beste Teiler 46.0 (3.) 52.6 (12.) 85.2 (10.)
 Trefferlage 0.31 mm rechts, 0.80 mm tief
 Streuwert 1.77, horizontal: 2.26, vertikal: 1.10

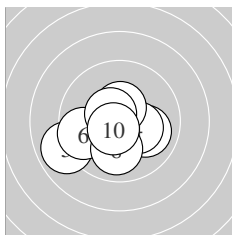
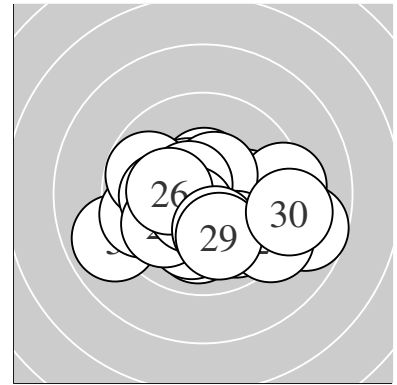

Serie 1:
 10.4 * 10.0 → 10.8 * 10.3 * 8.9 ←
 9.6 ← 10.5 * 10.0 ↓ 10.6 * 10.6 *
 beste Teiler 46.0 (3.) 85.2 (10.) 100.8 (9.)
 Trefferlage 0.55 mm links, 0.76 mm tief
 Streuwert 1.62, horizontal: 2.00, vertikal: 1.12

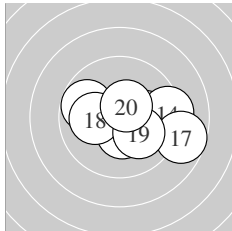

Serie 2:
 10.4 * 10.7 * 10.1 → 9.3 → 10.4 *
 9.8 ← 8.7 → 10.1 ← 10.1 ↘ 10.5 *
 beste Teiler 52.6 (12.) 113.0 (20.) 137.9 (15.)
 Trefferlage 0.96 mm rechts, 0.31 mm tief
 Streuwert 1.92, horizontal: 2.53, vertikal: 1.00

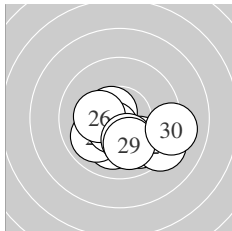

Serie 3:
 9.9 ↘ 10.1 ↓ 10.6 * 9.9 ↙ 10.6 *
 10.3 * 9.3 ↘ 10.2 * 10.0 ↓ 9.1 →
 beste Teiler 87.0 (23.) 100.6 (25.) 174.5 (26.)
 Trefferlage 0.54 mm rechts, 1.33 mm tief
 Streuwert 1.68, horizontal: 2.15, vertikal: 1.01

Unterschrift des Schützen

Ergebnis: **306.8** (294)
 Serien: 101.1 104.0 101.7
 Zähler: 24 6 0 0 0 0 0 0 0 0
 Innenzehner: 17
 weiteste: 385 (8), 376 (26), 321 (3)
 beste Teiler 24.0 (12.) 40.3 (9.) 49.2 (20.)
 Trefferlage 0.07 mm rechts, 0.04 mm tief
 Streuwert 1.49, horizontal: 1.64, vertikal: 1.33

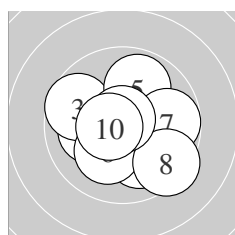
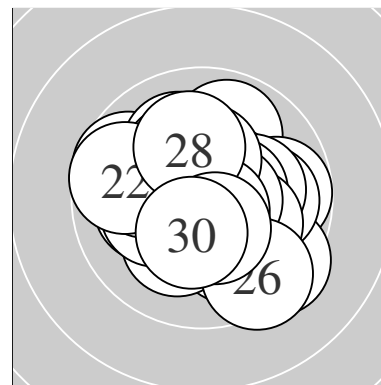

Serie 1:
 10.0 ↘ 10.1 ← 9.7 ↖ 10.6 * 9.9 ↗
 10.2 * 9.8 → 9.4 ↘ 10.8 * 10.6 *
 beste Teiler 40.3 (9.) 89.5 (10.) 96.0 (4.)
 Trefferlage 0.04 mm rechts, 0.30 mm tief
 Streuwert 1.76, horizontal: 1.97, vertikal: 1.52

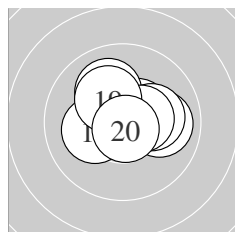

Serie 2:
 10.5 * 10.9 * 10.6 * 10.1 ↗ 10.0 →
 10.2 * 10.2 * 10.5 * 10.2 * 10.8 *
 beste Teiler 24.0 (12.) 49.2 (20.) 85.4 (13.)
 Trefferlage 0.19 mm rechts, 0.40 mm hoch
 Streuwert 1.15, horizontal: 1.41, vertikal: 0.82

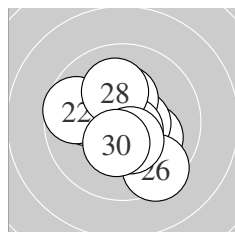

Serie 3:
 10.0 ↖ 9.7 ↖ 10.1 ↘ 10.6 * 10.3 *
 9.4 ↘ 10.7 * 10.1 ↗ 10.4 * 10.4 *
 beste Teiler 70.8 (27.) 99.4 (24.) 132.6 (29.)
 Trefferlage 0.01 mm links, 0.22 mm tief
 Streuwert 1.60, horizontal: 1.66, vertikal: 1.53

Unterschrift des Schützen

Meyton Elektronik

Ergebnis: **306.2** (293)
 Serien: 104.0 101.5 100.7
 Zähler: 23 7 0 0 0 0 0 0 0 0
 Innenzehner: 17
 weiteste: 475 (24), 368 (16), 331 (29)
 beste Teiler 8.0 (8.) 16.1 (26.) 61.0 (1.)
 Trefferlage 0.57 mm links, 0.39 mm hoch
 Streuwert 1.42, horizontal: 1.31, vertikal: 1.53

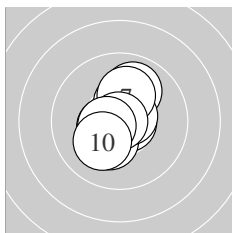
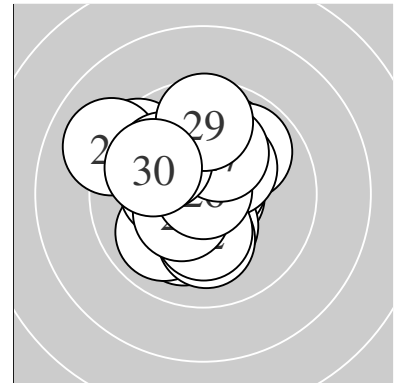

Serie 1:
 10.7 * 10.3 * 10.5 * 10.4 * 9.9 ↗
 10.6 * 10.1 ↗ 10.9 * 10.5 * 10.1 ↘
 beste Teiler 8.0 (8.) 61.0 (1.) 78.3 (6.)
 Trefferlage 0.12 mm links, 0.21 mm hoch
 Streuwert 1.11, horizontal: 0.85, vertikal: 1.32

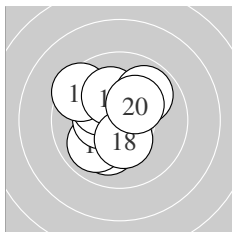

Serie 2:
 10.1 ↘ 9.9 ↘ 10.6 * 10.4 * 10.2 *
 9.5 ↘ 10.2 * 10.4 * 9.9 ↗ 10.3 *
 beste Teiler 98.9 (13.) 137.0 (14.) 150.0 (18.)
 Trefferlage 0.61 mm links, 0.39 mm hoch
 Streuwert 1.52, horizontal: 1.44, vertikal: 1.60

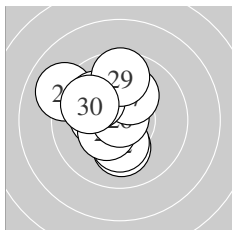

Serie 3:
 10.1 ↓ 10.3 * 10.3 * 9.1 ↘ 10.4 *
 10.9 * 10.1 ↗ 10.0 ↘ 9.6 ↑ 9.9 ↘
 beste Teiler 16.1 (26.) 131.1 (25.) 162.3 (23.)
 Trefferlage 0.98 mm links, 0.57 mm hoch
 Streuwert 1.65, horizontal: 1.52, vertikal: 1.77

Unterschrift des Schützen

Ergebnis: **301.0** (291)
 Serien: 97.3 101.4 102.3
 Zähler: 21 9 0 0 0 0 0 0 0 0
 Innenzehner: 14
 weiteste: 491 (8), 446 (1), 422 (10)
 beste Teiler 65.5 (18.) 91.3 (25.) 118.0 (16.)
 Trefferlage 0.48 mm rechts, 0.70 mm tief
 Streuwert 1.76, horizontal: 1.42, vertikal: 2.04

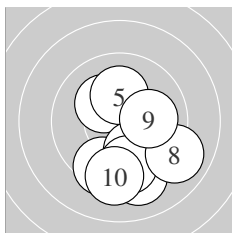
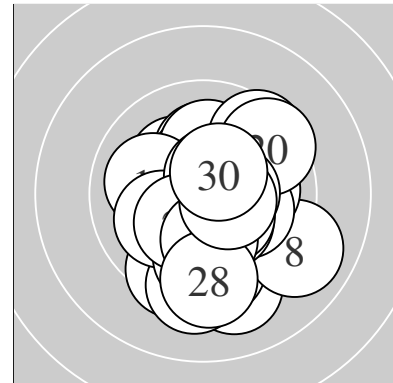

Serie 1:
 9.2 ↓ 9.5 ↓ 10.2 * 10.2 * 10.2 *
 10.0 ↓ 9.6 ↓ 9.0 ↘ 10.1 → 9.3 ↓
 beste Teiler 178.8 (3.) 181.2 (4.) 200.0 (5.)
 Trefferlage 0.64 mm rechts, 1.47 mm tief
 Streuwert 2.15, horizontal: 1.69, vertikal: 2.53

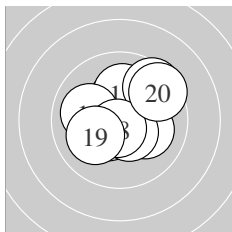

Serie 2:
 10.4 * 10.1 ↑ 10.5 * 10.1 ↘ 10.0 ←
 10.5 * 9.5 ↗ 10.7 * 10.1 ↙ 9.5 ↗
 beste Teiler 65.5 (18.) 118.0 (16.) 121.6 (13.)
 Trefferlage 0.29 mm rechts, 0.45 mm hoch
 Streuwert 1.63, horizontal: 1.76, vertikal: 1.49

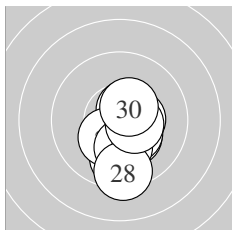

Serie 3:
 10.3 * 10.4 * 9.8 ↓ 10.4 * 10.6 *
 10.3 * 10.1 ↓ 9.4 ↓ 10.5 * 10.5 *
 beste Teiler 91.3 (25.) 119.1 (29.) 124.0 (30.)
 Trefferlage 0.52 mm rechts, 1.09 mm tief
 Streuwert 1.22, horizontal: 0.69, vertikal: 1.58

Unterschrift des Schützen

Ergebnis: **289.8** (278)
 Serien: 96.1 96.6 97.1
 Zähler: 11 16 3 0 0 0 0 0 0 0
 Innenzehner: 7
 weiteste: 609 (24), 553 (12), 504 (20)
 beste Teiler 126.1 (14.) 133.8 (13.) 141.7 (27.)
 Trefferlage 0.38 mm rechts, 1.28 mm tief
 Streuwert 2.31, horizontal: 2.76, vertikal: 1.74

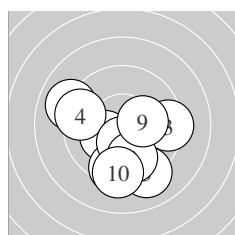
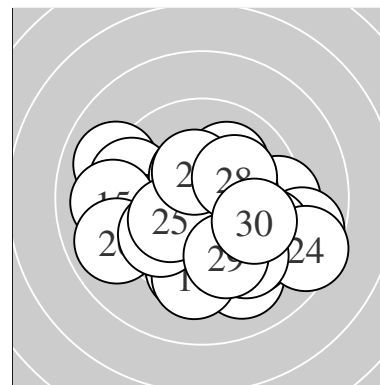

Serie 1:
 9.0 ↖ 10.2 * 9.3 → 9.4 ← 9.1 ↘
 9.4 ↓ 10.4 * 9.8 ↓ 10.2 * 9.3 ↓
 beste Teiler 150.0 (7.) 180.2 (9.) 180.9 (2.)
 Trefferlage 0.23 mm links, 1.42 mm tief
 Streuwert 2.41, horizontal: 2.61, vertikal: 2.19

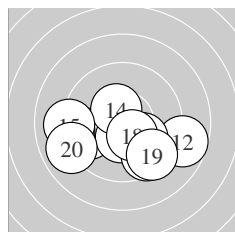

Serie 2:
 9.7 ← 8.7 → 10.4 * 10.4 * 9.1 ←
 9.5 ↘ 10.1 ↘ 10.4 * 9.4 ↘ 8.9 ←
 beste Teiler 126.1 (14.) 133.8 (13.) 143.2 (18.)
 Trefferlage 0.03 mm links, 1.37 mm tief
 Streuwert 2.44, horizontal: 3.24, vertikal: 1.21

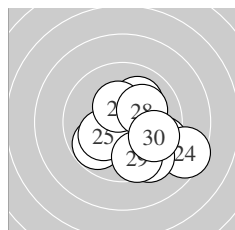

Serie 3:
 9.8 ↙ 9.4 → 10.1 ↗ 8.5 → 10.1 ↙
 9.4 ↘ 10.4 * 10.1 ↗ 9.6 ↓ 9.7 →
 beste Teiler 141.7 (27.) 201.7 (28.) 202.2 (25.)
 Trefferlage 1.40 mm rechts, 1.06 mm tief
 Streuwert 2.10, horizontal: 2.34, vertikal: 1.83

Unterschrift des Schützen

Meyton Elektronik

Ergebnis: **291.4** (276)
 Serien: 99.0 97.5 94.9
 Zähler: 10 16 4 0 0 0 0 0 0 0
 Innenzehner: 9
 weiteste: 736 (24), 610 (12), 581 (28)
 beste Teiler 69.7 (18.) 77.7 (5.) 79.0 (20.)
 Trefferlage 0.49 mm rechts, 0.18 mm tief
 Streuwert 2.51, horizontal: 3.26, vertikal: 1.40

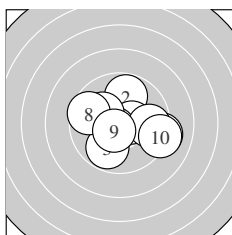
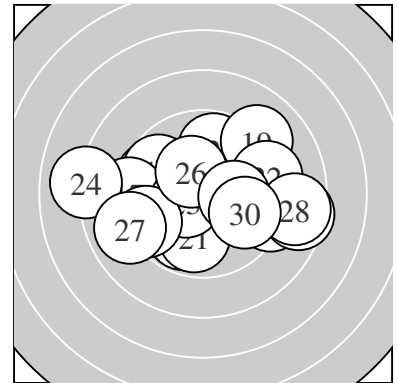

Serie 1:
 9.2 → 9.8 ↑ 9.8 ↓ 10.4 * 10.6 *
 9.7 → 10.1 ↖ 9.6 ↖ 10.6 * 9.2 →
 beste Teiler 77.7 (5.) 96.6 (9.) 127.1 (4.)
 Trefferlage 0.61 mm rechts, 0.17 mm tief
 Streuwert 2.11, horizontal: 2.58, vertikal: 1.49

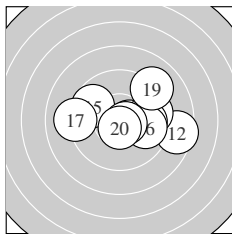

Serie 2:
 10.5 * 8.5 → 9.6 → 9.9 → 9.7 ↖
 9.8 → 9.1 ← 10.7 * 9.1 ↗ 10.6 *
 beste Teiler 69.7 (18.) 79.0 (20.) 101.1 (11.)
 Trefferlage 1.23 mm rechts, 0.21 mm hoch
 Streuwert 2.40, horizontal: 3.13, vertikal: 1.34

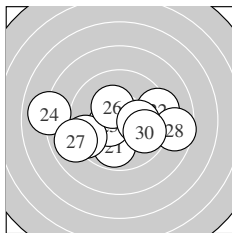

Serie 3:
 9.9 ↓ 9.3 → 10.5 * 8.0 ← 9.4 ←
 10.3 * 8.9 ↖ 8.6 → 10.2 * 9.8 →
 beste Teiler 118.5 (23.) 157.0 (26.) 195.7 (29.)
 Trefferlage 0.35 mm links, 0.61 mm tief
 Streuwert 3.02, horizontal: 4.05, vertikal: 1.37

Unterschrift des Schützen

Ergebnis: **287.4** (270)
 Serien: 96.7 95.5 95.2
 Zähler: 4 22 4 0 0 0 0 0 0 0
 Innenzehner: 3
 weiteste: 622 (16), 570 (3), 548 (25)
 beste Teiler 114.9 (4.) 128.0 (11.) 163.9 (26.)
 Trefferlage 1.18 mm links, 0.43 mm hoch
 Streuwert 2.47, horizontal: 2.96, vertikal: 1.85

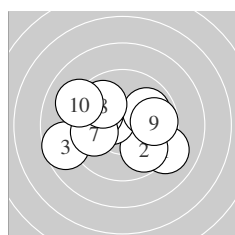
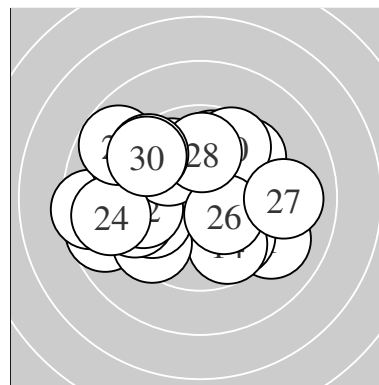

Serie 1:
 9.1 ↘ 9.8 ↘ 8.7 ← 10.5 * 9.9 ↗
 10.0 ↖ 9.9 ← 9.9 ↖ 9.8 → 9.1 ↖
 beste Teiler 114.9 (4.) 242.8 (6.) 257.9 (5.)
 Trefferlage 0.59 mm links, 0.00 mm
 Streuwert 2.56, horizontal: 3.20, vertikal: 1.68

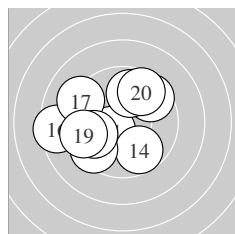

Serie 2:
 10.4 * 9.6 ↗ 9.8 ↑ 9.7 ↘ 9.5 ↖
 8.5 ← 9.2 ↖ 9.8 ← 9.4 ← 9.6 ↗
 beste Teiler 128.0 (11.) 278.9 (13.) 293.4 (18.)
 Trefferlage 1.36 mm links, 0.10 mm hoch
 Streuwert 2.57, horizontal: 2.93, vertikal: 2.15

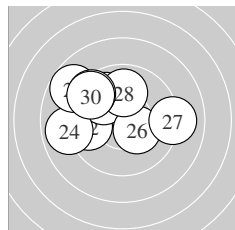

Serie 3:
 9.9 ↖ 9.6 ← 9.9 ↖ 8.9 ← 8.8 ↖
 10.3 * 9.1 → 9.9 ↑ 9.4 ↖ 9.4 ↖
 beste Teiler 163.9 (26.) 253.8 (23.) 257.2 (28.)
 Trefferlage 1.59 mm links, 1.18 mm hoch
 Streuwert 2.39, horizontal: 2.96, vertikal: 1.62

Unterschrift des Schützen

Meyton Elektronik

Ergebnis: **302.7** (289)
 Serien: 98.3 102.3 102.1
 Zähler: 19 11 0 0 0 0 0 0 0 0
 Innenzehner: 13
 weiteste: 417 (20), 389 (2), 359 (10)
 beste Teiler 32.6 (18.) 38.4 (23.) 67.0 (22.)
 Trefferlage 1.50 mm links, 0.22 mm hoch
 Streuwert 1.32, horizontal: 1.41, vertikal: 1.23

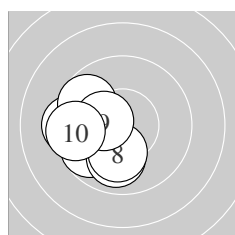
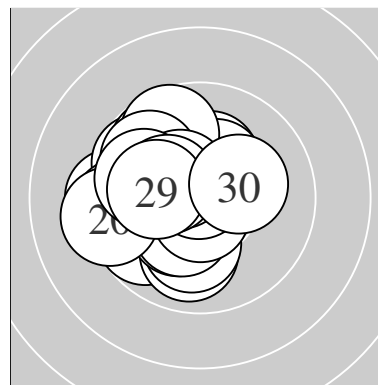

Serie 1:
 9.6 ← 9.4 ← 9.7 ↙ 10.0 ← 10.0 ←
 9.7 ↘ 9.9 ↓ 10.1 ↓ 10.4 * 9.5 ←
 beste Teiler 144.5 (9.) 208.4 (8.) 248.1 (5.)
 Trefferlage 2.32 mm links, 0.41 mm tief
 Streuwert 1.25, horizontal: 1.22, vertikal: 1.28

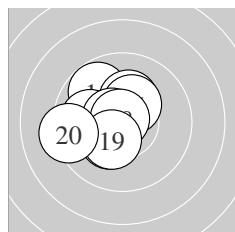

Serie 2:
 9.8 ↘ 10.3 * 10.3 * 10.6 * 10.3 *
 10.0 ← 10.6 * 10.8 * 10.3 * 9.3 ←
 beste Teiler 32.6 (18.) 77.7 (14.) 88.3 (17.)
 Trefferlage 1.08 mm links, 0.25 mm hoch
 Streuwert 1.33, horizontal: 1.42, vertikal: 1.23

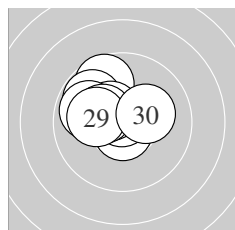

Serie 3:
 9.7 ↘ 10.7 * 10.8 * 10.1 ← 9.8 ↘
 10.5 * 9.9 ← 10.3 * 10.1 ← 10.2 *
 beste Teiler 38.4 (23.) 67.0 (22.) 123.7 (26.)
 Trefferlage 1.10 mm links, 0.83 mm hoch
 Streuwert 1.15, horizontal: 1.34, vertikal: 0.93

Unterschrift des Schützen

Meyton Elektronik

Ergebnis: **299.6** (283)
 Serien: 98.0 101.7 99.9
 Zähler: 14 15 1 0 0 0 0 0 0 0
 Innenzehner: 9
 weiteste: 544 (2), 406 (1), 391 (27)
 beste Teiler 16.4 (15.) 18.9 (26.) 42.9 (29.)
 Trefferlage 0.76 mm rechts, 0.29 mm hoch
 Streuwert 1.85, horizontal: 2.09, vertikal: 1.58

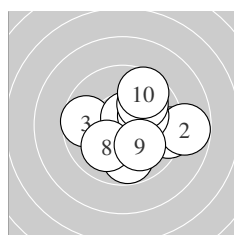
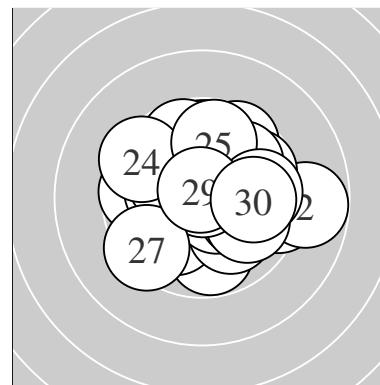

Serie 1:
 9.3 → 8.8 → 9.7 ← 9.8 ↓ 10.7 *
 10.2 * 9.9 ↗ 10.0 ↙ 10.0 ↘ 9.6 ↗
 beste Teiler 75.1 (5.) 197.7 (6.) 228.2 (8.)
 Trefferlage 1.24 mm rechts, 0.09 mm tief
 Streuwert 2.13, horizontal: 2.45, vertikal: 1.75

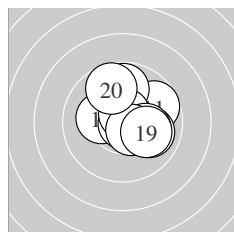

Serie 2:
 9.7 ↗ 9.8 ↑ 10.2 * 10.0 → 10.9 *
 10.7 * 10.1 → 10.5 * 10.1 → 9.7 ↖
 beste Teiler 16.4 (15.) 74.3 (16.) 102.7 (18.)
 Trefferlage 0.73 mm rechts, 0.51 mm hoch
 Streuwert 1.49, horizontal: 1.52, vertikal: 1.46

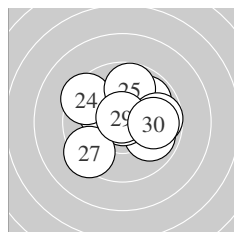

Serie 3:
 9.9 ↘ 9.9 ↗ 10.2 * 9.4 ↖ 9.8 ↑
 10.9 * 9.4 ↙ 9.7 → 10.8 * 9.9 →
 beste Teiler 18.9 (26.) 42.9 (29.) 188.8 (23.)
 Trefferlage 0.30 mm rechts, 0.46 mm hoch
 Streuwert 1.97, horizontal: 2.29, vertikal: 1.60

Unterschrift des Schützen

Meyton Elektronik

Ergebnis: **307.3** (293)
 Serien: 102.1 102.9 102.3
 Zähler: 23 7 0 0 0 0 0 0 0 0
 Innenzehner: 20
 weiteste: 369 (20), 345 (10), 334 (9)
 beste Teiler 32.1 (2.) 56.8 (7.) 59.9 (27.)
 Trefferlage 0.12 mm rechts, 0.51 mm hoch
 Streuwert 1.37, horizontal: 1.16, vertikal: 1.55

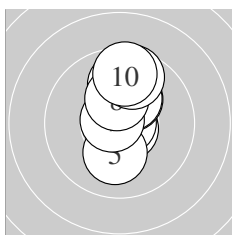
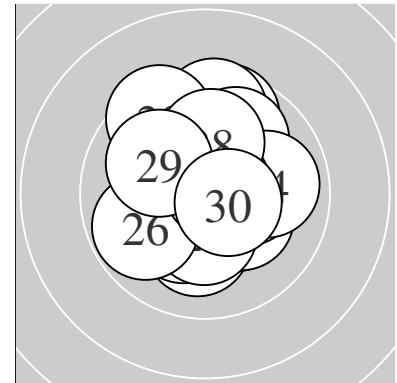

Serie 1:
 10.7 * 10.8 * 10.2 * 9.9 ↑ 10.1 ↓
 10.2 * 10.7 * 10.3 * 9.6 † 9.6 †
 beste Teiler 32.1 (2.) 56.8 (7.) 61.0 (1.)
 Trefferlage 0.25 mm rechts, 1.23 mm hoch
 Streuwert 1.28, horizontal: 0.49, vertikal: 1.75

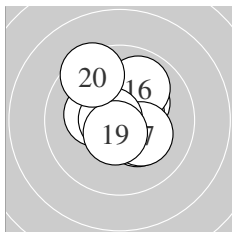

Serie 2:
 10.7 * 10.3 * 10.2 * 10.3 * 10.5 *
 9.9 † 10.2 * 10.7 * 10.6 * 9.5 †
 beste Teiler 61.6 (11.) 64.2 (18.) 93.9 (19.)
 Trefferlage 0.10 mm rechts, 0.48 mm hoch
 Streuwert 1.34, horizontal: 1.29, vertikal: 1.38

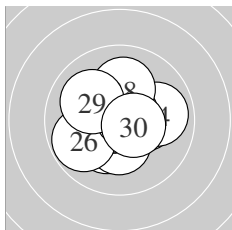

Serie 3:
 10.3 * 10.3 * 10.4 * 9.9 → 10.3 *
 9.8 † 10.7 * 10.1 † 10.0 † 10.5 *
 beste Teiler 59.9 (27.) 103.4 (30.) 136.0 (23.)
 Trefferlage 0.00 mm , 0.17 mm tief
 Streuwert 1.42, horizontal: 1.56, vertikal: 1.27

Unterschrift des Schützen

Ergebnis: **301.9** (290)
 Serien: 100.2 101.1 100.6
 Zähler: 22 6 2 0 0 0 0 0 0 0
 Innenzehner: 14
 weiteste: 592 (4), 546 (25), 356 (17)
 beste Teiler 67.4 (21.) 72.4 (24.) 87.0 (9.)
 Trefferlage 0.04 mm links, 0.07 mm hoch
 Streuwert 1.81, horizontal: 2.14, vertikal: 1.39

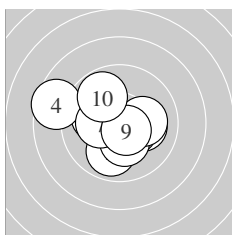
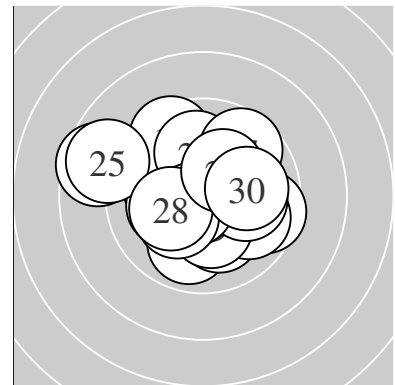

Serie 1:
 10.1 → 9.9 ↓ 10.1 ← 8.6 ↖ 10.4 *
 10.3 * 10.3 * 10.1 → 10.6 * 9.8 ↘
 beste Teiler 87.0 (9.) 128.8 (5.) 169.0 (6.)
 Trefferlage 0.55 mm links, 0.08 mm tief
 Streuwert 1.95, horizontal: 2.35, vertikal: 1.43

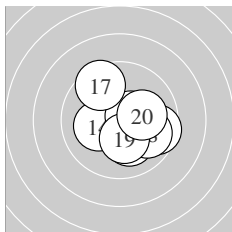

Serie 2:
 9.6 → 10.5 * 10.4 * 10.2 * 10.5 *
 10.1 ↓ 9.5 ↘ 9.9 ↘ 10.3 * 10.1 →
 beste Teiler 101.0 (15.) 109.5 (12.) 130.3 (13.)
 Trefferlage 0.62 mm rechts, 0.23 mm tief
 Streuwert 1.61, horizontal: 1.78, vertikal: 1.42

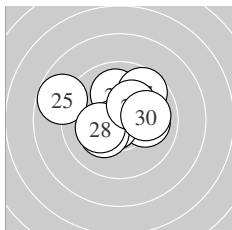

Serie 3:
 10.7 * 10.0 ↑ 10.0 → 10.7 * 8.8 ↖
 10.2 * 9.7 ↗ 10.2 * 10.3 * 10.0 →
 beste Teiler 67.4 (21.) 72.4 (24.) 172.2 (29.)
 Trefferlage 0.19 mm links, 0.55 mm hoch
 Streuwert 1.88, horizontal: 2.30, vertikal: 1.34

Unterschrift des Schützen

Ergebnis: **310.3** (296)
 Serien: 103.2 102.4 104.7
 Zähler: 26 4 0 0 0 0 0 0 0 0
 Innenzehner: 23
 weiteste: 361 (5), 309 (16), 290 (6)
 beste Teiler 28.3 (22.) 42.7 (3.) 68.5 (2.)
 Trefferlage 0.76 mm links, 0.00 mm
 Streuwert 1.09, horizontal: 1.13, vertikal: 1.06

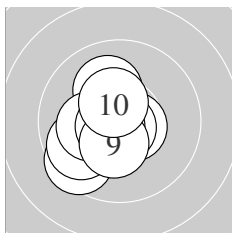
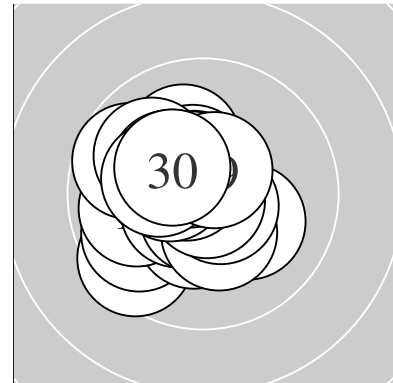

Serie 1:
 10.6 * 10.7 * 10.8 * 10.1 † 9.5 †
 9.8 † 10.2 * 10.7 * 10.4 * 10.4 *
 beste Teiler 42.7 (3.) 68.5 (2.) 69.7 (8.)
 Trefferlage 0.84 mm links, 0.42 mm tief
 Streuwert 1.21, horizontal: 1.12, vertikal: 1.29

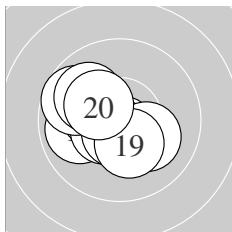

Serie 2:
 9.9 † 10.3 * 10.7 * 10.5 * 10.6 *
 9.7 † 10.0 † 10.1 † 10.3 * 10.3 *
 beste Teiler 70.0 (13.) 83.6 (15.) 112.3 (14.)
 Trefferlage 0.89 mm links, 0.10 mm tief
 Streuwert 1.27, horizontal: 1.45, vertikal: 1.06

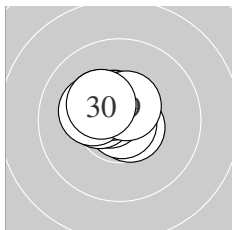

Serie 3:
 10.6 * 10.8 * 10.6 * 10.5 * 10.4 *
 10.3 * 10.5 * 10.2 * 10.5 * 10.3 *
 beste Teiler 28.3 (22.) 78.4 (23.) 82.6 (21.)
 Trefferlage 0.56 mm links, 0.56 mm hoch
 Streuwert 0.68, horizontal: 0.80, vertikal: 0.54

Unterschrift des Schützen

Ergebnis: **307.8** (297)
 Serien: 102.2 102.6 103.0
 Zähler: 27 3 0 0 0 0 0 0 0 0
 Innenzehner: 21
 weiteste: 277 (21), 257 (3), 254 (14)
 beste Teiler 72.9 (2.) 90.6 (27.) 94.4 (22.)
 Trefferlage 0.23 mm rechts, 0.12 mm hoch
 Streuwert 1.30, horizontal: 1.25, vertikal: 1.35

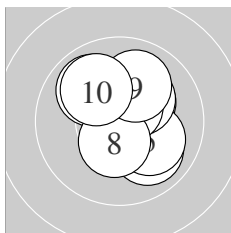
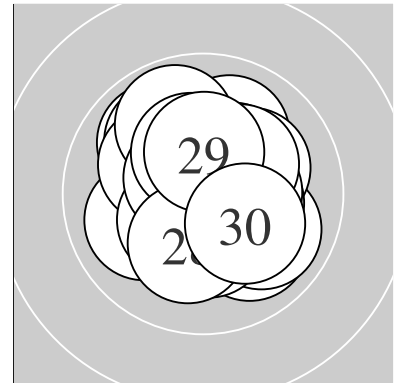

Serie 1:
 10.0 ↘ 10.7 * 9.9 ↘ 10.3 * 10.1 ↘
 10.2 * 10.6 * 10.4 * 10.0 ↗ 10.0 ↘
 beste Teiler 72.9 (2.) 100.1 (7.) 130.0 (8.)
 Trefferlage 0.39 mm rechts, 0.46 mm hoch
 Streuwert 1.40, horizontal: 1.27, vertikal: 1.52

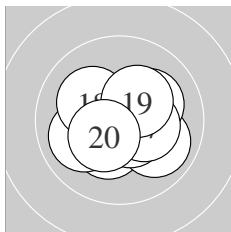

Serie 2:
 10.5 * 10.3 * 10.0 ↙ 9.9 ↘ 10.6 *
 10.1 ↗ 10.3 * 10.2 * 10.3 * 10.4 *
 beste Teiler 97.6 (15.) 114.0 (11.) 137.1 (20.)
 Trefferlage 0.06 mm rechts, 0.29 mm tief
 Streuwert 1.32, horizontal: 1.56, vertikal: 1.01

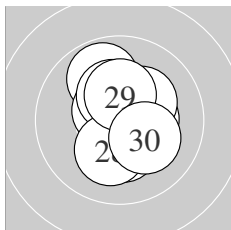

Serie 3:
 9.8 ↖ 10.6 * 10.3 * 10.4 * 10.3 *
 10.3 * 10.6 * 10.2 * 10.3 * 10.2 *
 beste Teiler 90.6 (27.) 94.4 (22.) 146.1 (24.)
 Trefferlage 0.24 mm rechts, 0.21 mm hoch
 Streuwert 1.26, horizontal: 0.97, vertikal: 1.50

Unterschrift des Schützen

Ergebnis: **314.3** (298)
 Serien: 103.8 105.6 104.9
 Zähler: 28 2 0 0 0 0 0 0 0 0
 Innenzehner: 26
 weiteste: 316 (9), 276 (24), 215 (2)
 beste Teiler 1.0 (23.) 22.1 (17.) 23.7 (27.)
 Trefferlage 0.19 mm rechts, 0.05 mm tief
 Streuwert 0.99, horizontal: 0.92, vertikal: 1.05

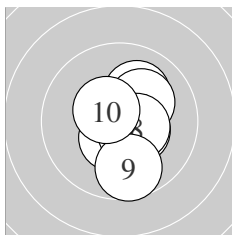
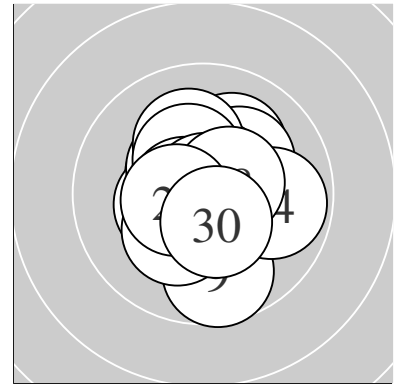

Serie 1:
 10.4 * 10.1 ↗ 10.7 * 10.7 * 10.5 *
 10.5 * 10.2 * 10.5 * 9.7 ↓ 10.5 *
 beste Teiler 62.2 (3.) 65.1 (4.) 110.3 (6.)
 Trefferlage 0.54 mm rechts, 0.29 mm tief
 Streuwert 1.12, horizontal: 0.78, vertikal: 1.38

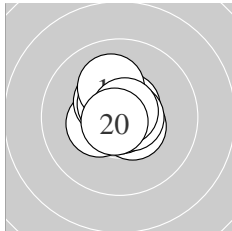

Serie 2:
 10.5 * 10.4 * 10.4 * 10.5 * 10.6 *
 10.1 ↑ 10.9 * 10.7 * 10.7 * 10.8 *
 beste Teiler 22.1 (17.) 45.3 (20.) 52.4 (19.)
 Trefferlage 0.12 mm links, 0.34 mm hoch
 Streuwert 0.78, horizontal: 0.74, vertikal: 0.82

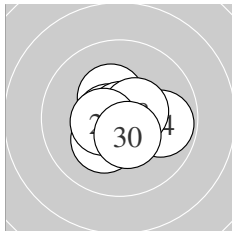

Serie 3:
 10.5 * 10.2 * 10.9 * 9.8 → 10.4 *
 10.7 * 10.9 * 10.5 * 10.5 * 10.5 *
 beste Teiler 1.0 (23.) 23.7 (27.) 73.1 (26.)
 Trefferlage 0.14 mm rechts, 0.21 mm tief
 Streuwert 1.01, horizontal: 1.15, vertikal: 0.84

Unterschrift des Schützen

Ergebnis: **311.6** (297)
 Serien: 104.0 102.8 104.8
 Zähler: 27 3 0 0 0 0 0 0 0 0
 Innenzehner: 25
 weiteste: 469 (18), 372 (2), 302 (11)
 beste Teiler 6.0 (25.) 42.7 (13.) 43.6 (16.)
 Trefferlage 0.19 mm rechts, 0.00 mm
 Streuwert 1.25, horizontal: 1.50, vertikal: 0.94

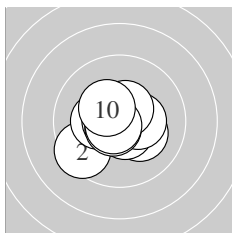
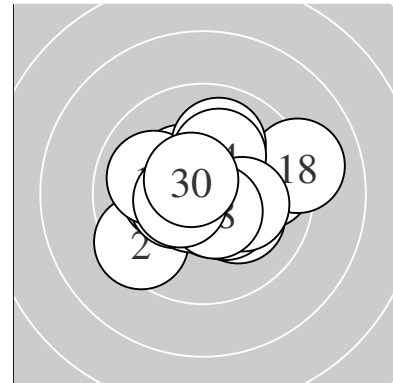

Serie 1:
 10.2 * 9.5 ↙ 10.6 * 10.3 * 10.7 *
 10.4 * 10.7 * 10.5 * 10.7 * 10.4 *
 beste Teiler 59.6 (9.) 72.8 (7.) 74.0 (5.)
 Trefferlage 0.33 mm links, 0.28 mm tief
 Streuwert 1.20, horizontal: 1.39, vertikal: 0.97

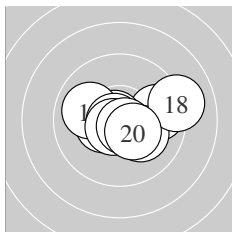

Serie 2:
 9.7 → 10.4 * 10.8 * 10.0 ↖ 10.2 *
 10.8 * 10.7 * 9.1 → 10.7 * 10.4 *
 beste Teiler 42.7 (13.) 43.6 (16.) 62.4 (19.)
 Trefferlage 0.56 mm rechts, 0.06 mm tief
 Streuwert 1.54, horizontal: 2.05, vertikal: 0.77

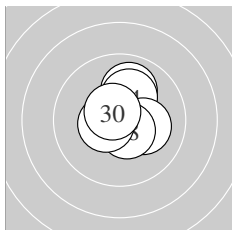

Serie 3:
 10.7 * 10.6 * 10.0 ↑ 10.2 * 10.9 *
 10.6 * 10.2 * 10.5 * 10.5 * 10.6 *
 beste Teiler 6.0 (25.) 64.4 (21.) 77.3 (22.)
 Trefferlage 0.35 mm rechts, 0.34 mm hoch
 Streuwert 0.94, horizontal: 0.81, vertikal: 1.05

Unterschrift des Schützen

Meyton Elektronik

Ergebnis: **310.4** (296)
 Serien: 103.3 103.6 103.5
 Zähler: 26 4 0 0 0 0 0 0 0 0
 Innenzehner: 21
 weiteste: 335 (2), 326 (12), 259 (14)
 beste Teiler 33.7 (21.) 45.7 (8.) 47.0 (15.)
 Trefferlage 0.38 mm links, 0.60 mm hoch
 Streuwert 1.11, horizontal: 1.03, vertikal: 1.19

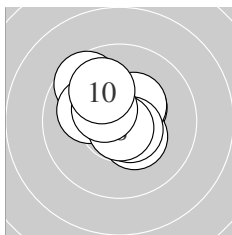
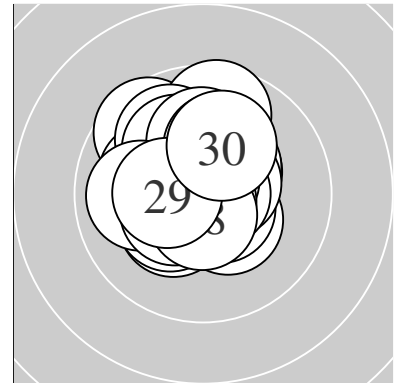

Serie 1:
 10.6 * 9.6 ↘ 10.4 * 10.1 ↖ 10.4 *
 10.4 * 10.6 * 10.8 * 10.4 * 10.0 ↘
 beste Teiler 45.7 (8.) 86.5 (1.) 91.0 (7.)
 Trefferlage 0.26 mm links, 0.68 mm hoch
 Streuwert 1.19, horizontal: 1.26, vertikal: 1.12

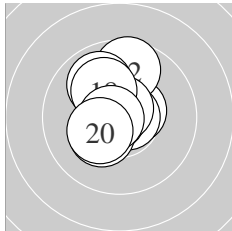

Serie 2:
 10.5 * 9.6 ↑ 10.7 * 9.9 ↘ 10.8 *
 10.3 * 10.7 * 10.1 ↘ 10.7 * 10.3 *
 beste Teiler 47.0 (15.) 51.0 (13.) 58.8 (19.)
 Trefferlage 0.39 mm links, 0.61 mm hoch
 Streuwert 1.16, horizontal: 0.86, vertikal: 1.40

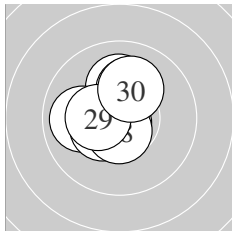

Serie 3:
 10.8 * 10.5 * 10.5 * 10.1 ↑ 10.2 *
 9.9 ← 10.4 * 10.6 * 10.4 * 10.1 ↑
 beste Teiler 33.7 (21.) 86.0 (28.) 102.0 (22.)
 Trefferlage 0.50 mm links, 0.51 mm hoch
 Streuwert 1.08, horizontal: 1.02, vertikal: 1.14

Unterschrift des Schützen

Ergebnis: **303.7** (291)
 Serien: 101.2 100.6 101.9
 Zähler: 21 9 0 0 0 0 0 0 0 0
 Innenzehner: 16
 weiteste: 418 (21), 399 (10), 318 (20)
 beste Teiler 71.7 (30.) 82.2 (4.) 118.1 (24.)
 Trefferlage 0.04 mm links, 0.49 mm hoch
 Streuwert 1.56, horizontal: 1.62, vertikal: 1.49

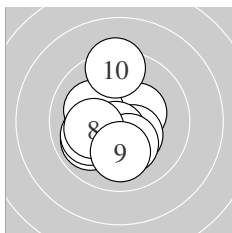
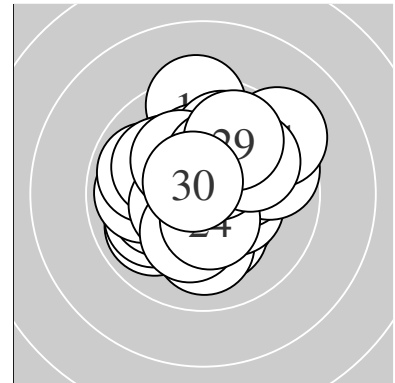

Serie 1:
 10.4 * 10.1 ↖ 10.4 * 10.6 * 9.9 ↙
 10.0 ↙ 10.2 * 10.2 * 10.0 ↓ 9.4 ↑
 beste Teiler 82.2 (4.) 142.1 (3.) 142.2 (1.)
 Trefferlage 0.58 mm links, 0.33 mm tief
 Streuwert 1.59, horizontal: 1.36, vertikal: 1.79

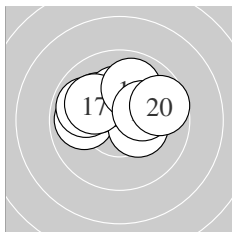

Serie 2:
 9.9 ← 10.1 ↖ 10.2 * 10.4 * 9.9 ↖
 10.2 * 10.1 ↖ 9.9 ↑ 10.2 * 9.7 →
 beste Teiler 147.4 (14.) 181.7 (16.) 183.8 (19.)
 Trefferlage 0.07 mm links, 1.04 mm hoch
 Streuwert 1.52, horizontal: 1.98, vertikal: 0.83

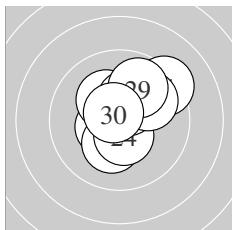

Serie 3:
 9.3 ↗ 10.5 * 10.2 * 10.5 * 10.2 *
 10.5 * 10.3 * 9.9 ↗ 9.8 ↗ 10.7 *
 beste Teiler 71.7 (30.) 118.1 (24.) 119.9 (22.)
 Trefferlage 0.51 mm rechts, 0.76 mm hoch
 Streuwert 1.44, horizontal: 1.43, vertikal: 1.45

Unterschrift des Schützen

Ergebnis: **306.6** (294)
 Serien: 102.4 102.9 101.3
 Zähler: 24 6 0 0 0 0 0 0 0 0
 Innenzehner: 19
 weiteste: 401 (25), 381 (2), 360 (30)
 beste Teiler 53.9 (14.) 64.4 (3.) 72.3 (11.)
 Trefferlage 0.06 mm links, 0.33 mm hoch
 Streuwert 1.46, horizontal: 1.35, vertikal: 1.56

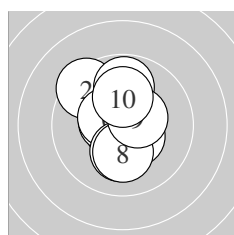
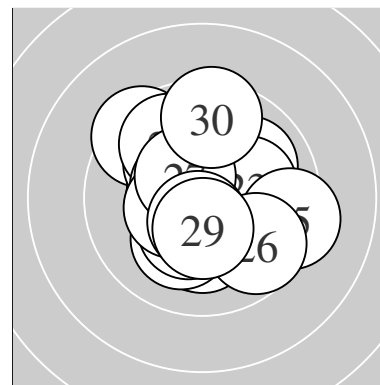

Serie 1:
 10.5 * 9.4 ↘ 10.7 * 10.5 * 9.8 ↑
 10.5 * 10.2 * 10.2 * 10.5 * 10.1 ↑
 beste Teiler 64.4 (3.) 106.2 (4.) 121.7 (1.)
 Trefferlage 0.34 mm links, 0.40 mm hoch
 Streuwert 1.45, horizontal: 1.09, vertikal: 1.74

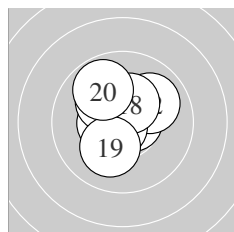

Serie 2:
 10.7 * 10.0 ↗ 10.5 * 10.7 * 10.5 *
 10.0 ↘ 10.2 * 10.4 * 10.1 ↙ 9.8 ↘
 beste Teiler 53.9 (14.) 72.3 (11.) 115.2 (15.)
 Trefferlage 0.34 mm links, 0.77 mm hoch
 Streuwert 1.21, horizontal: 1.12, vertikal: 1.29

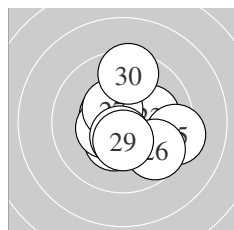

Serie 3:
 10.4 * 10.5 * 10.1 → 10.4 * 9.3 →
 9.7 ↘ 10.5 * 10.5 * 10.4 * 9.5 ↑
 beste Teiler 106.7 (28.) 108.7 (22.) 122.6 (27.)
 Trefferlage 0.50 mm rechts, 0.16 mm tief
 Streuwert 1.67, horizontal: 1.70, vertikal: 1.63

Unterschrift des Schützen

Ergebnis: **296.5** (284)
 Serien: 97.4 99.8 99.3
 Zähler: 16 12 2 0 0 0 0 0 0 0
 Innenzehner: 10
 weiteste: 609 (30), 549 (11), 464 (3)
 beste Teiler 73.9 (23.) 114.0 (29.) 114.9 (25.)
 Trefferlage 0.25 mm links, 0.02 mm tief
 Streuwert 2.14, horizontal: 2.23, vertikal: 2.04

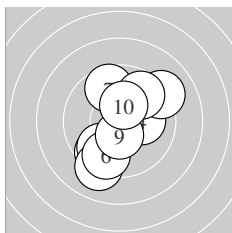
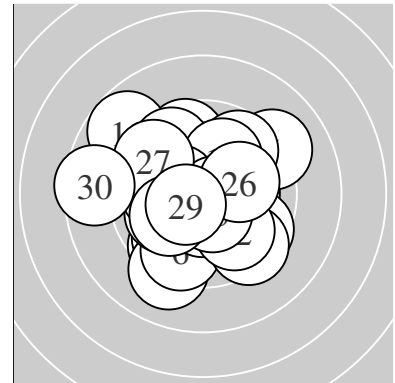

Serie 1:
 9.6 ↙ 9.8 ↙ 9.1 ↙ 10.1 → 9.1 ↗
 9.6 ↘ 9.7 ↗ 9.7 ↗ 10.4 * 10.3 *
 beste Teiler 129.0 (9.) 153.7 (10.) 205.0 (4.)
 Trefferlage 0.03 mm rechts, 0.45 mm tief
 Streuwert 2.38, horizontal: 2.01, vertikal: 2.70

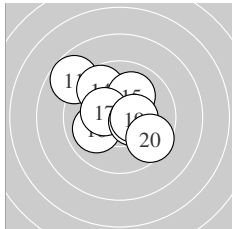

Serie 2:
 8.8 ↘ 10.2 * 10.2 * 9.7 ↘ 10.1 ↗
 10.0 ↙ 10.4 * 10.4 * 10.4 * 9.6 ↘
 beste Teiler 129.0 (18.) 136.5 (19.) 149.9 (17.)
 Trefferlage 0.16 mm links, 0.84 mm hoch
 Streuwert 1.95, horizontal: 2.14, vertikal: 1.74

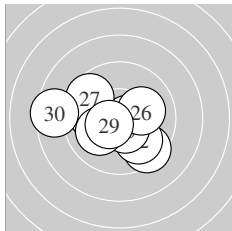

Serie 3:
 9.4 ↘ 9.9 ↘ 10.7 * 10.0 ← 10.5 *
 10.1 → 9.6 ↘ 10.1 ↙ 10.5 * 8.5 ←
 beste Teiler 73.9 (23.) 114.0 (29.) 114.9 (25.)
 Trefferlage 0.64 mm links, 0.46 mm tief
 Streuwert 2.14, horizontal: 2.69, vertikal: 1.38

Unterschrift des Schützen

Ergebnis: **287.4** (277)
 Serien: 95.7 93.7 98.0
 Zähler: 15 9 5 0 1 0 0 0 0 0
 Innenzehner: 8
 weiteste: 1236 (1), 650 (7), 647 (19)
 beste Teiler 57.7 (20.) 80.5 (10.) 94.3 (9.)
 Trefferlage 0.83 mm links, 1.60 mm hoch
 Streuwert 2.72, horizontal: 3.46, vertikal: 1.69

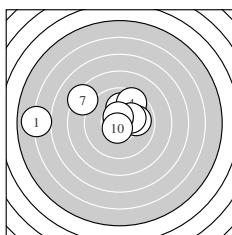
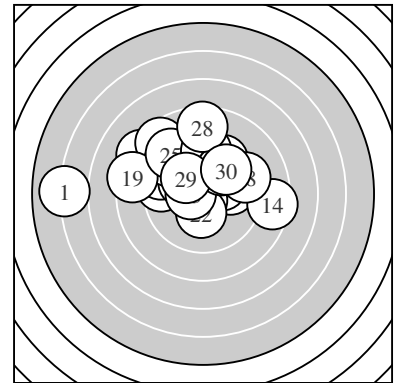

Serie 1:
 6.0 ← 10.0 ↑ 10.0 ↗ 9.6 ↗ 10.3 *
 10.0 → 8.4 ↘ 10.2 * 10.6 * 10.6 *
 beste Teiler 80.5 (10.) 94.3 (9.) 159.1 (5.)
 Trefferlage 0.90 mm links, 1.23 mm hoch
 Streuwert 3.40, horizontal: 4.62, vertikal: 1.32

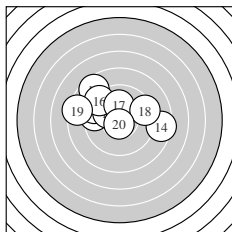

Serie 2:
 9.4 ← 9.3 ↖ 10.1 ↖ 8.5 → 8.6 ↘
 9.3 ↘ 10.1 ↑ 9.3 → 8.4 ← 10.7 *
 beste Teiler 57.7 (20.) 204.0 (13.) 225.2 (17.)
 Trefferlage 1.25 mm links, 1.46 mm hoch
 Streuwert 2.93, horizontal: 3.82, vertikal: 1.60

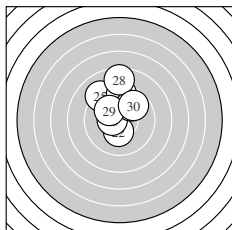

Serie 3:
 10.3 * 10.3 * 10.5 * 10.0 ↘ 9.1 ↘
 9.4 ↑ 9.9 ↗ 8.6 ↑ 10.1 ↘ 9.8 ↗
 beste Teiler 110.0 (23.) 168.8 (22.) 169.4 (21.)
 Trefferlage 0.34 mm links, 2.10 mm hoch
 Streuwert 1.82, horizontal: 1.49, vertikal: 2.10

Unterschrift des Schützen

Meyton Elektronik

Ergebnis: **314.1** (298)
 Serien: 105.0 106.5 102.6
 Zähler: 28 2 0 0 0 0 0 0 0 0
 Innenzehner: 27
 weiteste: 277 (24), 252 (4), 208 (22)
 beste Teiler 10.0 (3.) 11.1 (16.) 21.9 (1.)
 Trefferlage 0.00 mm , 0.26 mm tief
 Streuwert 0.98, horizontal: 1.03, vertikal: 0.93

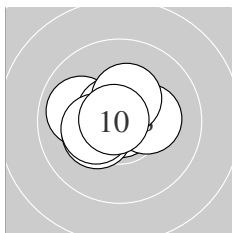
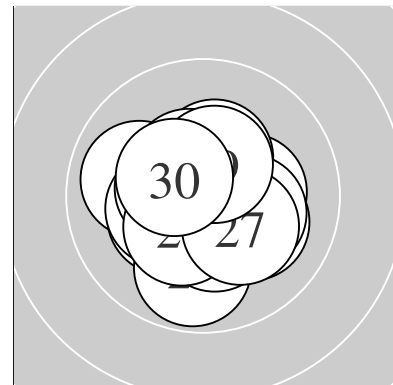

Serie 1:
 10.9 * 10.6 * 10.9 * 9.9 ↖ 10.3 *
 10.7 * 10.3 * 10.3 * 10.3 * 10.8 *
 beste Teiler 10.0 (3.) 21.9 (1.) 38.3 (10.)
 Trefferlage 0.33 mm links, 0.19 mm hoch
 Streuwert 0.97, horizontal: 1.22, vertikal: 0.62

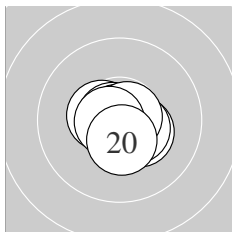

Serie 2:
 10.4 * 10.5 * 10.8 * 10.8 * 10.8 *
 10.9 * 10.5 * 10.7 * 10.7 * 10.4 *
 beste Teiler 11.1 (16.) 40.2 (14.) 47.7 (13.)
 Trefferlage 0.06 mm rechts, 0.26 mm tief
 Streuwert 0.62, horizontal: 0.73, vertikal: 0.49

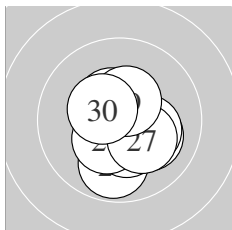

Serie 3:
 10.2 * 10.1 ↗ 10.2 * 9.8 ↓ 10.4 *
 10.4 * 10.2 * 10.5 * 10.4 * 10.4 *
 beste Teiler 121.6 (28.) 128.4 (29.) 130.9 (30.)
 Trefferlage 0.28 mm rechts, 0.70 mm tief
 Streuwert 1.20, horizontal: 1.07, vertikal: 1.32

Unterschrift des Schützen

Ergebnis: **299.0** (284)
 Serien: 99.3 98.7 101.0
 Zähler: 15 14 1 0 0 0 0 0 0 0
 Innenzehner: 12
 weiteste: 695 (18), 432 (8), 416 (9)
 beste Teiler 47.8 (23.) 51.0 (21.) 59.6 (2.)
 Trefferlage 0.82 mm rechts, 0.10 mm hoch
 Streuwert 1.94, horizontal: 2.19, vertikal: 1.65

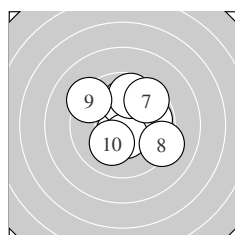
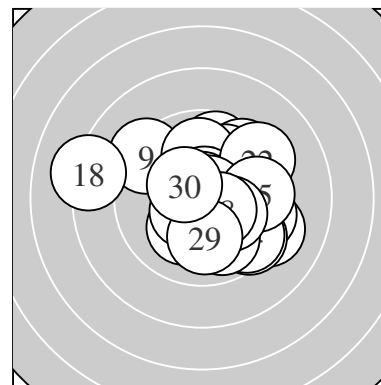

Serie 1:
 10.3 * 10.7 * 9.8 → 10.1 ↑ 10.5 *
 9.7 ↑ 9.6 ↗ 9.2 ↘ 9.3 ↖ 10.1 ↙
 beste Teiler 59.6 (2.) 111.8 (5.) 155.0 (1.)
 Trefferlage 0.69 mm rechts, 0.57 mm hoch
 Streuwert 1.97, horizontal: 2.07, vertikal: 1.85

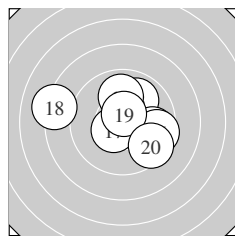

Serie 2:
 10.2 * 10.7 * 9.9 ↗ 9.7 → 9.5 →
 9.9 ↑ 10.5 * 8.2 ← 10.6 * 9.5 ↘
 beste Teiler 65.5 (12.) 83.0 (19.) 118.3 (17.)
 Trefferlage 0.52 mm rechts, 0.17 mm hoch
 Streuwert 2.35, horizontal: 2.94, vertikal: 1.54

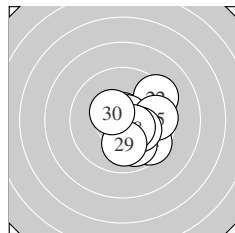

Serie 3:
 10.7 * 9.3 ↗ 10.8 * 9.6 ↘ 9.6 →
 9.9 ↓ 10.2 * 10.5 * 10.0 ↓ 10.4 *
 beste Teiler 47.8 (23.) 51.0 (21.) 123.4 (28.)
 Trefferlage 1.25 mm rechts, 0.44 mm tief
 Streuwert 1.51, horizontal: 1.47, vertikal: 1.54

Unterschrift des Schützen

Meyton Elektronik

Ergebnis: **306.9** (292)
 Serien: 101.7 103.0 102.2
 Zähler: 22 8 0 0 0 0 0 0 0 0
 Innenzehner: 19
 weiteste: 341 (29), 318 (8), 315 (18)
 beste Teiler 51.4 (30.) 66.6 (17.) 67.2 (9.)
 Trefferlage 0.41 mm links, 0.85 mm tief
 Streuwert 1.26, horizontal: 1.14, vertikal: 1.37

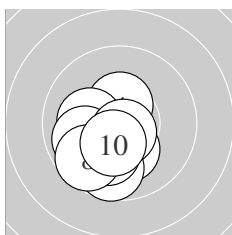
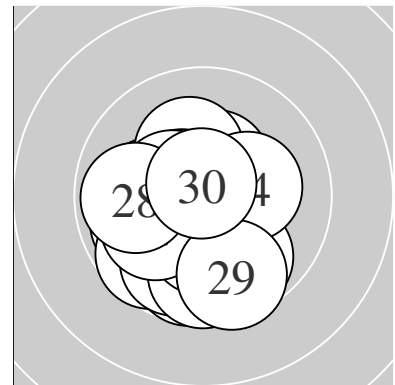

Serie 1:
 10.4 * 10.2 * 9.7 ↓ 10.5 * 10.1 ↙
 10.1 ← 9.9 ← 9.7 ↗ 10.7 * 10.4 *
 beste Teiler 67.2 (9.) 123.0 (4.) 141.9 (10.)
 Trefferlage 0.81 mm links, 1.22 mm tief
 Streuwert 1.14, horizontal: 1.02, vertikal: 1.24

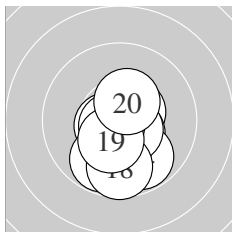

Serie 2:
 10.5 * 10.6 * 10.5 * 9.8 ↘ 10.6 *
 9.8 ↙ 10.7 * 9.7 ↓ 10.4 * 10.4 *
 beste Teiler 66.6 (17.) 93.1 (12.) 96.2 (15.)
 Trefferlage 0.12 mm rechts, 1.00 mm tief
 Streuwert 1.17, horizontal: 0.87, vertikal: 1.41

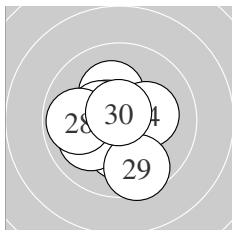

Serie 3:
 10.2 * 10.2 * 10.6 * 10.2 * 10.4 *
 10.4 * 10.0 ← 9.9 ← 9.6 ↓ 10.7 *
 beste Teiler 51.4 (30.) 98.0 (23.) 133.1 (25.)
 Trefferlage 0.57 mm links, 0.34 mm tief
 Streuwert 1.40, horizontal: 1.37, vertikal: 1.43

Unterschrift des Schützen

Ergebnis: **303.2** (289)
 Serien: 101.4 100.6 101.2
 Zähler: 19 11 0 0 0 0 0 0 0 0
 Innenzehner: 12
 weiteste: 375 (16), 363 (11), 351 (15)
 beste Teiler 54.0 (1.) 61.0 (9.) 68.2 (12.)
 Trefferlage 0.30 mm links, 0.68 mm tief
 Streuwert 1.56, horizontal: 1.83, vertikal: 1.22

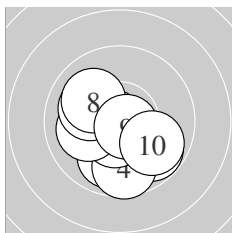
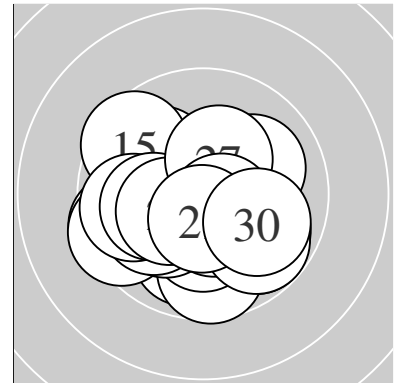

Serie 1:
 10.7 * 9.8 ↘ 9.9 ↓ 9.7 ↓ 10.5 *
 10.1 ← 10.1 ↖ 10.0 ↖ 10.7 * 9.9 ↘
 beste Teiler 54.0 (1.) 61.0 (9.) 104.9 (5.)
 Trefferlage 0.23 mm links, 0.87 mm tief
 Streuwert 1.52, horizontal: 1.59, vertikal: 1.44

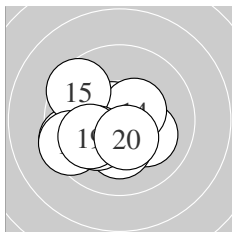

Serie 2:
 9.5 ← 10.7 * 10.1 ↘ 10.5 * 9.5 ↘
 9.5 ← 10.2 * 10.2 * 10.0 ← 10.4 *
 beste Teiler 68.2 (12.) 122.0 (14.) 129.8 (20.)
 Trefferlage 1.04 mm links, 0.62 mm tief
 Streuwert 1.59, horizontal: 1.87, vertikal: 1.24

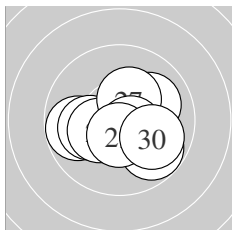

Serie 3:
 9.9 ↘ 9.8 ← 9.8 ↘ 10.0 ↗ 10.1 ←
 10.3 * 10.3 * 10.6 * 10.5 * 9.9 ↘
 beste Teiler 96.0 (28.) 104.1 (29.) 157.4 (26.)
 Trefferlage 0.36 mm rechts, 0.54 mm tief
 Streuwert 1.55, horizontal: 1.92, vertikal: 1.06

Unterschrift des Schützen

Ergebnis: **311.9** (299)
 Serien: 103.1 104.3 104.5
 Zähler: 29 1 0 0 0 0 0 0 0 0
 Innenzehner: 25
 weiteste: 254 (22), 242 (2), 231 (12)
 beste Teiler 7.0 (8.) 8.2 (29.) 23.0 (16.)
 Trefferlage 0.61 mm links, 0.51 mm tief
 Streuwert 0.95, horizontal: 1.04, vertikal: 0.86

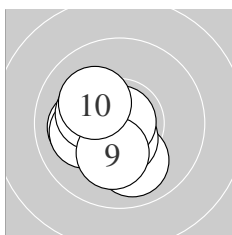
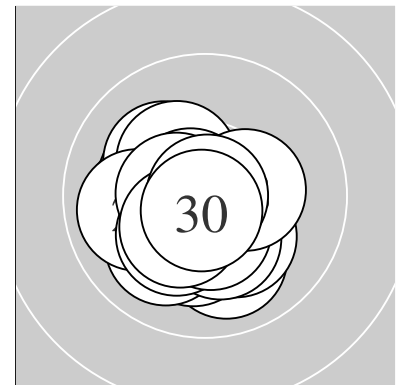

Serie 1:
 10.4 * 10.0 ↘ 10.1 ← 10.6 * 10.4 *
 10.1 ← 10.2 * 10.9 * 10.2 * 10.2 *
 beste Teiler 7.0 (8.) 96.7 (4.) 135.0 (1.)
 Trefferlage 0.96 mm links, 0.48 mm tief
 Streuwert 1.03, horizontal: 1.02, vertikal: 1.05

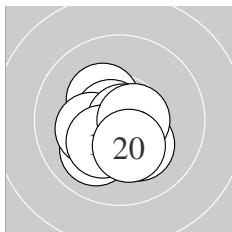

Serie 2:
 10.3 * 10.0 ↙ 10.7 * 10.8 * 10.2 *
 10.9 * 10.3 * 10.2 * 10.6 * 10.3 *
 beste Teiler 23.0 (16.) 37.5 (14.) 59.5 (13.)
 Trefferlage 0.28 mm links, 0.55 mm tief
 Streuwert 1.00, horizontal: 1.01, vertikal: 0.98

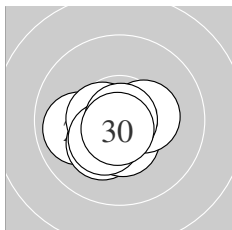

Serie 3:
 10.4 * 9.9 ← 10.6 * 10.2 * 10.5 *
 10.5 * 10.4 * 10.4 * 10.9 * 10.7 *
 beste Teiler 8.2 (29.) 55.5 (30.) 78.6 (23.)
 Trefferlage 0.59 mm links, 0.50 mm tief
 Streuwert 0.86, horizontal: 1.07, vertikal: 0.59

Unterschrift des Schützen

Ergebnis: **312.2** (299)
 Serien: 104.6 103.4 104.2
 Zähler: 29 1 0 0 0 0 0 0 0 0
 Innenzehner: 23
 weiteste: 286 (15), 228 (1), 216 (18)
 beste Teiler 19.1 (5.) 35.2 (10.) 48.4 (28.)
 Trefferlage 0.00 mm , 0.02 mm tief
 Streuwert 1.08, horizontal: 0.95, vertikal: 1.19

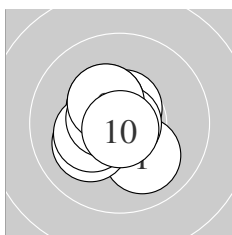
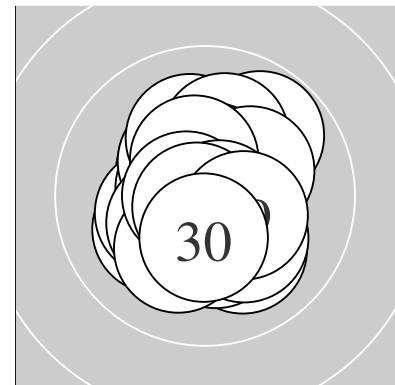

Serie 1:
 10.0 ↘ 10.5 * 10.6 * 10.4 * 10.9 *
 10.1 ↙ 10.3 * 10.6 * 10.4 * 10.8 *
 beste Teiler 19.1 (5.) 35.2 (10.) 89.9 (3.)
 Trefferlage 0.49 mm links, 0.03 mm hoch
 Streuwert 0.99, horizontal: 0.93, vertikal: 1.04

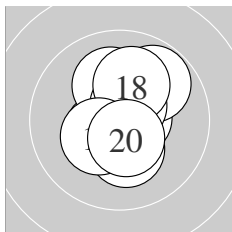

Serie 2:
 10.6 * 10.6 * 10.5 * 10.3 * 9.8 ↗
 10.1 ↑ 10.6 * 10.1 ↑ 10.3 * 10.5 *
 beste Teiler 82.0 (12.) 86.4 (11.) 99.1 (17.)
 Trefferlage 0.20 mm rechts, 0.20 mm hoch
 Streuwert 1.22, horizontal: 0.92, vertikal: 1.45

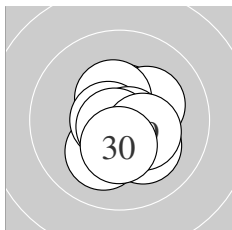

Serie 3:
 10.5 * 10.1 ↘ 10.2 * 10.1 ↙ 10.4 *
 10.7 * 10.7 * 10.8 * 10.3 * 10.4 *
 beste Teiler 48.4 (28.) 58.3 (27.) 66.0 (26.)
 Trefferlage 0.27 mm rechts, 0.29 mm tief
 Streuwert 1.01, horizontal: 0.90, vertikal: 1.10

Unterschrift des Schützen

Meyton Elektronik

Ergebnis: **307.9** (294)
 Serien: 104.3 103.4 100.2
 Zähler: 24 6 0 0 0 0 0 0 0 0
 Innenzehner: 17
 weiteste: 352 (22), 316 (24), 271 (14)
 beste Teiler 36.6 (8.) 71.4 (5.) 80.0 (17.)
 Trefferlage 0.95 mm links, 0.75 mm tief
 Streuwert 1.05, horizontal: 0.99, vertikal: 1.11

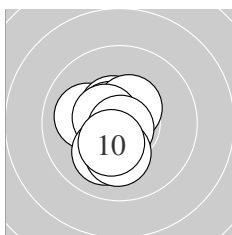
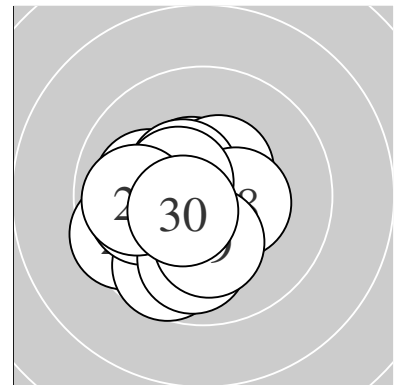

Serie 1:
 10.1 ← 10.5 * 10.6 * 10.5 * 10.7 *
 10.5 * 10.1 ↙ 10.8 * 10.1 ↓ 10.4 *
 beste Teiler 36.6 (8.) 71.4 (5.) 85.7 (3.)
 Trefferlage 0.57 mm links, 0.27 mm tief
 Streuwert 0.97, horizontal: 0.74, vertikal: 1.15

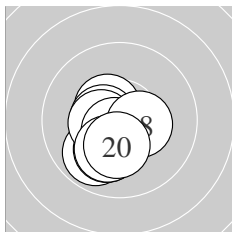

Serie 2:
 10.5 * 10.5 * 10.5 * 9.9 ↘ 10.1 ↘
 10.5 * 10.6 * 10.4 * 10.1 ↘ 10.3 *
 beste Teiler 80.0 (17.) 102.7 (11.) 111.8 (13.)
 Trefferlage 0.65 mm links, 0.84 mm tief
 Streuwert 0.93, horizontal: 0.81, vertikal: 1.04

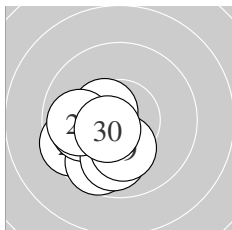

Serie 3:
 9.9 ← 9.5 ← 10.1 ← 9.7 ↘ 10.5 *
 10.0 ← 9.9 ↓ 9.9 ← 10.2 * 10.5 *
 beste Teiler 102.2 (30.) 115.4 (25.) 189.5 (29.)
 Trefferlage 1.61 mm links, 1.15 mm tief
 Streuwert 1.08, horizontal: 1.10, vertikal: 1.06

Unterschrift des Schützen

Ergebnis: **308.2** (294)
 Serien: 103.8 102.9 101.5
 Zähler: 25 4 1 0 0 0 0 0 0 0
 Innenzehner: 23
 weiteste: 634 (30), 429 (16), 331 (18)
 beste Teiler 51.0 (9.) 55.2 (2.) 61.8 (8.)
 Trefferlage 0.83 mm links, 0.00 mm
 Streuwert 1.35, horizontal: 1.73, vertikal: 0.81

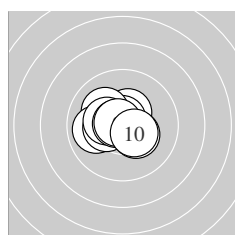
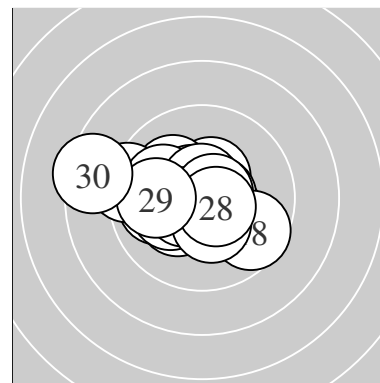

Serie 1:
 10.4 * 10.7 * 10.1 ↘ 9.9 ← 10.3 *
 10.3 * 10.3 * 10.7 * 10.7 * 10.4 *
 beste Teiler 51.0 (9.) 55.2 (2.) 61.8 (8.)
 Trefferlage 0.53 mm links, 0.15 mm hoch
 Streuwert 1.03, horizontal: 1.25, vertikal: 0.74

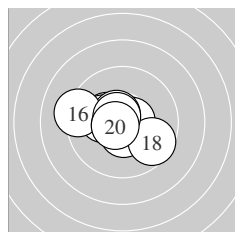

Serie 2:
 10.3 * 10.5 * 10.6 * 10.2 * 10.6 *
 9.2 ← 10.7 * 9.6 ↘ 10.6 * 10.6 *
 beste Teiler 72.7 (17.) 76.9 (20.) 77.0 (19.)
 Trefferlage 0.63 mm links, 0.03 mm tief
 Streuwert 1.41, horizontal: 1.80, vertikal: 0.86

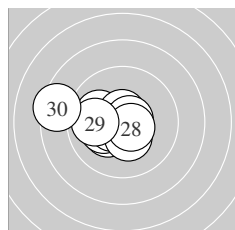

Serie 3:
 10.3 * 10.0 ↖ 10.6 * 10.2 * 10.5 *
 10.7 * 10.3 * 10.6 * 9.9 ← 8.4 ←
 beste Teiler 68.3 (26.) 82.1 (23.) 92.9 (28.)
 Trefferlage 1.32 mm links, 0.09 mm tief
 Streuwert 1.62, horizontal: 2.10, vertikal: 0.90

Unterschrift des Schützen

Meyton Elektronik

Ergebnis: **308.2** (297)
 Serien: 103.0 102.0 103.2
 Zähler: 27 3 0 0 0 0 0 0 0 0
 Innenzehner: 22
 weiteste: 289 (28), 280 (11), 275 (19)
 beste Teiler 70.0 (15.) 77.6 (9.) 82.2 (22.)
 Trefferlage 0.86 mm links, 0.05 mm hoch
 Streuwert 1.15, horizontal: 1.26, vertikal: 1.02

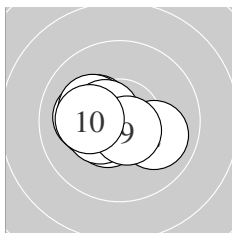
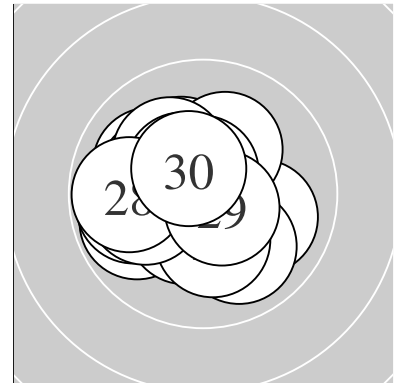

Serie 1:
 10.5 * 10.0 → 10.3 * 10.2 * 10.4 *
 10.1 ← 10.2 * 10.5 * 10.6 * 10.2 *
 beste Teiler 77.6 (9.) 104.6 (8.) 108.8 (1.)
 Trefferlage 0.93 mm links, 0.04 mm tief
 Streuwert 1.05, horizontal: 1.35, vertikal: 0.63

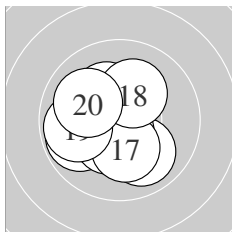

Serie 2:
 9.8 ← 10.6 * 10.2 * 10.0 ↘ 10.7 *
 10.4 * 10.2 * 10.2 * 9.9 ← 10.0 ↖
 beste Teiler 70.0 (15.) 88.2 (12.) 146.8 (16.)
 Trefferlage 0.60 mm links, 0.38 mm tief
 Streuwert 1.41, horizontal: 1.45, vertikal: 1.37

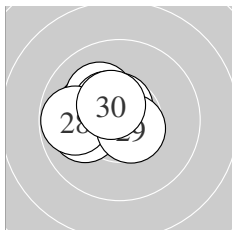

Serie 3:
 10.2 * 10.6 * 10.4 * 10.4 * 10.2 *
 10.5 * 10.0 ← 9.8 ← 10.6 * 10.5 *
 beste Teiler 82.2 (22.) 92.2 (29.) 113.7 (30.)
 Trefferlage 1.05 mm links, 0.59 mm hoch
 Streuwert 0.90, horizontal: 1.06, vertikal: 0.71

Unterschrift des Schützen

Ergebnis: **311.8** (298)
 Serien: 104.4 104.2 103.2
 Zähler: 28 2 0 0 0 0 0 0 0 0
 Innenzehner: 24
 weiteste: 416 (25), 257 (15), 235 (18)
 beste Teiler 33.3 (7.) 55.0 (10.) 69.5 (20.)
 Trefferlage 0.31 mm rechts, 0.03 mm hoch
 Streuwert 1.10, horizontal: 1.13, vertikal: 1.08

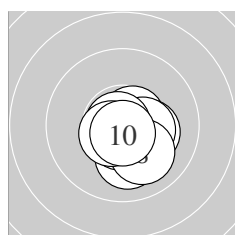
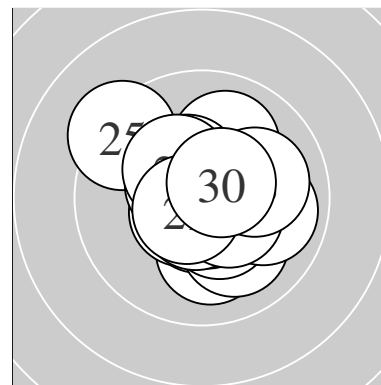

Serie 1:
 10.6 * 10.3 * 10.2 * 10.1 ↓ 10.6 *
 10.4 * 10.8 * 10.1 ↘ 10.6 * 10.7 *
 beste Teiler 33.3 (7.) 55.0 (10.) 80.9 (1.)
 Trefferlage 0.52 mm rechts, 0.74 mm tief
 Streuwert 0.81, horizontal: 0.83, vertikal: 0.80

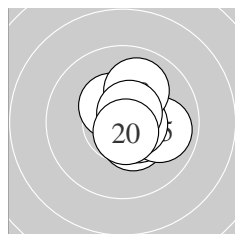

Serie 2:
 10.4 * 10.5 * 10.4 * 10.4 * 9.9 →
 10.7 * 10.6 * 10.0 ↑ 10.6 * 10.7 *
 beste Teiler 69.5 (20.) 72.8 (16.) 77.8 (19.)
 Trefferlage 0.69 mm rechts, 0.26 mm hoch
 Streuwert 0.93, horizontal: 0.82, vertikal: 1.03

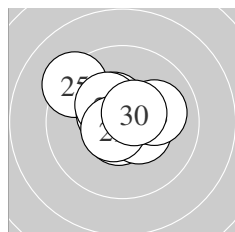

Serie 3:
 10.6 * 10.6 * 10.4 * 10.4 * 9.3 ↖
 10.5 * 10.3 * 10.0 → 10.6 * 10.5 *
 beste Teiler 76.5 (21.) 77.8 (29.) 78.0 (22.)
 Trefferlage 0.27 mm links, 0.57 mm hoch
 Streuwert 1.25, horizontal: 1.47, vertikal: 1.00

Unterschrift des Schützen

Meyton Elektronik

Ergebnis: **308.7** (294)
 Serien: 101.3 102.7 104.7
 Zähler: 24 6 0 0 0 0 0 0 0 0
 Innenzehner: 22
 weiteste: 434 (9), 322 (8), 310 (11)
 beste Teiler 29.2 (14.) 54.6 (21.) 61.2 (28.)
 Trefferlage 0.46 mm rechts, 0.33 mm hoch
 Streuwert 1.30, horizontal: 1.50, vertikal: 1.07

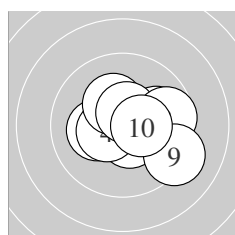
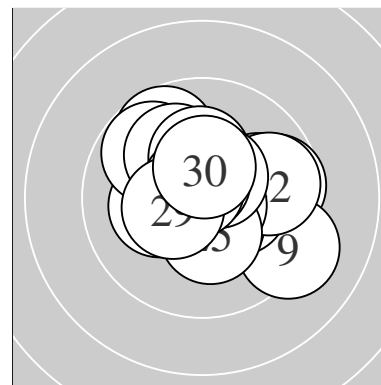

Serie 1:
 10.5 * 10.2 * 9.9 → 10.5 * 10.3 *
 10.0 → 10.6 * 9.7 → 9.2 ↘ 10.4 *
 beste Teiler 96.4 (7.) 103.0 (1.) 121.4 (4.)
 Trefferlage 1.03 mm rechts, 0.05 mm tief
 Streuwert 1.54, horizontal: 1.92, vertikal: 1.03

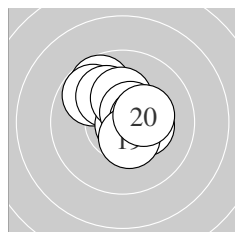

Serie 2:
 9.7 ↖ 9.8 ↖ 10.1 ↖ 10.8 * 10.2 *
 10.6 * 10.4 * 10.3 * 10.5 * 10.3 *
 beste Teiler 29.2 (14.) 91.8 (16.) 123.1 (19.)
 Trefferlage 0.05 mm rechts, 0.80 mm hoch
 Streuwert 1.27, horizontal: 1.32, vertikal: 1.21

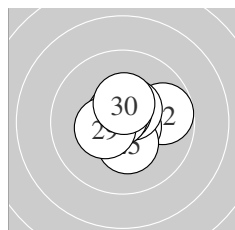

Serie 3:
 10.7 * 9.8 → 10.6 * 10.7 * 10.3 *
 10.5 * 10.6 * 10.7 * 10.4 * 10.4 *
 beste Teiler 54.6 (21.) 61.2 (28.) 66.2 (24.)
 Trefferlage 0.28 mm rechts, 0.24 mm hoch
 Streuwert 0.99, horizontal: 1.10, vertikal: 0.85

Unterschrift des Schützen

Meyton Elektronik

Ergebnis: **296.1** (282)
 Serien: 99.2 98.7 98.2
 Zähler: 13 16 1 0 0 0 0 0 0 0
 Innenzehner: 7
 weiteste: 512 (27), 401 (23), 377 (14)
 beste Teiler 43.6 (25.) 85.7 (18.) 108.3 (26.)
 Trefferlage 0.84 mm rechts, 0.04 mm tief
 Streuwert 1.98, horizontal: 2.19, vertikal: 1.74

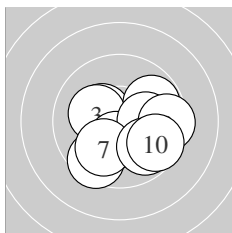
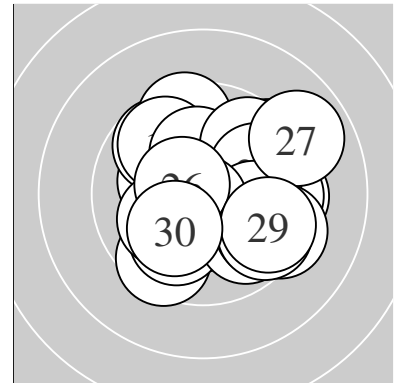

Serie 1:
 10.3 * 9.8 ↗ 10.2 * 9.5 ↘ 10.4 *
 10.1 → 10.0 ↙ 9.5 → 9.8 ↘ 9.6 ↘
 beste Teiler 150.4 (5.) 154.7 (1.) 189.1 (3.)
 Trefferlage 0.65 mm rechts, 0.76 mm tief
 Streuwert 1.85, horizontal: 2.16, vertikal: 1.47

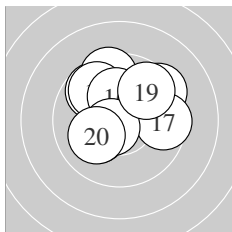

Serie 2:
 10.1 ↙ 9.7 ↖ 9.5 ↑ 9.4 ↗ 9.8 ↖
 10.2 * 9.6 → 10.6 * 9.7 ↗ 10.1 ↙
 beste Teiler 85.7 (18.) 189.2 (16.) 205.5 (11.)
 Trefferlage 0.05 mm links, 1.15 mm hoch
 Streuwert 1.92, horizontal: 2.11, vertikal: 1.71

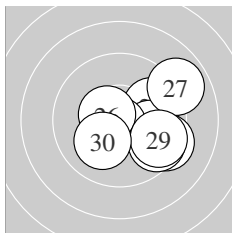

Serie 3:
 9.5 ↘ 9.9 ↗ 9.3 ↘ 10.0 → 10.8 *
 10.5 * 8.9 ↗ 9.6 ↘ 9.6 ↘ 10.1 ↙
 beste Teiler 43.6 (25.) 108.3 (26.) 211.0 (30.)
 Trefferlage 1.95 mm rechts, 0.53 mm tief
 Streuwert 1.78, horizontal: 2.02, vertikal: 1.50

Unterschrift des Schützen

Meyton Elektronik

Ergebnis: **304.3** (291)
 Serien: 102.7 100.3 101.3
 Zähler: 22 7 1 0 0 0 0 0 0 0
 Innenzehner: 19
 weiteste: 722 (18), 448 (30), 441 (27)
 beste Teiler 11.1 (28.) 43.4 (3.) 61.2 (16.)
 Trefferlage 0.50 mm links, 0.11 mm hoch
 Streuwert 1.74, horizontal: 2.18, vertikal: 1.12

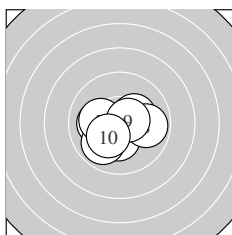
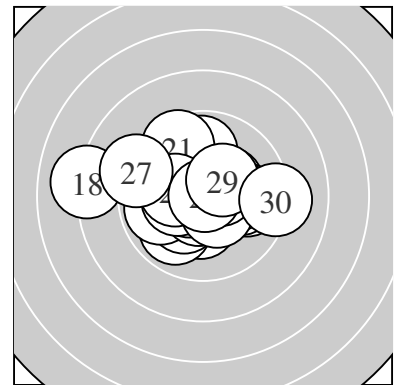

Serie 1:
 10.1 ← 10.3 * 10.8 * 10.3 * 10.3 *
 9.9 ↙ 10.2 * 9.9 → 10.6 * 10.3 *
 beste Teiler 43.4 (3.) 93.3 (9.) 152.5 (2.)
 Trefferlage 0.28 mm links, 0.50 mm tief
 Streuwert 1.33, horizontal: 1.63, vertikal: 0.93

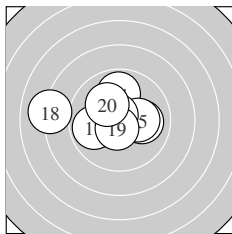

Serie 2:
 10.4 * 10.4 * 10.0 → 9.9 ↑ 10.2 *
 10.7 * 9.9 ← 8.1 ← 10.6 * 10.1 ↘
 beste Teiler 61.2 (16.) 88.2 (19.) 129.0 (11.)
 Trefferlage 1.02 mm links, 0.37 mm hoch
 Streuwert 2.02, horizontal: 2.62, vertikal: 1.11

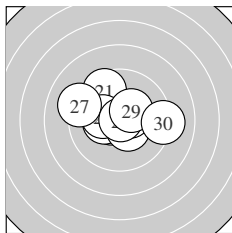

Serie 3:
 9.6 ↘ 10.6 * 10.3 * 10.4 * 10.5 *
 10.3 * 9.2 ← 10.9 * 10.3 * 9.2 →
 beste Teiler 11.1 (28.) 89.8 (22.) 110.7 (25.)
 Trefferlage 0.21 mm links, 0.46 mm hoch
 Streuwert 1.83, horizontal: 2.32, vertikal: 1.15

Unterschrift des Schützen

Ergebnis: **305.4** (291)
 Serien: 101.6 101.5 102.3
 Zähler: 21 9 0 0 0 0 0 0 0 0
 Innenzehner: 15
 weiteste: 392 (4), 331 (3), 311 (28)
 beste Teiler 29.0 (23.) 47.1 (22.) 49.2 (8.)
 Trefferlage 0.65 mm links, 0.30 mm tief
 Streuwert 1.46, horizontal: 1.68, vertikal: 1.21

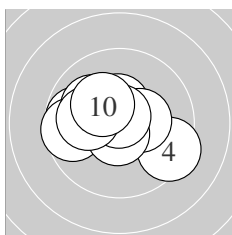
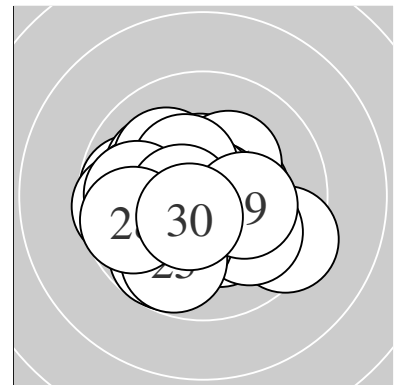

Serie 1:
 10.5 * 9.8 ← 9.6 ← 9.4 ↘ 10.4 *
 10.7 * 10.1 ↖ 10.8 * 10.1 ← 10.2 *
 beste Teiler 49.2 (8.) 75.3 (6.) 122.5 (1.)
 Trefferlage 0.69 mm links, 0.20 mm hoch
 Streuwert 1.62, horizontal: 2.07, vertikal: 0.98

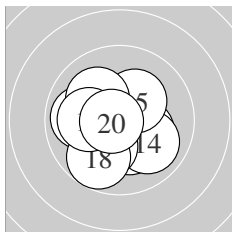

Serie 2:
 10.3 * 10.2 * 9.9 ← 10.0 ↘ 10.3 *
 10.1 ↙ 10.1 ↖ 9.8 ↙ 10.1 ← 10.7 *
 beste Teiler 57.5 (20.) 171.4 (15.) 174.1 (11.)
 Trefferlage 0.40 mm links, 0.53 mm tief
 Streuwert 1.50, horizontal: 1.62, vertikal: 1.36

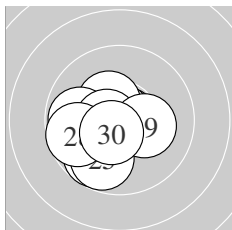

Serie 3:
 9.7 ↙ 10.8 * 10.8 * 10.4 * 9.8 ↙
 9.8 ← 10.6 * 9.7 ← 10.2 * 10.5 *
 beste Teiler 29.0 (23.) 47.1 (22.) 90.3 (27.)
 Trefferlage 0.86 mm links, 0.59 mm tief
 Streuwert 1.32, horizontal: 1.43, vertikal: 1.21

Unterschrift des Schützen

Ergebnis: **298.0** (284)
 Serien: 98.8 100.9 98.3
 Zähler: 18 9 2 1 0 0 0 0 0 0
 Innenzehner: 13
 weiteste: 862 (22), 568 (29), 501 (3)
 beste Teiler 71.5 (18.) 71.8 (21.) 84.1 (15.)
 Trefferlage 1.31 mm links, 0.56 mm tief
 Streuwert 1.94, horizontal: 2.29, vertikal: 1.52

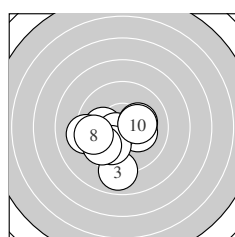
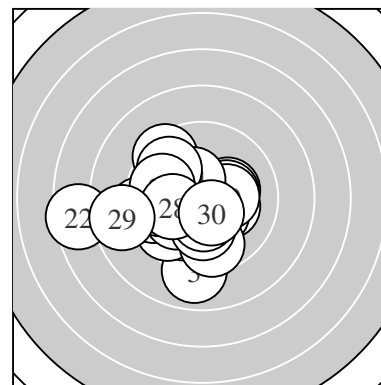

Serie 1:
 10.1 ← 9.2 ← 8.9 ↓ 10.2 * 10.6 *
 10.0 ↙ 9.7 ↙ 9.6 ← 10.2 * 10.3 *
 beste Teiler 97.0 (5.) 172.5 (10.) 184.0 (9.)
 Trefferlage 0.95 mm links, 1.10 mm tief
 Streuwert 1.91, horizontal: 2.16, vertikal: 1.63

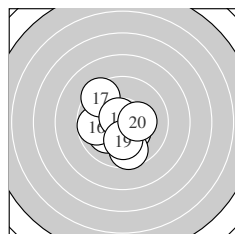

Serie 2:
 10.4 * 9.9 ← 9.6 ↓ 10.1 ↙ 10.6 *
 9.8 ← 9.4 ↘ 10.7 * 10.1 ↓ 10.3 *
 beste Teiler 71.5 (18.) 84.1 (15.) 147.8 (11.)
 Trefferlage 0.73 mm links, 0.56 mm tief
 Streuwert 1.64, horizontal: 1.67, vertikal: 1.61

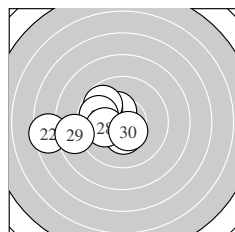

Serie 3:
 10.7 * 7.5 ← 10.4 * 10.4 * 9.8 ↘
 9.8 ↖ 10.4 * 10.1 ← 8.7 ← 10.5 *
 beste Teiler 71.8 (21.) 121.2 (30.) 135.8 (23.)
 Trefferlage 2.24 mm links, 0.02 mm tief
 Streuwert 2.18, horizontal: 2.82, vertikal: 1.26

Unterschrift des Schützen

Meyton Elektronik

Ergebnis: **305.8** (293)
 Serien: 99.3 104.4 102.1
 Zähler: 23 7 0 0 0 0 0 0 0 0
 Innenzehner: 18
 weiteste: 379 (1), 377 (3), 348 (5)
 beste Teiler 33.8 (19.) 69.8 (26.) 79.0 (17.)
 Trefferlage 0.00 mm , 0.10 mm tief
 Streuwert 1.52, horizontal: 1.68, vertikal: 1.33

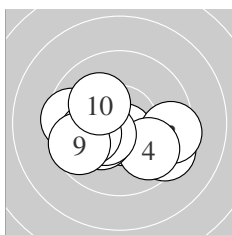
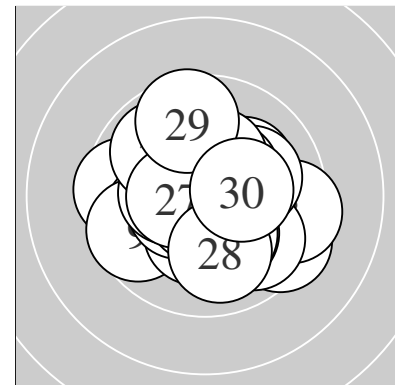

Serie 1:
 9.4 ↘ 10.6 * 9.4 → 9.8 ↘ 9.6 ←
 10.3 * 10.4 * 10.1 ← 9.6 ← 10.1 ↖
 beste Teiler 86.0 (2.) 131.8 (7.) 173.8 (6.)
 Trefferlage 0.29 mm links, 0.77 mm tief
 Streuwert 1.93, horizontal: 2.54, vertikal: 1.00

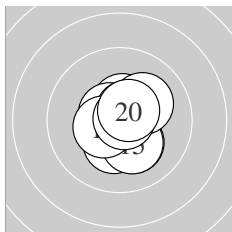

Serie 2:
 10.2 * 10.5 * 10.6 * 10.3 * 10.2 *
 10.1 ↗ 10.6 * 10.5 * 10.8 * 10.6 *
 beste Teiler 33.8 (19.) 79.0 (17.) 87.1 (13.)
 Trefferlage 0.29 mm rechts, 0.11 mm tief
 Streuwert 1.01, horizontal: 0.85, vertikal: 1.14

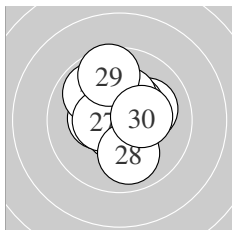

Serie 3:
 10.1 → 10.4 * 10.3 * 10.3 * 9.9 ↖
 10.7 * 10.5 * 10.0 ↓ 9.6 ↑ 10.3 *
 beste Teiler 69.8 (26.) 118.0 (27.) 139.3 (22.)
 Trefferlage 0.00 mm , 0.58 mm hoch
 Streuwert 1.44, horizontal: 1.33, vertikal: 1.53

Unterschrift des Schützen

Ergebnis: **314.2** (298)
 Serien: 104.2 106.0 104.0
 Zähler: 28 2 0 0 0 0 0 0 0 0
 Innenzehner: 28
 weiteste: 270 (23), 269 (10), 190 (1)
 beste Teiler 27.0 (17.) 31.0 (7.) 34.5 (11.)
 Trefferlage 0.07 mm rechts, 0.25 mm tief
 Streuwert 0.95, horizontal: 0.87, vertikal: 1.03

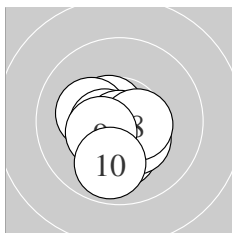
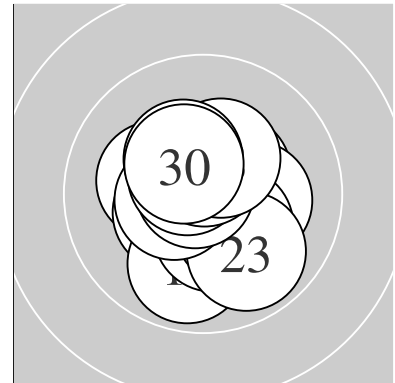

Serie 1:
 10.2 * 10.6 * 10.2 * 10.6 * 10.4 *
 10.6 * 10.8 * 10.5 * 10.4 * 9.9 ↓
 beste Teiler 31.0 (7.) 79.2 (6.) 91.9 (2.)
 Trefferlage 0.30 mm links, 0.67 mm tief
 Streuwert 0.96, horizontal: 0.91, vertikal: 1.01

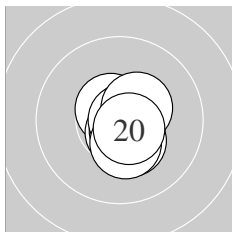

Serie 2:
 10.8 * 10.6 * 10.7 * 10.4 * 10.6 *
 10.7 * 10.8 * 10.4 * 10.4 * 10.6 *
 beste Teiler 27.0 (17.) 34.5 (11.) 52.8 (13.)
 Trefferlage 0.33 mm rechts, 0.27 mm tief
 Streuwert 0.64, horizontal: 0.45, vertikal: 0.79

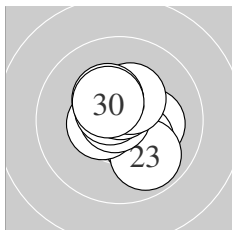

Serie 3:
 10.2 * 10.3 * 9.9 ↘ 10.5 * 10.8 *
 10.6 * 10.5 * 10.4 * 10.4 * 10.4 *
 beste Teiler 36.0 (25.) 90.7 (26.) 102.1 (27.)
 Trefferlage 0.19 mm rechts, 0.18 mm hoch
 Streuwert 1.12, horizontal: 1.07, vertikal: 1.17

Unterschrift des Schützen

Ergebnis: **300.9** (288)
 Serien: 99.0 101.5 100.4
 Zähler: 19 10 1 0 0 0 0 0 0 0
 Innenzehner: 14
 weiteste: 724 (10), 476 (23), 400 (2)
 beste Teiler 26.2 (30.) 27.3 (12.) 78.0 (24.)
 Trefferlage 0.60 mm links, 1.24 mm hoch
 Streuwert 1.68, horizontal: 1.65, vertikal: 1.71

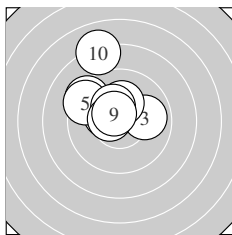
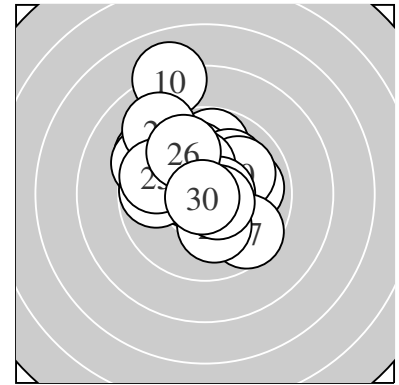

Serie 1:
 10.3 * 9.4 ↘ 9.9 → 10.3 * 9.4 ↘
 10.2 * 10.3 * 10.5 * 10.6 * 8.1 ↑
 beste Teiler 93.8 (9.) 102.6 (8.) 151.3 (4.)
 Trefferlage 1.04 mm links, 1.77 mm hoch
 Streuwert 1.83, horizontal: 1.72, vertikal: 1.94

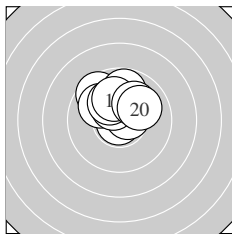

Serie 2:
 9.6 ↘ 10.8 * 10.6 * 9.8 ↑ 10.0 ↘
 10.4 * 10.1 ↘ 10.1 ↑ 10.1 ↗ 10.0 ↗
 beste Teiler 27.3 (12.) 86.3 (13.) 138.1 (16.)
 Trefferlage 0.16 mm links, 1.50 mm hoch
 Streuwert 1.18, horizontal: 1.37, vertikal: 0.96

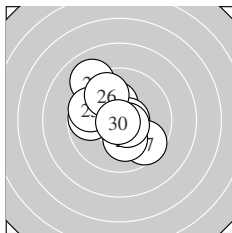

Serie 3:
 10.3 * 9.8 ← 9.0 ↘ 10.6 * 9.7 ↘
 9.8 ↘ 9.6 ↘ 10.2 * 10.6 * 10.8 *
 beste Teiler 26.2 (30.) 78.0 (24.) 90.1 (29.)
 Trefferlage 0.59 mm links, 0.44 mm hoch
 Streuwert 1.88, horizontal: 1.86, vertikal: 1.90

Unterschrift des Schützen

Ergebnis: **290.5** (275)
 Serien: 95.4 99.5 95.6
 Zähler: 11 15 2 2 0 0 0 0 0 0
 Innenzehner: 6
 weiteste: 778 (27), 775 (21), 588 (1)
 beste Teiler 106.3 (11.) 111.2 (24.) 120.9 (28.)
 Trefferlage 0.79 mm links, 1.04 mm tief
 Streuwert 2.40, horizontal: 2.62, vertikal: 2.15

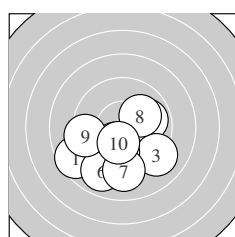
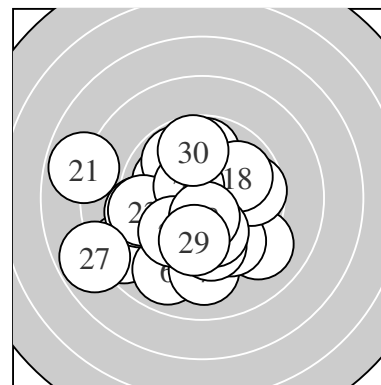

Serie 1:
 8.6 ↙ 9.9 → 9.1 ↘ 10.2 * 9.9 ↓
 8.9 ↘ 9.1 ↓ 10.1 ↗ 9.3 ← 10.3 *
 beste Teiler 171.0 (10.) 189.2 (4.) 221.3 (8.)
 Trefferlage 0.46 mm links, 2.01 mm tief
 Streuwert 2.37, horizontal: 2.72, vertikal: 1.97

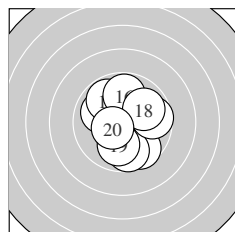

Serie 2:
 10.5 * 9.6 ↘ 10.0 ↖ 9.8 ↖ 9.7 ↓
 9.8 ↑ 9.7 → 9.9 ↗ 10.0 ↓ 10.5 *
 beste Teiler 106.3 (11.) 123.1 (20.) 242.0 (19.)
 Trefferlage 0.25 mm rechts, 0.17 mm tief
 Streuwert 1.92, horizontal: 1.72, vertikal: 2.11

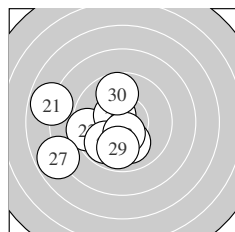

Serie 3:
 7.9 ↖ 10.1 ↓ 9.4 ← 10.5 * 10.0 ↘
 9.8 ↙ 7.8 ← 10.5 * 9.9 ↓ 9.7 ↑
 beste Teiler 111.2 (24.) 120.9 (28.) 225.7 (22.)
 Trefferlage 2.18 mm links, 0.93 mm tief
 Streuwert 2.55, horizontal: 2.89, vertikal: 2.17

Unterschrift des Schützen

Meyton Elektronik

Ergebnis: **302.8** (291)
 Serien: 98.4 103.9 100.5
 Zähler: 21 9 0 0 0 0 0 0 0 0
 Innenzehner: 17
 weiteste: 474 (4), 437 (28), 431 (22)
 beste Teiler 25.3 (21.) 45.1 (18.) 51.9 (11.)
 Trefferlage 0.33 mm links, 0.34 mm tief
 Streuwert 1.77, horizontal: 2.21, vertikal: 1.18

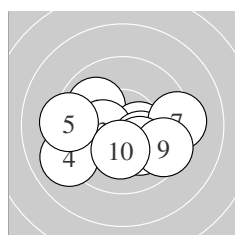
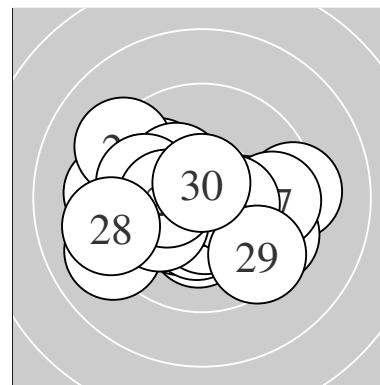

Serie 1:
 10.0 ↖ 10.4 * 10.3 * 9.1 ↙ 9.3 ←
 10.2 * 9.3 → 10.1 ↘ 9.5 ↘ 10.2 *
 beste Teiler 133.1 (2.) 154.1 (3.) 182.4 (6.)
 Trefferlage 0.06 mm links, 0.75 mm tief
 Streuwert 2.18, horizontal: 2.84, vertikal: 1.20

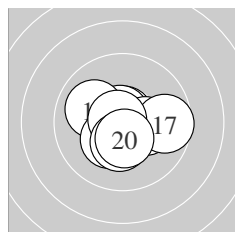

Serie 2:
 10.7 * 10.7 * 10.7 * 10.0 ↖ 10.2 *
 10.3 * 9.7 → 10.8 * 10.3 * 10.5 *
 beste Teiler 45.1 (18.) 51.9 (11.) 53.4 (12.)
 Trefferlage 0.17 mm rechts, 0.24 mm tief
 Streuwert 1.20, horizontal: 1.46, vertikal: 0.86

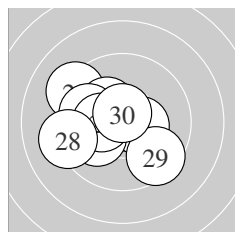

Serie 3:
 10.9 * 9.2 ↖ 10.4 * 10.3 * 9.9 ↙
 10.1 ↙ 10.3 * 9.2 ← 9.5 ↘ 10.7 *
 beste Teiler 25.3 (21.) 69.0 (30.) 134.9 (23.)
 Trefferlage 1.10 mm links, 0.03 mm tief
 Streuwert 1.81, horizontal: 2.14, vertikal: 1.40

Unterschrift des Schützen

Meyton Elektronik

Ergebnis: **308.6** (296)
 Serien: 102.1 101.1 105.4
 Zähler: 26 4 0 0 0 0 0 0 0 0
 Innenzehner: 23
 weiteste: 455 (12), 426 (15), 381 (9)
 beste Teiler 46.0 (13.) 68.1 (22.) 70.4 (23.)
 Trefferlage 0.49 mm links, 0.10 mm tief
 Streuwert 1.34, horizontal: 1.51, vertikal: 1.14

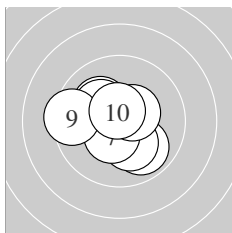
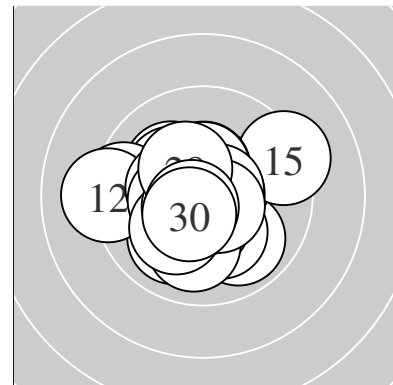

Serie 1:
 10.4 * 10.4 * 10.1 ↖ 9.9 ↘ 10.2 *
 10.2 * 10.4 * 10.5 * 9.4 ← 10.6 *
 beste Teiler 84.1 (10.) 122.0 (8.) 126.0 (1.)
 Trefferlage 0.59 mm links, 0.10 mm hoch
 Streuwert 1.42, horizontal: 1.57, vertikal: 1.24

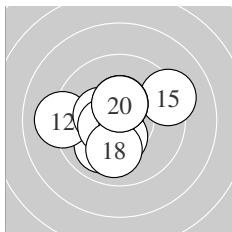

Serie 2:
 10.0 ↙ 9.1 ← 10.8 * 10.3 * 9.2 →
 10.4 * 10.5 * 10.0 ↓ 10.4 * 10.4 *
 beste Teiler 46.0 (13.) 119.2 (17.) 129.0 (20.)
 Trefferlage 0.54 mm links, 0.09 mm tief
 Streuwert 1.77, horizontal: 2.06, vertikal: 1.42

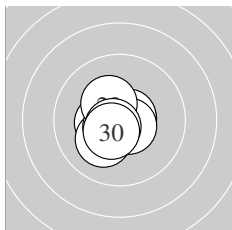

Serie 3:
 10.4 * 10.7 * 10.7 * 10.2 * 10.7 *
 10.6 * 10.6 * 10.3 * 10.7 * 10.5 *
 beste Teiler 68.1 (22.) 70.4 (23.) 71.1 (25.)
 Trefferlage 0.34 mm links, 0.31 mm tief
 Streuwert 0.77, horizontal: 0.80, vertikal: 0.75

Unterschrift des Schützen

Ergebnis: **287.7** (277)
 Serien: 95.4 94.1 98.2
 Zähler: 11 15 4 0 0 0 0 0 0 0
 Innenzehner: 6
 weiteste: 578 (23), 545 (17), 516 (5)
 beste Teiler 107.0 (25.) 130.2 (28.) 139.7 (22.)
 Trefferlage 0.70 mm links, 0.62 mm tief
 Streuwert 2.58, horizontal: 2.86, vertikal: 2.27

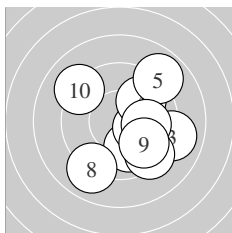
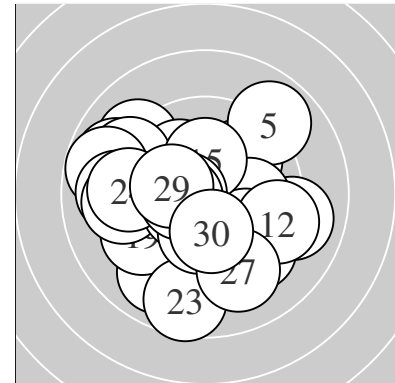

Serie 1:
 10.0 ↘ 10.3 * 9.0 → 9.9 ↗ 8.9 ↗
 10.0 → 9.4 ↘ 9.0 ↙ 9.8 ↘ 9.1 ↖
 beste Teiler 171.4 (2.) 240.8 (6.) 246.0 (1.)
 Trefferlage 1.36 mm rechts, 0.51 mm tief
 Streuwert 2.59, horizontal: 2.57, vertikal: 2.61

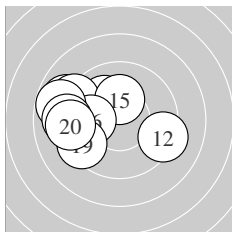

Serie 2:
 8.9 ↖ 9.3 → 10.1 ↖ 9.2 ↖ 10.2 *
 9.9 ← 8.8 ← 9.1 ← 9.4 ↙ 9.2 ←
 beste Teiler 185.0 (15.) 223.2 (13.) 256.0 (16.)
 Trefferlage 2.66 mm links, 0.47 mm hoch
 Streuwert 2.28, horizontal: 2.85, vertikal: 1.50

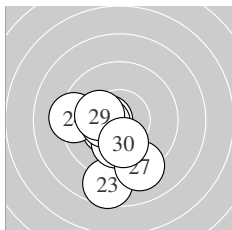

Serie 3:
 9.4 ↓ 10.4 * 8.6 ↓ 9.3 ← 10.5 *
 10.1 ↓ 9.2 ↘ 10.4 * 10.2 * 10.1 ↓
 beste Teiler 107.0 (25.) 130.2 (28.) 139.7 (22.)
 Trefferlage 0.80 mm links, 1.82 mm tief
 Streuwert 1.88, horizontal: 1.59, vertikal: 2.13

Unterschrift des Schützen

Ergebnis: **307.4** (296)
 Serien: 103.6 101.2 102.6
 Zähler: 26 4 0 0 0 0 0 0 0 0
 Innenzehner: 18
 weiteste: 388 (18), 304 (30), 267 (16)
 beste Teiler 30.0 (2.) 51.5 (12.) 52.7 (3.)
 Trefferlage 0.27 mm rechts, 0.17 mm tief
 Streuwert 1.36, horizontal: 1.30, vertikal: 1.41

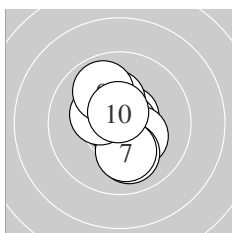
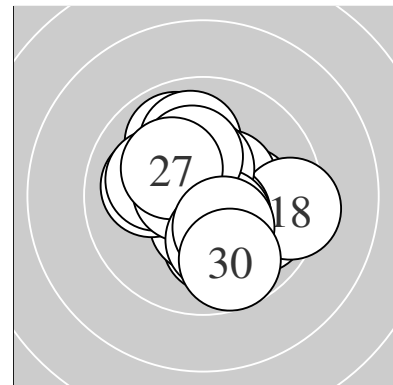

Serie 1:
 10.6 * 10.8 * 10.7 * 10.3 * 10.3 *
 10.0 ↓ 10.1 ↓ 10.3 * 9.9 ↗ 10.6 *
 beste Teiler 30.0 (2.) 52.7 (3.) 81.4 (1.)
 Trefferlage 0.02 mm rechts, 0.06 mm hoch
 Streuwert 1.21, horizontal: 0.88, vertikal: 1.47

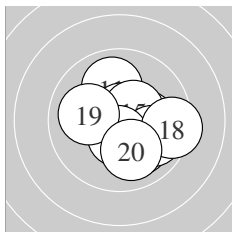

Serie 2:
 10.0 ↑ 10.7 * 10.0 ↘ 10.2 * 10.5 *
 9.9 ↘ 10.5 * 9.4 → 10.0 ← 10.0 ↓
 beste Teiler 51.5 (12.) 117.6 (17.) 121.7 (15.)
 Trefferlage 0.86 mm rechts, 0.29 mm tief
 Streuwert 1.54, horizontal: 1.70, vertikal: 1.36

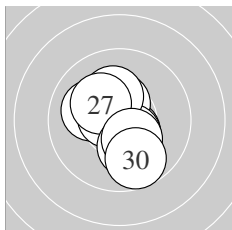

Serie 3:
 10.5 * 10.5 * 10.1 ↖ 10.4 * 10.6 *
 10.2 * 10.2 * 10.1 ↓ 10.3 * 9.7 ↓
 beste Teiler 88.7 (25.) 109.7 (21.) 121.0 (22.)
 Trefferlage 0.05 mm links, 0.28 mm tief
 Streuwert 1.33, horizontal: 1.10, vertikal: 1.53

Unterschrift des Schützen

Ergebnis: **292.6** (283)
 Serien: 96.6 95.6 100.4
 Zähler: 16 11 3 0 0 0 0 0 0 0
 Innenzehner: 12
 weiteste: 660 (18), 599 (4), 547 (5)
 beste Teiler 51.9 (28.) 54.0 (22.) 92.4 (17.)
 Trefferlage 0.64 mm rechts, 0.31 mm tief
 Streuwert 2.39, horizontal: 2.50, vertikal: 2.28

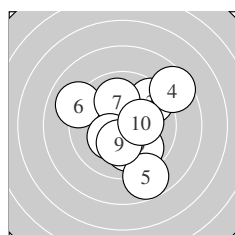
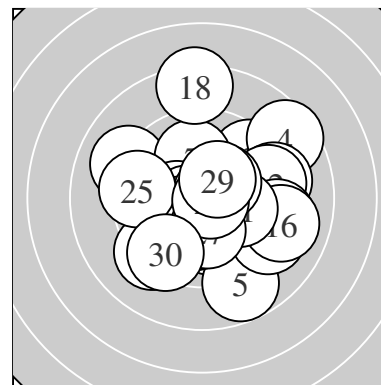

Serie 1:
 10.0 ↓ 9.8 ↘ 9.5 ↗ 8.6 ↗ 8.8 ↓
 9.1 ↖ 10.0 ↑ 10.3 * 10.3 * 10.2 *
 beste Teiler 166.3 (8.) 175.1 (9.) 180.1 (10.)
 Trefferlage 0.75 mm rechts, 0.18 mm tief
 Streuwert 2.62, horizontal: 2.54, vertikal: 2.71

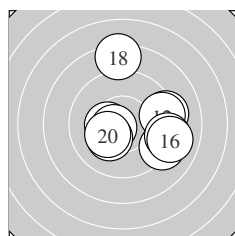

Serie 2:
 9.2 → 9.4 → 9.2 ↘ 9.1 → 10.4 *
 9.0 → 10.6 * 8.3 ↑ 10.2 * 10.2 *
 beste Teiler 92.4 (17.) 148.2 (15.) 177.5 (20.)
 Trefferlage 1.54 mm rechts, 0.08 mm hoch
 Streuwert 2.67, horizontal: 2.81, vertikal: 2.51

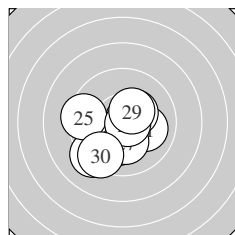

Serie 3:
 10.0 → 10.7 * 10.1 ↓ 9.2 ✓ 9.4 ←
 10.3 * 10.2 * 10.7 * 10.4 * 9.4 ✓
 beste Teiler 51.9 (28.) 54.0 (22.) 141.3 (29.)
 Trefferlage 0.36 mm links, 0.83 mm tief
 Streuwert 1.79, horizontal: 1.95, vertikal: 1.62

Unterschrift des Schützen

Meyton Elektronik

Ergebnis: **301.0** (290)
 Serien: 99.8 100.1 101.1
 Zähler: 21 8 1 0 0 0 0 0 0
 Innenzehner: 12
 weiteste: 587 (4), 396 (24), 389 (17)
 beste Teiler 14.8 (28.) 76.0 (25.) 79.1 (3.)
 Trefferlage 0.14 mm links, 0.88 mm tief
 Streuwert 1.74, horizontal: 1.95, vertikal: 1.50

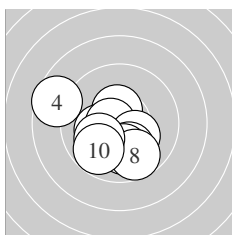
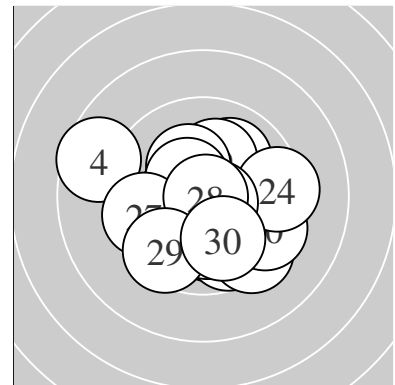

Serie 1:
 10.5 * 10.2 * 10.6 * 8.6 ↖ 10.3 *
 10.0 ↓ 10.0 ↓ 9.7 ↓ 10.1 ↙ 9.8 ↙
 beste Teiler 79.1 (3.) 117.2 (1.) 175.4 (5.)
 Trefferlage 0.81 mm links, 0.95 mm tief
 Streuwert 1.85, horizontal: 2.09, vertikal: 1.57

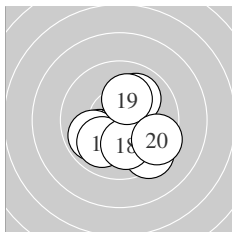

Serie 2:
 10.4 * 10.0 ↗ 10.1 ↙ 10.5 * 9.9 ↙
 10.0 ↙ 9.4 ↘ 10.1 ↓ 10.2 * 9.5 ↘
 beste Teiler 103.1 (14.) 127.6 (11.) 197.0 (19.)
 Trefferlage 0.34 mm rechts, 0.96 mm tief
 Streuwert 1.73, horizontal: 1.85, vertikal: 1.60

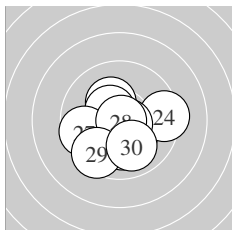

Serie 3:
 10.3 * 10.2 * 10.1 ↓ 9.4 → 10.6 *
 10.5 * 9.6 ← 10.9 * 9.5 ↙ 10.0 ↓
 beste Teiler 14.8 (28.) 76.0 (25.) 118.7 (26.)
 Trefferlage 0.04 mm rechts, 0.73 mm tief
 Streuwert 1.71, horizontal: 1.93, vertikal: 1.46

Unterschrift des Schützen

Ergebnis: **303.7** (289)
 Serien: 98.8 101.6 103.3
 Zähler: 20 9 1 0 0 0 0 0 0 0
 Innenzehner: 15
 weiteste: 522 (6), 431 (16), 356 (9)
 beste Teiler 17.2 (27.) 31.0 (13.) 59.3 (2.)
 Trefferlage 0.28 mm rechts, 0.75 mm hoch
 Streuwert 1.61, horizontal: 1.88, vertikal: 1.28

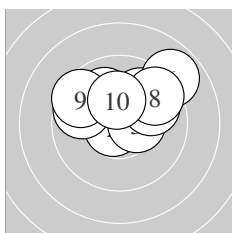
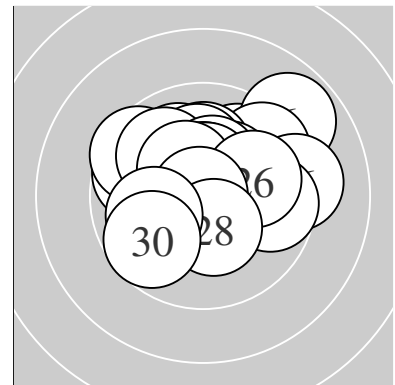

Serie 1:
 10.0 ↘ 10.7 * 10.4 * 9.9 ↗ 9.7 ↖
 8.9 ↗ 9.9 ↗ 9.6 ↗ 9.5 ↖ 10.2 *
 beste Teiler 59.3 (2.) 131.0 (3.) 179.4 (10.)
 Trefferlage 0.41 mm rechts, 1.53 mm hoch
 Streuwert 1.85, horizontal: 2.37, vertikal: 1.10

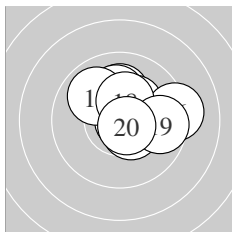

Serie 2:
 10.1 ↑ 10.1 ↑ 10.8 * 10.3 * 9.9 ↖
 9.2 → 10.5 * 10.3 * 9.7 → 10.7 *
 beste Teiler 31.0 (13.) 69.8 (20.) 120.2 (17.)
 Trefferlage 0.86 mm rechts, 0.77 mm hoch
 Streuwert 1.44, horizontal: 1.71, vertikal: 1.11

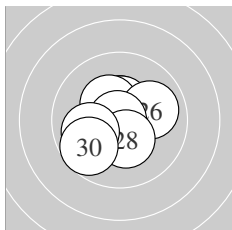

Serie 3:
 10.7 * 10.5 * 10.5 * 10.4 * 10.3 *
 10.0 → 10.9 * 10.3 * 10.0 ← 9.7 ↙
 beste Teiler 17.2 (27.) 67.2 (21.) 116.7 (23.)
 Trefferlage 0.42 mm links, 0.04 mm tief
 Streuwert 1.30, horizontal: 1.37, vertikal: 1.22

Unterschrift des Schützen

Ergebnis: **301.2** (286)
 Serien: 100.2 99.1 101.9
 Zähler: 17 12 1 0 0 0 0 0 0 0
 Innenzehner: 14
 weiteste: 541 (13), 416 (15), 401 (8)
 beste Teiler 51.8 (26.) 53.1 (23.) 61.2 (29.)
 Trefferlage 0.19 mm links, 0.33 mm hoch
 Streuwert 1.83, horizontal: 2.17, vertikal: 1.41

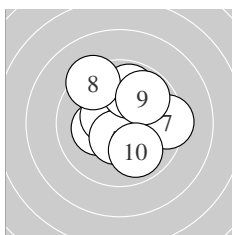
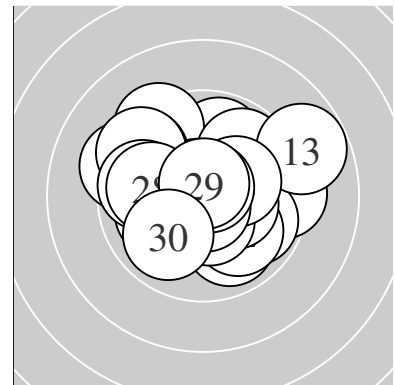

Serie 1:
 10.4 * 10.2 * 10.3 * 10.5 * 10.5 *
 9.9 ↗ 9.4 → 9.3 ↘ 9.8 ↗ 9.9 ↘
 beste Teiler 117.7 (4.) 121.2 (5.) 135.1 (1.)
 Trefferlage 0.35 mm rechts, 0.57 mm hoch
 Streuwert 1.82, horizontal: 1.87, vertikal: 1.76

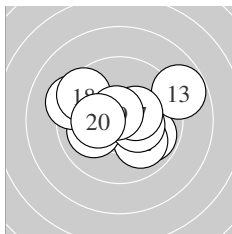

Serie 2:
 9.9 ↘ 10.0 ↘ 8.8 ↗ 10.0 ↙ 9.3 ↖
 10.3 * 10.4 * 9.5 ↖ 10.7 * 10.2 *
 beste Teiler 65.3 (19.) 143.3 (17.) 155.5 (16.)
 Trefferlage 0.08 mm rechts, 0.27 mm hoch
 Streuwert 2.19, horizontal: 2.76, vertikal: 1.38

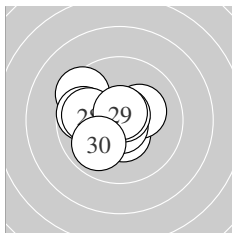

Serie 3:
 10.5 * 10.2 * 10.7 * 9.5 ↖ 10.1 ←
 10.7 * 9.7 ← 9.9 ← 10.7 * 9.9 ↗
 beste Teiler 51.8 (26.) 53.1 (23.) 61.2 (29.)
 Trefferlage 1.01 mm links, 0.14 mm hoch
 Streuwert 1.43, horizontal: 1.68, vertikal: 1.13

Unterschrift des Schützen

Ergebnis: **306.0** (292)
 Serien: 102.2 103.3 100.5
 Zähler: 22 8 0 0 0 0 0 0 0 0
 Innenzehner: 18
 weiteste: 473 (24), 409 (13), 387 (21)
 beste Teiler 48.2 (17.) 60.5 (6.) 61.5 (14.)
 Trefferlage 0.67 mm links, 0.36 mm tief
 Streuwert 1.50, horizontal: 1.44, vertikal: 1.55

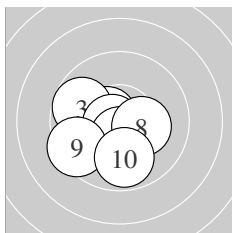
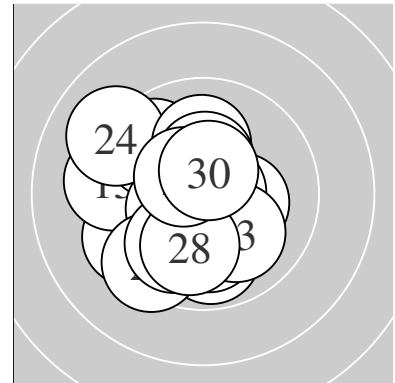

Serie 1:
 10.5 * 10.4 * 9.7 ↖ 10.5 * 10.2 *
 10.7 * 10.5 * 10.3 * 9.5 ↙ 9.9 ↓
 beste Teiler 60.5 (6.) 101.5 (1.) 116.0 (7.)
 Trefferlage 0.43 mm links, 0.93 mm tief
 Streuwert 1.35, horizontal: 1.54, vertikal: 1.15

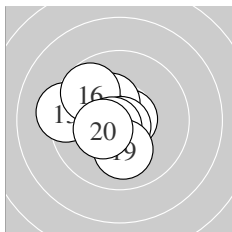

Serie 2:
 10.5 * 10.7 * 9.3 ← 10.7 * 10.4 *
 9.7 ↘ 10.8 * 10.7 * 10.1 ↓ 10.4 *
 beste Teiler 48.2 (17.) 61.5 (14.) 72.8 (12.)
 Trefferlage 0.86 mm links, 0.13 mm tief
 Streuwert 1.30, horizontal: 1.38, vertikal: 1.22

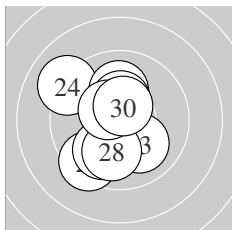

Serie 3:
 9.4 ↙ 9.9 ↙ 10.0 ↘ 9.1 ↖ 10.1 ↑
 10.6 * 10.4 * 10.0 ↓ 10.5 * 10.5 *
 beste Teiler 98.0 (26.) 108.9 (30.) 116.9 (29.)
 Trefferlage 0.73 mm links, 0.02 mm tief
 Streuwert 1.83, horizontal: 1.52, vertikal: 2.10

Unterschrift des Schützen

Meyton Elektronik

Ergebnis: **298.1** (285)
 Serien: 99.6 98.5 100.0
 Zähler: 17 11 2 0 0 0 0 0 0 0
 Innenzehner: 12
 weiteste: 620 (30), 600 (5), 489 (19)
 beste Teiler 71.1 (26.) 75.2 (25.) 87.1 (9.)
 Trefferlage 0.60 mm rechts, 0.66 mm hoch
 Streuwert 2.00, horizontal: 2.24, vertikal: 1.73

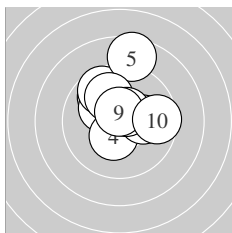
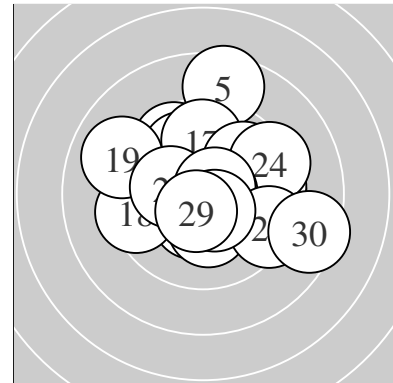

Serie 1:
 9.9 ↘ 10.2 * 9.7 ↘ 10.4 * 8.6 ↑
 10.1 → 10.0 ↘ 10.5 * 10.6 * 9.6 →
 beste Teiler 87.1 (9.) 105.2 (8.) 144.8 (4.)
 Trefferlage 0.09 mm rechts, 1.50 mm hoch
 Streuwert 1.85, horizontal: 1.73, vertikal: 1.96

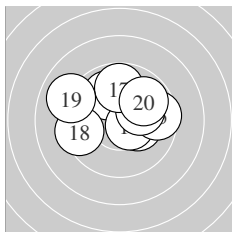

Serie 2:
 10.3 * 10.1 ↑ 9.9 ↘ 10.5 * 9.6 →
 10.1 → 9.8 ↑ 9.4 ← 9.0 ↖ 9.8 ↗
 beste Teiler 106.0 (14.) 174.5 (11.) 207.6 (16.)
 Trefferlage 0.16 mm rechts, 1.01 mm hoch
 Streuwert 2.05, horizontal: 2.56, vertikal: 1.37

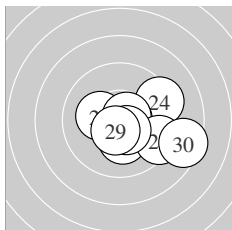

Serie 3:
 10.1 → 10.2 * 10.2 * 9.3 → 10.7 *
 10.7 * 9.3 ↘ 10.5 * 10.5 * 8.5 ↘
 beste Teiler 71.1 (26.) 75.2 (25.) 102.3 (29.)
 Trefferlage 1.55 mm rechts, 0.53 mm tief
 Streuwert 1.82, horizontal: 2.27, vertikal: 1.20

Unterschrift des Schützen

Ergebnis: **295.1** (283)
 Serien: 99.4 97.4 98.3
 Zähler: 14 15 1 0 0 0 0 0 0 0
 Innenzehner: 8
 weiteste: 619 (21), 428 (20), 421 (17)
 beste Teiler 111.4 (5.) 161.2 (24.) 169.2 (3.)
 Trefferlage 0.50 mm links, 0.65 mm tief
 Streuwert 2.05, horizontal: 2.43, vertikal: 1.57

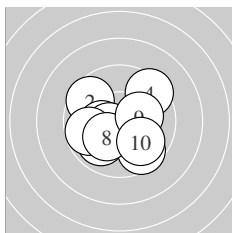
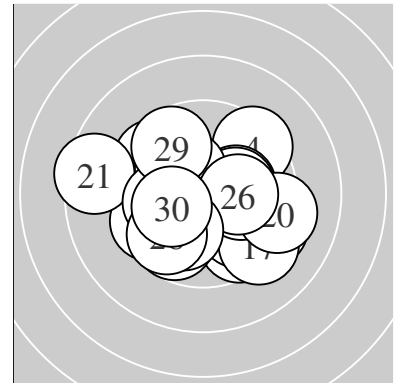

Serie 1:
 9.9 ↙ 9.6 ↘ 10.3 * 9.4 ↗ 10.5 *
 9.6 ↘ 9.8 ← 10.2 * 10.2 * 9.9 ↘
 beste Teiler 111.4 (5.) 169.2 (3.) 188.2 (8.)
 Trefferlage 0.25 mm links, 0.47 mm tief
 Streuwert 1.96, horizontal: 2.16, vertikal: 1.72

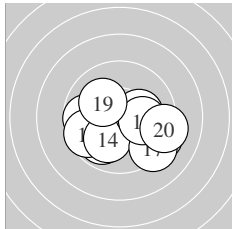

Serie 2:
 9.7 ← 9.9 ↙ 9.6 ← 10.0 ↙ 9.3 ↘
 10.2 * 9.3 ↘ 10.1 → 10.1 ↘ 9.2 →
 beste Teiler 184.3 (16.) 209.0 (19.) 216.5 (18.)
 Trefferlage 0.45 mm rechts, 1.01 mm tief
 Streuwert 2.19, horizontal: 2.80, vertikal: 1.31

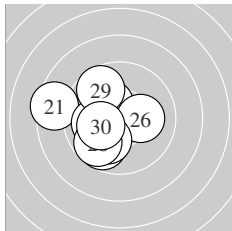

Serie 3:
 8.5 ← 9.7 ↙ 10.0 ↙ 10.3 * 10.0 ←
 10.2 * 10.0 ↙ 9.7 ↙ 9.7 ↘ 10.2 *
 beste Teiler 161.2 (24.) 189.7 (30.) 196.0 (26.)
 Trefferlage 1.71 mm links, 0.47 mm tief
 Streuwert 1.85, horizontal: 1.94, vertikal: 1.75

Unterschrift des Schützen

Ergebnis: **312.6** (297)
 Serien: 103.5 103.5 105.6
 Zähler: 27 3 0 0 0 0 0 0 0 0
 Innenzehner: 26
 weiteste: 293 (19), 272 (23), 263 (8)
 beste Teiler 18.9 (29.) 30.0 (26.) 43.4 (24.)
 Trefferlage 0.24 mm rechts, 0.09 mm tief
 Streuwert 1.08, horizontal: 1.10, vertikal: 1.06

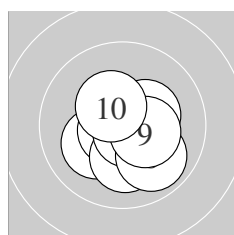
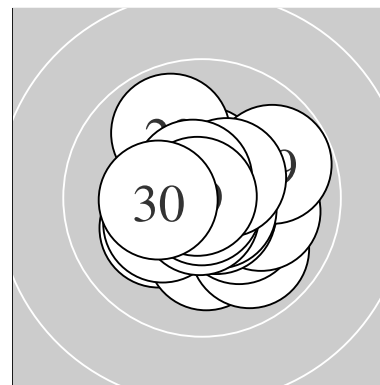

Serie 1:
 10.2 * 10.3 * 10.4 * 10.7 * 10.2 *
 10.3 * 10.7 * 9.9 ↘ 10.4 * 10.4 *
 beste Teiler 55.3 (7.) 68.0 (4.) 139.6 (10.)
 Trefferlage 0.32 mm rechts, 0.72 mm tief
 Streuwert 1.07, horizontal: 1.09, vertikal: 1.06

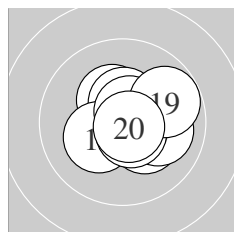

Serie 2:
 10.4 * 10.3 * 10.3 * 10.5 * 10.2 *
 10.6 * 10.0 → 10.6 * 9.8 ↗ 10.8 *
 beste Teiler 49.4 (20.) 80.1 (16.) 82.9 (18.)
 Trefferlage 0.70 mm rechts, 0.08 mm hoch
 Streuwert 1.12, horizontal: 1.27, vertikal: 0.95

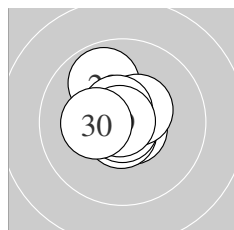

Serie 3:
 10.4 * 10.7 * 9.9 ↖ 10.8 * 10.7 *
 10.8 * 10.5 * 10.6 * 10.9 * 10.3 *
 beste Teiler 18.9 (29.) 30.0 (26.) 43.4 (24.)
 Trefferlage 0.29 mm links, 0.36 mm hoch
 Streuwert 0.85, horizontal: 0.75, vertikal: 0.94

Unterschrift des Schützen

Ergebnis: **311.8** (300)
 Serien: 104.3 104.4 103.1
 Zähler: 30 0 0 0 0 0 0 0 0 0
 Innenzehner: 26
 weiteste: 236 (8), 226 (26), 222 (16)
 beste Teiler 36.7 (1.) 40.5 (24.) 47.2 (10.)
 Trefferlage 0.07 mm links, 0.12 mm tief
 Streuwert 1.10, horizontal: 1.09, vertikal: 1.10

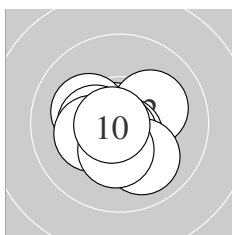
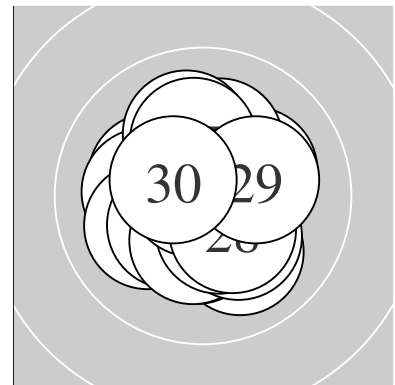

Serie 1:
 10.8 * 10.2 * 10.2 * 10.4 * 10.3 *
 10.6 * 10.7 * 10.0 ↘ 10.3 * 10.8 *
 beste Teiler 36.7 (1.) 47.2 (10.) 65.0 (7.)
 Trefferlage 0.24 mm links, 0.39 mm tief
 Streuwert 1.06, horizontal: 1.19, vertikal: 0.91

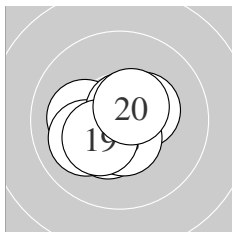

Serie 2:
 10.4 * 10.7 * 10.4 * 10.7 * 10.1 ←
 10.1 ← 10.7 * 10.5 * 10.3 * 10.5 *
 beste Teiler 58.2 (12.) 62.7 (17.) 72.9 (14.)
 Trefferlage 0.23 mm links, 0.15 mm tief
 Streuwert 1.01, horizontal: 1.16, vertikal: 0.83

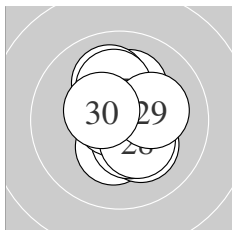

Serie 3:
 10.3 * 10.2 * 10.4 * 10.8 * 10.2 *
 10.0 ↑ 10.2 * 10.3 * 10.2 * 10.5 *
 beste Teiler 40.5 (24.) 120.3 (30.) 133.7 (23.)
 Trefferlage 0.25 mm rechts, 0.18 mm hoch
 Streuwert 1.24, horizontal: 0.94, vertikal: 1.49

Unterschrift des Schützen

Ergebnis: **300.7** (289)
 Serien: 102.2 100.3 98.2
 Zähler: 19 11 0 0 0 0 0 0 0 0
 Innenzehner: 10
 weiteste: 418 (22), 382 (28), 351 (24)
 beste Teiler 69.4 (7.) 117.8 (10.) 131.7 (18.)
 Trefferlage 0.22 mm links, 1.51 mm hoch
 Streuwert 1.39, horizontal: 1.47, vertikal: 1.30

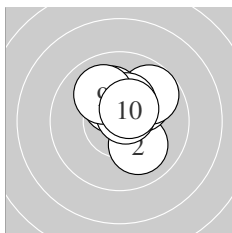
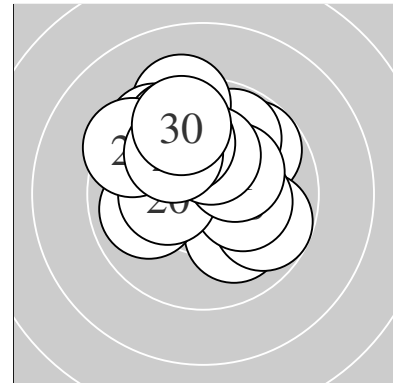

Serie 1:
 10.2 * 10.0 ↘ 10.1 ↗ 9.8 ↗ 10.1 ↖
 10.4 * 10.7 * 10.4 * 10.0 ↖ 10.5 *
 beste Teiler 69.4 (7.) 117.8 (10.) 145.0 (6.)
 Trefferlage 0.58 mm rechts, 1.12 mm hoch
 Streuwert 1.11, horizontal: 1.10, vertikal: 1.12

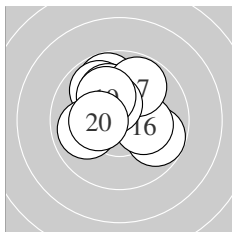

Serie 2:
 9.8 ↖ 9.9 ↖ 9.8 ↘ 9.9 ← 10.1 ↖
 10.2 * 9.8 ↗ 10.4 * 10.1 ↖ 10.3 *
 beste Teiler 131.7 (18.) 160.1 (20.) 184.3 (16.)
 Trefferlage 0.30 mm links, 1.02 mm hoch
 Streuwert 1.58, horizontal: 1.68, vertikal: 1.48

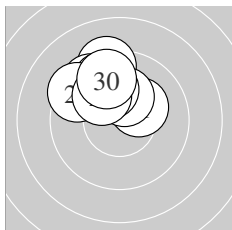

Serie 3:
 10.3 * 9.3 ↖ 10.1 ↖ 9.5 ↖ 10.2 *
 10.0 ↖ 9.7 ↖ 9.4 ↖ 10.0 ↖ 9.7 ↖
 beste Teiler 175.0 (21.) 179.8 (25.) 208.3 (23.)
 Trefferlage 0.94 mm links, 2.38 mm hoch
 Streuwert 1.09, horizontal: 1.27, vertikal: 0.86

Unterschrift des Schützen

Ergebnis: **301.7** (290)
 Serien: 99.8 99.7 102.2
 Zähler: 21 8 1 0 0 0 0 0 0 0
 Innenzehner: 12
 weiteste: 507 (16), 348 (2), 347 (3)
 beste Teiler 52.9 (18.) 58.5 (30.) 120.2 (22.)
 Trefferlage 0.11 mm rechts, 0.42 mm hoch
 Streuwert 1.73, horizontal: 1.73, vertikal: 1.74

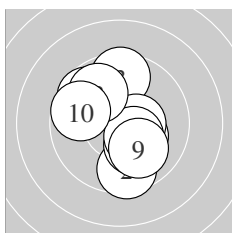
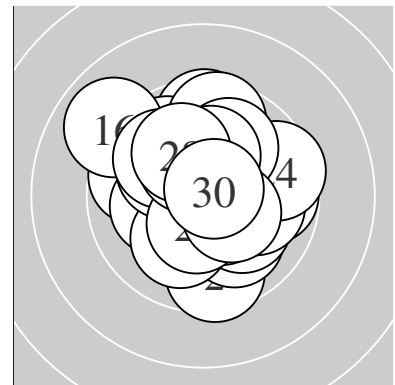

Serie 1:
 10.3 * 9.6 ↓ 9.6 ↑ 10.5 * 10.2 *
 10.4 * 9.7 ↘ 9.8 ↘ 10.0 ↘ 9.7 ↖
 beste Teiler 124.1 (4.) 145.0 (6.) 171.9 (1.)
 Trefferlage 0.02 mm links, 0.03 mm tief
 Streuwert 1.93, horizontal: 1.68, vertikal: 2.16

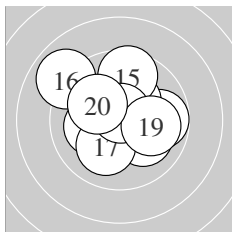

Serie 2:
 10.1 ↘ 9.8 → 10.3 * 10.1 ← 9.6 ↑
 8.9 ↘ 10.1 ↙ 10.7 * 10.0 → 10.1 ↘
 beste Teiler 52.9 (18.) 165.8 (13.) 201.3 (14.)
 Trefferlage 0.00 mm , 0.55 mm hoch
 Streuwert 1.96, horizontal: 2.18, vertikal: 1.73

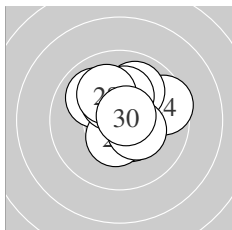

Serie 3:
 10.0 ↘ 10.5 * 10.4 * 9.6 → 10.3 *
 10.0 ↗ 10.2 * 10.1 ↘ 10.4 * 10.7 *
 beste Teiler 58.5 (30.) 120.2 (22.) 128.5 (23.)
 Trefferlage 0.36 mm rechts, 0.76 mm hoch
 Streuwert 1.37, horizontal: 1.43, vertikal: 1.30

Unterschrift des Schützen

Ergebnis: **306.4** (293)
 Serien: 101.6 103.8 101.0
 Zähler: 23 7 0 0 0 0 0 0 0 0
 Innenzehner: 18
 weiteste: 342 (28), 341 (23), 296 (24)
 beste Teiler 8.0 (6.) 25.0 (15.) 26.2 (16.)
 Trefferlage 0.68 mm links, 0.34 mm tief
 Streuwert 1.36, horizontal: 1.42, vertikal: 1.30

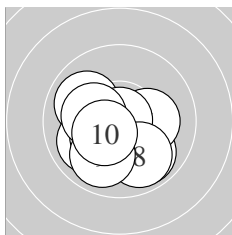
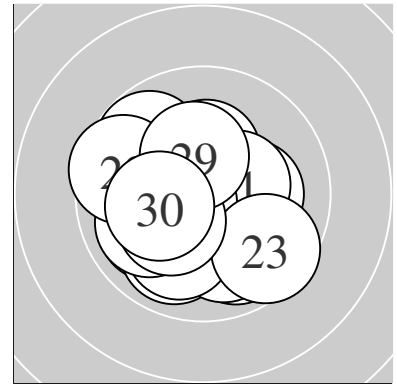

Serie 1:
 9.9 ↘ 9.9 ↖ 10.0 ← 10.3 * 10.2 *
 10.9 * 10.2 * 9.9 ↘ 9.9 ↙ 10.4 *
 beste Teiler 8.0 (6.) 130.4 (10.) 159.9 (4.)
 Trefferlage 0.45 mm links, 0.83 mm tief
 Streuwert 1.41, horizontal: 1.57, vertikal: 1.22

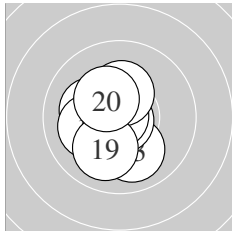

Serie 2:
 10.4 * 10.2 * 10.0 ↓ 10.8 * 10.9 *
 10.8 * 10.3 * 10.1 ← 10.0 ↙ 10.3 *
 beste Teiler 25.0 (15.) 26.2 (16.) 45.0 (14.)
 Trefferlage 0.62 mm links, 0.05 mm tief
 Streuwert 1.12, horizontal: 0.89, vertikal: 1.31

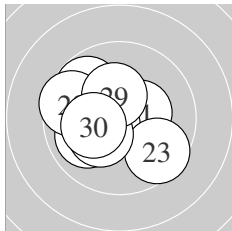

Serie 3:
 10.4 * 10.6 * 9.6 ↘ 9.8 ↖ 10.2 *
 10.0 ← 10.3 * 9.6 ← 10.3 * 10.2 *
 beste Teiler 93.5 (22.) 139.9 (21.) 159.1 (29.)
 Trefferlage 0.97 mm links, 0.14 mm tief
 Streuwert 1.57, horizontal: 1.76, vertikal: 1.34

Unterschrift des Schützen

Ergebnis: **307.9** (299)
 Serien: 102.7 102.9 102.3
 Zähler: 29 1 0 0 0 0 0 0 0 0
 Innenzehner: 20
 weiteste: 274 (6), 248 (7), 247 (3)
 beste Teiler 17.0 (10.) 82.2 (1.) 87.1 (27.)
 Trefferlage 0.46 mm rechts, 0.14 mm hoch
 Streuwert 1.27, horizontal: 1.29, vertikal: 1.25

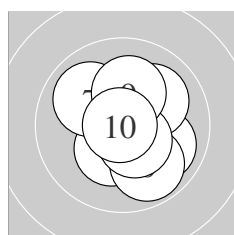
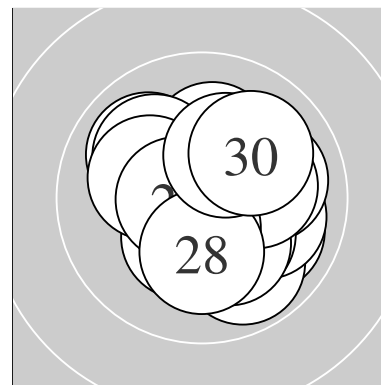

Serie 1:
 10.6 * 10.3 * 10.0 ↘ 10.3 * 10.0 ↗
 9.9 ↘ 10.0 ↖ 10.5 * 10.2 * 10.9 *
 beste Teiler 17.0 (10.) 82.2 (1.) 117.4 (8.)
 Trefferlage 0.39 mm rechts, 0.15 mm hoch
 Streuwert 1.38, horizontal: 1.23, vertikal: 1.52

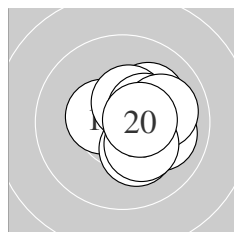

Serie 2:
 10.1 ↗ 10.5 * 10.4 * 10.0 → 10.5 *
 10.2 * 10.4 * 10.0 → 10.3 * 10.5 *
 beste Teiler 104.9 (20.) 123.4 (12.) 124.3 (15.)
 Trefferlage 1.08 mm rechts, 0.11 mm hoch
 Streuwert 1.00, horizontal: 0.99, vertikal: 1.00

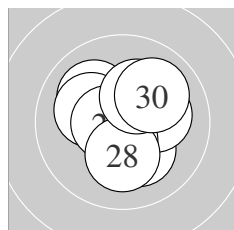

Serie 3:
 10.2 * 10.2 * 10.0 ↖ 10.2 * 10.5 *
 10.1 ↖ 10.6 * 10.2 * 10.3 * 10.0 ↗
 beste Teiler 87.1 (27.) 108.7 (25.) 175.9 (29.)
 Trefferlage 0.08 mm links, 0.18 mm hoch
 Streuwert 1.38, horizontal: 1.44, vertikal: 1.32

Unterschrift des Schützen

Meyton Elektronik

Ergebnis: **309.1** (296)
 Serien: 103.7 104.0 101.4
 Zähler: 26 4 0 0 0 0 0 0 0 0
 Innenzehner: 24
 weiteste: 470 (24), 359 (5), 290 (14)
 beste Teiler 11.0 (3.) 17.8 (12.) 60.0 (17.)
 Trefferlage 0.08 mm rechts, 0.27 mm tief
 Streuwert 1.33, horizontal: 0.93, vertikal: 1.63

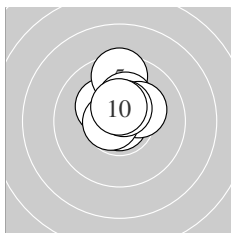
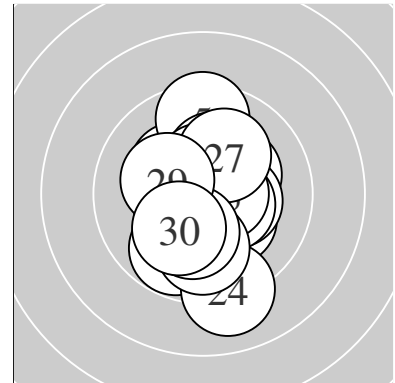

Serie 1:
 10.4 * 10.4 * 10.9 * 10.3 * 9.5 ↑
 10.3 * 10.2 * 10.7 * 10.5 * 10.5 *
 beste Teiler 11.0 (3.) 71.3 (8.) 107.5 (9.)
 Trefferlage 0.03 mm rechts, 1.14 mm hoch
 Streuwert 0.94, horizontal: 0.85, vertikal: 1.02

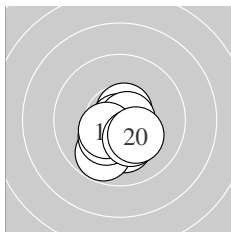

Serie 2:
 10.6 * 10.9 * 10.2 * 9.8 ✓ 10.5 *
 10.3 * 10.7 * 10.4 * 10.3 * 10.3 *
 beste Teiler 17.8 (12.) 60.0 (17.) 79.6 (11.)
 Trefferlage 0.02 mm rechts, 0.99 mm tief
 Streuwert 0.93, horizontal: 0.88, vertikal: 0.98

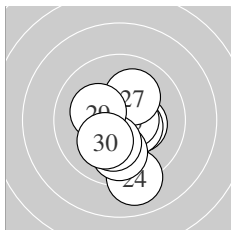

Serie 3:
 10.3 * 10.5 * 10.4 * 9.1 ↓ 10.6 *
 9.9 ↓ 10.1 ↗ 10.2 * 10.2 * 10.1 ✓
 beste Teiler 90.0 (25.) 119.8 (22.) 131.3 (23.)
 Trefferlage 0.18 mm rechts, 0.99 mm tief
 Streuwert 1.50, horizontal: 1.14, vertikal: 1.79

Unterschrift des Schützen

Ergebnis: **306.2** (294)
 Serien: 100.7 103.6 101.9
 Zähler: 24 6 0 0 0 0 0 0 0 0
 Innenzehner: 21
 weiteste: 377 (9), 349 (8), 312 (30)
 beste Teiler 100.5 (21.) 101.0 (18.) 104.2 (7.)
 Trefferlage 0.70 mm rechts, 0.43 mm tief
 Streuwert 1.31, horizontal: 1.56, vertikal: 0.99

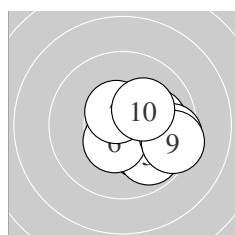
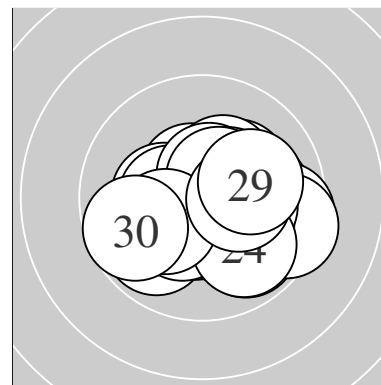

Serie 1:
 10.0 → 10.0 → 10.5 * 10.2 * 9.9 ↘
 10.4 * 10.5 * 9.6 → 9.4 → 10.2 *
 beste Teiler 104.2 (7.) 120.5 (3.) 127.4 (6.)
 Trefferlage 1.58 mm rechts, 0.51 mm tief
 Streuwert 1.27, horizontal: 1.44, vertikal: 1.06

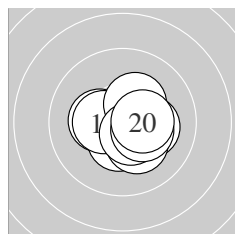

Serie 2:
 10.5 * 10.3 * 10.4 * 10.4 * 10.3 *
 10.2 * 10.3 * 10.5 * 10.3 * 10.4 *
 beste Teiler 101.0 (18.) 118.7 (11.) 128.0 (13.)
 Trefferlage 0.49 mm rechts, 0.35 mm tief
 Streuwert 1.00, horizontal: 1.19, vertikal: 0.78

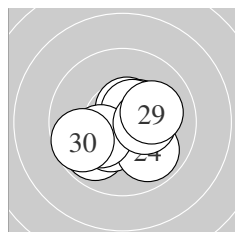

Serie 3:
 10.6 * 9.9 ↙ 10.3 * 9.9 ↘ 10.4 *
 10.5 * 10.2 * 10.3 * 10.1 → 9.7 ←
 beste Teiler 100.5 (21.) 105.5 (26.) 134.0 (25.)
 Trefferlage 0.03 mm rechts, 0.43 mm tief
 Streuwert 1.48, horizontal: 1.72, vertikal: 1.19

Unterschrift des Schützen

Meyton Elektronik

Ergebnis: **309.5** (296)
 Serien: 103.6 103.3 102.6
 Zähler: 26 4 0 0 0 0 0 0 0 0
 Innenzehner: 23
 weiteste: 454 (29), 344 (19), 277 (25)
 beste Teiler 43.6 (12.) 53.0 (26.) 60.9 (4.)
 Trefferlage 0.36 mm links, 0.65 mm tief
 Streuwert 1.21, horizontal: 1.39, vertikal: 1.01

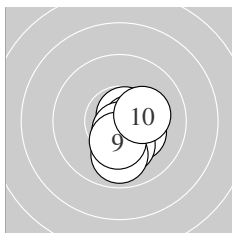
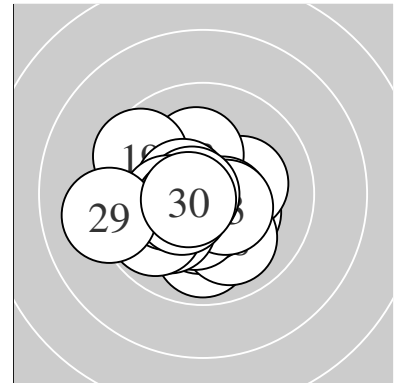

Serie 1:
 10.5 * 10.2 * 10.3 * 10.7 * 10.6 *
 10.7 * 10.2 * 9.9 ↓ 10.3 * 10.2 *
 beste Teiler 60.9 (4.) 72.3 (6.) 88.8 (5.)
 Trefferlage 0.55 mm rechts, 0.98 mm tief
 Streuwert 0.86, horizontal: 0.63, vertikal: 1.04

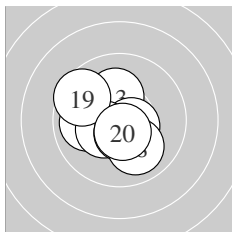

Serie 2:
 10.7 * 10.8 * 10.2 * 10.5 * 10.0 ←
 10.4 * 10.5 * 10.0 ↘ 9.6 ↖ 10.6 *
 beste Teiler 43.6 (12.) 69.1 (11.) 95.0 (20.)
 Trefferlage 0.39 mm links, 0.28 mm tief
 Streuwert 1.31, horizontal: 1.40, vertikal: 1.22

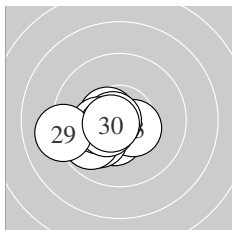

Serie 3:
 10.4 * 10.5 * 10.5 * 10.1 ↙ 9.8 ↘
 10.7 * 10.3 * 10.5 * 9.1 ← 10.7 *
 beste Teiler 53.0 (26.) 74.0 (30.) 102.1 (22.)
 Trefferlage 1.24 mm links, 0.71 mm tief
 Streuwert 1.11, horizontal: 1.43, vertikal: 0.66

Unterschrift des Schützen

Ergebnis: **307.1** (294)
 Serien: 103.0 101.6 102.5
 Zähler: 24 6 0 0 0 0 0 0 0 0
 Innenzehner: 19
 weiteste: 360 (11), 312 (14), 302 (28)
 beste Teiler 34.0 (7.) 51.0 (19.) 85.0 (13.)
 Trefferlage 0.20 mm rechts, 0.47 mm tief
 Streuwert 1.36, horizontal: 1.58, vertikal: 1.10

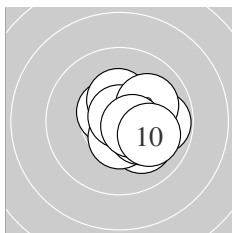
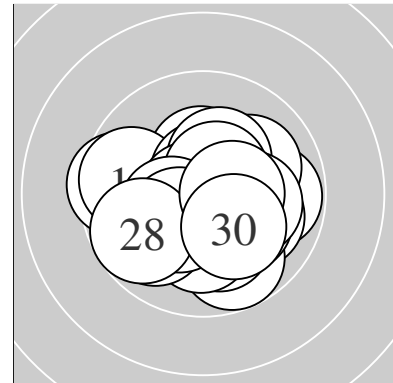

Serie 1:
 10.1 ↘ 10.5 * 9.8 → 10.4 * 10.5 *
 10.3 * 10.8 * 10.0 ↗ 10.6 * 10.0 ↘
 beste Teiler 34.0 (7.) 96.5 (9.) 104.6 (2.)
 Trefferlage 0.99 mm rechts, 0.12 mm tief
 Streuwert 1.10, horizontal: 1.18, vertikal: 1.01

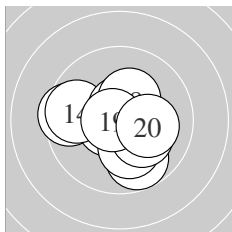

Serie 2:
 9.5 ← 9.8 ↘ 10.6 * 9.7 ← 10.1 ↘
 10.2 * 10.6 * 10.3 * 10.7 * 10.1 →
 beste Teiler 51.0 (19.) 85.0 (13.) 86.0 (17.)
 Trefferlage 0.17 mm links, 0.31 mm tief
 Streuwert 1.61, horizontal: 1.88, vertikal: 1.29

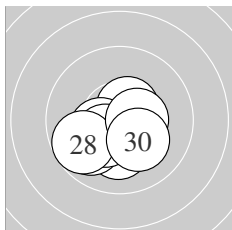

Serie 3:
 10.3 * 10.5 * 10.2 * 9.9 ↙ 10.4 *
 10.4 * 10.4 * 9.7 ↙ 10.5 * 10.2 *
 beste Teiler 101.7 (22.) 124.0 (29.) 142.0 (27.)
 Trefferlage 0.20 mm links, 0.98 mm tief
 Streuwert 1.19, horizontal: 1.44, vertikal: 0.87

Unterschrift des Schützen

Ergebnis: **308.6** (292)
 Serien: 101.6 100.6 106.4
 Zähler: 23 6 1 0 0 0 0 0 0 0
 Innenzehner: 22
 weiteste: 526 (17), 341 (10), 308 (7)
 beste Teiler 7.0 (21.) 25.7 (27.) 40.3 (23.)
 Trefferlage 0.21 mm links, 0.44 mm tief
 Streuwert 1.42, horizontal: 1.57, vertikal: 1.24

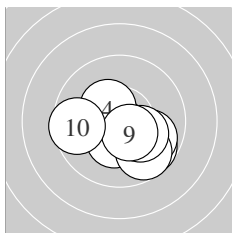
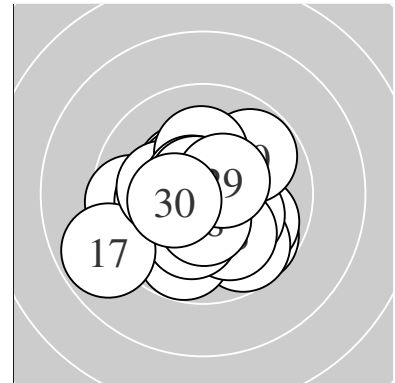

Serie 1:
 10.6 * 10.7 * 10.3 * 10.4 * 9.7 ↘
 9.9 ↘ 9.7 ↘ 10.2 * 10.5 * 9.6 ←
 beste Teiler 58.4 (2.) 97.4 (1.) 120.5 (9.)
 Trefferlage 0.35 mm rechts, 0.95 mm tief
 Streuwert 1.46, horizontal: 1.82, vertikal: 0.97

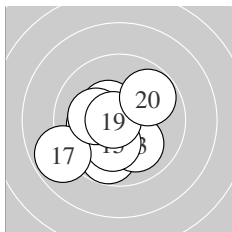

Serie 2:
 9.8 ↓ 10.4 * 10.0 ↘ 10.2 * 10.2 *
 10.4 * 8.8 ↙ 10.2 * 10.8 * 9.8 ↗
 beste Teiler 50.0 (19.) 128.7 (16.) 149.4 (12.)
 Trefferlage 0.91 mm links, 0.61 mm tief
 Streuwert 1.72, horizontal: 1.84, vertikal: 1.59

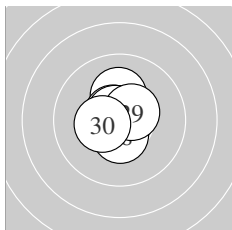

Serie 3:
 10.9 * 10.2 * 10.8 * 10.7 * 10.8 *
 10.7 * 10.9 * 10.5 * 10.5 * 10.4 *
 beste Teiler 7.0 (21.) 25.7 (27.) 40.3 (23.)
 Trefferlage 0.09 mm links, 0.24 mm hoch
 Streuwert 0.72, horizontal: 0.60, vertikal: 0.81

Unterschrift des Schützen

Ergebnis: **303.1** (288)
 Serien: 103.1 99.4 100.6
 Zähler: 18 12 0 0 0 0 0 0 0 0
 Innenzehner: 13
 weiteste: 429 (20), 408 (21), 396 (14)
 beste Teiler 35.6 (16.) 39.3 (5.) 53.0 (2.)
 Trefferlage 1.46 mm rechts, 0.49 mm tief
 Streuwert 1.31, horizontal: 1.42, vertikal: 1.18

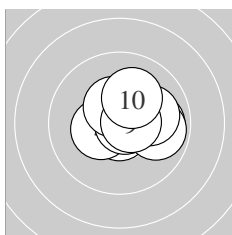
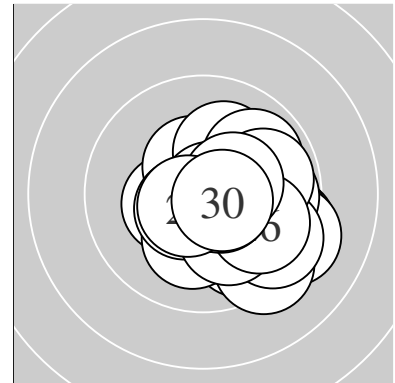

Serie 1:
 9.9 → 10.7 * 10.3 * 10.4 * 10.8 *
 9.9 → 10.4 * 10.0 → 10.6 * 10.1 ↗
 beste Teiler 39.3 (5.) 53.0 (2.) 84.3 (9.)
 Trefferlage 0.90 mm rechts, 0.32 mm hoch
 Streuwert 1.10, horizontal: 1.33, vertikal: 0.82

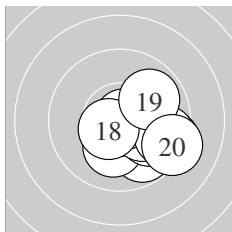

Serie 2:
 9.8 ↘ 10.1 ↓ 10.0 ↘ 9.4 ↘ 10.2 *
 10.8 * 9.5 ↘ 10.5 * 9.9 ↗ 9.2 ↘
 beste Teiler 35.6 (16.) 104.4 (18.) 186.9 (15.)
 Trefferlage 1.76 mm rechts, 0.98 mm tief
 Streuwert 1.41, horizontal: 1.65, vertikal: 1.13

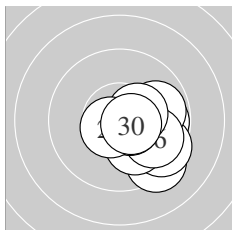

Serie 3:
 9.3 ↘ 9.8 → 9.5 ↘ 9.9 → 10.1 ↘
 9.8 ↘ 10.6 * 10.4 * 10.6 * 10.6 *
 beste Teiler 85.0 (27.) 86.0 (29.) 89.8 (30.)
 Trefferlage 1.72 mm rechts, 0.82 mm tief
 Streuwert 1.20, horizontal: 1.23, vertikal: 1.18

Unterschrift des Schützen

Ergebnis: **312.7** (298)
 Serien: 105.0 103.8 103.9
 Zähler: 28 2 0 0 0 0 0 0 0 0
 Innenzehner: 24
 weiteste: 261 (7), 260 (13), 250 (21)
 beste Teiler 10.0 (15.) 23.7 (4.) 33.5 (1.)
 Trefferlage 0.22 mm rechts, 0.06 mm tief
 Streuwert 1.10, horizontal: 1.16, vertikal: 1.02

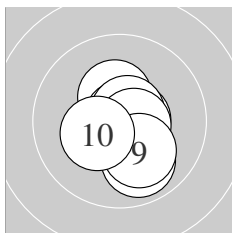
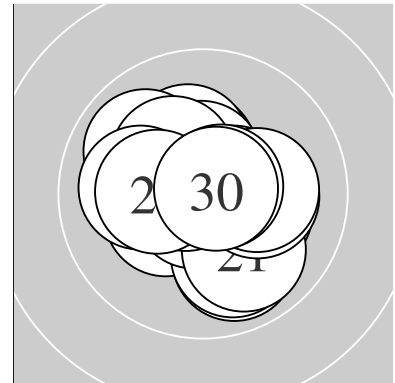

Serie 1:
 10.8 * 10.7 * 10.4 * 10.9 * 10.6 *
 10.7 * 9.9 ↘ 10.6 * 10.1 ↘ 10.3 *
 beste Teiler 23.7 (4.) 33.5 (1.) 52.0 (2.)
 Trefferlage 0.33 mm rechts, 0.32 mm tief
 Streuwert 0.95, horizontal: 0.78, vertikal: 1.10

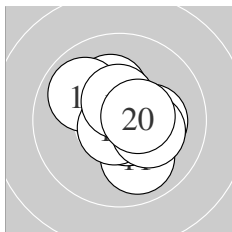

Serie 2:
 10.0 ↘ 10.2 * 9.9 ↖ 10.7 * 10.9 *
 10.2 * 10.7 * 10.2 * 10.5 * 10.5 *
 beste Teiler 10.0 (15.) 55.4 (17.) 69.3 (14.)
 Trefferlage 0.32 mm rechts, 0.08 mm hoch
 Streuwert 1.19, horizontal: 1.19, vertikal: 1.18

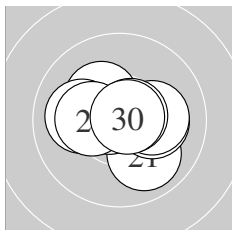

Serie 3:
 10.0 ↘ 10.7 * 10.7 * 10.2 * 10.2 *
 10.3 * 10.7 * 10.0 ← 10.3 * 10.8 *
 beste Teiler 50.6 (30.) 61.8 (22.) 64.5 (23.)
 Trefferlage 0.03 mm rechts, 0.05 mm hoch
 Streuwert 1.21, horizontal: 1.51, vertikal: 0.82

Unterschrift des Schützen

Ergebnis: **306.7** (293)
 Serien: 101.7 103.3 101.7
 Zähler: 24 5 1 0 0 0 0 0 0 0
 Innenzehner: 20
 weiteste: 533 (21), 366 (3), 356 (9)
 beste Teiler 9.4 (8.) 26.1 (18.) 36.3 (19.)
 Trefferlage 0.79 mm rechts, 0.83 mm tief
 Streuwert 1.32, horizontal: 1.51, vertikal: 1.08

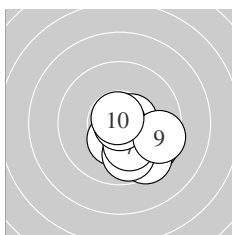
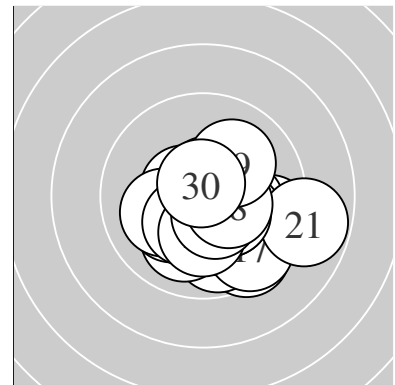

Serie 1:
 10.4 * 9.6 ↘ 9.5 ↘ 9.8 ↓ 10.4 *
 10.6 * 10.2 * 10.9 * 9.5 → 10.8 *
 beste Teiler 9.4 (8.) 45.6 (10.) 100.1 (6.)
 Trefferlage 1.15 mm rechts, 1.16 mm tief
 Streuwert 1.24, horizontal: 1.28, vertikal: 1.18

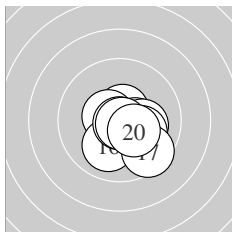

Serie 2:
 10.6 * 10.4 * 10.2 * 10.1 ↘ 10.5 *
 10.0 ↓ 9.5 ↘ 10.8 * 10.8 * 10.4 *
 beste Teiler 26.1 (18.) 36.3 (19.) 83.8 (11.)
 Trefferlage 0.71 mm rechts, 0.68 mm tief
 Streuwert 1.12, horizontal: 1.19, vertikal: 1.04

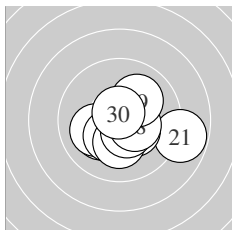

Serie 3:
 8.8 → 10.2 * 10.1 ← 10.3 * 10.4 *
 10.2 * 10.5 * 10.4 * 10.1 ↗ 10.7 *
 beste Teiler 64.7 (30.) 115.1 (27.) 136.6 (28.)
 Trefferlage 0.52 mm rechts, 0.65 mm tief
 Streuwert 1.61, horizontal: 2.03, vertikal: 1.05

Unterschrift des Schützen

Ergebnis: **311.4** (296)
 Serien: 104.8 104.6 102.0
 Zähler: 26 4 0 0 0 0 0 0 0 0
 Innenzehner: 22
 weiteste: 298 (24), 298 (27), 294 (4)
 beste Teiler 29.1 (22.) 31.1 (18.) 31.3 (13.)
 Trefferlage 0.62 mm rechts, 0.37 mm hoch
 Streuwert 1.07, horizontal: 1.00, vertikal: 1.14

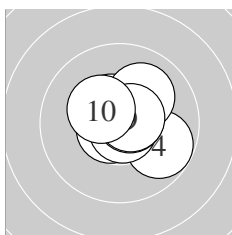
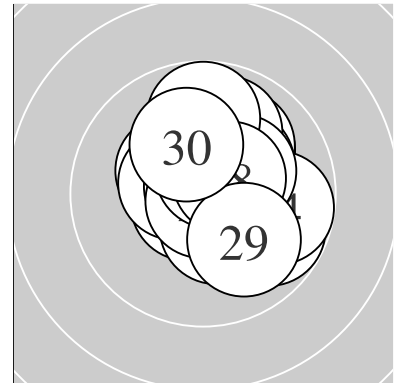

Serie 1:
 10.5 * 10.8 * 10.5 * 9.8 ↘ 10.7 *
 10.8 * 10.1 ↗ 10.7 * 10.6 * 10.3 *
 beste Teiler 43.4 (6.) 46.6 (2.) 72.4 (5.)
 Trefferlage 0.38 mm rechts, 0.23 mm hoch
 Streuwert 1.02, horizontal: 1.13, vertikal: 0.88

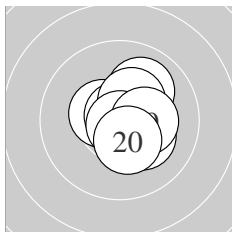

Serie 2:
 10.5 * 10.5 * 10.8 * 10.7 * 10.0 ↗
 10.4 * 10.2 * 10.8 * 10.3 * 10.4 *
 beste Teiler 31.1 (18.) 31.3 (13.) 56.6 (14.)
 Trefferlage 0.60 mm rechts, 0.06 mm hoch
 Streuwert 0.91, horizontal: 0.85, vertikal: 0.97

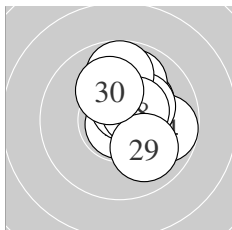

Serie 3:
 10.2 * 10.8 * 10.6 * 9.8 → 9.9 ↗
 10.3 * 9.8 ↑ 10.5 * 10.0 ↘ 10.1 ↖
 beste Teiler 29.1 (22.) 94.7 (23.) 120.2 (28.)
 Trefferlage 0.89 mm rechts, 0.82 mm hoch
 Streuwert 1.25, horizontal: 1.03, vertikal: 1.44

Unterschrift des Schützen

Ergebnis: **304.7** (295)
 Serien: 101.7 101.4 101.6
 Zähler: 25 5 0 0 0 0 0 0 0 0
 Innenzehner: 17
 weiteste: 437 (30), 402 (6), 331 (8)
 beste Teiler 77.8 (15.) 86.5 (29.) 92.1 (22.)
 Trefferlage 0.10 mm rechts, 0.08 mm hoch
 Streuwert 1.55, horizontal: 1.81, vertikal: 1.23

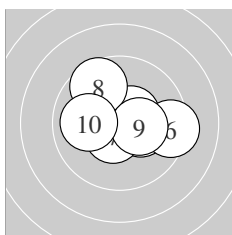
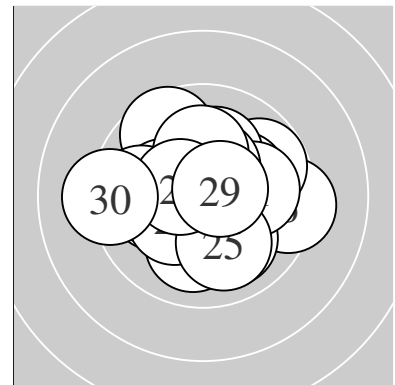

Serie 1:
 10.4 * 10.3 * 10.3 * 10.5 * 10.5 *
 9.3 → 10.5 * 9.6 ↘ 10.3 * 10.0 ←
 beste Teiler 102.5 (7.) 111.4 (4.) 113.5 (5.)
 Trefferlage 0.54 mm rechts, 0.07 mm hoch
 Streuwert 1.56, horizontal: 1.93, vertikal: 1.06

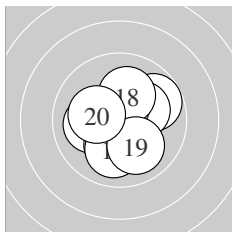

Serie 2:
 10.1 ← 10.1 ↓ 10.0 ↓ 9.8 ↗ 10.6 *
 10.3 * 10.2 * 10.1 ↑ 10.0 ↘ 10.2 *
 beste Teiler 77.8 (15.) 156.3 (16.) 184.3 (20.)
 Trefferlage 0.29 mm rechts, 0.04 mm tief
 Streuwert 1.52, horizontal: 1.53, vertikal: 1.52

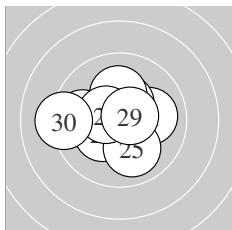

Serie 3:
 10.0 → 10.6 * 9.8 ← 10.3 * 10.0 ↓
 10.4 * 10.2 * 10.5 * 10.6 * 9.2 ←
 beste Teiler 86.5 (29.) 92.1 (22.) 114.9 (28.)
 Trefferlage 0.53 mm links, 0.21 mm hoch
 Streuwert 1.61, horizontal: 1.96, vertikal: 1.17

Unterschrift des Schützen

Ergebnis: **297.6** (285)
 Serien: 96.6 102.1 98.9
 Zähler: 17 11 2 0 0 0 0 0 0 0
 Innenzehner: 13
 weiteste: 547 (29), 537 (6), 428 (9)
 beste Teiler 47.3 (27.) 82.4 (28.) 89.8 (20.)
 Trefferlage 0.39 mm rechts, 0.27 mm hoch
 Streuwert 2.08, horizontal: 2.24, vertikal: 1.90

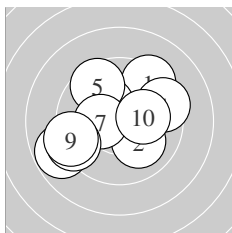
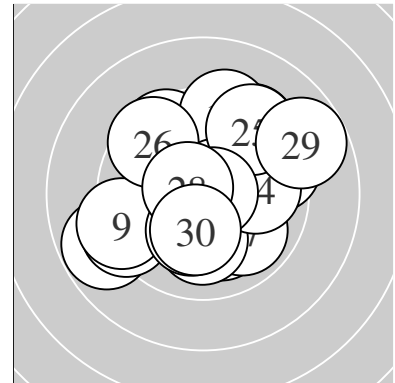

Serie 1:
 9.4 ↗ 10.1 ↘ 10.3 * 9.4 → 9.6 ↖
 8.8 ↙ 10.3 * 9.3 ↖ 9.2 ↖ 10.2 *
 beste Teiler 155.0 (7.) 173.2 (3.) 197.3 (10.)
 Trefferlage 0.75 mm links, 0.17 mm hoch
 Streuwert 2.54, horizontal: 2.97, vertikal: 2.02

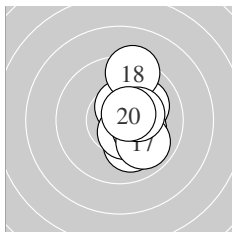

Serie 2:
 10.6 * 10.5 * 10.1 ↘ 10.1 ↗ 10.5 *
 10.2 * 9.9 ↘ 9.3 ↑ 10.3 * 10.6 *
 beste Teiler 89.8 (20.) 95.2 (11.) 107.1 (15.)
 Trefferlage 1.07 mm rechts, 0.08 mm hoch
 Streuwert 1.32, horizontal: 0.62, vertikal: 1.76

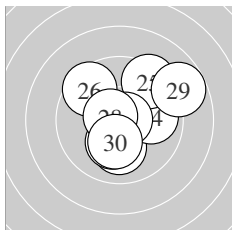

Serie 3:
 10.1 ↓ 10.2 * 9.4 ↗ 9.9 → 9.4 ↗
 9.5 ↘ 10.8 * 10.6 * 8.8 → 10.2 *
 beste Teiler 47.3 (27.) 82.4 (28.) 182.0 (30.)
 Trefferlage 0.87 mm rechts, 0.57 mm hoch
 Streuwert 2.13, horizontal: 2.19, vertikal: 2.07

Unterschrift des Schützen

Ergebnis: **305.4** (290)
 Serien: 101.9 100.9 102.6
 Zähler: 21 8 1 0 0 0 0 0 0 0
 Innenzehner: 17
 weiteste: 532 (4), 444 (12), 389 (17)
 beste Teiler 11.4 (19.) 24.1 (5.) 71.4 (29.)
 Trefferlage 1.23 mm links, 0.61 mm hoch
 Streuwert 1.32, horizontal: 1.61, vertikal: 0.95

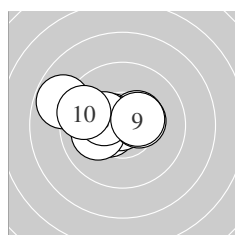
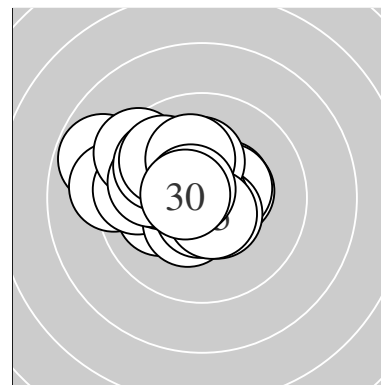

Serie 1:
 10.5 * 10.5 * 10.4 * 8.8 ↖ 10.9 *
 10.1 ← 10.4 * 10.3 * 10.4 * 9.6 ↖
 beste Teiler 24.1 (5.) 104.5 (2.) 122.4 (1.)
 Trefferlage 1.03 mm links, 0.44 mm hoch
 Streuwert 1.54, horizontal: 2.06, vertikal: 0.73

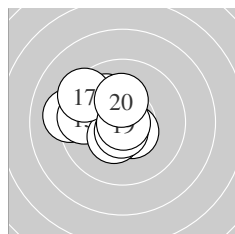

Serie 2:
 10.5 * 9.2 ← 10.1 ↘ 9.8 ↖ 9.7 ←
 10.4 * 9.4 ↘ 10.7 * 10.9 * 10.2 *
 beste Teiler 11.4 (19.) 75.8 (18.) 110.3 (11.)
 Trefferlage 1.51 mm links, 0.49 mm hoch
 Streuwert 1.51, horizontal: 1.77, vertikal: 1.21

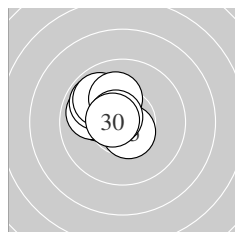

Serie 3:
 10.2 * 10.6 * 10.1 ↖ 9.9 ↖ 10.6 *
 9.9 ↘ 9.9 ↘ 10.1 ↗ 10.7 * 10.6 *
 beste Teiler 71.4 (29.) 85.7 (30.) 91.9 (22.)
 Trefferlage 1.14 mm links, 0.89 mm hoch
 Streuwert 0.91, horizontal: 0.94, vertikal: 0.87

Unterschrift des Schützen

Meyton Elektronik

Ergebnis: **310.1** (296)
 Serien: 102.5 104.5 103.1
 Zähler: 26 4 0 0 0 0 0 0 0 0
 Innenzehner: 21
 weiteste: 397 (28), 286 (10), 262 (5)
 beste Teiler 5.0 (17.) 39.6 (19.) 47.0 (15.)
 Trefferlage 0.12 mm rechts, 0.12 mm hoch
 Streuwert 1.26, horizontal: 1.36, vertikal: 1.16

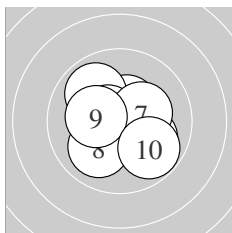
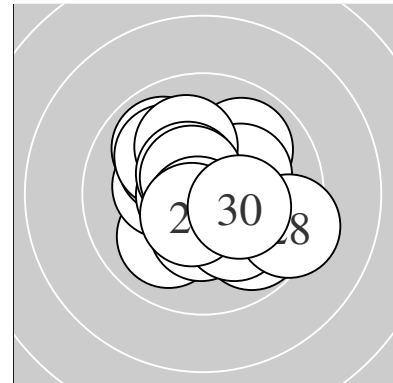

Serie 1:
 10.4 * 10.5 * 10.0 ↘ 10.7 * 9.9 ↖
 10.6 * 10.3 * 10.0 ↗ 10.3 * 9.8 ↘
 beste Teiler 62.3 (4.) 93.1 (6.) 122.1 (2.)
 Trefferlage 0.09 mm links, 0.05 mm tief
 Streuwert 1.42, horizontal: 1.54, vertikal: 1.30

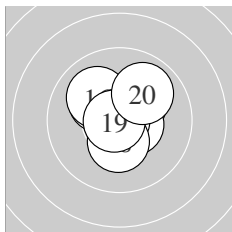

Serie 2:
 10.3 * 10.7 * 10.6 * 10.2 * 10.8 *
 10.0 ↘ 10.9 * 10.3 * 10.8 * 9.9 ↗
 beste Teiler 5.0 (17.) 39.6 (19.) 47.0 (15.)
 Trefferlage 0.01 mm links, 0.50 mm hoch
 Streuwert 1.05, horizontal: 1.05, vertikal: 1.04

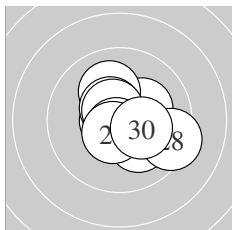

Serie 3:
 10.2 * 10.1 ↖ 10.7 * 10.5 * 10.6 *
 10.1 ↘ 10.7 * 9.4 ↗ 10.5 * 10.3 *
 beste Teiler 66.4 (27.) 67.1 (23.) 87.6 (25.)
 Trefferlage 0.49 mm rechts, 0.06 mm tief
 Streuwert 1.34, horizontal: 1.50, vertikal: 1.15

Unterschrift des Schützen

Ergebnis: **305.2** (292)
 Serien: 101.7 102.8 100.7
 Zähler: 22 8 0 0 0 0 0 0 0 0
 Innenzehner: 16
 weiteste: 384 (23), 381 (22), 352 (3)
 beste Teiler 16.2 (20.) 19.3 (7.) 31.0 (28.)
 Trefferlage 0.18 mm rechts, 0.04 mm tief
 Streuwert 1.54, horizontal: 1.90, vertikal: 1.08

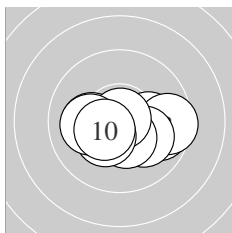
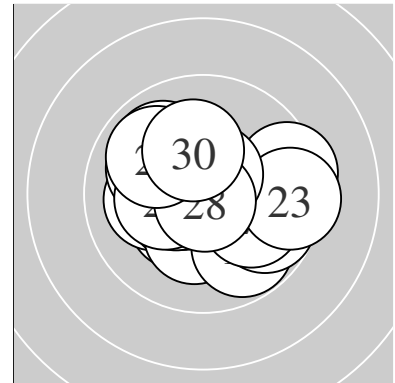

Serie 1:
 9.8 → 10.1 → 9.5 → 10.1 ↘ 10.4 *
 10.1 ← 10.9 * 10.3 * 10.1 ← 10.4 *
 beste Teiler 19.3 (7.) 127.6 (10.) 131.4 (5.)
 Trefferlage 0.44 mm rechts, 0.52 mm tief
 Streuwert 1.49, horizontal: 2.04, vertikal: 0.50

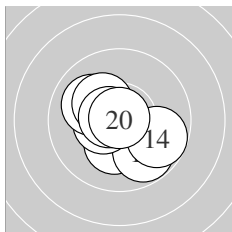

Serie 2:
 10.5 * 10.2 * 9.8 ↘ 9.8 ↘ 10.5 *
 10.3 * 10.0 ↖ 10.2 * 10.6 * 10.9 *
 beste Teiler 16.2 (20.) 81.0 (19.) 117.3 (11.)
 Trefferlage 0.18 mm links, 0.28 mm tief
 Streuwert 1.37, horizontal: 1.49, vertikal: 1.23

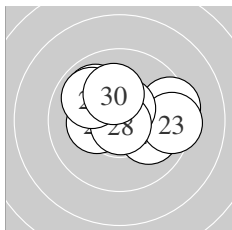

Serie 3:
 10.0 ↘ 9.4 → 9.4 → 10.6 * 10.2 *
 9.9 ↖ 10.3 * 10.8 * 9.9 ↖ 10.2 *
 beste Teiler 31.0 (28.) 94.8 (24.) 168.3 (27.)
 Trefferlage 0.28 mm rechts, 0.68 mm hoch
 Streuwert 1.74, horizontal: 2.22, vertikal: 1.04

Unterschrift des Schützen

Ergebnis: **309.1** (296)
 Serien: 102.9 102.9 103.3
 Zähler: 26 4 0 0 0 0 0 0 0 0
 Innenzehner: 23
 weiteste: 313 (29), 312 (13), 291 (17)
 beste Teiler 25.2 (22.) 41.1 (21.) 56.5 (1.)
 Trefferlage 0.35 mm links, 0.47 mm tief
 Streuwert 1.21, horizontal: 1.22, vertikal: 1.20

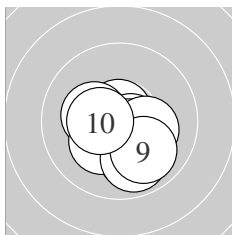
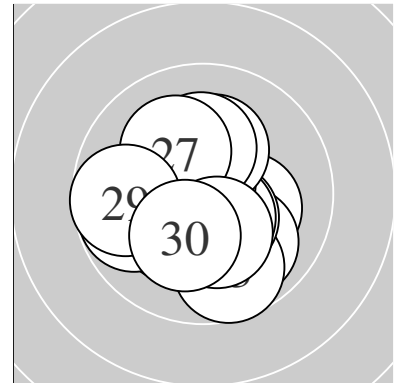

Serie 1:
 10.7 * 10.3 * 10.6 * 10.6 * 10.0 ↓
 10.2 * 10.2 * 9.9 ↓ 10.0 ↓ 10.4 *
 beste Teiler 56.5 (1.) 84.1 (3.) 97.3 (4.)
 Trefferlage 0.21 mm rechts, 0.88 mm tief
 Streuwert 1.16, horizontal: 1.23, vertikal: 1.10

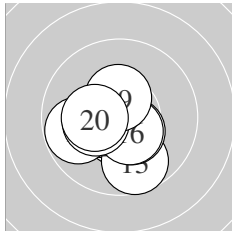

Serie 2:
 10.5 * 10.4 * 9.7 ↓ 10.5 * 10.5 *
 10.5 * 9.8 ← 10.3 * 10.4 * 10.3 *
 beste Teiler 101.8 (11.) 116.3 (14.) 116.8 (16.)
 Trefferlage 0.61 mm links, 0.66 mm tief
 Streuwert 1.16, horizontal: 1.26, vertikal: 1.05

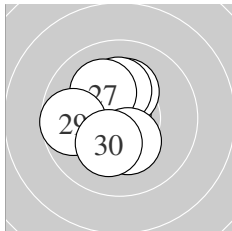

Serie 3:
 10.8 * 10.9 * 10.6 * 10.3 * 10.2 *
 10.2 * 10.1 ↘ 10.3 * 9.7 ← 10.2 *
 beste Teiler 25.2 (22.) 41.1 (21.) 77.8 (23.)
 Trefferlage 0.67 mm links, 0.12 mm hoch
 Streuwert 1.20, horizontal: 1.08, vertikal: 1.30

Unterschrift des Schützen

Ergebnis: **309.1** (294)
 Serien: 101.5 102.3 105.3
 Zähler: 24 6 0 0 0 0 0 0 0 0
 Innenzehner: 23
 weiteste: 451 (1), 380 (16), 322 (6)
 beste Teiler 25.4 (19.) 41.5 (25.) 50.0 (10.)
 Trefferlage 0.12 mm rechts, 0.45 mm hoch
 Streuwert 1.35, horizontal: 1.09, vertikal: 1.57

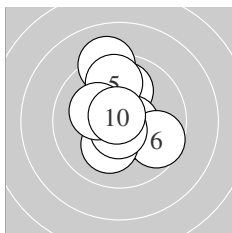
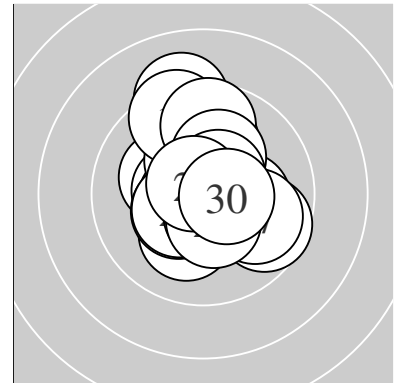

Serie 1:
 9.1 ↑ 10.5 * 10.0 ↑ 10.6 * 9.7 ↑
 9.7 ↘ 10.2 * 10.7 * 10.2 * 10.8 *
 beste Teiler 50.0 (10.) 70.5 (8.) 89.2 (4.)
 Trefferlage 0.07 mm rechts, 0.60 mm hoch
 Streuwert 1.71, horizontal: 1.28, vertikal: 2.05

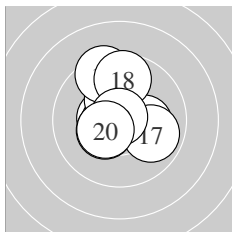

Serie 2:
 10.5 * 10.6 * 10.4 * 10.3 * 10.2 *
 9.4 ↑ 9.9 ↘ 9.7 ↑ 10.9 * 10.4 *
 beste Teiler 25.4 (19.) 82.7 (12.) 113.1 (11.)
 Trefferlage 0.14 mm links, 0.57 mm hoch
 Streuwert 1.50, horizontal: 1.32, vertikal: 1.66

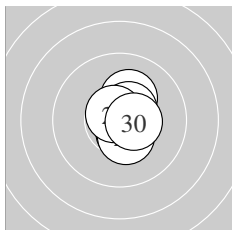

Serie 3:
 10.4 * 10.7 * 10.5 * 10.6 * 10.8 *
 10.2 * 10.4 * 10.5 * 10.7 * 10.5 *
 beste Teiler 41.5 (25.) 55.4 (22.) 64.4 (29.)
 Trefferlage 0.45 mm rechts, 0.18 mm hoch
 Streuwert 0.73, horizontal: 0.49, vertikal: 0.91

Unterschrift des Schützen

Ergebnis: **288.1** (276)
 Serien: 95.8 96.4 95.9
 Zähler: 11 15 3 1 0 0 0 0 0 0
 Innenzehner: 5
 weiteste: 755 (22), 600 (16), 514 (10)
 beste Teiler 85.4 (20.) 128.4 (21.) 161.9 (30.)
 Trefferlage 0.83 mm links, 0.19 mm hoch
 Streuwert 2.58, horizontal: 2.74, vertikal: 2.42

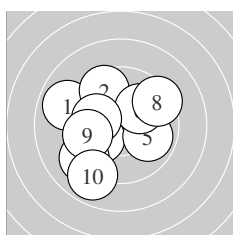
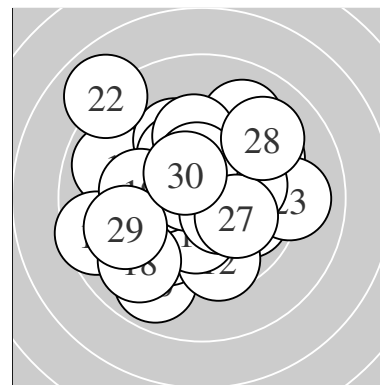

Serie 1:
 8.9 ↖ 9.6 ↗ 10.1 ↙ 9.2 ↘ 9.9 ↘
 10.0 ↗ 10.1 ↖ 9.4 ↗ 9.7 ↖ 8.9 ↘
 beste Teiler 220.8 (3.) 224.3 (7.) 226.1 (6.)
 Trefferlage 1.15 mm links, 0.13 mm tief
 Streuwert 2.55, horizontal: 2.70, vertikal: 2.40

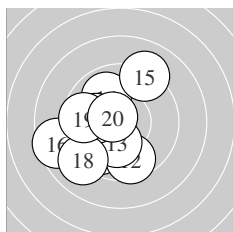

Serie 2:
 9.7 ↘ 9.6 ↓ 10.2 * 9.9 ↖ 9.1 ↗
 8.6 ↖ 10.1 ↖ 9.0 ↘ 9.6 ↖ 10.6 *
 beste Teiler 85.4 (20.) 185.9 (13.) 223.6 (17.)
 Trefferlage 1.57 mm links, 0.53 mm tief
 Streuwert 2.37, horizontal: 2.27, vertikal: 2.48

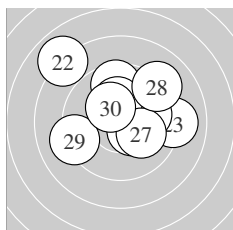

Serie 3:
 10.4 * 7.9 ↖ 9.1 → 9.6 ↑ 10.0 →
 10.2 * 10.1 ↘ 9.1 ↗ 9.2 ↖ 10.3 *
 beste Teiler 128.4 (21.) 161.9 (30.) 185.1 (26.)
 Trefferlage 0.22 mm rechts, 1.25 mm hoch
 Streuwert 2.72, horizontal: 3.12, vertikal: 2.25

Unterschrift des Schützen

Ergebnis: **306.2** (294)
 Serien: 101.7 101.8 102.7
 Zähler: 24 6 0 0 0 0 0 0 0 0
 Innenzehner: 17
 weiteste: 329 (27), 311 (10), 282 (18)
 beste Teiler 63.7 (4.) 70.0 (24.) 94.6 (22.)
 Trefferlage 0.07 mm links, 0.77 mm hoch
 Streuwert 1.33, horizontal: 1.36, vertikal: 1.29

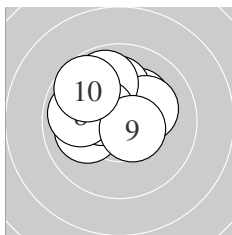
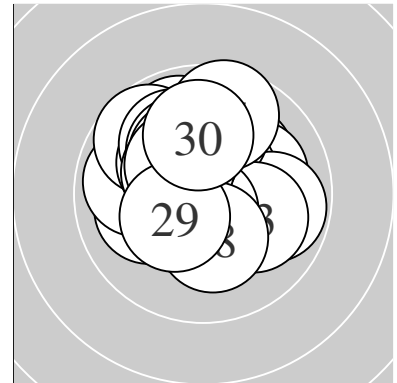

Serie 1:
 10.2 * 10.0 ← 10.1 ↑ 10.7 * 10.2 *
 9.9 ↗ 10.4 * 9.9 ← 10.6 * 9.7 ↘
 beste Teiler 63.7 (4.) 100.8 (9.) 133.2 (7.)
 Trefferlage 0.51 mm links, 0.96 mm hoch
 Streuwert 1.35, horizontal: 1.55, vertikal: 1.10

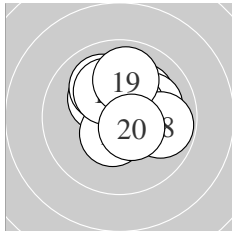

Serie 2:
 10.2 * 10.1 ↗ 10.5 * 10.1 → 10.0 ↘
 10.5 * 10.2 * 9.8 → 9.9 ↑ 10.5 *
 beste Teiler 106.4 (20.) 108.9 (16.) 119.6 (13.)
 Trefferlage 0.44 mm rechts, 0.81 mm hoch
 Streuwert 1.31, horizontal: 1.39, vertikal: 1.23

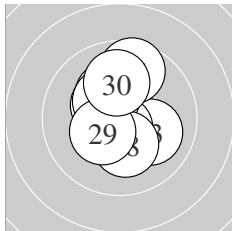

Serie 3:
 10.4 * 10.6 * 10.1 ↘ 10.7 * 10.3 *
 10.4 * 9.6 ↑ 10.2 * 10.4 * 10.0 ↑
 beste Teiler 70.0 (24.) 94.6 (22.) 140.0 (21.)
 Trefferlage 0.16 mm links, 0.54 mm hoch
 Streuwert 1.35, horizontal: 1.02, vertikal: 1.61

Unterschrift des Schützen

Ergebnis: **304.0** (290)
 Serien: 101.0 102.4 100.6
 Zähler: 20 10 0 0 0 0 0 0 0 0
 Innenzehner: 17
 weiteste: 371 (27), 368 (26), 333 (6)
 beste Teiler 57.5 (15.) 97.1 (13.) 122.1 (17.)
 Trefferlage 0.36 mm rechts, 0.06 mm tief
 Streuwert 1.57, horizontal: 1.88, vertikal: 1.18

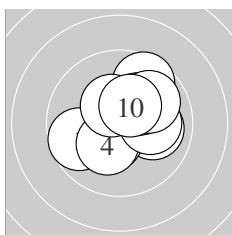
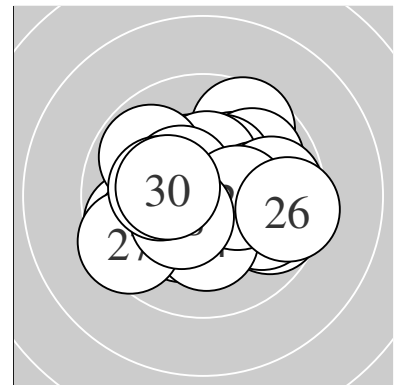

Serie 1:
 9.7 ← 10.0 → 10.4 * 10.3 * 10.1 →
 9.6 ↗ 10.4 * 10.2 * 9.9 ↘ 10.4 *
 beste Teiler 130.1 (3.) 138.2 (7.) 147.1 (10.)
 Trefferlage 0.55 mm rechts, 0.41 mm hoch
 Streuwert 1.59, horizontal: 1.73, vertikal: 1.45

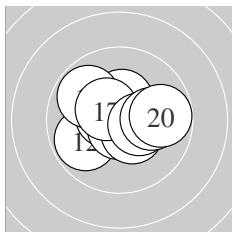

Serie 2:
 10.4 * 9.8 ← 10.6 * 9.8 ↘ 10.7 *
 10.4 * 10.5 * 10.4 * 10.0 → 9.8 →
 beste Teiler 57.5 (15.) 97.1 (13.) 122.1 (17.)
 Trefferlage 0.10 mm rechts, 0.14 mm hoch
 Streuwert 1.45, horizontal: 1.80, vertikal: 0.97

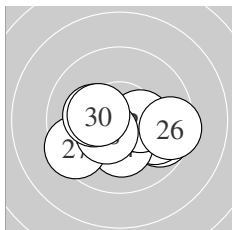

Serie 3:
 10.5 * 9.7 → 9.9 → 10.2 * 10.4 *
 9.5 → 9.5 ← 10.4 * 10.2 * 10.3 *
 beste Teiler 125.0 (21.) 128.7 (28.) 148.2 (25.)
 Trefferlage 0.42 mm rechts, 0.75 mm tief
 Streuwert 1.69, horizontal: 2.26, vertikal: 0.80

Unterschrift des Schützen

Ergebnis: **300.7** (289)
 Serien: 99.5 100.1 101.1
 Zähler: 19 11 0 0 0 0 0 0 0 0
 Innenzehner: 11
 weiteste: 395 (8), 378 (9), 371 (18)
 beste Teiler 73.0 (30.) 73.7 (11.) 87.7 (17.)
 Trefferlage 0.81 mm links, 0.05 mm tief
 Streuwert 1.68, horizontal: 1.86, vertikal: 1.49

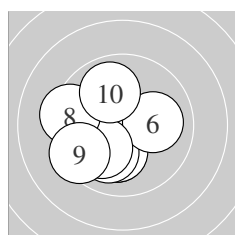
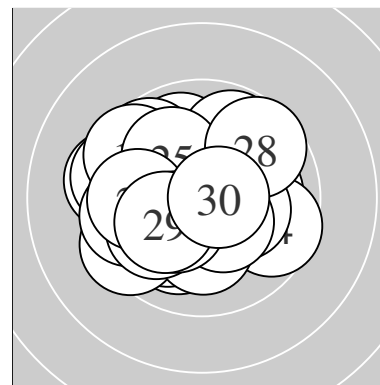

Serie 1:
 10.1 ↓ 10.2 * 10.0 ↙ 10.3 * 10.1 ←
 10.1 → 10.0 ↘ 9.4 ← 9.4 ↙ 9.9 ↗
 beste Teiler 167.2 (4.) 199.8 (2.) 201.6 (1.)
 Trefferlage 1.19 mm links, 0.49 mm tief
 Streuwert 1.67, horizontal: 1.68, vertikal: 1.67

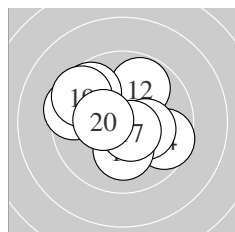

Serie 2:
 10.7 * 9.8 ↗ 9.7 ↘ 9.6 ↘ 10.2 *
 10.1 ↓ 10.6 * 9.5 ← 9.5 ↘ 10.4 *
 beste Teiler 73.7 (11.) 87.7 (17.) 143.8 (20.)
 Trefferlage 0.32 mm links, 0.38 mm hoch
 Streuwert 1.88, horizontal: 2.18, vertikal: 1.52

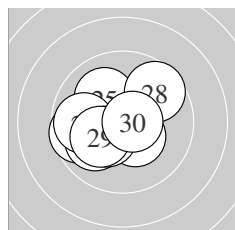

Serie 3:
 9.6 ← 10.4 * 10.0 ↙ 10.4 * 10.1 ↘
 9.8 ← 10.3 * 9.6 ↗ 10.2 * 10.7 *
 beste Teiler 73.0 (30.) 140.9 (22.) 141.1 (24.)
 Trefferlage 0.93 mm links, 0.05 mm tief
 Streuwert 1.54, horizontal: 1.76, vertikal: 1.27

Unterschrift des Schützen

Meyton Elektronik

Ergebnis: **307.2** (295)
 Serien: 102.4 101.8 103.0
 Zähler: 25 5 0 0 0 0 0 0 0 0
 Innenzehner: 19
 weiteste: 449 (16), 372 (28), 299 (5)
 beste Teiler 52.8 (14.) 54.4 (20.) 61.1 (23.)
 Trefferlage 0.48 mm links, 0.24 mm tief
 Streuwert 1.39, horizontal: 1.40, vertikal: 1.38

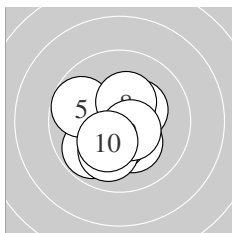
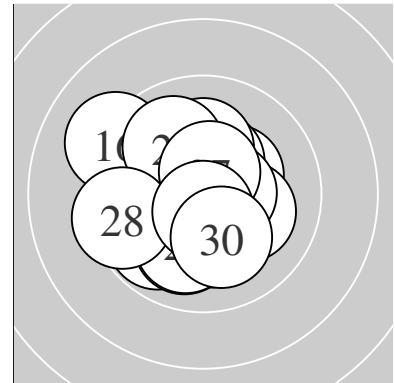

Serie 1:
 9.8 ↙ 10.2 * 10.7 * 10.3 * 9.8 ↘
 10.4 * 10.0 ↓ 10.4 * 10.5 * 10.3 *
 beste Teiler 63.9 (3.) 105.1 (9.) 137.3 (6.)
 Trefferlage 0.34 mm links, 0.54 mm tief
 Streuwert 1.35, horizontal: 1.33, vertikal: 1.37

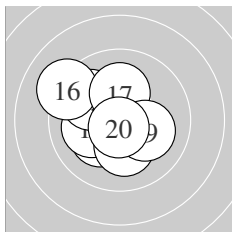

Serie 2:
 10.2 * 10.1 ← 10.5 * 10.7 * 9.9 ↘
 9.2 ↖ 10.2 * 10.2 * 10.1 → 10.7 *
 beste Teiler 52.8 (14.) 54.4 (20.) 117.9 (13.)
 Trefferlage 0.82 mm links, 0.22 mm hoch
 Streuwert 1.52, horizontal: 1.60, vertikal: 1.43

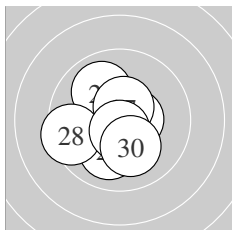

Serie 3:
 10.4 * 10.7 * 10.7 * 10.0 ↓ 10.5 *
 10.0 ↘ 10.5 * 9.5 ← 10.6 * 10.1 ↓
 beste Teiler 61.1 (23.) 68.2 (22.) 78.0 (29.)
 Trefferlage 0.29 mm links, 0.41 mm tief
 Streuwert 1.34, horizontal: 1.34, vertikal: 1.34

Unterschrift des Schützen

Ergebnis: **300.9** (290)
 Serien: 101.4 100.5 99.0
 Zähler: 21 8 1 0 0 0 0 0 0 0
 Innenzehner: 13
 weiteste: 613 (21), 417 (13), 399 (30)
 beste Teiler 64.3 (20.) 107.9 (9.) 113.0 (28.)
 Trefferlage 0.07 mm links, 0.04 mm hoch
 Streuwert 1.82, horizontal: 1.69, vertikal: 1.94

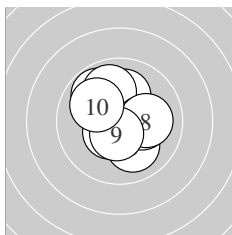
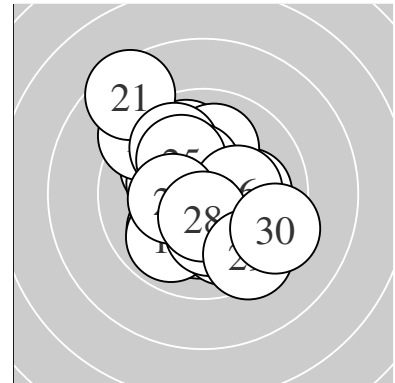

Serie 1:
 10.5 * 9.8 ↘ 10.3 * 10.1 ↑ 9.9 ↗
 10.0 ↘ 10.2 * 10.1 → 10.5 * 10.0 ↘
 beste Teiler 107.9 (9.) 123.1 (1.) 155.9 (3.)
 Trefferlage 0.11 mm rechts, 0.31 mm hoch
 Streuwert 1.53, horizontal: 1.47, vertikal: 1.59

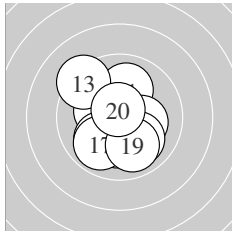

Serie 2:
 10.0 ↑ 10.3 * 9.3 ↘ 10.2 * 10.0 ↗
 10.2 * 9.9 ↙ 10.0 ↘ 9.9 ↘ 10.7 *
 beste Teiler 64.3 (20.) 166.3 (12.) 184.0 (16.)
 Trefferlage 0.31 mm links, 0.41 mm tief
 Streuwert 1.75, horizontal: 1.58, vertikal: 1.91

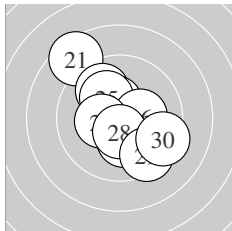

Serie 3:
 8.5 ↘ 10.2 * 9.9 ↘ 10.4 * 10.1 ↗
 10.3 * 10.3 * 10.5 * 9.4 ↘ 9.4 ↘
 beste Teiler 113.0 (28.) 133.6 (24.) 153.0 (27.)
 Trefferlage 0.01 mm links, 0.24 mm hoch
 Streuwert 2.24, horizontal: 2.11, vertikal: 2.37

Unterschrift des Schützen

Ergebnis: **306.6** (294)
 Serien: 100.5 102.8 103.3
 Zähler: 24 6 0 0 0 0 0 0 0 0
 Innenzehner: 19
 weiteste: 484 (15), 467 (7), 328 (21)
 beste Teiler 30.0 (12.) 68.0 (16.) 77.2 (14.)
 Trefferlage 0.04 mm links, 0.31 mm hoch
 Streuwert 1.49, horizontal: 1.55, vertikal: 1.42

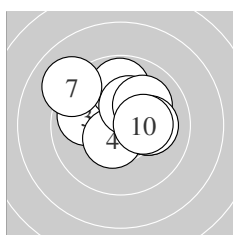
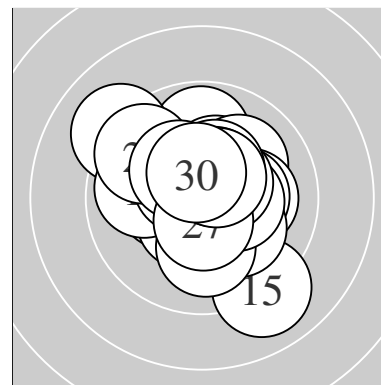

Serie 1:
 10.1 → 10.3 * 9.9 ← 10.5 * 9.8 ↑
 10.3 * 9.1 ↘ 10.1 ↗ 10.1 → 10.3 *
 beste Teiler 116.2 (4.) 159.1 (6.) 163.2 (2.)
 Trefferlage 0.20 mm rechts, 0.98 mm hoch
 Streuwert 1.66, horizontal: 1.97, vertikal: 1.26

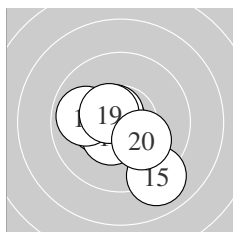

Serie 2:
 10.4 * 10.8 * 10.3 * 10.6 * 9.0 ↘
 10.7 * 10.5 * 9.9 ← 10.5 * 10.1 ↘
 beste Teiler 30.0 (12.) 68.0 (16.) 77.2 (14.)
 Trefferlage 0.40 mm links, 0.53 mm tief
 Streuwert 1.46, horizontal: 1.52, vertikal: 1.39

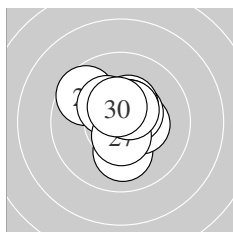

Serie 3:
 9.6 ↘ 10.1 ↓ 10.4 * 10.5 * 10.4 *
 10.3 * 10.5 * 10.5 * 10.5 * 10.5 *
 beste Teiler 103.1 (27.) 110.1 (28.) 112.6 (29.)
 Trefferlage 0.05 mm rechts, 0.48 mm hoch
 Streuwert 1.21, horizontal: 1.16, vertikal: 1.26

Unterschrift des Schützen

Ergebnis: **296.9** (283)
 Serien: 99.9 100.7 96.3
 Zähler: 16 11 3 0 0 0 0 0 0 0
 Innenzehner: 12
 weiteste: 637 (27), 539 (24), 528 (8)
 beste Teiler 46.1 (3.) 55.0 (28.) 89.8 (15.)
 Trefferlage 1.58 mm rechts, 0.74 mm tief
 Streuwert 1.75, horizontal: 1.91, vertikal: 1.56

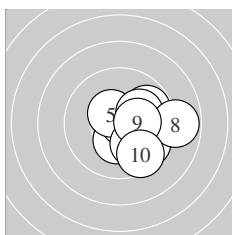
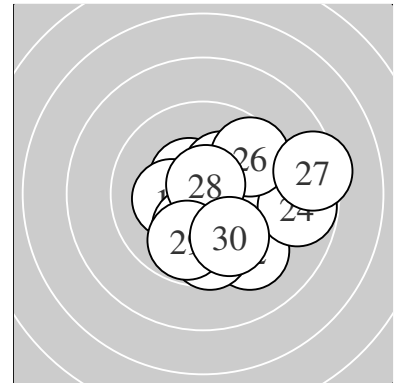

Serie 1:
 9.8 ↗ 10.3 * 10.8 * 9.7 ↘ 10.5 *
 10.1 ↗ 10.0 ↘ 8.8 → 10.3 * 9.6 ↘
 beste Teiler 46.1 (3.) 122.0 (5.) 162.2 (2.)
 Trefferlage 1.67 mm rechts, 0.49 mm tief
 Streuwert 1.59, horizontal: 1.71, vertikal: 1.47

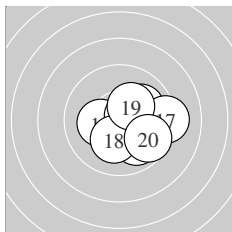

Serie 2:
 9.9 ↘ 10.2 * 10.2 * 10.4 * 10.6 *
 10.0 ↗ 9.2 → 10.2 * 10.3 * 9.7 ↘
 beste Teiler 89.8 (15.) 142.8 (14.) 169.1 (19.)
 Trefferlage 1.28 mm rechts, 0.48 mm tief
 Streuwert 1.46, horizontal: 1.67, vertikal: 1.21

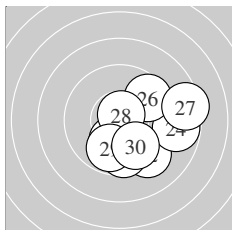

Serie 3:
 10.0 ↓ 9.3 ↘ 10.2 * 8.8 → 9.7 ↓
 9.6 ↗ 8.4 → 10.7 * 9.8 ↓ 9.8 ↘
 beste Teiler 55.0 (28.) 198.9 (23.) 249.5 (21.)
 Trefferlage 1.79 mm rechts, 1.25 mm tief
 Streuwert 2.20, horizontal: 2.44, vertikal: 1.94

Unterschrift des Schützen

Ergebnis: **288.4** (275)
 Serien: 97.5 95.2 95.7
 Zähler: 14 8 7 1 0 0 0 0 0 0
 Innenzehner: 9
 weiteste: 862 (5), 622 (30), 618 (11)
 beste Teiler 34.9 (6.) 37.7 (26.) 81.1 (22.)
 Trefferlage 0.01 mm rechts, 0.63 mm tief
 Streuwert 2.81, horizontal: 3.57, vertikal: 1.75

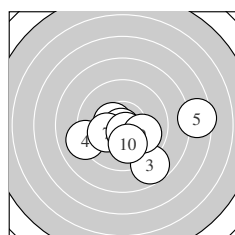
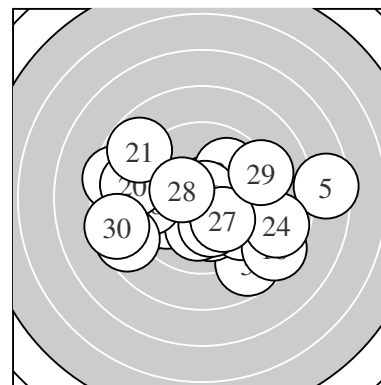

Serie 1:
 10.5 * 10.0 ↘ 8.7 ↘ 9.1 ← 7.5 →
 10.8 * 10.2 * 10.6 * 10.0 → 10.1 ↓
 beste Teiler 34.9 (6.) 84.1 (8.) 118.5 (1.)
 Trefferlage 0.89 mm rechts, 1.20 mm tief
 Streuwert 2.66, horizontal: 3.44, vertikal: 1.51

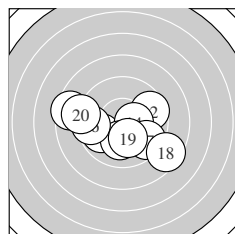

Serie 2:
 8.5 ← 9.6 → 9.8 ← 10.4 * 10.1 ↓
 9.5 ← 9.6 ↘ 8.5 ↘ 10.2 * 9.0 ←
 beste Teiler 130.0 (14.) 192.8 (19.) 212.4 (15.)
 Trefferlage 0.45 mm links, 0.75 mm tief
 Streuwert 2.85, horizontal: 3.68, vertikal: 1.65

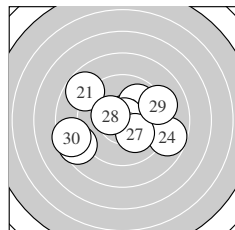

Serie 3:
 8.8 ↘ 10.6 * 9.9 ↗ 8.8 → 8.6 ←
 10.8 * 10.1 ↘ 10.4 * 9.2 → 8.5 ←
 beste Teiler 37.7 (26.) 81.1 (22.) 150.7 (28.)
 Trefferlage 0.38 mm links, 0.03 mm hoch
 Streuwert 3.03, horizontal: 3.79, vertikal: 2.01

Unterschrift des Schützen

Ergebnis: **285.3** (273)
 Serien: 96.7 90.7 97.9
 Zähler: 13 10 6 0 0 1 0 0 0 0
 Innenzehner: 12
 weiteste: 1283 (19), 719 (9), 704 (21)
 beste Teiler 105.7 (15.) 111.2 (17.) 112.0 (7.)
 Trefferlage 0.31 mm rechts, 0.48 mm hoch
 Streuwert 3.14, horizontal: 3.94, vertikal: 2.05

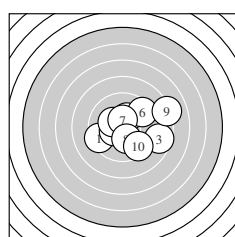
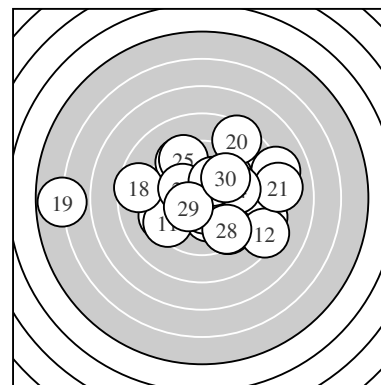

Serie 1:
 9.4 ↙ 10.4 * 8.6 ↘ 10.3 * 10.3 *
 9.4 ↗ 10.5 * 10.2 * 8.1 → 9.5 ↘
 beste Teiler 112.0 (7.) 144.5 (2.) 159.9 (4.)
 Trefferlage 1.25 mm rechts, 0.05 mm tief
 Streuwert 2.65, horizontal: 3.22, vertikal: 1.91

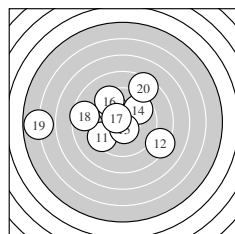

Serie 2:
 9.4 ↙ 8.3 ↘ 10.0 ↖ 9.7 ↗ 10.5 *
 9.4 ↘ 10.5 * 8.6 ← 5.8 ← 8.5 ↗
 beste Teiler 105.7 (15.) 111.2 (17.) 242.0 (13.)
 Trefferlage 1.46 mm links, 0.71 mm hoch
 Streuwert 4.09, horizontal: 5.19, vertikal: 2.56

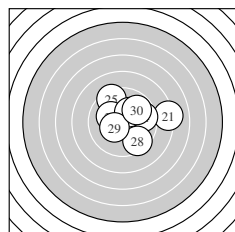

Serie 3:
 8.1 → 10.2 * 10.4 * 9.7 → 9.4 ↘
 10.2 * 10.2 * 9.5 ↘ 10.4 * 9.8 ↗
 beste Teiler 143.5 (23.) 148.9 (29.) 182.4 (27.)
 Trefferlage 1.14 mm rechts, 0.78 mm hoch
 Streuwert 2.27, horizontal: 2.74, vertikal: 1.67

Unterschrift des Schützen

Ergebnis: **306.5** (294)
 Serien: 102.2 101.1 103.2
 Zähler: 24 6 0 0 0 0 0 0 0 0
 Innenzehner: 17
 weiteste: 343 (27), 337 (4), 320 (12)
 beste Teiler 3.1 (25.) 15.5 (29.) 86.3 (2.)
 Trefferlage 0.46 mm links, 0.72 mm tief
 Streuwert 1.32, horizontal: 1.52, vertikal: 1.10

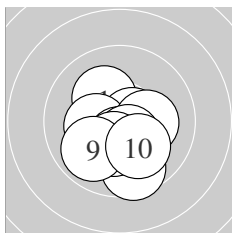
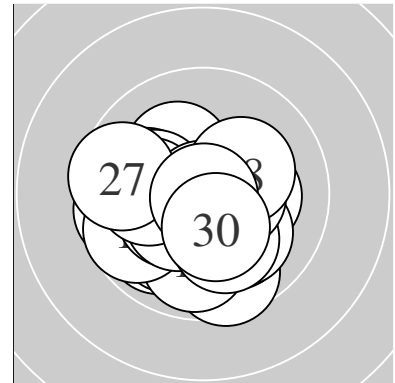

Serie 1:
 10.2 * 10.6 * 10.3 * 9.6 ↘ 10.5 *
 10.2 * 10.5 * 10.3 * 9.9 ↗ 10.1 ↘
 beste Teiler 86.3 (2.) 124.0 (5.) 124.8 (7.)
 Trefferlage 0.06 mm rechts, 0.95 mm tief
 Streuwert 1.30, horizontal: 1.26, vertikal: 1.33

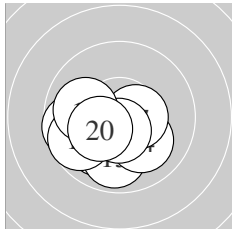

Serie 2:
 10.0 ↗ 9.7 ← 9.9 ↓ 10.1 ↘ 10.3 *
 9.7 ↗ 10.5 * 10.6 * 10.0 ← 10.3 *
 beste Teiler 94.1 (18.) 112.0 (17.) 154.9 (15.)
 Trefferlage 1.02 mm links, 0.99 mm tief
 Streuwert 1.28, horizontal: 1.56, vertikal: 0.93

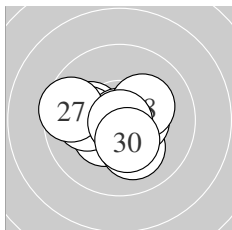

Serie 3:
 10.1 ← 10.4 * 10.1 ↘ 10.1 ← 10.9 *
 10.5 * 9.6 ← 10.2 * 10.9 * 10.4 *
 beste Teiler 3.1 (25.) 15.5 (29.) 121.1 (26.)
 Trefferlage 0.43 mm links, 0.22 mm tief
 Streuwert 1.34, horizontal: 1.65, vertikal: 0.91

Unterschrift des Schützen

Ergebnis: **306.1** (290)
 Serien: 104.4 103.5 98.2
 Zähler: 21 8 1 0 0 0 0 0 0 0
 Innenzehner: 16
 weiteste: 562 (27), 386 (28), 337 (23)
 beste Teiler 25.5 (16.) 38.2 (3.) 43.8 (18.)
 Trefferlage 0.14 mm rechts, 0.20 mm tief
 Streuwert 1.61, horizontal: 1.74, vertikal: 1.45

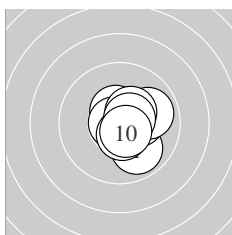
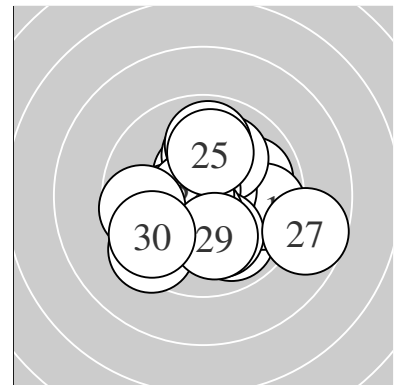

Serie 1:
 9.9 ↘ 10.3 * 10.8 * 10.5 * 9.9 →
 10.8 * 10.6 * 10.4 * 10.6 * 10.6 *
 beste Teiler 38.2 (3.) 46.0 (6.) 88.6 (10.)
 Trefferlage 0.70 mm rechts, 0.01 mm tief
 Streuwert 0.98, horizontal: 0.95, vertikal: 1.01

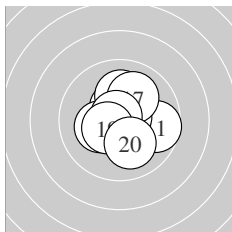

Serie 2:
 9.7 → 10.5 * 10.1 ↑ 10.7 * 10.2 *
 10.9 * 10.0 ↗ 10.8 * 10.5 * 10.1 ↘
 beste Teiler 25.5 (16.) 43.8 (18.) 60.8 (14.)
 Trefferlage 0.22 mm rechts, 0.17 mm hoch
 Streuwert 1.29, horizontal: 1.32, vertikal: 1.26

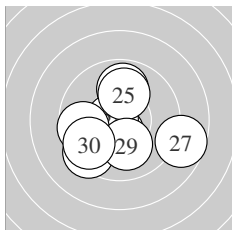

Serie 3:
 9.9 ↑ 10.5 * 9.6 ↙ 10.7 * 10.0 ↑
 9.7 ← 8.7 ↘ 9.4 ↙ 10.1 ↓ 9.6 ↙
 beste Teiler 63.0 (24.) 106.9 (22.) 217.4 (29.)
 Trefferlage 0.51 mm links, 0.78 mm tief
 Streuwert 2.23, horizontal: 2.51, vertikal: 1.91

Unterschrift des Schützen

Ergebnis: **289.6** (279)
 Serien: 95.8 96.6 97.2
 Zähler: 13 13 4 0 0 0 0 0 0 0
 Innenzehner: 7
 weiteste: 624 (22), 621 (15), 561 (16)
 beste Teiler 111.7 (21.) 129.1 (11.) 142.4 (18.)
 Trefferlage 0.48 mm links, 0.99 mm tief
 Streuwert 2.44, horizontal: 2.69, vertikal: 2.16

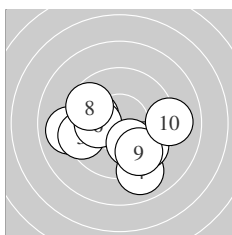
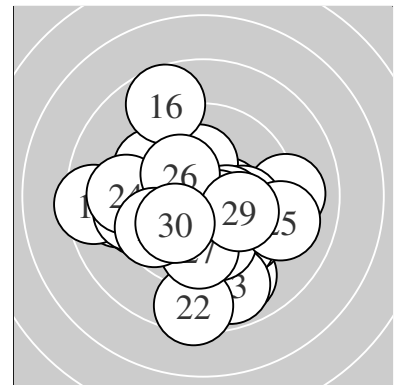

Serie 1:
 9.0 ← 10.0 ← 9.4 ← 9.0 ↓ 9.7 ↘
 10.1 ← 10.1 ↓ 9.7 ↖ 9.7 ↓ 9.1 →
 beste Teiler 204.1 (6.) 208.8 (7.) 243.0 (2.)
 Trefferlage 0.37 mm links, 1.06 mm tief
 Streuwert 2.54, horizontal: 3.12, vertikal: 1.79

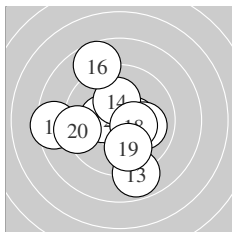

Serie 2:
 10.4 * 10.3 * 8.9 ↓ 10.2 * 8.5 ←
 8.7 ↗ 10.0 → 10.4 * 9.9 ↓ 9.3 ←
 beste Teiler 129.1 (11.) 142.4 (18.) 157.4 (12.)
 Trefferlage 0.69 mm links, 0.29 mm tief
 Streuwert 2.70, horizontal: 2.75, vertikal: 2.64

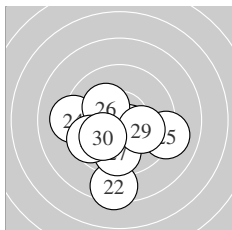

Serie 3:
 10.5 * 8.5 ↓ 10.2 * 9.2 ← 9.1 →
 10.2 * 9.7 ↓ 9.6 ↙ 10.1 → 10.1 ↙
 beste Teiler 111.7 (21.) 178.9 (26.) 185.1 (23.)
 Trefferlage 0.37 mm links, 1.61 mm tief
 Streuwert 2.23, horizontal: 2.45, vertikal: 1.99

Unterschrift des Schützen

Ergebnis: **284.9** (270)
 Serien: 92.7 97.7 94.5 0.0
 Zähler: 7 16 7 0 0 0 0 0 0 0
 Innenzehner: 3
 weiteste: 640 (24), 593 (1), 586 (8)
 beste Teiler 48.0 (20.) 126.5 (23.) 152.5 (13.)
 Trefferlage 0.22 mm links, 1.18 mm hoch
 Streuwert 2.70, horizontal: 2.95, vertikal: 2.41

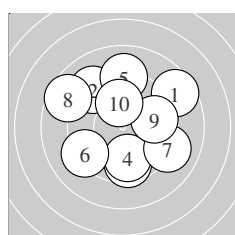
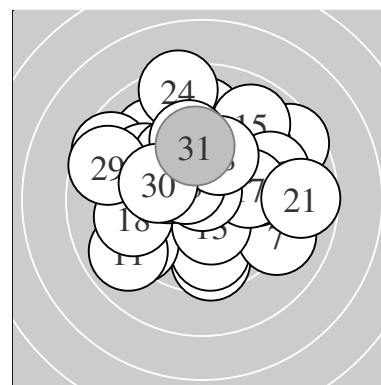

Serie 1:
 8.6 ↗ 9.1 ↘ 9.5 ↓ 9.8 ↓ 9.1 ↑
 9.2 ↙ 9.1 ↘ 8.6 ↖ 9.7 → 10.0 ↑
 beste Teiler 231.3 (10.) 295.7 (4.) 309.9 (9.)
 Trefferlage 0.14 mm rechts, 0.63 mm hoch
 Streuwert 3.21, horizontal: 3.33, vertikal: 3.08

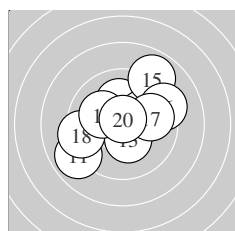

Serie 2:
 8.9 ↙ 10.1 ↑ 10.3 * 10.1 → 8.9 ↗
 9.3 → 9.9 → 9.3 ← 10.1 ↖ 10.8 *
 beste Teiler 48.0 (20.) 152.5 (13.) 209.7 (12.)
 Trefferlage 0.13 mm rechts, 0.57 mm hoch
 Streuwert 2.43, horizontal: 2.79, vertikal: 2.01

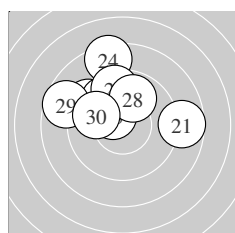

Serie 3:
 8.7 → 9.4 ↖ 10.4 * 8.4 ↑ 9.8 ↘
 9.8 ↑ 9.5 ↑ 9.9 ↑ 8.7 ↖ 9.9 ↖
 beste Teiler 126.5 (23.) 267.4 (30.) 270.9 (28.)
 Trefferlage 0.94 mm links, 2.34 mm hoch
 Streuwert 2.38, horizontal: 2.90, vertikal: 1.71

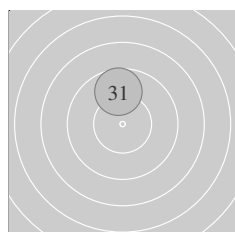

Serie 4:
 0.0+ ↑
 beste Teiler ^{AST.NSC}
 Trefferlage 0.00 mm , 0.00 mm
 Streuwert 0.00, horizontal: 0.00, vertikal: 0.00

AST – Treffer wurde nach Ende der Schießzeit abgegeben
 NSC – Treffer wurde vermessen, geht aber nicht in die Wertung ein

Unterschrift des Schützen

Ergebnis: **313.9** (298)
 Serien: 104.5 105.1 104.3
 Zähler: 28 2 0 0 0 0 0 0 0 0
 Innenzehner: 27
 weiteste: 295 (10), 262 (24), 222 (16)
 beste Teiler 27.1 (13.) 44.2 (30.) 44.4 (19.)
 Trefferlage 0.33 mm links, 0.07 mm hoch
 Streuwert 0.96, horizontal: 1.01, vertikal: 0.92

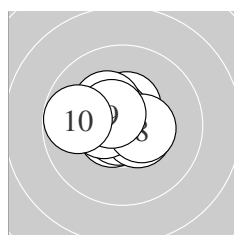
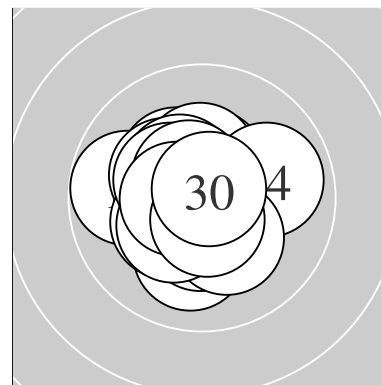

Serie 1:
 10.6 * 10.4 * 10.7 * 10.8 * 10.3 *
 10.5 * 10.5 * 10.4 * 10.5 * 9.8 ←
 beste Teiler 45.8 (4.) 73.8 (3.) 84.2 (1.)
 Trefferlage 0.47 mm links, 0.27 mm hoch
 Streuwert 0.97, horizontal: 1.19, vertikal: 0.69

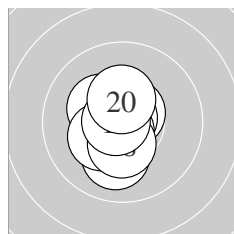

Serie 2:
 10.6 * 10.7 * 10.8 * 10.3 * 10.7 *
 10.1 ↓ 10.3 * 10.4 * 10.8 * 10.4 *
 beste Teiler 27.1 (13.) 44.4 (19.) 61.6 (15.)
 Trefferlage 0.36 mm links, 0.11 mm tief
 Streuwert 0.91, horizontal: 0.61, vertikal: 1.14

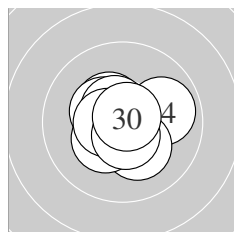

Serie 3:
 10.5 * 10.4 * 10.4 * 9.9 → 10.2 *
 10.3 * 10.6 * 10.6 * 10.6 * 10.8 *
 beste Teiler 44.2 (30.) 87.5 (29.) 95.4 (27.)
 Trefferlage 0.17 mm links, 0.08 mm hoch
 Streuwert 1.07, horizontal: 1.20, vertikal: 0.92

Unterschrift des Schützen

Meyton Elektronik

Ergebnis: **309.8** (299)
 Serien: 103.1 102.9 103.8
 Zähler: 29 1 0 0 0 0 0 0 0 0
 Innenzehner: 23
 weiteste: 322 (7), 233 (15), 223 (25)
 beste Teiler 9.2 (6.) 62.0 (22.) 62.9 (5.)
 Trefferlage 0.15 mm rechts, 0.77 mm hoch
 Streuwert 1.07, horizontal: 1.17, vertikal: 0.96

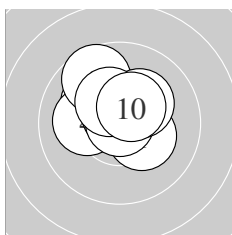
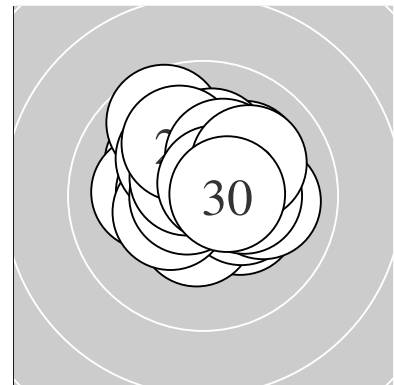

Serie 1:
 10.3 * 10.4 * 10.1 ↘ 10.1 ← 10.7 *
 10.9 * 9.7 ↘ 10.2 * 10.3 * 10.4 *
 beste Teiler 9.2 (6.) 62.9 (5.) 129.8 (10.)
 Trefferlage 0.16 mm links, 0.90 mm hoch
 Streuwert 1.14, horizontal: 1.27, vertikal: 0.98

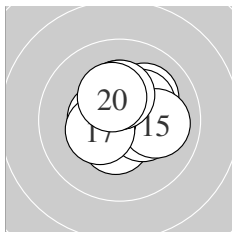

Serie 2:
 10.4 * 10.3 * 10.1 ↗ 10.3 * 10.0 →
 10.5 * 10.4 * 10.3 * 10.3 * 10.3 *
 beste Teiler 114.8 (16.) 129.4 (11.) 141.7 (17.)
 Trefferlage 0.36 mm rechts, 0.48 mm hoch
 Streuwert 1.17, horizontal: 1.25, vertikal: 1.09

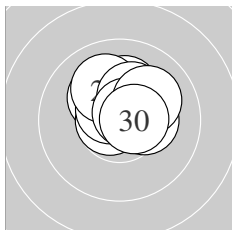

Serie 3:
 10.2 * 10.7 * 10.6 * 10.2 * 10.1 ↘
 10.3 * 10.3 * 10.7 * 10.1 ↗ 10.6 *
 beste Teiler 62.0 (22.) 67.8 (28.) 93.6 (23.)
 Trefferlage 0.25 mm rechts, 0.94 mm hoch
 Streuwert 0.93, horizontal: 1.04, vertikal: 0.80

Unterschrift des Schützen

Ergebnis: **309.3** (295)
 Serien: 103.4 104.4 101.5
 Zähler: 25 5 0 0 0 0 0 0 0 0
 Innenzehner: 20
 weiteste: 354 (26), 318 (30), 275 (23)
 beste Teiler 31.7 (5.) 50.6 (28.) 51.6 (16.)
 Trefferlage 0.55 mm links, 0.11 mm tief
 Streuwert 1.25, horizontal: 1.12, vertikal: 1.38

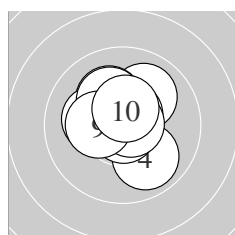
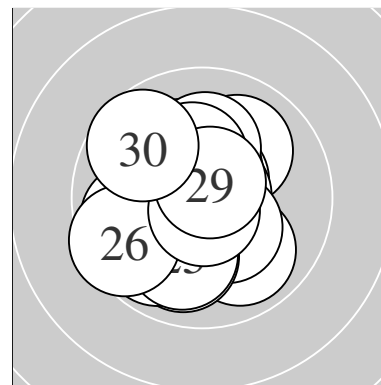

Serie 1:
 10.0 ↗ 10.2 * 10.6 * 9.9 ↘ 10.8 *
 10.2 * 10.2 * 10.7 * 10.3 * 10.5 *
 beste Teiler 31.7 (5.) 55.9 (8.) 83.2 (3.)
 Trefferlage 0.10 mm links, 0.52 mm hoch
 Streuwert 1.18, horizontal: 1.17, vertikal: 1.20

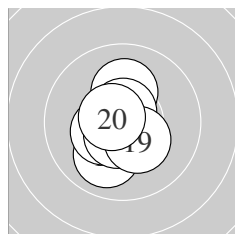

Serie 2:
 10.1 ↑ 10.4 * 10.6 * 10.0 ↓ 10.4 *
 10.7 * 10.7 * 10.6 * 10.3 * 10.6 *
 beste Teiler 51.6 (16.) 70.1 (17.) 79.6 (20.)
 Trefferlage 0.34 mm links, 0.32 mm tief
 Streuwert 0.97, horizontal: 0.68, vertikal: 1.19

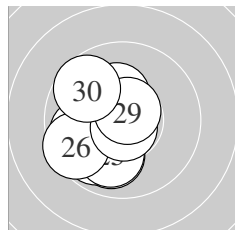

Serie 3:
 10.0 ↓ 10.7 * 9.9 ↙ 9.9 ← 10.0 ↓
 9.5 ↖ 10.3 * 10.8 * 10.7 * 9.7 ↘
 beste Teiler 50.6 (28.) 69.7 (29.) 74.0 (22.)
 Trefferlage 1.22 mm links, 0.53 mm tief
 Streuwert 1.41, horizontal: 1.18, vertikal: 1.61

Unterschrift des Schützen

Meyton Elektronik

Ergebnis: **300.0** (287)
 Serien: 100.8 99.9 99.3
 Zähler: 17 13 0 0 0 0 0 0 0 0
 Innenzehner: 12
 weiteste: 498 (15), 483 (19), 437 (28)
 beste Teiler 23.3 (8.) 24.0 (20.) 93.4 (2.)
 Trefferlage 0.39 mm rechts, 0.70 mm hoch
 Streuwert 1.82, horizontal: 2.07, vertikal: 1.54

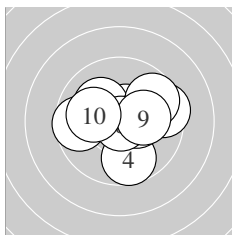
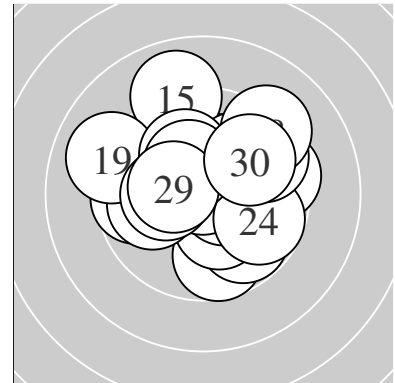

Serie 1:
 9.6 ← 10.6 * 10.1 ↖ 9.7 ↓ 10.4 *
 9.5 → 9.7 ↗ 10.9 * 10.2 * 10.1 ←
 beste Teiler 23.3 (8.) 93.4 (2.) 141.0 (5.)
 Trefferlage 0.39 mm rechts, 0.21 mm hoch
 Streuwert 1.79, horizontal: 2.18, vertikal: 1.30

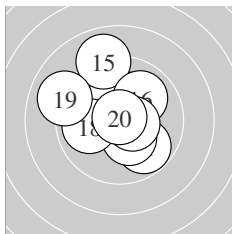

Serie 2:
 9.8 ↘ 10.3 * 10.2 * 10.3 * 9.0 ↑
 10.0 ↗ 10.5 * 9.9 ← 9.0 ↖ 10.9 *
 beste Teiler 24.0 (20.) 109.8 (17.) 160.2 (14.)
 Trefferlage 0.26 mm links, 0.74 mm hoch
 Streuwert 2.01, horizontal: 2.02, vertikal: 2.00

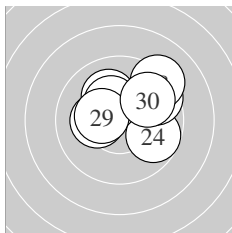

Serie 3:
 10.1 ↗ 9.9 ↗ 10.2 * 9.7 ↘ 10.1 ↖
 9.6 ↗ 10.3 * 9.2 ↗ 10.4 * 9.8 ↗
 beste Teiler 149.9 (29.) 155.6 (27.) 183.0 (23.)
 Trefferlage 1.04 mm rechts, 1.15 mm hoch
 Streuwert 1.65, horizontal: 2.00, vertikal: 1.21

Unterschrift des Schützen

Ergebnis: **308.0** (294)
 Serien: 102.5 101.5 104.0
 Zähler: 24 6 0 0 0 0 0 0 0 0
 Innenzehner: 19
 weiteste: 314 (15), 298 (20), 277 (18)
 beste Teiler 36.6 (19.) 42.5 (8.) 59.4 (21.)
 Trefferlage 0.03 mm links, 0.14 mm hoch
 Streuwert 1.35, horizontal: 1.26, vertikal: 1.44

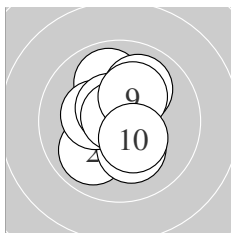
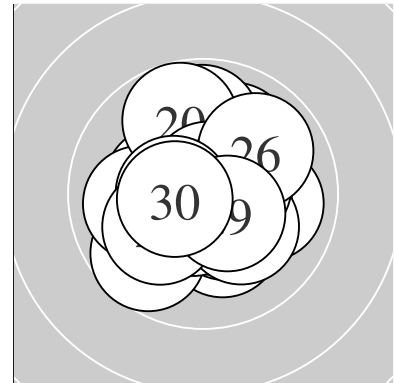

Serie 1:
 10.3 * 9.9 ↙ 10.2 * 9.9 ↑ 10.3 *
 10.5 * 10.0 ↗ 10.8 * 10.2 * 10.4 *
 beste Teiler 42.5 (8.) 105.8 (6.) 140.8 (10.)
 Trefferlage 0.25 mm links, 0.20 mm hoch
 Streuwert 1.36, horizontal: 1.11, vertikal: 1.57

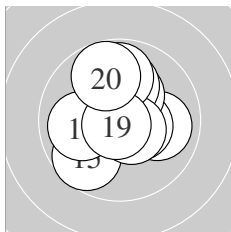

Serie 2:
 10.0 → 10.4 * 10.3 * 10.1 ↑ 9.7 ↙
 10.6 * 10.0 ← 9.8 ↑ 10.8 * 9.8 ↑
 beste Teiler 36.6 (19.) 98.8 (16.) 126.5 (12.)
 Trefferlage 0.02 mm links, 0.51 mm hoch
 Streuwert 1.61, horizontal: 1.48, vertikal: 1.73

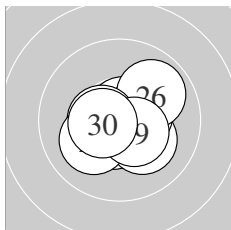

Serie 3:
 10.7 * 10.6 * 10.5 * 10.2 * 10.5 *
 9.9 ↗ 10.5 * 10.1 ↙ 10.5 * 10.5 *
 beste Teiler 59.4 (21.) 93.6 (22.) 101.7 (23.)
 Trefferlage 0.18 mm rechts, 0.27 mm tief
 Streuwert 1.10, horizontal: 1.24, vertikal: 0.94

Unterschrift des Schützen

Ergebnis: **300.5** (284)
 Serien: 102.6 101.1 96.8
 Zähler: 16 12 2 0 0 0 0 0 0 0
 Innenzehner: 13
 weiteste: 576 (23), 526 (22), 495 (29)
 beste Teiler 14.8 (4.) 48.6 (7.) 57.8 (2.)
 Trefferlage 0.51 mm links, 0.47 mm hoch
 Streuwert 1.89, horizontal: 2.19, vertikal: 1.54

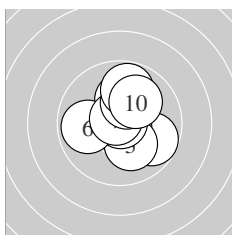
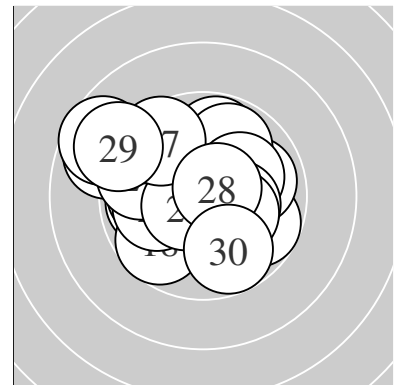

Serie 1:
 9.8 ↘ 10.7 * 10.2 * 10.9 * 10.2 *
 9.9 ← 10.8 * 10.2 * 9.8 ↑ 10.1 ↗
 beste Teiler 14.8 (4.) 48.6 (7.) 57.8 (2.)
 Trefferlage 0.39 mm rechts, 0.50 mm hoch
 Streuwert 1.44, horizontal: 1.36, vertikal: 1.51

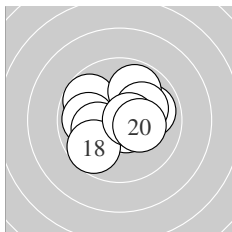

Serie 2:
 9.8 ↘ 10.7 * 9.9 ← 9.9 → 9.9 ↗
 10.2 * 10.1 ↗ 9.7 ↙ 10.6 * 10.3 *
 beste Teiler 74.3 (12.) 80.2 (19.) 172.6 (20.)
 Trefferlage 0.05 mm links, 0.20 mm hoch
 Streuwert 1.70, horizontal: 2.01, vertikal: 1.32

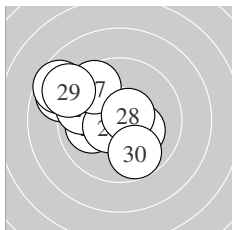

Serie 3:
 10.0 ← 8.8 ↖ 8.6 ↖ 9.6 ↖ 10.6 *
 10.2 * 9.6 ↖ 10.6 * 9.0 ↖ 9.8 ↘
 beste Teiler 82.4 (28.) 100.3 (25.) 180.7 (26.)
 Trefferlage 1.90 mm links, 0.70 mm hoch
 Streuwert 2.20, horizontal: 2.50, vertikal: 1.85

Unterschrift des Schützen

Ergebnis: **306.1** (293)
 Serien: 99.8 102.5 103.8
 Zähler: 23 7 0 0 0 0 0 0 0 0
 Innenzehner: 16
 weiteste: 444 (19), 386 (8), 365 (22)
 beste Teiler 6.4 (11.) 17.0 (20.) 49.1 (24.)
 Trefferlage 0.40 mm links, 0.59 mm hoch
 Streuwert 1.49, horizontal: 1.63, vertikal: 1.33

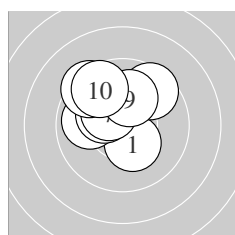
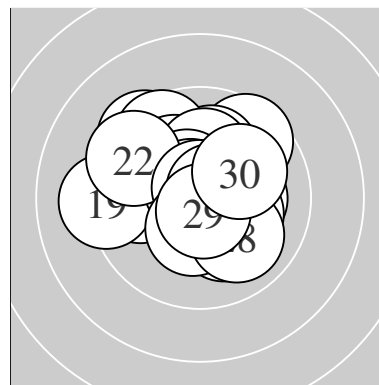

Serie 1:
 10.3 * 10.1 ↑ 10.1 ↘ 9.9 ← 10.3 *
 9.6 ↗ 10.4 * 9.4 ↙ 10.1 ↑ 9.6 ↘
 beste Teiler 148.5 (7.) 160.7 (1.) 167.9 (5.)
 Trefferlage 0.76 mm links, 1.51 mm hoch
 Streuwert 1.44, horizontal: 1.53, vertikal: 1.34

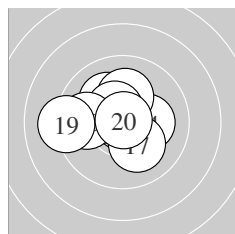

Serie 2:
 10.9 * 10.1 ↘ 10.6 * 10.2 * 10.2 *
 10.5 * 10.1 ↓ 9.8 ← 9.2 ← 10.9 *
 beste Teiler 6.4 (11.) 17.0 (20.) 92.9 (13.)
 Trefferlage 0.66 mm links, 0.35 mm hoch
 Streuwert 1.50, horizontal: 1.84, vertikal: 1.04

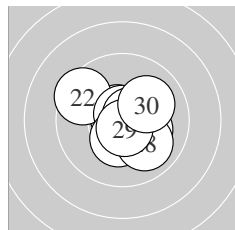

Serie 3:
 10.7 * 9.5 ↖ 10.7 * 10.8 * 10.2 *
 10.4 * 10.7 * 10.0 ↘ 10.7 * 10.1 ↗
 beste Teiler 49.1 (24.) 64.0 (29.) 69.0 (21.)
 Trefferlage 0.21 mm rechts, 0.08 mm tief
 Streuwert 1.33, horizontal: 1.47, vertikal: 1.17

Unterschrift des Schützen

Meyton Elektronik

Ergebnis: **312.0** (295)
 Serien: 104.0 104.9 103.1
 Zähler: 25 5 0 0 0 0 0 0 0 0
 Innenzehner: 23
 weiteste: 304 (25), 273 (28), 267 (23)
 beste Teiler 10.4 (5.) 19.4 (16.) 26.4 (14.)
 Trefferlage 0.25 mm rechts, 0.03 mm hoch
 Streuwert 1.13, horizontal: 1.06, vertikal: 1.19

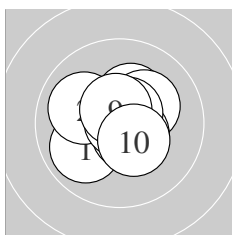
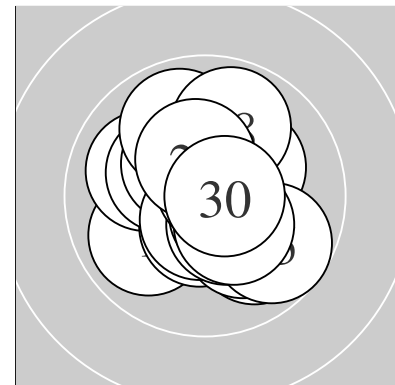

Serie 1:
 9.9 ↙ 10.0 ↖ 10.6 * 10.3 * 10.9 *
 10.2 * 10.5 * 10.6 * 10.6 * 10.4 *
 beste Teiler 10.4 (5.) 76.8 (8.) 81.2 (3.)
 Trefferlage 0.03 mm rechts, 0.12 mm hoch
 Streuwert 1.14, horizontal: 1.25, vertikal: 1.02

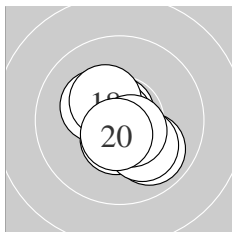

Serie 2:
 10.5 * 9.9 ↘ 10.8 * 10.8 * 10.1 ↘
 10.9 * 10.3 * 10.4 * 10.6 * 10.6 *
 beste Teiler 19.4 (16.) 26.4 (14.) 46.8 (13.)
 Trefferlage 0.07 mm rechts, 0.33 mm tief
 Streuwert 1.02, horizontal: 1.00, vertikal: 1.03

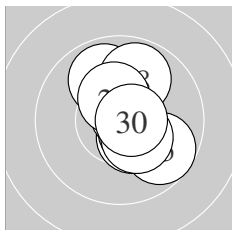

Serie 3:
 10.4 * 10.5 * 9.9 ↗ 10.6 * 9.7 ↘
 10.7 * 10.3 * 9.9 ↑ 10.4 * 10.7 *
 beste Teiler 57.9 (26.) 73.0 (30.) 85.4 (24.)
 Trefferlage 0.64 mm rechts, 0.30 mm hoch
 Streuwert 1.24, horizontal: 0.91, vertikal: 1.50

Unterschrift des Schützen

Ergebnis: **309.6** (296)
 Serien: 104.3 102.2 103.1
 Zähler: 26 4 0 0 0 0 0 0 0 0
 Innenzehner: 22
 weiteste: 338 (29), 308 (17), 284 (27)
 beste Teiler 34.5 (25.) 67.0 (8.) 72.8 (21.)
 Trefferlage 0.63 mm rechts, 0.06 mm hoch
 Streuwert 1.18, horizontal: 1.25, vertikal: 1.09

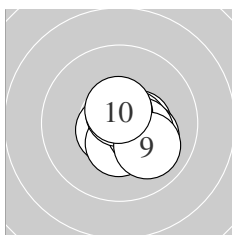
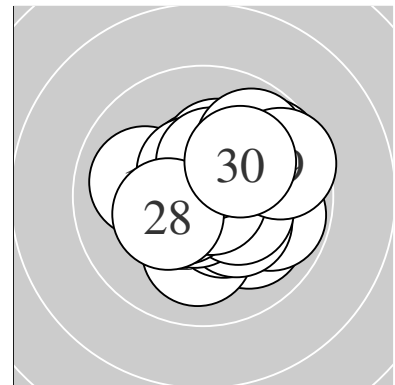

Serie 1:
 10.3 * 10.5 * 10.2 * 10.6 * 10.6 *
 10.4 * 10.4 * 10.7 * 10.0 ↘ 10.6 *
 beste Teiler 67.0 (8.) 84.5 (4.) 89.4 (10.)
 Trefferlage 0.78 mm rechts, 0.39 mm tief
 Streuwert 0.85, horizontal: 0.92, vertikal: 0.78

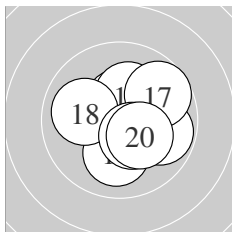

Serie 2:
 10.7 * 10.5 * 9.8 ↘ 10.5 * 10.1 ↓
 10.2 * 9.7 ↗ 10.0 ← 10.4 * 10.3 *
 beste Teiler 74.2 (11.) 101.8 (12.) 117.2 (14.)
 Trefferlage 0.56 mm rechts, 0.13 mm hoch
 Streuwert 1.41, horizontal: 1.49, vertikal: 1.32

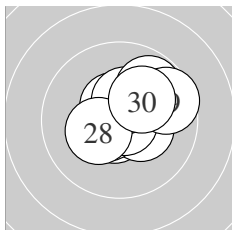

Serie 3:
 10.7 * 10.3 * 10.6 * 10.5 * 10.8 *
 10.4 * 9.8 ↗ 10.3 * 9.6 → 10.1 ↗
 beste Teiler 34.5 (25.) 72.8 (21.) 97.4 (23.)
 Trefferlage 0.56 mm rechts, 0.44 mm hoch
 Streuwert 1.24, horizontal: 1.41, vertikal: 1.06

Unterschrift des Schützen

Ergebnis: **307.2** (290)
 Serien: 102.5 103.2 101.5
 Zähler: 20 10 0 0 0 0 0 0 0 0
 Innenzehner: 20
 weiteste: 431 (28), 366 (17), 319 (4)
 beste Teiler 41.0 (7.) 57.2 (9.) 63.1 (14.)
 Trefferlage 0.60 mm links, 0.32 mm hoch
 Streuwert 1.40, horizontal: 1.54, vertikal: 1.26

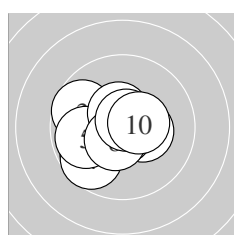
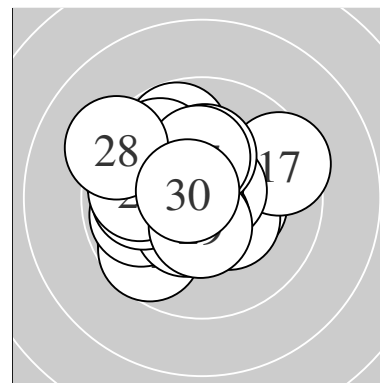

Serie 1:
 9.8 ↙ 10.4 * 9.7 ↖ 9.7 ↙ 9.9 ←
 10.5 * 10.8 * 10.5 * 10.7 * 10.5 *
 beste Teiler 41.0 (7.) 57.2 (9.) 104.4 (8.)
 Trefferlage 0.80 mm links, 0.34 mm tief
 Streuwert 1.40, horizontal: 1.61, vertikal: 1.14

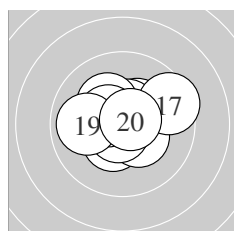

Serie 2:
 10.4 * 10.4 * 10.4 * 10.7 * 10.5 *
 10.2 * 9.5 → 10.5 * 9.9 ← 10.7 *
 beste Teiler 63.1 (14.) 65.8 (20.) 106.6 (15.)
 Trefferlage 0.07 mm rechts, 0.33 mm hoch
 Streuwert 1.33, horizontal: 1.61, vertikal: 0.96

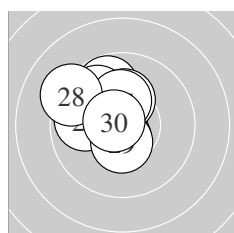

Serie 3:
 10.6 * 9.8 ↖ 10.6 * 9.8 ↖ 9.9 ←
 10.2 * 10.2 * 9.2 ↖ 10.5 * 10.7 *
 beste Teiler 69.7 (30.) 86.3 (23.) 96.3 (21.)
 Trefferlage 1.06 mm links, 0.98 mm hoch
 Streuwert 1.33, horizontal: 1.29, vertikal: 1.36

Unterschrift des Schützen

Ergebnis: **297.6** (286)
 Serien: 96.5 98.0 103.1
 Zähler: 18 10 2 0 0 0 0 0 0 0
 Innenzehner: 13
 weiteste: 687 (5), 545 (6), 477 (19)
 beste Teiler 47.0 (21.) 96.1 (23.) 110.1 (16.)
 Trefferlage 1.87 mm links, 0.02 mm tief
 Streuwert 1.66, horizontal: 1.75, vertikal: 1.56

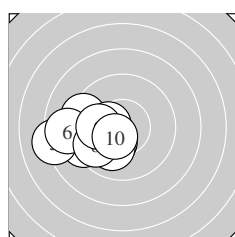
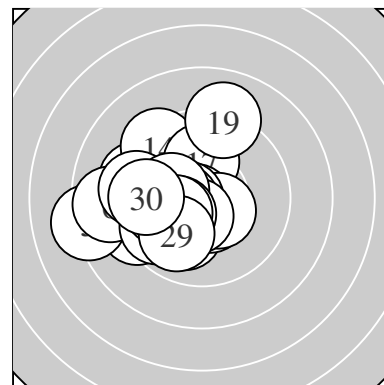

Serie 1:
 9.3 ↖ 10.3 * 10.4 * 9.3 ↖ 8.2 ↖
 8.8 ← 10.0 ↙ 9.7 ↙ 10.0 ← 10.5 *
 beste Teiler 119.9 (10.) 143.3 (3.) 169.5 (2.)
 Trefferlage 2.89 mm links, 0.83 mm tief
 Streuwert 1.63, horizontal: 2.05, vertikal: 1.04

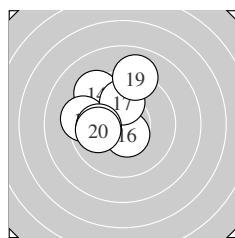

Serie 2:
 9.9 ↘ 9.6 ↘ 10.2 * 9.3 ↘ 9.4 ↖
 10.5 * 10.1 ↑ 10.0 ← 9.0 ↑ 10.0 ←
 beste Teiler 110.1 (16.) 180.7 (13.) 216.0 (17.)
 Trefferlage 1.55 mm links, 1.33 mm hoch
 Streuwert 1.69, horizontal: 1.61, vertikal: 1.77

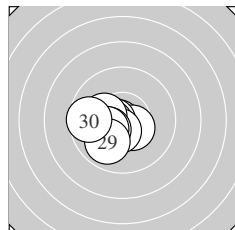

Serie 3:
 10.8 * 10.5 * 10.6 * 10.5 * 10.5 *
 10.2 * 10.3 * 10.2 * 9.9 ↙ 9.6 ←
 beste Teiler 47.0 (21.) 96.1 (23.) 113.5 (25.)
 Trefferlage 1.17 mm links, 0.58 mm tief
 Streuwert 0.94, horizontal: 1.11, vertikal: 0.73

Unterschrift des Schützen

Meyton Elektronik

Ergebnis: **294.8** (283)
 Serien: 99.2 98.6 97.0
 Zähler: 14 15 1 0 0 0 0 0 0 0
 Innenzehner: 8
 weiteste: 639 (24), 442 (14), 425 (1)
 beste Teiler 144.8 (7.) 145.0 (2.) 156.0 (23.)
 Trefferlage 0.77 mm rechts, 0.20 mm hoch
 Streuwert 2.11, horizontal: 2.61, vertikal: 1.44

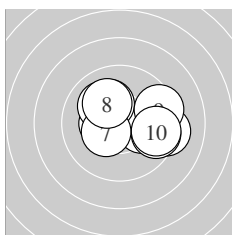
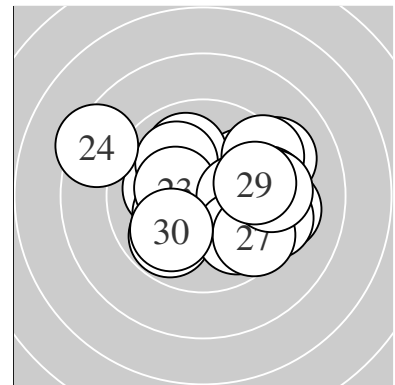

Serie 1:
 9.3 → 10.4 * 10.1 → 10.2 * 10.1 ↖
 9.6 → 10.4 * 10.1 ↖ 9.4 → 9.6 →
 beste Teiler 144.8 (7.) 145.0 (2.) 194.5 (4.)
 Trefferlage 1.00 mm rechts, 0.26 mm hoch
 Streuwert 1.92, horizontal: 2.45, vertikal: 1.16

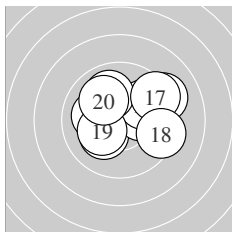

Serie 2:
 10.2 * 10.2 * 10.1 ← 9.2 ↗ 9.9 ↗
 10.0 ↘ 9.4 ↗ 9.4 → 10.2 * 10.0 ↘
 beste Teiler 184.7 (19.) 193.1 (11.) 195.5 (12.)
 Trefferlage 0.74 mm rechts, 0.69 mm hoch
 Streuwert 2.02, horizontal: 2.47, vertikal: 1.44

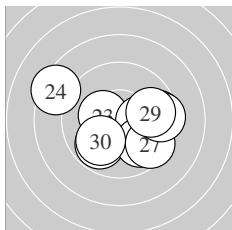

Serie 3:
 9.6 → 9.8 ↙ 10.3 * 8.4 ↖ 10.2 *
 9.9 ↘ 9.6 ↘ 9.5 → 9.8 → 9.9 ↙
 beste Teiler 156.0 (23.) 189.0 (25.) 252.6 (30.)
 Trefferlage 0.57 mm rechts, 0.36 mm tief
 Streuwert 2.48, horizontal: 3.11, vertikal: 1.63

Unterschrift des Schützen

Ergebnis: **307.2** (293)
 Serien: 101.8 103.6 101.8
 Zähler: 23 7 0 0 0 0 0 0 0 0
 Innenzehner: 19
 weiteste: 428 (22), 309 (15), 305 (11)
 beste Teiler 40.1 (17.) 47.4 (16.) 55.9 (2.)
 Trefferlage 0.79 mm links, 0.03 mm tief
 Streuwert 1.31, horizontal: 1.34, vertikal: 1.29

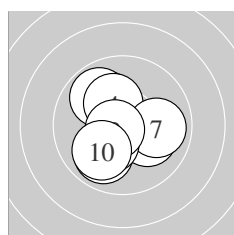
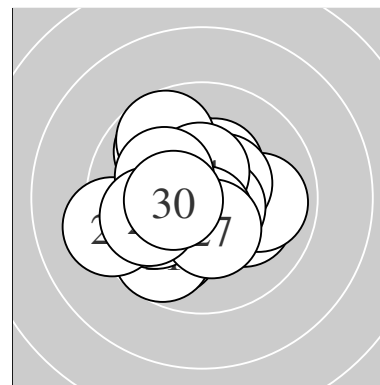

Serie 1:
 10.1 ↖ 10.7 * 9.9 ↖ 10.2 * 9.9 ↘
 10.1 ↗ 9.9 → 10.3 * 10.7 * 10.0 ↘
 beste Teiler 55.9 (2.) 67.6 (9.) 171.2 (8.)
 Trefferlage 0.44 mm links, 0.11 mm tief
 Streuwert 1.51, horizontal: 1.47, vertikal: 1.55

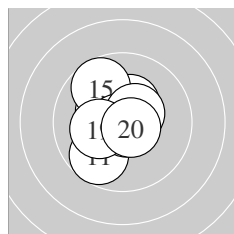

Serie 2:
 9.7 ↘ 10.4 * 10.3 * 10.5 * 9.7 ↖
 10.8 * 10.8 * 10.5 * 10.2 * 10.7 *
 beste Teiler 40.1 (17.) 47.4 (16.) 75.1 (20.)
 Trefferlage 0.51 mm links, 0.25 mm hoch
 Streuwert 1.23, horizontal: 1.07, vertikal: 1.37

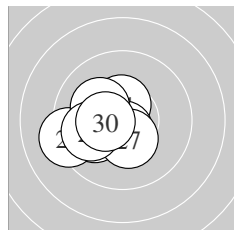

Serie 3:
 10.0 ← 9.2 ← 10.3 * 10.5 * 10.3 *
 10.6 * 10.4 * 10.2 * 9.9 ← 10.4 *
 beste Teiler 79.2 (26.) 117.4 (24.) 130.4 (30.)
 Trefferlage 1.42 mm links, 0.25 mm tief
 Streuwert 1.16, horizontal: 1.33, vertikal: 0.96

Unterschrift des Schützen

Ergebnis: **302.9** (292)
 Serien: 100.8 99.6 102.5
 Zähler: 22 8 0 0 0 0 0 0 0 0
 Innenzehner: 13
 weiteste: 387 (22), 372 (17), 367 (11)
 beste Teiler 52.3 (16.) 74.4 (21.) 87.8 (24.)
 Trefferlage 0.99 mm links, 0.63 mm tief
 Streuwert 1.43, horizontal: 1.66, vertikal: 1.16

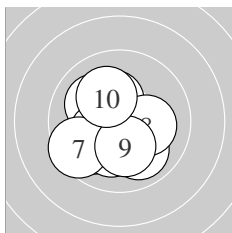
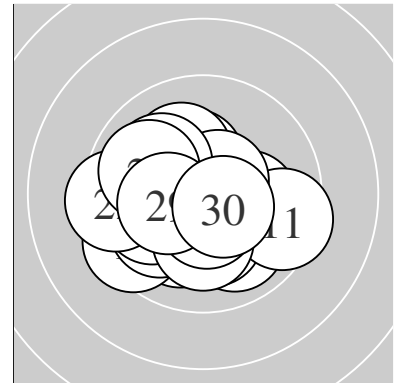

Serie 1:
 10.0 ↘ 10.3 * 10.1 ↖ 9.9 ↙ 10.2 *
 10.3 * 9.5 ↗ 10.2 * 10.2 * 10.1 ↖
 beste Teiler 157.2 (2.) 168.5 (6.) 188.7 (9.)
 Trefferlage 0.64 mm links, 0.60 mm tief
 Streuwert 1.56, horizontal: 1.55, vertikal: 1.56

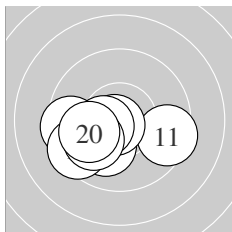

Serie 2:
 9.5 → 9.9 ↙ 10.0 ↙ 10.1 ↓ 9.5 ←
 10.7 * 9.5 ↙ 10.4 * 10.0 ↙ 10.0 ←
 beste Teiler 52.3 (16.) 126.2 (18.) 214.2 (14.)
 Trefferlage 1.41 mm links, 1.12 mm tief
 Streuwert 1.46, horizontal: 1.97, vertikal: 0.60

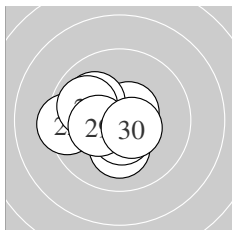

Serie 3:
 10.7 * 9.4 ← 10.4 * 10.6 * 10.1 ↓
 10.1 ↖ 10.5 * 9.9 ↖ 10.3 * 10.5 *
 beste Teiler 74.4 (21.) 87.8 (24.) 105.6 (30.)
 Trefferlage 0.93 mm links, 0.18 mm tief
 Streuwert 1.29, horizontal: 1.52, vertikal: 1.02

Unterschrift des Schützen

Ergebnis: **303.1** (292)
 Serien: 100.3 100.2 102.6
 Zähler: 23 6 1 0 0 0 0 0 0 0
 Innenzehner: 16
 weiteste: 545 (5), 407 (4), 407 (14)
 beste Teiler 49.5 (1.) 58.0 (19.) 82.1 (2.)
 Trefferlage 0.90 mm links, 0.14 mm hoch
 Streuwert 1.59, horizontal: 1.96, vertikal: 1.11

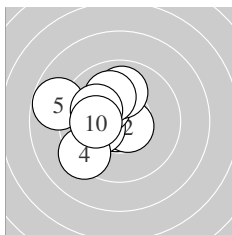
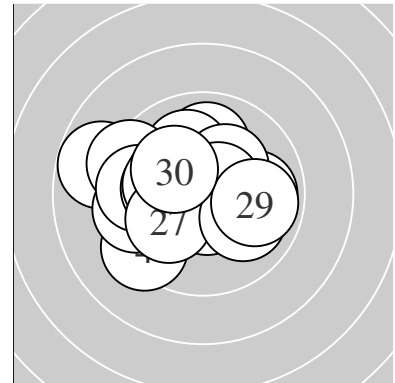

Serie 1:
 10.8 * 10.6 * 10.2 * 9.3 ↙ 8.8 ↖
 10.3 * 10.0 ↑ 10.1 ↘ 10.1 ↖ 10.1 ←
 beste Teiler 49.5 (1.) 82.1 (2.) 173.9 (6.)
 Trefferlage 1.55 mm links, 0.40 mm hoch
 Streuwert 1.64, horizontal: 1.72, vertikal: 1.55

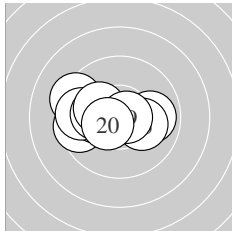

Serie 2:
 9.5 ← 9.9 → 10.2 * 9.3 ↖ 10.2 *
 9.6 ← 10.1 ← 10.2 * 10.7 * 10.5 *
 beste Teiler 58.0 (19.) 117.7 (20.) 189.7 (18.)
 Trefferlage 1.21 mm links, 0.09 mm hoch
 Streuwert 1.66, horizontal: 2.24, vertikal: 0.70

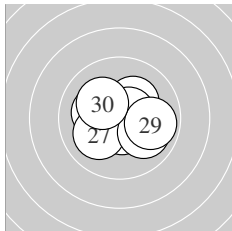

Serie 3:
 10.2 * 10.6 * 10.2 * 10.6 * 10.2 *
 10.6 * 10.1 ↙ 10.0 ↘ 9.9 → 10.2 *
 beste Teiler 88.5 (26.) 90.0 (22.) 92.4 (24.)
 Trefferlage 0.05 mm rechts, 0.06 mm tief
 Streuwert 1.38, horizontal: 1.68, vertikal: 0.98

Unterschrift des Schützen

Ergebnis: **298.6** (281)
 Serien: 101.4 97.5 99.7
 Zähler: 13 15 2 0 0 0 0 0 0 0
 Innenzehner: 9
 weiteste: 542 (20), 513 (13), 370 (3)
 beste Teiler 24.3 (12.) 32.2 (27.) 53.9 (10.)
 Trefferlage 0.19 mm links, 0.97 mm tief
 Streuwert 1.88, horizontal: 1.82, vertikal: 1.93

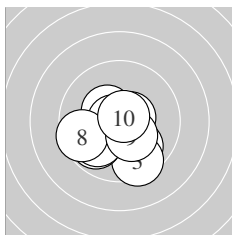
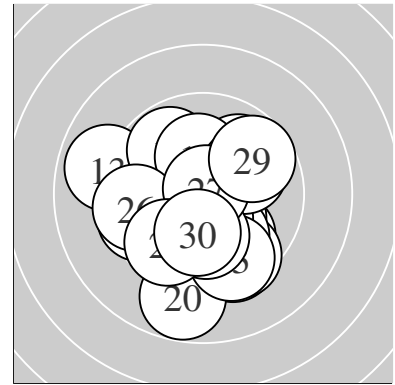

Serie 1:
 10.4 * 9.9 ↘ 9.5 ↘ 9.8 ↙ 10.7 *
 10.6 * 9.9 ↙ 9.6 ↙ 10.3 * 10.7 *
 beste Teiler 53.9 (10.) 54.1 (5.) 94.2 (6.)
 Trefferlage 0.34 mm links, 0.99 mm tief
 Streuwert 1.53, horizontal: 1.68, vertikal: 1.36

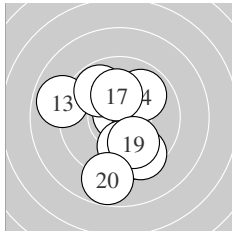

Serie 2:
 9.6 ↘ 10.9 * 8.9 ↖ 9.9 ↗ 9.9 ↓
 9.8 ↘ 10.2 * 9.5 ↘ 10.0 ↘ 8.8 ↓
 beste Teiler 24.3 (12.) 194.7 (17.) 250.5 (19.)
 Trefferlage 0.17 mm links, 0.86 mm tief
 Streuwert 2.40, horizontal: 2.05, vertikal: 2.71

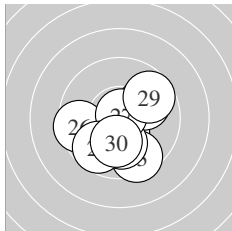

Serie 3:
 10.4 * 10.0 ↗ 9.5 ↘ 9.9 ↙ 10.1 ↓
 9.5 ↖ 10.8 * 9.7 ↙ 9.7 ↗ 10.1 ↓
 beste Teiler 32.2 (27.) 130.7 (21.) 203.0 (30.)
 Trefferlage 0.07 mm links, 1.05 mm tief
 Streuwert 1.80, horizontal: 1.91, vertikal: 1.68

Unterschrift des Schützen

Ergebnis: **311.1** (298)
 Serien: 103.8 104.3 103.0
 Zähler: 28 2 0 0 0 0 0 0 0 0
 Innenzehner: 24
 weiteste: 333 (21), 256 (19), 231 (7)
 beste Teiler 42.4 (1.) 50.0 (12.) 53.0 (29.)
 Trefferlage 0.47 mm links, 0.29 mm tief
 Streuwert 1.07, horizontal: 1.29, vertikal: 0.79

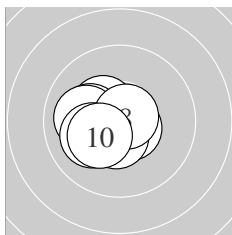
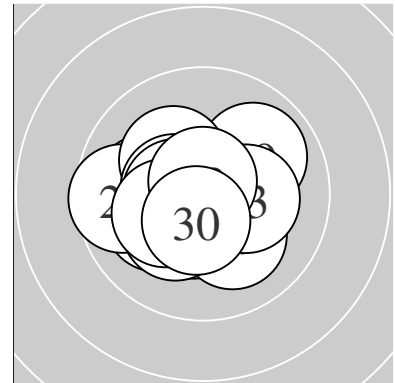

Serie 1:
 10.8 * 10.6 * 10.4 * 10.5 * 10.1 ←
 10.3 * 10.0 ← 10.7 * 10.1 ← 10.3 *
 beste Teiler 42.4 (1.) 53.8 (8.) 82.4 (2.)
 Trefferlage 0.93 mm links, 0.29 mm tief
 Streuwert 0.90, horizontal: 1.06, vertikal: 0.69

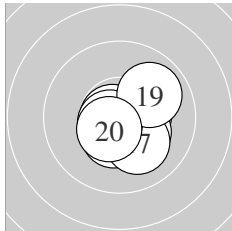

Serie 2:
 10.4 * 10.8 * 10.5 * 10.7 * 10.3 *
 10.4 * 10.1 ↘ 10.7 * 9.9 ↗ 10.5 *
 beste Teiler 50.0 (12.) 60.8 (14.) 75.6 (18.)
 Trefferlage 0.44 mm rechts, 0.38 mm tief
 Streuwert 0.99, horizontal: 1.07, vertikal: 0.91

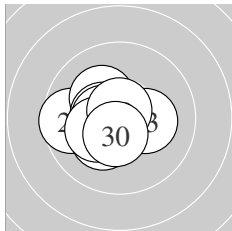

Serie 3:
 9.6 ← 10.2 * 10.2 * 10.5 * 10.5 *
 10.3 * 10.2 * 10.3 * 10.7 * 10.5 *
 beste Teiler 53.0 (29.) 109.0 (25.) 113.7 (30.)
 Trefferlage 0.93 mm links, 0.22 mm tief
 Streuwert 1.08, horizontal: 1.29, vertikal: 0.82

Unterschrift des Schützen

Ergebnis: **310.5** (296)
 Serien: 102.8 104.1 103.6
 Zähler: 26 4 0 0 0 0 0 0 0 0
 Innenzehner: 20
 weiteste: 339 (2), 308 (30), 279 (18)
 beste Teiler 44.2 (17.) 52.2 (23.) 55.4 (25.)
 Trefferlage 0.21 mm rechts, 0.76 mm tief
 Streuwert 1.10, horizontal: 1.11, vertikal: 1.09

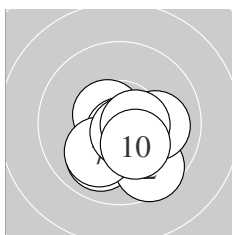
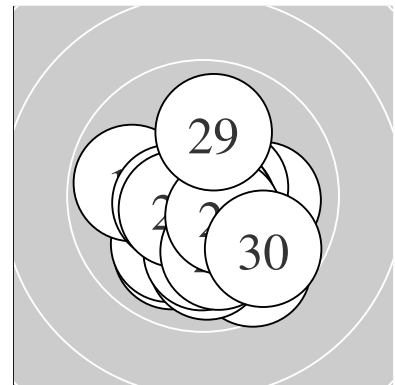

Serie 1:
 10.0 ↙ 9.6 ↘ 10.6 * 10.7 * 10.3 *
 10.0 → 10.0 ↙ 10.7 * 10.6 * 10.3 *
 beste Teiler 59.3 (4.) 66.3 (8.) 95.4 (3.)
 Trefferlage 0.42 mm rechts, 1.03 mm tief
 Streuwert 1.14, horizontal: 1.24, vertikal: 1.04

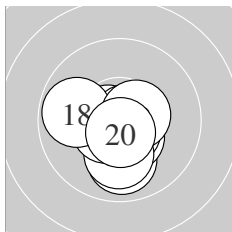

Serie 2:
 10.7 * 9.9 ↓ 10.5 * 10.6 * 10.1 ↓
 10.6 * 10.8 * 9.8 ← 10.5 * 10.6 *
 beste Teiler 44.2 (17.) 75.0 (11.) 80.2 (14.)
 Trefferlage 0.16 mm links, 0.69 mm tief
 Streuwert 1.05, horizontal: 1.08, vertikal: 1.01

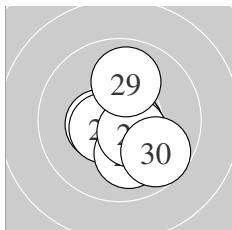

Serie 3:
 10.7 * 10.4 * 10.7 * 10.3 * 10.7 *
 10.5 * 10.1 ↓ 10.5 * 10.0 ↑ 9.7 ↘
 beste Teiler 52.2 (23.) 55.4 (25.) 68.7 (21.)
 Trefferlage 0.39 mm rechts, 0.56 mm tief
 Streuwert 1.15, horizontal: 1.01, vertikal: 1.27

Unterschrift des Schützen

Ergebnis: **302.4** (291)
 Serien: 101.7 99.8 100.9
 Zähler: 22 7 1 0 0 0 0 0 0 0
 Innenzehner: 18
 weiteste: 513 (25), 450 (14), 426 (27)
 beste Teiler 60.1 (30.) 66.8 (15.) 87.0 (10.)
 Trefferlage 0.34 mm rechts, 0.31 mm tief
 Streuwert 1.74, horizontal: 1.96, vertikal: 1.49

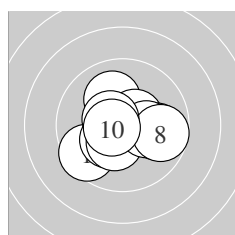
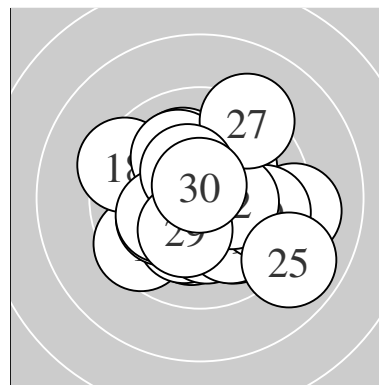

Serie 1:
 9.5 ↙ 10.3 * 10.1 ↖ 10.4 * 10.5 *
 9.9 → 10.2 * 9.7 → 10.5 * 10.6 *
 beste Teiler 87.0 (10.) 106.8 (9.) 112.6 (5.)
 Trefferlage 0.12 mm rechts, 0.31 mm tief
 Streuwert 1.57, horizontal: 1.89, vertikal: 1.17

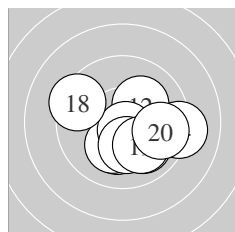

Serie 2:
 10.2 * 10.2 * 10.2 * 9.2 → 10.7 *
 10.0 ↘ 10.2 * 9.4 ↖ 10.0 ↘ 9.7 →
 beste Teiler 66.8 (15.) 183.8 (17.) 192.4 (11.)
 Trefferlage 0.77 mm rechts, 0.80 mm tief
 Streuwert 1.81, horizontal: 2.19, vertikal: 1.32

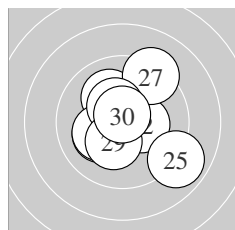

Serie 3:
 10.5 * 10.4 * 10.2 * 10.1 ↖ 8.9 ↘
 10.2 * 9.2 ↗ 10.4 * 10.3 * 10.7 *
 beste Teiler 60.1 (30.) 116.7 (21.) 138.2 (28.)
 Trefferlage 0.12 mm rechts, 0.18 mm hoch
 Streuwert 1.90, horizontal: 1.93, vertikal: 1.88

Unterschrift des Schützen

Meyton Elektronik

Ergebnis: **310.8** (300)
 Serien: 103.7 102.8 104.3
 Zähler: 30 0 0 0 0 0 0 0 0 0
 Innenzehner: 24
 weiteste: 245 (27), 222 (9), 213 (18)
 beste Teiler 43.0 (30.) 57.2 (3.) 61.3 (20.)
 Trefferlage 0.27 mm links, 0.10 mm hoch
 Streuwert 1.13, horizontal: 0.91, vertikal: 1.31

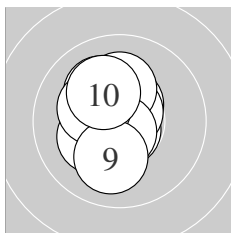
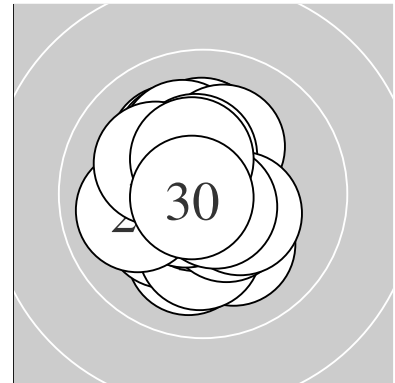

Serie 1:
 10.1 ↖ 10.2 * 10.7 * 10.5 * 10.7 *
 10.2 * 10.7 * 10.3 * 10.1 ↓ 10.2 *
 beste Teiler 57.2 (3.) 64.0 (7.) 69.0 (5.)
 Trefferlage 0.47 mm links, 0.35 mm hoch
 Streuwert 1.11, horizontal: 0.79, vertikal: 1.36

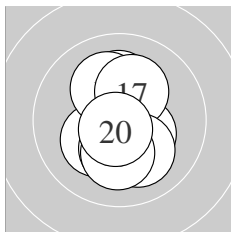

Serie 2:
 10.2 * 10.4 * 10.2 * 10.3 * 10.4 *
 10.1 ↖ 10.2 * 10.1 ↘ 10.2 * 10.7 *
 beste Teiler 61.3 (20.) 126.7 (15.) 145.0 (12.)
 Trefferlage 0.04 mm rechts, 0.12 mm tief
 Streuwert 1.30, horizontal: 0.80, vertikal: 1.65

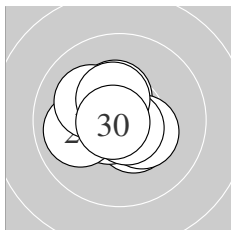

Serie 3:
 10.4 * 10.4 * 10.3 * 10.6 * 10.6 *
 10.7 * 10.0 ← 10.1 ↖ 10.4 * 10.8 *
 beste Teiler 43.0 (30.) 65.0 (26.) 76.2 (24.)
 Trefferlage 0.40 mm links, 0.08 mm hoch
 Streuwert 1.01, horizontal: 1.12, vertikal: 0.88

 Unterschrift des Schützen

Ergebnis: **310.7** (298)
 Serien: 102.7 104.1 103.9
 Zähler: 28 2 0 0 0 0 0 0 0 0
 Innenzehner: 27
 weiteste: 420 (6), 330 (23), 227 (18)
 beste Teiler 20.5 (8.) 32.8 (14.) 50.0 (22.)
 Trefferlage 0.32 mm rechts, 0.29 mm hoch
 Streuwert 1.17, horizontal: 1.43, vertikal: 0.84

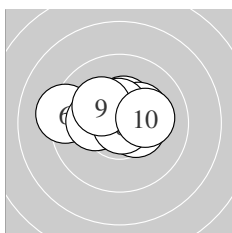
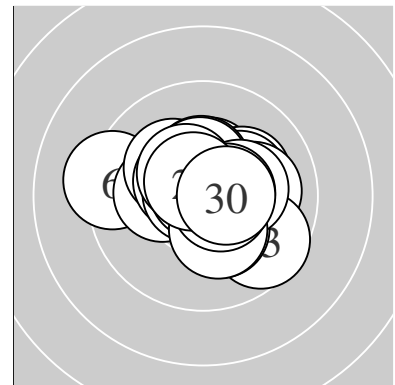

Serie 1:
 10.4 * 10.3 * 10.4 * 10.3 * 10.5 *
 9.3 ← 10.2 * 10.9 * 10.2 * 10.2 *
 beste Teiler 20.5 (8.) 117.3 (5.) 129.1 (3.)
 Trefferlage 0.40 mm links, 0.56 mm hoch
 Streuwert 1.38, horizontal: 1.86, vertikal: 0.60

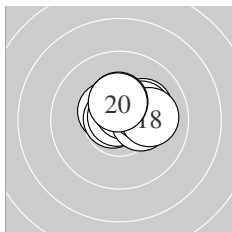

Serie 2:
 10.5 * 10.7 * 10.2 * 10.8 * 10.6 *
 10.3 * 10.2 * 10.0 → 10.4 * 10.4 *
 beste Teiler 32.8 (14.) 53.3 (12.) 85.0 (15.)
 Trefferlage 0.57 mm rechts, 0.63 mm hoch
 Streuwert 0.88, horizontal: 1.14, vertikal: 0.51

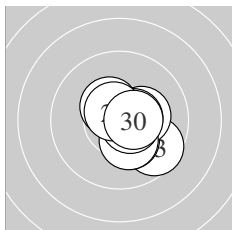

Serie 3:
 10.4 * 10.8 * 9.6 ↘ 10.3 * 10.3 *
 10.3 * 10.5 * 10.6 * 10.6 * 10.5 *
 beste Teiler 50.0 (22.) 79.8 (29.) 86.0 (28.)
 Trefferlage 0.79 mm rechts, 0.31 mm tief
 Streuwert 0.99, horizontal: 0.97, vertikal: 1.02

Unterschrift des Schützen

Ergebnis: **311.7** (295)
 Serien: 106.5 101.9 103.3
 Zähler: 25 5 0 0 0 0 0 0 0 0
 Innenzehner: 25
 weiteste: 390 (14), 364 (20), 284 (23)
 beste Teiler 14.0 (1.) 19.4 (4.) 23.4 (13.)
 Trefferlage 0.17 mm links, 0.35 mm hoch
 Streuwert 1.18, horizontal: 1.48, vertikal: 0.76

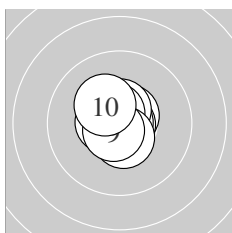
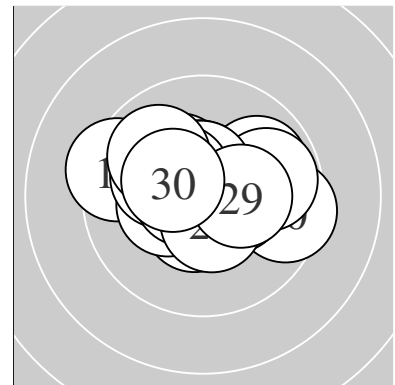

Serie 1:
 10.9 * 10.6 * 10.8 * 10.9 * 10.6 *
 10.6 * 10.6 * 10.5 * 10.7 * 10.3 *
 beste Teiler 14.0 (1.) 19.4 (4.) 37.3 (3.)
 Trefferlage 0.13 mm links, 0.21 mm hoch
 Streuwert 0.64, horizontal: 0.57, vertikal: 0.70

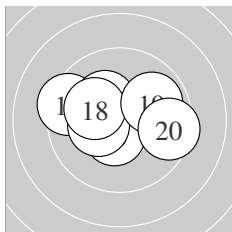

Serie 2:
 10.7 * 10.2 * 10.9 * 9.4 ← 10.5 *
 10.3 * 10.3 * 10.2 * 9.9 → 9.5 →
 beste Teiler 23.4 (13.) 55.9 (11.) 113.2 (15.)
 Trefferlage 0.45 mm links, 0.36 mm hoch
 Streuwert 1.61, horizontal: 2.11, vertikal: 0.84

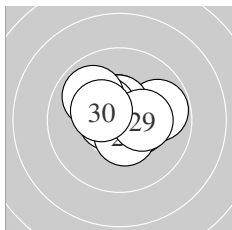

Serie 3:
 10.6 * 10.5 * 9.8 → 10.5 * 10.4 *
 10.4 * 10.5 * 9.9 ↖ 10.3 * 10.4 *
 beste Teiler 78.1 (21.) 103.3 (24.) 106.3 (22.)
 Trefferlage 0.07 mm rechts, 0.47 mm hoch
 Streuwert 1.18, horizontal: 1.46, vertikal: 0.80

Unterschrift des Schützen

Ergebnis: **306.5** (292)
 Serien: 101.7 104.3 100.5
 Zähler: 22 8 0 0 0 0 0 0 0 0
 Innenzehner: 17
 weiteste: 392 (2), 359 (29), 285 (26)
 beste Teiler 33.1 (3.) 41.9 (11.) 65.9 (16.)
 Trefferlage 0.14 mm rechts, 0.05 mm hoch
 Streuwert 1.45, horizontal: 1.50, vertikal: 1.40

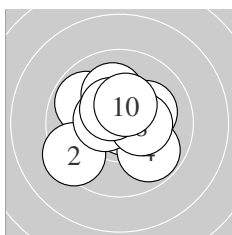
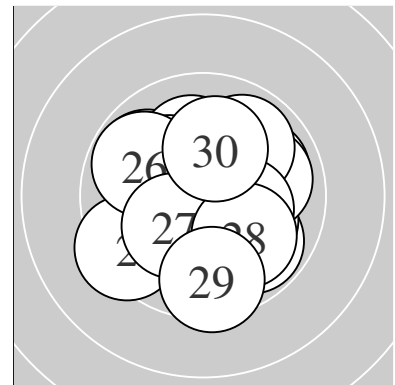

Serie 1:
 9.8 ↘ 9.4 ↙ 10.8 * 9.8 ↘ 10.1 ↑
 10.1 → 10.5 * 10.3 * 10.5 * 10.4 *
 beste Teiler 33.1 (3.) 108.4 (7.) 116.6 (9.)
 Trefferlage 0.15 mm links, 0.25 mm hoch
 Streuwert 1.59, horizontal: 1.76, vertikal: 1.40

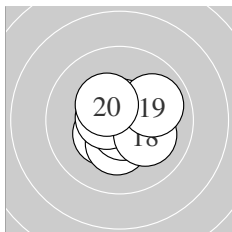

Serie 2:
 10.8 * 10.4 * 10.4 * 10.3 * 10.7 *
 10.7 * 10.6 * 10.1 ↘ 9.9 → 10.4 *
 beste Teiler 41.9 (11.) 65.9 (16.) 69.6 (15.)
 Trefferlage 0.27 mm rechts, 0.02 mm tief
 Streuwert 1.07, horizontal: 1.17, vertikal: 0.97

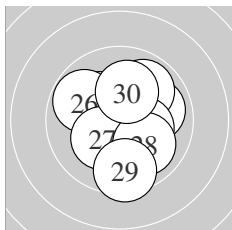

Serie 3:
 10.6 * 9.9 → 9.9 ↗ 10.3 * 10.2 *
 9.8 ↘ 10.2 * 10.0 ↘ 9.5 ↓ 10.1 ↑
 beste Teiler 79.1 (21.) 172.6 (24.) 177.5 (27.)
 Trefferlage 0.32 mm rechts, 0.05 mm tief
 Streuwert 1.73, horizontal: 1.62, vertikal: 1.83

Unterschrift des Schützen

Meyton Elektronik

Ergebnis: **307.5** (294)
 Serien: 102.3 103.8 101.4
 Zähler: 24 6 0 0 0 0 0 0 0 0
 Innenzehner: 19
 weiteste: 354 (14), 350 (30), 300 (1)
 beste Teiler 28.0 (2.) 40.4 (12.) 47.8 (19.)
 Trefferlage 0.25 mm rechts, 0.16 mm tief
 Streuwert 1.40, horizontal: 1.49, vertikal: 1.31

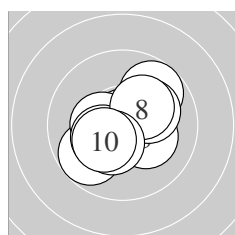
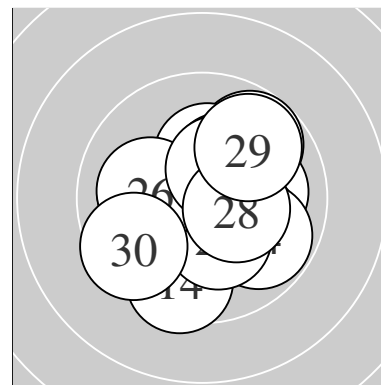

Serie 1:
 9.8 ↗ 10.8 * 9.8 ↙ 10.4 * 10.2 *
 10.3 * 10.1 ↘ 10.2 * 10.4 * 10.3 *
 beste Teiler 28.0 (2.) 141.6 (9.) 143.1 (4.)
 Trefferlage 0.02 mm links, 0.10 mm tief
 Streuwert 1.46, horizontal: 1.60, vertikal: 1.30

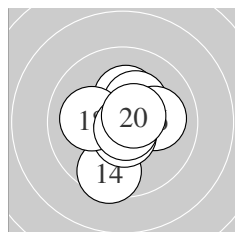

Serie 2:
 10.7 * 10.8 * 10.3 * 9.5 ↓ 10.3 *
 10.1 → 10.6 * 10.1 ← 10.8 * 10.6 *
 beste Teiler 40.4 (12.) 47.8 (19.) 62.1 (11.)
 Trefferlage 0.17 mm rechts, 0.02 mm hoch
 Streuwert 1.29, horizontal: 1.14, vertikal: 1.42

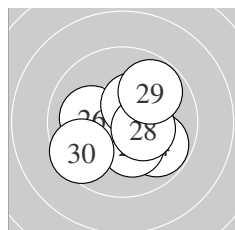

Serie 3:
 10.1 ↘ 10.5 * 10.4 * 9.8 ↘ 10.3 *
 10.1 ← 10.4 * 10.4 * 9.8 ↗ 9.6 ↙
 beste Teiler 120.3 (22.) 140.8 (27.) 144.8 (23.)
 Trefferlage 0.62 mm rechts, 0.40 mm tief
 Streuwert 1.54, horizontal: 1.74, vertikal: 1.31

Unterschrift des Schützen

Ergebnis: **306.5** (294)
 Serien: 100.1 104.4 102.0
 Zähler: 24 6 0 0 0 0 0 0 0 0
 Innenzehner: 17
 weiteste: 375 (4), 332 (1), 281 (29)
 beste Teiler 11.0 (18.) 36.1 (25.) 71.4 (15.)
 Trefferlage 0.24 mm rechts, 0.14 mm hoch
 Streuwert 1.43, horizontal: 1.33, vertikal: 1.52

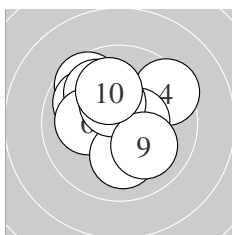
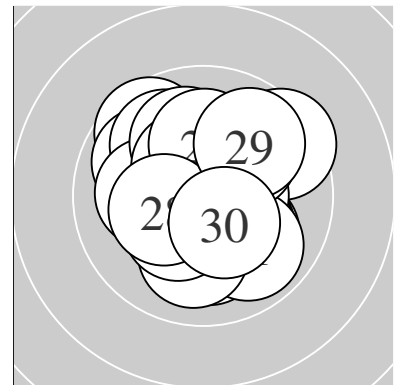

Serie 1:
 9.6 ↘ 9.9 ↘ 9.9 ↘ 9.5 ↗ 10.5 *
 10.1 ← 10.1 ↓ 10.4 * 10.1 ↘ 10.0 ↑
 beste Teiler 113.8 (5.) 141.3 (8.) 212.3 (6.)
 Trefferlage 0.30 mm links, 0.81 mm hoch
 Streuwert 1.73, horizontal: 1.83, vertikal: 1.62

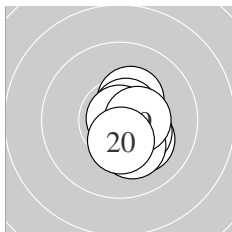

Serie 2:
 10.5 * 10.3 * 10.2 * 10.3 * 10.7 *
 10.4 * 10.2 * 10.9 * 10.5 * 10.4 *
 beste Teiler 11.0 (18.) 71.4 (15.) 121.0 (19.)
 Trefferlage 0.78 mm rechts, 0.34 mm tief
 Streuwert 0.85, horizontal: 0.49, vertikal: 1.10

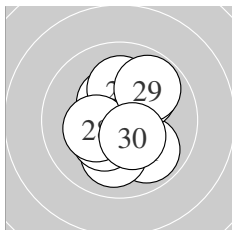

Serie 3:
 9.9 ↘ 10.0 ↗ 10.0 ↓ 10.4 * 10.8 *
 10.1 ↑ 10.3 * 10.3 * 9.8 ↗ 10.4 *
 beste Teiler 36.1 (25.) 134.7 (24.) 138.0 (30.)
 Trefferlage 0.25 mm rechts, 0.03 mm tief
 Streuwert 1.46, horizontal: 1.22, vertikal: 1.67

Unterschrift des Schützen

Ergebnis: **300.7** (286)
 Serien: 98.6 99.3 102.8
 Zähler: 16 14 0 0 0 0 0 0 0 0
 Innenzehner: 13
 weiteste: 479 (2), 442 (11), 397 (13)
 beste Teiler 36.6 (28.) 40.4 (18.) 85.4 (27.)
 Trefferlage 0.54 mm links, 0.53 mm tief
 Streuwert 1.79, horizontal: 2.00, vertikal: 1.55

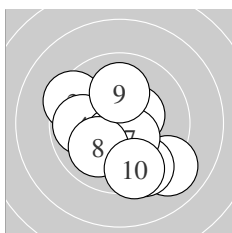
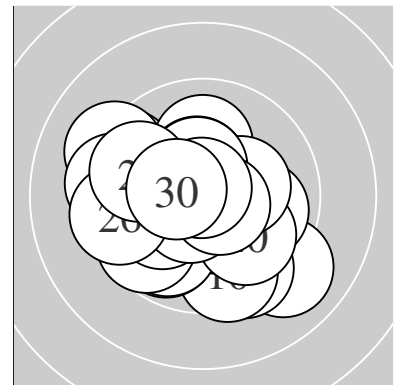

Serie 1:
 10.4 * 9.0 ↘ 9.4 ↖ 9.9 ← 10.5 *
 9.5 ↘ 10.4 * 10.0 ↗ 10.0 ↑ 9.5 ↓
 beste Teiler 113.2 (5.) 127.4 (1.) 132.0 (7.)
 Trefferlage 0.01 mm rechts, 0.93 mm tief
 Streuwert 2.09, horizontal: 2.15, vertikal: 2.03

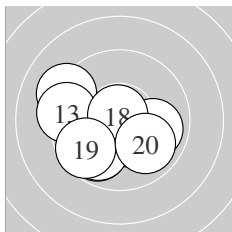

Serie 2:
 9.2 ↖ 9.9 → 9.4 ← 10.4 * 10.4 *
 9.8 ↗ 9.9 ↙ 10.8 * 9.6 ↘ 9.9 ↘
 beste Teiler 40.4 (18.) 126.7 (15.) 141.4 (14.)
 Trefferlage 0.82 mm links, 0.84 mm tief
 Streuwert 1.90, horizontal: 2.28, vertikal: 1.42

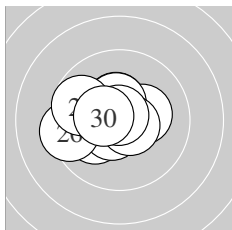

Serie 3:
 10.4 * 10.1 ↗ 10.6 * 10.3 * 10.4 *
 9.4 ← 10.6 * 10.8 * 9.7 ↖ 10.5 *
 beste Teiler 36.6 (28.) 85.4 (27.) 94.2 (23.)
 Trefferlage 0.83 mm links, 0.17 mm hoch
 Streuwert 1.31, horizontal: 1.62, vertikal: 0.89

Unterschrift des Schützen

Ergebnis: **307.7** (295)
 Serien: 103.3 101.9 102.5
 Zähler: 25 5 0 0 0 0 0 0 0 0
 Innenzehner: 21
 weiteste: 333 (15), 330 (23), 311 (21)
 beste Teiler 45.2 (3.) 50.0 (13.) 68.7 (28.)
 Trefferlage 0.35 mm links, 0.14 mm hoch
 Streuwert 1.33, horizontal: 1.51, vertikal: 1.14

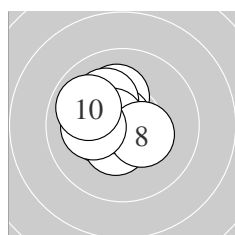
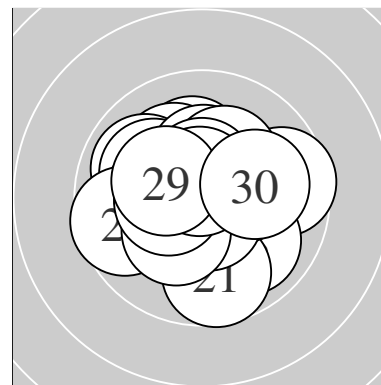

Serie 1:
 10.3 * 10.2 * 10.8 * 10.1 ↘ 10.4 *
 10.6 * 10.4 * 10.4 * 10.2 * 9.9 ↙
 beste Teiler 45.2 (3.) 78.5 (6.) 127.9 (7.)
 Trefferlage 0.80 mm links, 0.47 mm hoch
 Streuwert 1.05, horizontal: 1.02, vertikal: 1.08

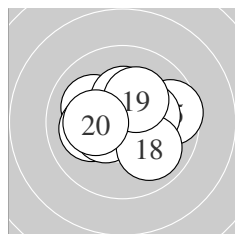

Serie 2:
 10.1 ↖ 10.1 ← 10.8 * 10.4 * 9.6 →
 10.3 * 10.3 * 9.9 ↘ 10.2 * 10.2 *
 beste Teiler 50.0 (13.) 127.9 (14.) 158.1 (16.)
 Trefferlage 0.01 mm rechts, 0.23 mm hoch
 Streuwert 1.50, horizontal: 1.86, vertikal: 1.03

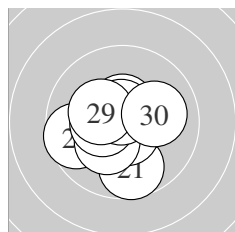

Serie 3:
 9.7 ↓ 10.3 * 9.6 ← 10.5 * 10.6 *
 10.3 * 10.4 * 10.7 * 10.3 * 10.1 →
 beste Teiler 68.7 (28.) 78.4 (25.) 104.0 (24.)
 Trefferlage 0.26 mm links, 0.28 mm tief
 Streuwert 1.42, horizontal: 1.56, vertikal: 1.26

Unterschrift des Schützen

Meyton Elektronik

Ergebnis: **283.2** (271)
 Serien: 92.0 93.9 97.3
 Zähler: 11 12 4 3 0 0 0 0 0 0
 Innenzehner: 9
 weiteste: 838 (6), 813 (1), 768 (13)
 beste Teiler 53.0 (16.) 86.6 (22.) 92.1 (27.)
 Trefferlage 1.35 mm links, 0.63 mm tief
 Streuwert 2.97, horizontal: 3.41, vertikal: 2.44

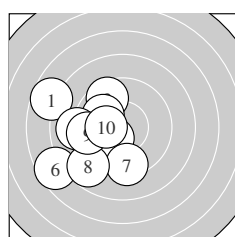
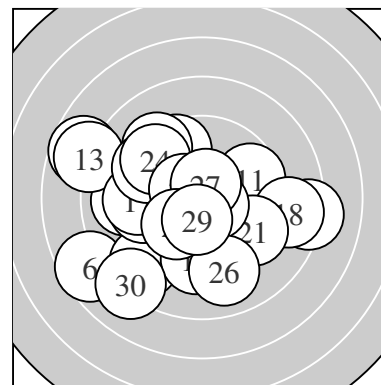

Serie 1:
 7.7 ↖ 9.6 ↗ 10.0 ↘ 10.3 * 9.0 ←
 7.6 ↙ 9.4 ↓ 8.7 ↕ 9.4 ← 10.3 *
 beste Teiler 155.2 (4.) 175.0 (10.) 242.1 (3.)
 Trefferlage 3.29 mm links, 0.71 mm tief
 Streuwert 2.69, horizontal: 2.62, vertikal: 2.76

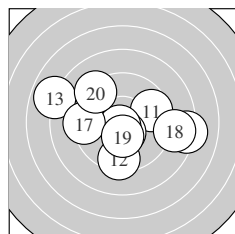

Serie 2:
 9.6 → 9.4 ↓ 7.9 ↖ 8.2 → 10.5 *
 10.7 * 9.3 ← 8.7 → 10.4 * 9.2 ↘
 beste Teiler 53.0 (16.) 112.3 (15.) 150.0 (19.)
 Trefferlage 0.07 mm rechts, 0.19 mm tief
 Streuwert 3.36, horizontal: 4.27, vertikal: 2.09

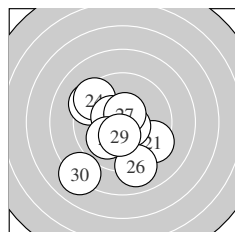

Serie 3:
 9.4 ↘ 10.6 * 9.4 ↖ 9.4 ↖ 10.4 *
 9.0 ↓ 10.6 * 10.0 ↕ 10.4 * 8.1 ↙
 beste Teiler 86.6 (22.) 92.1 (27.) 127.4 (25.)
 Trefferlage 0.85 mm links, 0.98 mm tief
 Streuwert 2.51, horizontal: 2.40, vertikal: 2.62

Unterschrift des Schützen

Ergebnis: **292.4** (276)
 Serien: 93.2 99.6 99.6
 Zähler: 12 13 4 1 0 0 0 0 0 0
 Innenzehner: 9
 weiteste: 775 (9), 651 (8), 646 (10)
 beste Teiler 35.6 (26.) 59.9 (23.) 88.0 (19.)
 Trefferlage 0.62 mm links, 2.13 mm hoch
 Streuwert 1.96, horizontal: 2.04, vertikal: 1.89

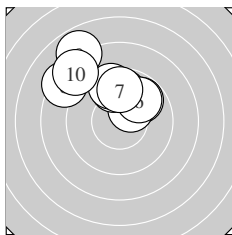
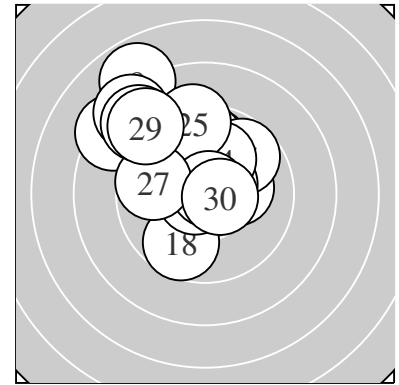

Serie 1:
 9.8 ↗ 9.8 ↑ 10.3 * 9.7 ↑ 9.5 ↑
 9.8 ↗ 9.7 ↑ 8.3 ↘ 7.9 ↘ 8.4 ↘
 beste Teiler 159.9 (3.) 282.4 (6.) 284.6 (2.)
 Trefferlage 0.97 mm links, 3.28 mm hoch
 Streuwert 2.19, horizontal: 2.69, vertikal: 1.54

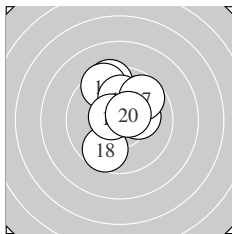

Serie 2:
 10.2 * 9.9 ↗ 10.0 ↑ 9.4 ↑ 9.5 ↘
 10.1 ↑ 9.7 ↗ 9.7 ↓ 10.6 * 10.5 *
 beste Teiler 88.0 (19.) 102.3 (20.) 185.7 (11.)
 Trefferlage 0.17 mm rechts, 1.43 mm hoch
 Streuwert 1.66, horizontal: 1.37, vertikal: 1.91

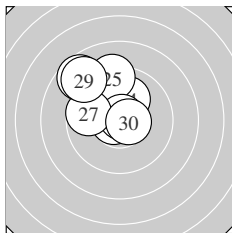

Serie 3:
 10.4 * 10.6 * 10.7 * 10.1 ↗ 9.2 ↑
 10.8 * 9.7 ← 8.7 ↘ 8.8 ↘ 10.6 *
 beste Teiler 35.6 (26.) 59.9 (23.) 89.2 (22.)
 Trefferlage 1.06 mm links, 1.69 mm hoch
 Streuwert 1.79, horizontal: 1.79, vertikal: 1.79

Unterschrift des Schützen

Ergebnis: **295.1** (281)
 Serien: 96.9 100.9 97.3
 Zähler: 15 11 4 0 0 0 0 0 0 0
 Innenzehner: 10
 weiteste: 612 (26), 600 (1), 588 (7)
 beste Teiler 66.3 (13.) 73.0 (10.) 106.9 (21.)
 Trefferlage 0.31 mm links, 0.55 mm tief
 Streuwert 2.25, horizontal: 2.34, vertikal: 2.16

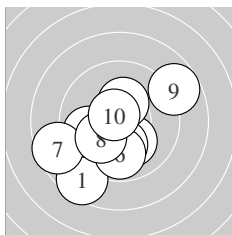
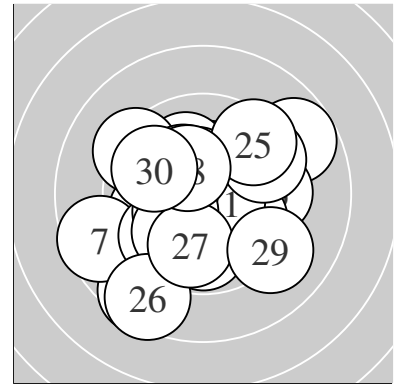

Serie 1:
 8.6 ↙ 10.1 ↘ 9.8 ← 10.1 ↓ 10.3 *
 9.8 ↓ 8.6 ← 10.1 ↗ 8.8 ↗ 10.7 *
 beste Teiler 73.0 (10.) 161.0 (5.) 202.2 (2.)
 Trefferlage 0.71 mm links, 1.14 mm tief
 Streuwert 2.52, horizontal: 2.76, vertikal: 2.27

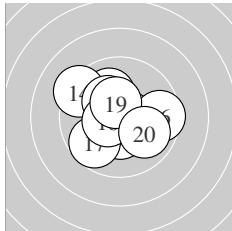

Serie 2:
 10.1 ↖ 10.4 * 10.7 * 9.3 ↖ 10.3 *
 9.6 → 9.7 ↙ 10.5 * 10.4 * 9.9 ↘
 beste Teiler 66.3 (13.) 108.4 (18.) 130.2 (19.)
 Trefferlage 0.26 mm links, 0.18 mm hoch
 Streuwert 1.79, horizontal: 2.02, vertikal: 1.53

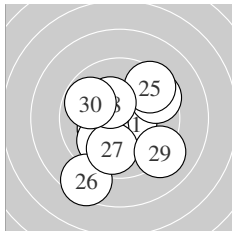

Serie 3:
 10.5 * 10.3 * 9.5 ↗ 10.0 ↙ 9.4 ↗
 8.5 ↙ 9.9 ↓ 10.3 * 9.1 ↘ 9.8 ↖
 beste Teiler 106.9 (21.) 157.4 (28.) 172.2 (22.)
 Trefferlage 0.04 mm rechts, 0.70 mm tief
 Streuwert 2.46, horizontal: 2.37, vertikal: 2.55

Unterschrift des Schützen

Ergebnis: **303.3** (291)
 Serien: 101.4 101.3 100.6
 Zähler: 21 9 0 0 0 0 0 0 0 0
 Innenzehner: 17
 weiteste: 369 (6), 358 (24), 335 (17)
 beste Teiler 121.0 (1.) 134.7 (30.) 137.0 (4.)
 Trefferlage 0.18 mm links, 1.03 mm hoch
 Streuwert 1.41, horizontal: 1.81, vertikal: 0.82

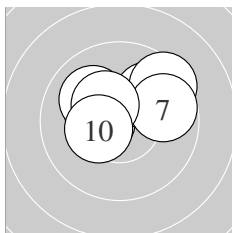
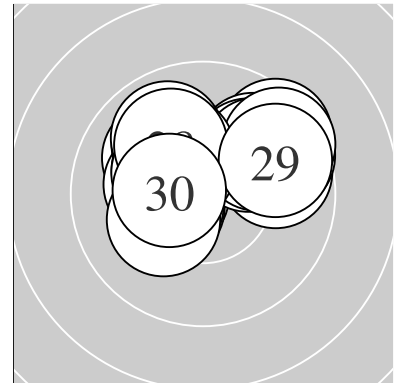

Serie 1:
 10.5 * 10.3 * 9.9 ↗ 10.4 * 10.3 *
 9.5 ↗ 9.7 → 10.0 ↘ 10.4 * 10.4 *
 beste Teiler 121.0 (1.) 137.0 (4.) 144.4 (9.)
 Trefferlage 0.15 mm links, 0.90 mm hoch
 Streuwert 1.46, horizontal: 1.89, vertikal: 0.81

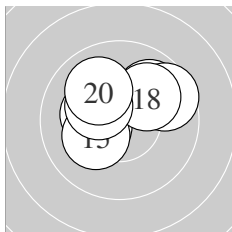

Serie 2:
 10.3 * 10.4 * 10.3 * 10.3 * 10.2 *
 9.9 ↗ 9.6 → 10.0 ↗ 10.3 * 10.0 ↘
 beste Teiler 149.3 (12.) 159.7 (11.) 159.7 (13.)
 Trefferlage 0.35 mm links, 0.80 mm hoch
 Streuwert 1.46, horizontal: 1.83, vertikal: 0.96

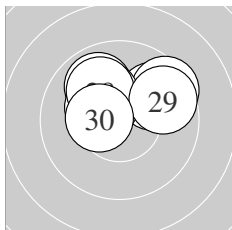

Serie 3:
 10.3 * 9.9 ↗ 9.9 ↘ 9.5 ↗ 10.3 *
 10.4 * 10.2 * 10.0 ↘ 9.7 → 10.4 *
 beste Teiler 134.7 (30.) 143.6 (26.) 154.1 (21.)
 Trefferlage 0.03 mm links, 1.39 mm hoch
 Streuwert 1.41, horizontal: 1.89, vertikal: 0.62

Unterschrift des Schützen

Ergebnis: **305.1** (291)
 Serien: 102.4 101.6 101.1
 Zähler: 21 9 0 0 0 0 0 0 0 0
 Innenzehner: 16
 weiteste: 461 (25), 350 (19), 341 (17)
 beste Teiler 41.7 (18.) 52.3 (16.) 63.0 (5.)
 Trefferlage 0.04 mm links, 0.14 mm hoch
 Streuwert 1.57, horizontal: 1.84, vertikal: 1.26

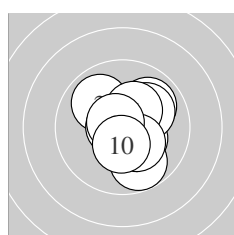
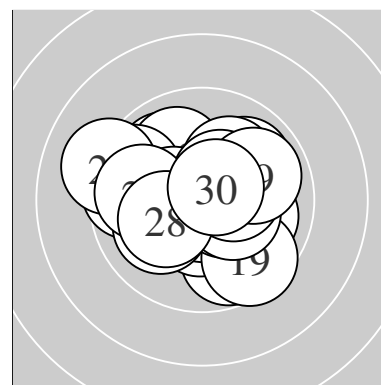

Serie 1:
 9.9 ↗ 10.3 * 9.9 ↘ 10.1 ↗ 10.7 *
 10.3 * 9.8 ↘ 10.3 * 10.7 * 10.4 *
 beste Teiler 63.0 (5.) 67.1 (9.) 133.3 (10.)
 Trefferlage 0.52 mm rechts, 0.03 mm hoch
 Streuwert 1.38, horizontal: 1.22, vertikal: 1.52

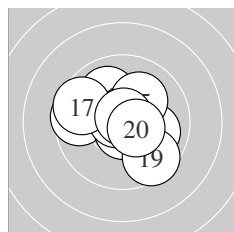

Serie 2:
 10.0 ↘ 10.0 ↘ 9.6 ← 10.7 * 10.1 ↗
 10.7 * 9.6 ← 10.8 * 9.6 ↘ 10.5 *
 beste Teiler 41.7 (18.) 52.3 (16.) 66.1 (14.)
 Trefferlage 0.12 mm links, 0.15 mm hoch
 Streuwert 1.72, horizontal: 1.99, vertikal: 1.39

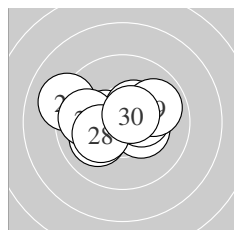

Serie 3:
 10.4 * 10.4 * 10.3 * 10.0 ↙ 9.1 ↖
 9.8 ← 10.4 * 10.2 * 9.9 ↗ 10.6 *
 beste Teiler 87.0 (30.) 133.5 (22.) 135.1 (21.)
 Trefferlage 0.52 mm links, 0.25 mm hoch
 Streuwert 1.68, horizontal: 2.19, vertikal: 0.90

Unterschrift des Schützen

Ergebnis: **307.3** (295)
 Serien: 102.1 102.4 102.8
 Zähler: 25 5 0 0 0 0 0 0 0 0
 Innenzehner: 18
 weiteste: 294 (7), 288 (18), 273 (26)
 beste Teiler 58.0 (30.) 59.2 (8.) 61.7 (4.)
 Trefferlage 0.35 mm links, 0.37 mm hoch
 Streuwert 1.32, horizontal: 1.37, vertikal: 1.28

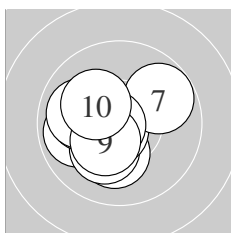
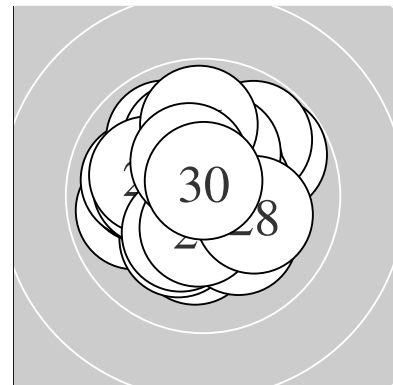

Serie 1:
 10.2 * 9.9 ← 10.2 * 10.7 * 10.0 ←
 10.0 ← 9.8 ↗ 10.7 * 10.4 * 10.2 *
 beste Teiler 59.2 (8.) 61.7 (4.) 142.7 (9.)
 Trefferlage 0.94 mm links, 0.19 mm tief
 Streuwert 1.33, horizontal: 1.48, vertikal: 1.16

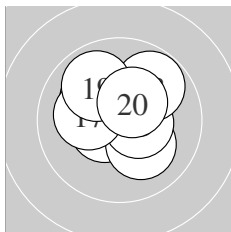

Serie 2:
 10.5 * 10.6 * 10.1 ↘ 10.3 * 10.5 *
 10.1 ↘ 10.2 * 9.8 ↗ 9.9 ↘ 10.4 *
 beste Teiler 77.2 (12.) 105.1 (11.) 121.4 (15.)
 Trefferlage 0.03 mm links, 0.71 mm hoch
 Streuwert 1.29, horizontal: 1.39, vertikal: 1.18

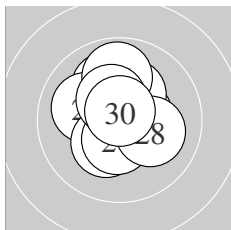

Serie 3:
 10.1 ↖ 10.1 ← 10.5 * 10.2 * 10.3 *
 9.9 ↑ 10.5 * 10.1 → 10.4 * 10.7 *
 beste Teiler 58.0 (30.) 116.4 (23.) 123.3 (27.)
 Trefferlage 0.08 mm links, 0.60 mm hoch
 Streuwert 1.27, horizontal: 1.14, vertikal: 1.40

Unterschrift des Schützen

Ergebnis: **294.0** (283)
 Serien: 98.3 98.4 97.3
 Zähler: 16 11 3 0 0 0 0 0 0 0
 Innenzehner: 11
 weiteste: 606 (30), 605 (28), 554 (21)
 beste Teiler 7.6 (26.) 73.6 (7.) 107.0 (22.)
 Trefferlage 0.82 mm links, 1.54 mm hoch
 Streuwert 1.99, horizontal: 2.49, vertikal: 1.31

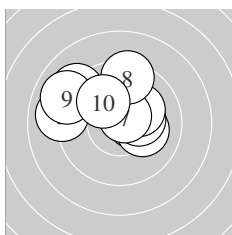
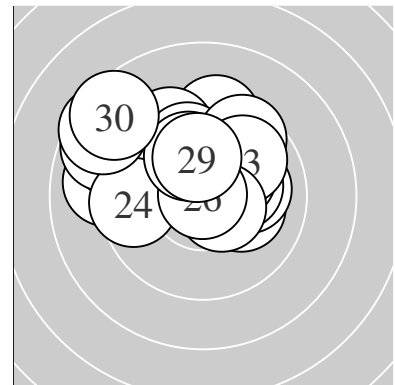

Serie 1:
 10.5 * 10.1 → 9.0 ← 10.3 * 9.1 ↘
 10.2 * 10.7 * 9.4 ↑ 9.0 ↖ 10.0 ↘
 beste Teiler 73.6 (7.) 121.1 (1.) 167.0 (4.)
 Trefferlage 0.67 mm links, 1.28 mm hoch
 Streuwert 2.12, horizontal: 2.67, vertikal: 1.36

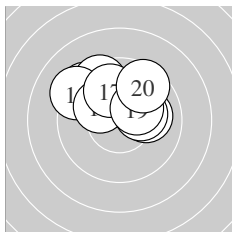

Serie 2:
 9.4 ↘ 10.1 → 9.5 ↖ 9.2 ↖ 10.2 *
 10.1 ↘ 9.9 ↖ 10.2 * 10.2 * 9.6 ↗
 beste Teiler 176.1 (19.) 187.0 (18.) 188.6 (15.)
 Trefferlage 0.27 mm links, 1.83 mm hoch
 Streuwert 1.67, horizontal: 2.13, vertikal: 1.02

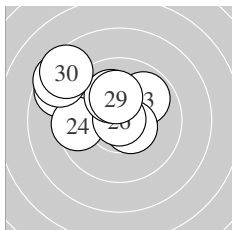

Serie 3:
 8.7 ↘ 10.5 * 9.9 ↗ 9.5 ← 10.5 *
 10.9 * 10.1 ↖ 8.5 ↖ 10.2 * 8.5 ↘
 beste Teiler 7.6 (26.) 107.0 (22.) 109.9 (25.)
 Trefferlage 1.51 mm links, 1.52 mm hoch
 Streuwert 2.22, horizontal: 2.71, vertikal: 1.57

Unterschrift des Schützen

Ergebnis: **300.5** (285)
 Serien: 99.7 99.6 101.2
 Zähler: 16 13 1 0 0 0 0 0 0 0
 Innenzehner: 11
 weiteste: 513 (15), 448 (4), 412 (11)
 beste Teiler 57.7 (29.) 71.0 (28.) 82.0 (17.)
 Trefferlage 0.07 mm links, 0.54 mm hoch
 Streuwert 1.81, horizontal: 1.82, vertikal: 1.80

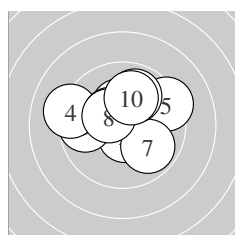
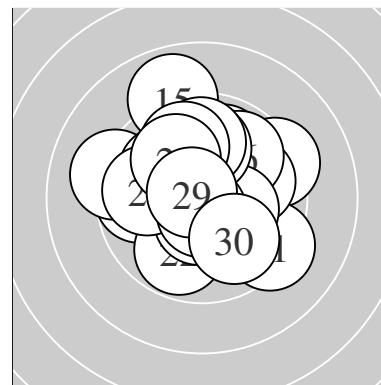

Serie 1:
 10.3 * 10.6 * 9.7 ← 9.2 ← 9.3 →
 10.4 * 9.9 ↘ 10.4 * 9.9 ↑ 10.0 ↑
 beste Teiler 86.8 (2.) 136.7 (6.) 137.3 (8.)
 Trefferlage 0.23 mm links, 0.82 mm hoch
 Streuwert 1.91, horizontal: 2.34, vertikal: 1.35

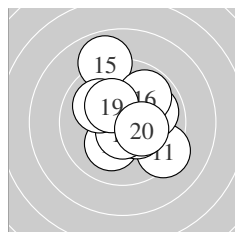

Serie 2:
 9.3 ↘ 10.1 ↙ 10.4 * 9.9 → 8.9 ↑
 9.8 ↗ 10.6 * 10.0 ↖ 10.3 * 10.3 *
 beste Teiler 82.0 (17.) 143.3 (13.) 164.4 (19.)
 Trefferlage 0.51 mm rechts, 0.42 mm hoch
 Streuwert 1.98, horizontal: 1.80, vertikal: 2.15

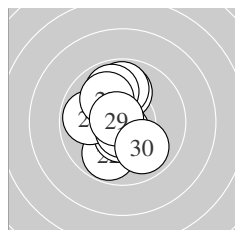

Serie 3:
 10.0 ↑ 9.8 ↙ 10.5 * 9.8 ↑ 9.9 ←
 9.9 ↑ 10.0 ↖ 10.7 * 10.7 * 9.9 ↘
 beste Teiler 57.7 (29.) 71.0 (28.) 110.1 (23.)
 Trefferlage 0.50 mm links, 0.39 mm hoch
 Streuwert 1.61, horizontal: 1.14, vertikal: 1.98

Unterschrift des Schützen

Meyton Elektronik

Ergebnis: **296.6** (282)
 Serien: 97.9 98.3 100.4
 Zähler: 14 14 2 0 0 0 0 0 0 0
 Innenzehner: 12
 weiteste: 523 (12), 507 (21), 484 (3)
 beste Teiler 83.0 (7.) 88.2 (16.) 92.7 (30.)
 Trefferlage 1.48 mm links, 0.15 mm hoch
 Streuwert 1.83, horizontal: 1.87, vertikal: 1.79

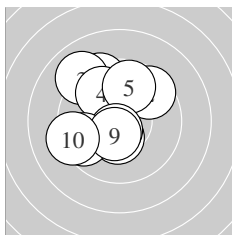
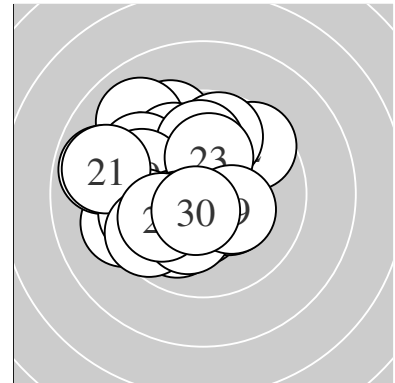

Serie 1:
 9.4 ↘ 9.6 ↗ 9.0 ↘ 9.8 ↘ 9.7 ↑
 10.4 * 10.6 * 9.6 ↙ 10.5 * 9.3 ←
 beste Teiler 83.0 (7.) 117.1 (9.) 139.9 (6.)
 Trefferlage 1.09 mm links, 0.86 mm hoch
 Streuwert 2.13, horizontal: 1.98, vertikal: 2.27

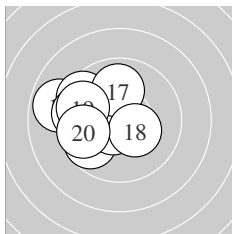

Serie 2:
 10.6 * 8.9 ← 9.5 ↘ 9.5 ← 9.7 ↙
 10.6 * 9.9 ↑ 10.3 * 9.6 ↘ 9.7 ←
 beste Teiler 88.2 (16.) 99.6 (11.) 155.8 (18.)
 Trefferlage 2.05 mm links, 0.34 mm hoch
 Streuwert 1.69, horizontal: 1.93, vertikal: 1.40

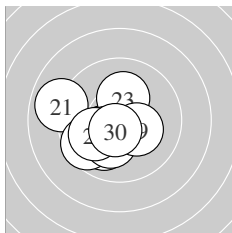

Serie 3:
 8.9 ← 10.3 * 10.2 * 10.0 ↙ 10.3 *
 9.6 ↙ 10.2 * 10.0 ↙ 10.3 * 10.6 *
 beste Teiler 92.7 (30.) 162.7 (25.) 165.1 (29.)
 Trefferlage 1.30 mm links, 0.76 mm tief
 Streuwert 1.54, horizontal: 1.73, vertikal: 1.31

Unterschrift des Schützen

Ergebnis: **309.1** (295)
 Serien: 103.9 103.3 101.9
 Zähler: 25 5 0 0 0 0 0 0 0 0
 Innenzehner: 24
 weiteste: 365 (29), 336 (27), 323 (14)
 beste Teiler 46.0 (4.) 63.9 (26.) 67.1 (18.)
 Trefferlage 0.24 mm rechts, 0.51 mm tief
 Streuwert 1.26, horizontal: 1.43, vertikal: 1.07

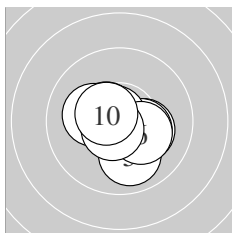
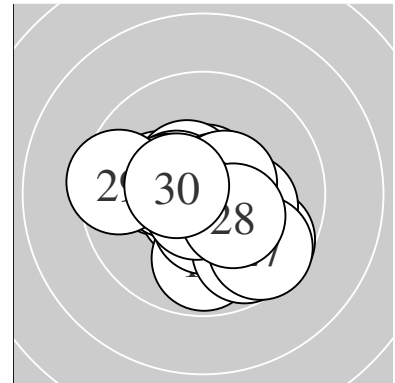

Serie 1:
 10.2 * 10.5 * 10.3 * 10.8 * 10.0 ↘
 10.3 * 10.5 * 10.2 * 10.6 * 10.5 *
 beste Teiler 46.0 (4.) 76.4 (9.) 108.7 (10.)
 Trefferlage 0.03 mm links, 0.28 mm tief
 Streuwert 1.12, horizontal: 1.29, vertikal: 0.92

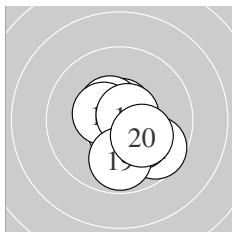

Serie 2:
 10.7 * 10.7 * 10.5 * 9.7 ↘ 10.5 *
 10.2 * 10.3 * 10.7 * 9.8 ↓ 10.2 *
 beste Teiler 67.1 (18.) 71.4 (11.) 74.6 (12.)
 Trefferlage 0.56 mm rechts, 0.63 mm tief
 Streuwert 1.19, horizontal: 1.14, vertikal: 1.23

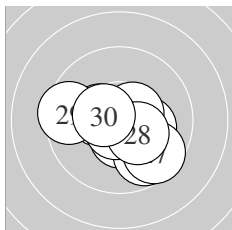

Serie 3:
 10.2 * 10.4 * 10.5 * 10.5 * 9.7 ↘
 10.7 * 9.6 ↘ 10.3 * 9.5 ← 10.5 *
 beste Teiler 63.9 (26.) 104.2 (23.) 118.2 (30.)
 Trefferlage 0.19 mm rechts, 0.63 mm tief
 Streuwert 1.53, horizontal: 1.86, vertikal: 1.10

Unterschrift des Schützen

Ergebnis: **310.4** (299)
 Serien: 103.9 103.8 102.7
 Zähler: 29 1 0 0 0 0 0 0 0 0
 Innenzehner: 24
 weiteste: 297 (20), 246 (21), 241 (7)
 beste Teiler 41.1 (16.) 53.0 (14.) 65.1 (10.)
 Trefferlage 0.38 mm links, 0.21 mm hoch
 Streuwert 1.14, horizontal: 1.33, vertikal: 0.91

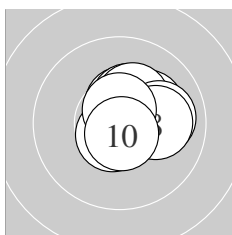
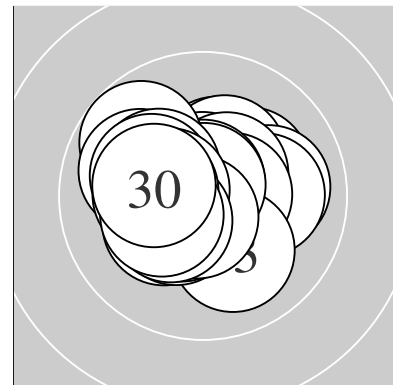

Serie 1:
 10.6 * 10.5 * 10.2 * 10.5 * 10.4 *
 10.3 * 10.0 → 10.1 → 10.6 * 10.7 *
 beste Teiler 65.1 (10.) 81.0 (9.) 82.1 (1.)
 Trefferlage 0.79 mm rechts, 0.58 mm hoch
 Streuwert 0.88, horizontal: 0.97, vertikal: 0.79

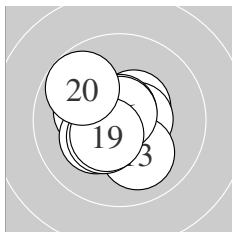

Serie 2:
 10.5 * 10.6 * 10.0 ↘ 10.7 * 10.2 *
 10.8 * 10.3 * 10.4 * 10.5 * 9.8 ↙
 beste Teiler 41.1 (16.) 53.0 (14.) 100.1 (12.)
 Trefferlage 0.42 mm links, 0.06 mm tief
 Streuwert 1.17, horizontal: 1.20, vertikal: 1.14

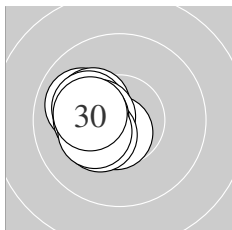

Serie 3:
 10.0 ↖ 10.2 * 10.6 * 10.1 ↖ 10.4 *
 10.2 * 10.4 * 10.3 * 10.3 * 10.2 *
 beste Teiler 79.4 (23.) 130.0 (25.) 148.4 (27.)
 Trefferlage 1.52 mm links, 0.10 mm hoch
 Streuwert 0.62, horizontal: 0.55, vertikal: 0.69

Unterschrift des Schützen

Ergebnis: **314.1** (299)
 Serien: 104.7 103.7 105.7
 Zähler: 29 1 0 0 0 0 0 0 0 0
 Innenzehner: 25
 weiteste: 334 (12), 229 (17), 217 (8)
 beste Teiler 10.0 (28.) 34.1 (11.) 36.7 (25.)
 Trefferlage 0.08 mm rechts, 0.21 mm hoch
 Streuwert 1.00, horizontal: 0.87, vertikal: 1.11

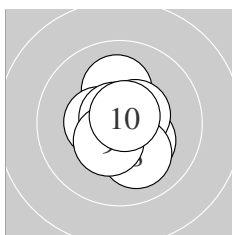
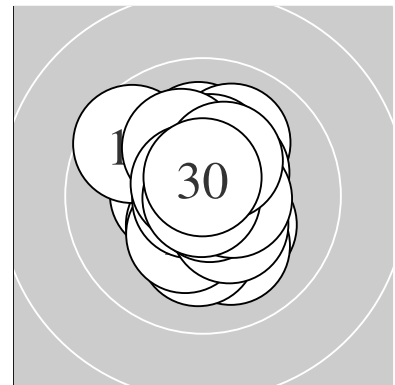

Serie 1:
 10.7 * 10.7 * 10.1 ↑ 10.3 * 10.4 *
 10.8 * 10.5 * 10.1 ↘ 10.4 * 10.7 *
 beste Teiler 48.7 (6.) 55.0 (1.) 55.2 (10.)
 Trefferlage 0.05 mm rechts, 0.03 mm hoch
 Streuwert 1.00, horizontal: 0.84, vertikal: 1.13

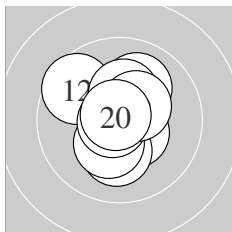

Serie 2:
 10.8 * 9.6 ↖ 10.5 * 10.2 * 10.3 *
 10.8 * 10.0 ↗ 10.3 * 10.4 * 10.8 *
 beste Teiler 34.1 (11.) 40.6 (20.) 46.8 (16.)
 Trefferlage 0.06 mm links, 0.25 mm hoch
 Streuwert 1.26, horizontal: 1.12, vertikal: 1.39

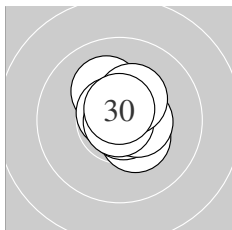

Serie 3:
 10.7 * 10.6 * 10.4 * 10.1 ↖ 10.8 *
 10.7 * 10.5 * 10.9 * 10.3 * 10.7 *
 beste Teiler 10.0 (28.) 36.7 (25.) 58.9 (21.)
 Trefferlage 0.26 mm rechts, 0.36 mm hoch
 Streuwert 0.75, horizontal: 0.65, vertikal: 0.83

Unterschrift des Schützen

Ergebnis: **314.1** (299)
 Serien: 104.8 104.5 104.8
 Zähler: 29 1 0 0 0 0 0 0 0 0
 Innenzehner: 26
 weiteste: 305 (13), 250 (6), 225 (23)
 beste Teiler 8.0 (14.) 45.5 (24.) 55.3 (11.)
 Trefferlage 0.09 mm links, 0.06 mm tief
 Streuwert 0.99, horizontal: 0.98, vertikal: 1.01

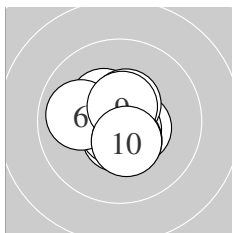
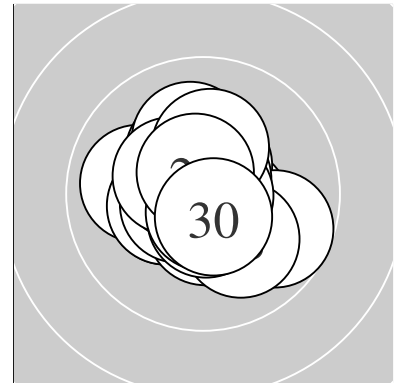

Serie 1:
 10.5 * 10.7 * 10.4 * 10.6 * 10.7 *
 10.0 ← 10.5 * 10.4 * 10.6 * 10.4 *
 beste Teiler 61.2 (5.) 68.2 (2.) 95.5 (9.)
 Trefferlage 0.09 mm links, 0.14 mm tief
 Streuwert 0.98, horizontal: 1.00, vertikal: 0.95

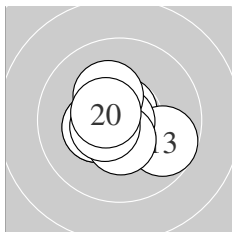

Serie 2:
 10.7 * 10.6 * 9.7 ↘ 10.9 * 10.4 *
 10.3 * 10.5 * 10.3 * 10.5 * 10.6 *
 beste Teiler 8.0 (14.) 55.3 (11.) 87.2 (12.)
 Trefferlage 0.31 mm links, 0.19 mm tief
 Streuwert 1.06, horizontal: 1.22, vertikal: 0.87

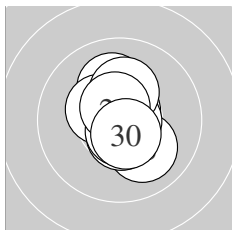

Serie 3:
 10.7 * 10.1 ↑ 10.1 ↘ 10.8 * 10.4 *
 10.2 * 10.6 * 10.7 * 10.6 * 10.6 *
 beste Teiler 45.5 (24.) 67.9 (21.) 70.1 (28.)
 Trefferlage 0.11 mm rechts, 0.15 mm hoch
 Streuwert 1.01, horizontal: 0.70, vertikal: 1.24

Unterschrift des Schützen

Ergebnis: **292.7** (279)
 Serien: 101.8 94.4 96.5
 Zähler: 16 9 3 2 0 0 0 0 0 0
 Innenzehner: 14
 weiteste: 830 (14), 767 (23), 743 (12)
 beste Teiler 6.7 (2.) 24.4 (27.) 44.5 (20.)
 Trefferlage 1.05 mm links, 0.29 mm hoch
 Streuwert 2.55, horizontal: 3.40, vertikal: 1.22

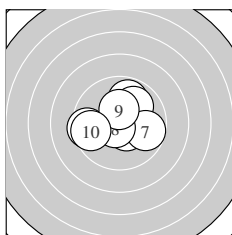
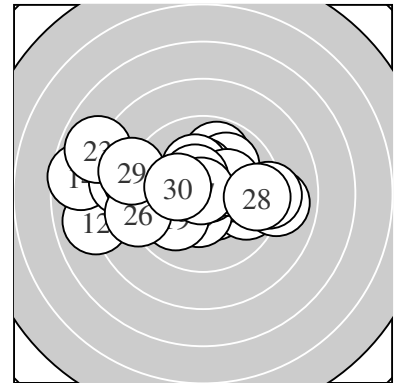

Serie 1:
 9.8 ↗ 10.9 * 10.8 * 9.5 ← 10.0 ↗
 10.5 * 9.7 → 10.7 * 10.3 * 9.6 ←
 beste Teiler 6.7 (2.) 50.1 (3.) 70.0 (8.)
 Trefferlage 0.09 mm links, 0.22 mm hoch
 Streuwert 1.69, horizontal: 2.01, vertikal: 1.29

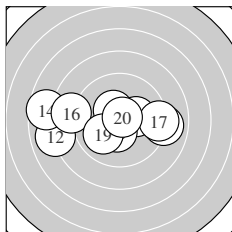

Serie 2:
 10.2 * 8.0 ← 9.0 → 7.6 ← 10.4 *
 8.8 ← 9.2 → 10.4 * 10.0 ↗ 10.8 *
 beste Teiler 44.5 (20.) 130.3 (15.) 136.1 (18.)
 Trefferlage 1.22 mm links, 0.16 mm tief
 Streuwert 3.30, horizontal: 4.54, vertikal: 1.11

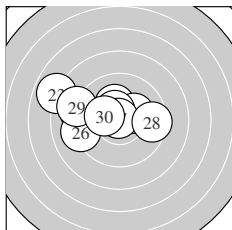

Serie 3:
 9.1 ← 10.2 * 7.9 ↖ 10.2 * 10.5 *
 9.1 ← 10.9 * 9.5 → 8.9 ↖ 10.2 *
 beste Teiler 24.4 (27.) 120.7 (25.) 177.3 (30.)
 Trefferlage 1.83 mm links, 0.82 mm hoch
 Streuwert 2.47, horizontal: 3.29, vertikal: 1.16

Unterschrift des Schützen

Ergebnis: **308.4** (294)
 Serien: 104.3 102.0 102.1
 Zähler: 24 6 0 0 0 0 0 0 0 0
 Innenzehner: 21
 weiteste: 398 (20), 347 (17), 298 (23)
 beste Teiler 36.6 (6.) 63.2 (15.) 66.0 (9.)
 Trefferlage 0.30 mm links, 1.03 mm tief
 Streuwert 1.13, horizontal: 1.25, vertikal: 1.00

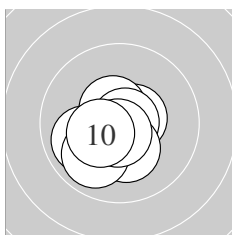
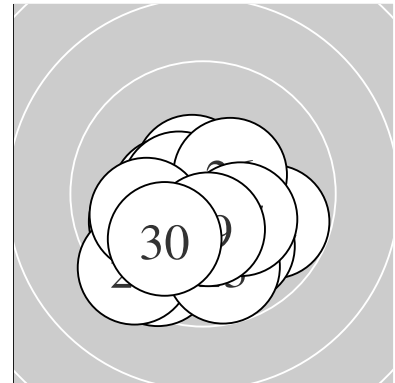

Serie 1:
 10.6 * 10.6 * 10.5 * 10.6 * 9.9 ↙
 10.8 * 10.3 * 9.9 ↘ 10.7 * 10.4 *
 beste Teiler 36.6 (6.) 66.0 (9.) 78.6 (1.)
 Trefferlage 0.42 mm links, 0.64 mm tief
 Streuwert 0.95, horizontal: 1.01, vertikal: 0.89

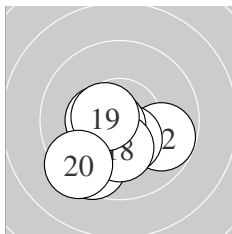

Serie 2:
 10.4 * 9.8 → 10.5 * 10.4 * 10.7 *
 10.4 * 9.6 ↘ 10.2 * 10.6 * 9.4 ↘
 beste Teiler 63.2 (15.) 98.4 (19.) 120.7 (13.)
 Trefferlage 0.53 mm links, 1.21 mm tief
 Streuwert 1.31, horizontal: 1.48, vertikal: 1.11

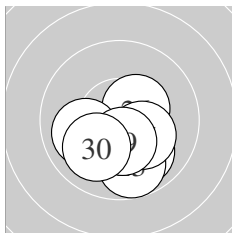

Serie 3:
 10.3 * 10.0 ↘ 9.8 ↓ 10.6 * 10.4 *
 10.4 * 10.2 * 10.0 ← 10.4 * 10.0 ↘
 beste Teiler 77.0 (24.) 127.1 (25.) 131.2 (26.)
 Trefferlage 0.04 mm rechts, 1.24 mm tief
 Streuwert 1.13, horizontal: 1.27, vertikal: 0.97

Unterschrift des Schützen

Ergebnis: **303.1** (291)
 Serien: 98.9 103.3 100.9
 Zähler: 21 9 0 0 0 0 0 0 0 0
 Innenzehner: 14
 weiteste: 470 (17), 391 (10), 353 (5)
 beste Teiler 52.8 (13.) 54.3 (15.) 74.9 (14.)
 Trefferlage 0.71 mm links, 0.45 mm hoch
 Streuwert 1.58, horizontal: 1.65, vertikal: 1.51

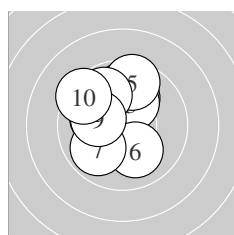
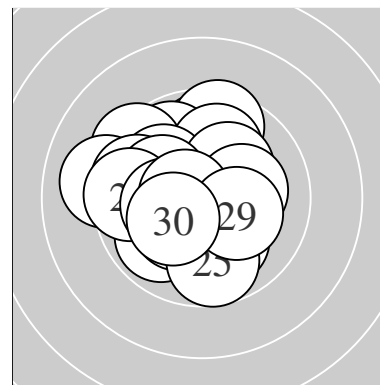

Serie 1:
 9.8 ↑ 10.0 ↗ 10.2 * 10.1 ↖ 9.5 ↑
 10.1 ↓ 9.9 ↙ 9.8 ↘ 10.1 ↖ 9.4 ↘
 beste Teiler 194.4 (3.) 203.0 (9.) 210.1 (4.)
 Trefferlage 0.73 mm links, 1.23 mm hoch
 Streuwert 1.72, horizontal: 1.54, vertikal: 1.88

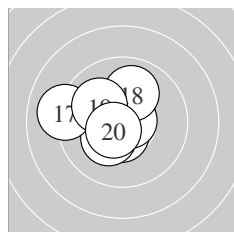

Serie 2:
 10.6 * 10.6 * 10.7 * 10.7 * 10.7 *
 10.3 * 9.1 ← 10.0 ↑ 10.0 ↘ 10.6 *
 beste Teiler 52.8 (13.) 54.3 (15.) 74.9 (14.)
 Trefferlage 0.71 mm links, 0.27 mm hoch
 Streuwert 1.37, horizontal: 1.61, vertikal: 1.08

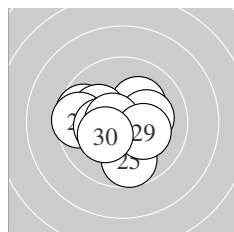

Serie 3:
 10.2 * 9.7 ↖ 10.1 ↖ 10.2 * 9.7 ↓
 9.6 ← 10.3 * 10.6 * 10.2 * 10.3 *
 beste Teiler 83.4 (28.) 173.2 (30.) 173.9 (27.)
 Trefferlage 0.71 mm links, 0.14 mm tief
 Streuwert 1.64, horizontal: 1.96, vertikal: 1.25

Unterschrift des Schützen

Meyton Elektronik

Ergebnis: **307.0** (297)
 Serien: 102.2 102.8 102.0
 Zähler: 27 3 0 0 0 0 0 0 0 0
 Innenzehner: 14
 weiteste: 424 (11), 292 (25), 284 (26)
 beste Teiler 34.5 (29.) 70.2 (14.) 76.5 (10.)
 Trefferlage 0.26 mm links, 0.86 mm hoch
 Streuwert 1.26, horizontal: 1.36, vertikal: 1.15

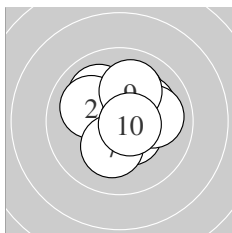
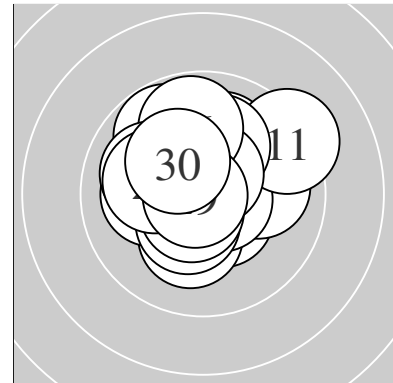

Serie 1:
 10.0 ↘ 10.1 ↖ 10.1 ↗ 10.5 * 10.6 *
 10.1 ↗ 10.2 * 10.0 → 10.0 † 10.6 *
 beste Teiler 76.5 (10.) 86.2 (5.) 119.7 (4.)
 Trefferlage 0.41 mm rechts, 0.53 mm hoch
 Streuwert 1.33, horizontal: 1.36, vertikal: 1.28

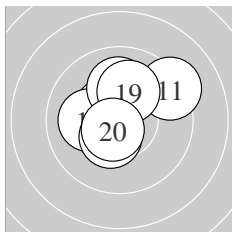

Serie 2:
 9.3 ↗ 10.6 * 10.5 * 10.7 * 10.5 *
 10.1 ← 10.0 † 10.4 * 10.1 † 10.6 *
 beste Teiler 70.2 (14.) 83.8 (20.) 90.0 (12.)
 Trefferlage 0.18 mm links, 0.75 mm hoch
 Streuwert 1.36, horizontal: 1.50, vertikal: 1.19

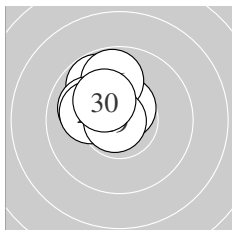

Serie 3:
 10.1 † 10.1 ↘ 10.6 * 10.5 * 9.8 ↘
 9.8 † 10.0 ↖ 10.1 ← 10.8 * 10.2 *
 beste Teiler 34.5 (29.) 92.8 (23.) 106.4 (24.)
 Trefferlage 1.03 mm links, 1.29 mm hoch
 Streuwert 0.87, horizontal: 0.81, vertikal: 0.93

Unterschrift des Schützen

Ergebnis: **308.0** (293)
 Serien: 104.1 101.2 102.7
 Zähler: 23 7 0 0 0 0 0 0 0 0
 Innenzehner: 20
 weiteste: 385 (5), 361 (30), 352 (16)
 beste Teiler 49.4 (23.) 51.6 (19.) 61.5 (9.)
 Trefferlage 0.43 mm links, 0.40 mm tief
 Streuwert 1.37, horizontal: 1.36, vertikal: 1.37

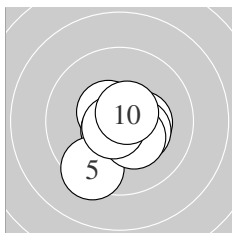
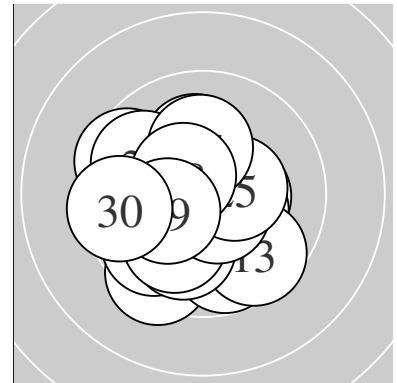

Serie 1:
 10.7 * 10.7 * 10.5 * 10.6 * 9.4 ↘
 10.3 * 10.3 * 10.3 * 10.7 * 10.6 *
 beste Teiler 61.5 (9.) 61.8 (2.) 62.1 (1.)
 Trefferlage 0.07 mm rechts, 0.61 mm tief
 Streuwert 1.10, horizontal: 1.08, vertikal: 1.11

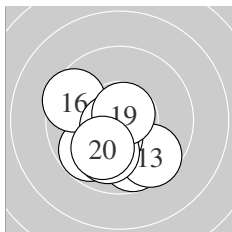

Serie 2:
 9.8 ↓ 9.8 ↙ 9.6 ↘ 10.4 * 10.7 *
 9.5 ↖ 10.7 * 10.0 ↓ 10.7 * 10.0 ↘
 beste Teiler 51.6 (19.) 69.1 (15.) 73.0 (17.)
 Trefferlage 0.58 mm links, 1.15 mm tief
 Streuwert 1.47, horizontal: 1.51, vertikal: 1.43

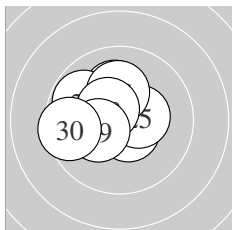

Serie 3:
 10.5 * 10.1 ↑ 10.8 * 10.6 * 10.4 *
 9.8 ↖ 10.2 * 10.5 * 10.3 * 9.5 ←
 beste Teiler 49.4 (23.) 95.0 (24.) 112.6 (21.)
 Trefferlage 0.78 mm links, 0.55 mm hoch
 Streuwert 1.26, horizontal: 1.44, vertikal: 1.04

Unterschrift des Schützen

Ergebnis: **307.9** (293)
 Serien: 101.5 102.9 103.5
 Zähler: 23 7 0 0 0 0 0 0 0 0
 Innenzehner: 17
 weiteste: 294 (12), 277 (7), 273 (8)
 beste Teiler 37.0 (26.) 42.5 (16.) 44.7 (4.)
 Trefferlage 0.39 mm links, 0.03 mm hoch
 Streuwert 1.34, horizontal: 1.42, vertikal: 1.27

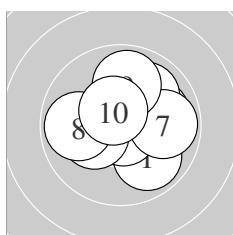
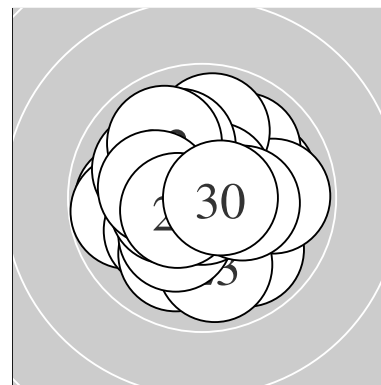

Serie 1:
 9.9 ↘ 10.0 → 10.5 * 10.8 * 10.0 ↗
 10.2 * 9.8 → 9.9 ← 9.9 ↑ 10.5 *
 beste Teiler 44.7 (4.) 105.9 (3.) 106.4 (10.)
 Trefferlage 0.42 mm rechts, 0.42 mm hoch
 Streuwert 1.55, horizontal: 1.74, vertikal: 1.33

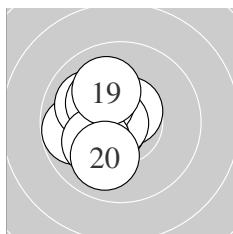

Serie 2:
 10.6 * 9.8 ← 10.6 * 10.7 * 10.0 ↖
 10.8 * 10.2 * 10.1 ↙ 10.1 ↗ 10.0 ↘
 beste Teiler 42.5 (16.) 67.1 (14.) 76.5 (13.)
 Trefferlage 1.10 mm links, 0.03 mm hoch
 Streuwert 1.12, horizontal: 0.94, vertikal: 1.27

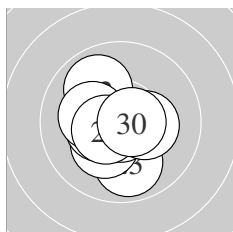

Serie 3:
 10.5 * 9.9 ↖ 9.9 ↓ 10.3 * 10.4 *
 10.8 * 10.2 * 10.3 * 10.5 * 10.7 *
 beste Teiler 37.0 (26.) 72.0 (30.) 107.7 (29.)
 Trefferlage 0.49 mm links, 0.34 mm tief
 Streuwert 1.17, horizontal: 1.12, vertikal: 1.21

Unterschrift des Schützen

Meyton Elektronik

Ergebnis: **308.1** (294)
 Serien: 101.8 103.2 103.1
 Zähler: 25 4 1 0 0 0 0 0 0 0
 Innenzehner: 21
 weiteste: 562 (8), 304 (21), 259 (5)
 beste Teiler 59.0 (16.) 70.7 (4.) 71.0 (23.)
 Trefferlage 0.79 mm links, 0.30 mm hoch
 Streuwert 1.26, horizontal: 1.43, vertikal: 1.07

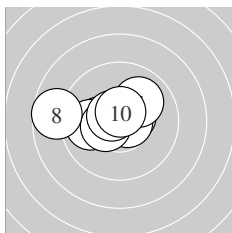
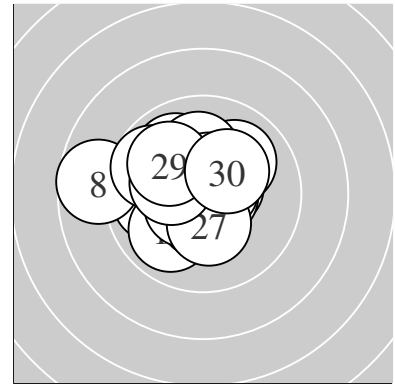

Serie 1:
 10.2 * 10.2 * 10.5 * 10.7 * 9.9 ←
 10.4 * 10.0 ↗ 8.7 ← 10.6 * 10.6 *
 beste Teiler 70.7 (4.) 83.3 (10.) 84.0 (9.)
 Trefferlage 1.01 mm links, 0.28 mm hoch
 Streuwert 1.57, horizontal: 2.11, vertikal: 0.67

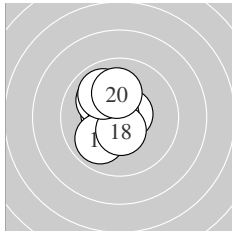

Serie 2:
 10.4 * 10.6 * 10.5 * 10.1 ↘ 10.5 *
 10.7 * 9.9 ↙ 10.5 * 9.9 ↘ 10.1 ↑
 beste Teiler 59.0 (16.) 76.8 (12.) 111.3 (15.)
 Trefferlage 0.73 mm links, 0.33 mm hoch
 Streuwert 1.13, horizontal: 0.80, vertikal: 1.38

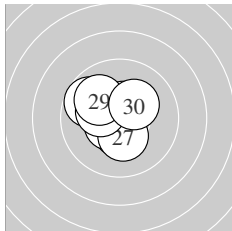

Serie 3:
 9.7 ↘ 10.5 * 10.7 * 10.5 * 10.5 *
 10.5 * 10.3 * 10.2 * 10.0 ↘ 10.2 *
 beste Teiler 71.0 (23.) 107.8 (24.) 108.7 (26.)
 Trefferlage 0.63 mm links, 0.29 mm hoch
 Streuwert 1.17, horizontal: 1.18, vertikal: 1.17

Unterschrift des Schützen

Ergebnis: **307.5** (295)
 Serien: 101.1 102.7 103.7
 Zähler: 25 5 0 0 0 0 0 0 0 0
 Innenzehner: 19
 weiteste: 386 (7), 362 (14), 332 (30)
 beste Teiler 7.2 (24.) 42.1 (25.) 48.2 (29.)
 Trefferlage 0.09 mm links, 0.47 mm tief
 Streuwert 1.38, horizontal: 1.29, vertikal: 1.47

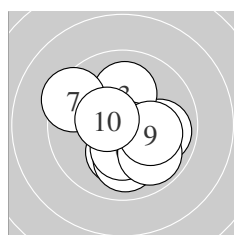
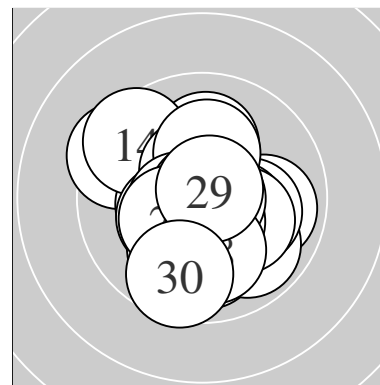

Serie 1:
 9.9 → 10.2 * 10.1 ↑ 10.0 ↓ 10.7 *
 10.3 * 9.4 ↖ 9.9 ↘ 10.1 → 10.5 *
 beste Teiler 72.6 (5.) 116.4 (10.) 160.0 (6.)
 Trefferlage 0.23 mm rechts, 0.50 mm tief
 Streuwert 1.65, horizontal: 1.73, vertikal: 1.57

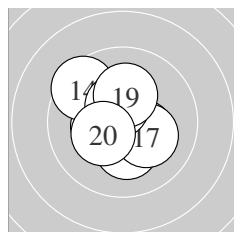

Serie 2:
 10.4 * 10.3 * 10.2 * 9.5 ↖ 10.3 *
 10.8 * 10.2 * 10.5 * 10.2 * 10.3 *
 beste Teiler 50.0 (16.) 118.5 (18.) 141.5 (11.)
 Trefferlage 0.27 mm links, 0.23 mm hoch
 Streuwert 1.37, horizontal: 1.32, vertikal: 1.42

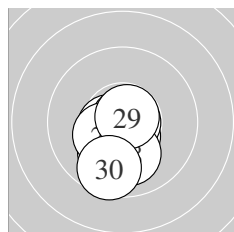

Serie 3:
 10.0 ↓ 10.5 * 10.6 * 10.9 * 10.8 *
 10.1 ↓ 10.3 * 10.1 ↓ 10.8 * 9.6 ↓
 beste Teiler 7.2 (24.) 42.1 (25.) 48.2 (29.)
 Trefferlage 0.22 mm links, 1.14 mm tief
 Streuwert 0.98, horizontal: 0.69, vertikal: 1.21

Unterschrift des Schützen

Meyton Elektronik

Ergebnis: **303.3** (290)
 Serien: 100.6 101.7 101.0
 Zähler: 21 8 1 0 0 0 0 0 0 0
 Innenzehner: 14
 weiteste: 625 (5), 466 (30), 433 (26)
 beste Teiler 13.0 (16.) 30.3 (9.) 34.3 (27.)
 Trefferlage 0.14 mm rechts, 0.50 mm hoch
 Streuwert 1.77, horizontal: 2.20, vertikal: 1.21

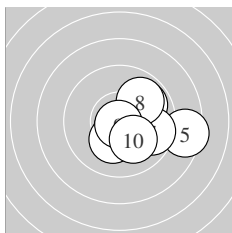
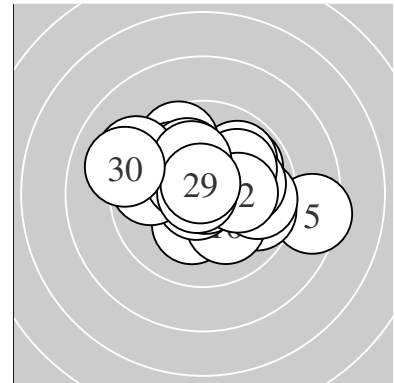

Serie 1:
 10.1 ↘ 10.7 * 9.9 ↗ 10.7 * 8.5 →
 10.2 * 9.7 ↘ 9.9 ↗ 10.8 * 10.1 ↘
 beste Teiler 30.3 (9.) 59.2 (4.) 68.8 (2.)
 Trefferlage 1.57 mm rechts, 0.45 mm tief
 Streuwert 1.67, horizontal: 2.02, vertikal: 1.22

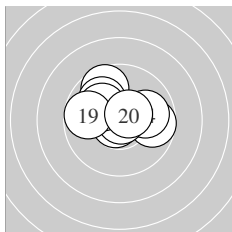

Serie 2:
 10.8 * 10.3 * 9.7 → 10.0 → 9.6 ↖
 10.9 * 10.0 ↖ 10.1 ↖ 9.8 ← 10.5 *
 beste Teiler 13.0 (16.) 50.9 (11.) 102.0 (20.)
 Trefferlage 0.28 mm links, 0.79 mm hoch
 Streuwert 1.53, horizontal: 1.92, vertikal: 1.01

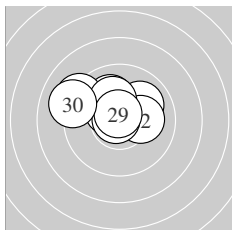

Serie 3:
 10.0 ↗ 10.2 * 10.1 ↖ 10.3 * 10.4 *
 9.2 ↖ 10.8 * 10.2 * 10.7 * 9.1 ←
 beste Teiler 34.3 (27.) 60.8 (29.) 132.7 (25.)
 Trefferlage 0.85 mm links, 1.16 mm hoch
 Streuwert 1.54, horizontal: 2.05, vertikal: 0.76

Unterschrift des Schützen

Ergebnis: **309.8** (295)
 Serien: 102.6 102.6 104.6
 Zähler: 25 5 0 0 0 0 0 0 0 0
 Innenzehner: 21
 weiteste: 321 (16), 301 (6), 282 (5)
 beste Teiler 12.5 (7.) 13.4 (13.) 19.2 (26.)
 Trefferlage 0.11 mm links, 0.41 mm hoch
 Streuwert 1.23, horizontal: 1.39, vertikal: 1.06

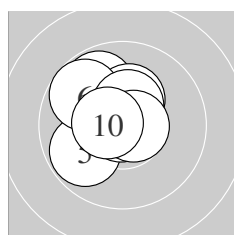
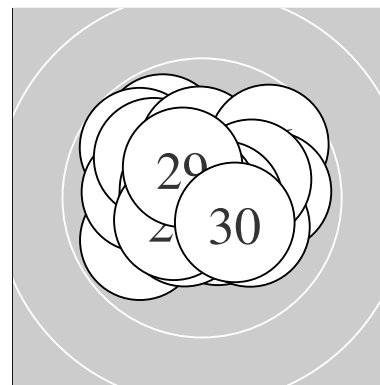

Serie 1:
 10.1 ↘ 9.8 ↘ 10.3 * 10.3 * 9.8 ↙
 9.7 ↘ 10.9 * 10.4 * 10.7 * 10.6 *
 beste Teiler 12.5 (7.) 68.2 (9.) 96.0 (10.)
 Trefferlage 0.83 mm links, 0.82 mm hoch
 Streuwert 1.16, horizontal: 1.11, vertikal: 1.21

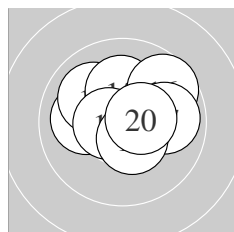

Serie 2:
 10.0 ← 10.3 * 10.9 * 10.0 ↘ 10.2 *
 9.7 ↗ 9.9 → 10.6 * 10.5 * 10.5 *
 beste Teiler 13.4 (13.) 87.4 (18.) 117.2 (20.)
 Trefferlage 0.31 mm rechts, 0.59 mm hoch
 Streuwert 1.36, horizontal: 1.67, vertikal: 0.97

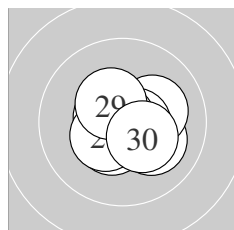

Serie 3:
 10.4 * 10.1 ↘ 10.2 * 10.6 * 10.6 *
 10.9 * 10.7 * 10.4 * 10.4 * 10.3 *
 beste Teiler 19.2 (26.) 56.0 (27.) 79.7 (25.)
 Trefferlage 0.16 mm rechts, 0.17 mm tief
 Streuwert 0.98, horizontal: 1.14, vertikal: 0.78

Unterschrift des Schützen

Meyton Elektronik

Ergebnis: **313.4** (299)
 Serien: 103.7 104.5 105.2
 Zähler: 29 1 0 0 0 0 0 0 0 0
 Innenzehner: 24
 weiteste: 287 (14), 234 (21), 234 (25)
 beste Teiler 18.9 (18.) 28.2 (27.) 43.0 (6.)
 Trefferlage 0.38 mm rechts, 0.03 mm hoch
 Streuwert 1.01, horizontal: 0.95, vertikal: 1.07

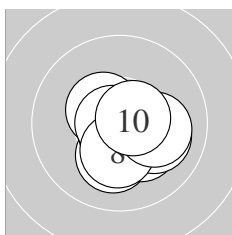
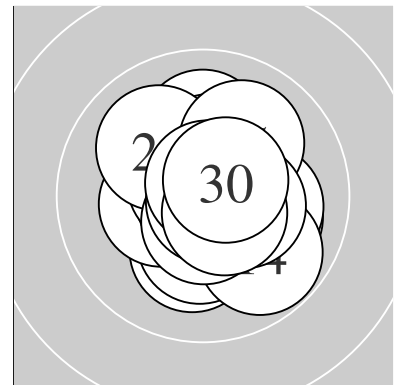

Serie 1:
 10.2 * 10.3 * 10.4 * 10.7 * 10.2 *
 10.8 * 10.1 → 10.3 * 10.1 → 10.6 *
 beste Teiler 43.0 (6.) 61.0 (4.) 85.4 (10.)
 Trefferlage 0.55 mm rechts, 0.61 mm tief
 Streuwert 0.99, horizontal: 1.12, vertikal: 0.85

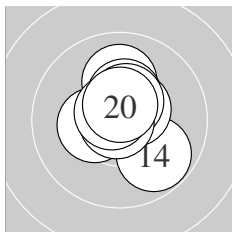

Serie 2:
 10.0 ↑ 10.8 * 10.4 * 9.8 ↘ 10.3 *
 10.5 * 10.5 * 10.9 * 10.7 * 10.6 *
 beste Teiler 18.9 (18.) 48.8 (12.) 66.4 (19.)
 Trefferlage 0.17 mm rechts, 0.48 mm hoch
 Streuwert 1.03, horizontal: 0.90, vertikal: 1.15

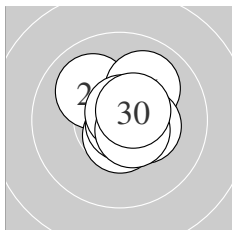

Serie 3:
 10.0 ↙ 10.8 * 10.6 * 10.6 * 10.0 ↗
 10.4 * 10.8 * 10.8 * 10.6 * 10.6 *
 beste Teiler 28.2 (27.) 48.0 (22.) 49.0 (28.)
 Trefferlage 0.42 mm rechts, 0.22 mm hoch
 Streuwert 0.91, horizontal: 0.85, vertikal: 0.96

Unterschrift des Schützen

Meyton Elektronik

Ergebnis: **311.9** (300)
 Serien: 103.0 103.6 105.3
 Zähler: 30 0 0 0 0 0 0 0 0 0
 Innenzehner: 24
 weiteste: 249 (13), 246 (11), 207 (15)
 beste Teiler 14.8 (12.) 39.5 (24.) 63.3 (29.)
 Trefferlage 0.26 mm links, 0.26 mm hoch
 Streuwert 1.03, horizontal: 1.14, vertikal: 0.91

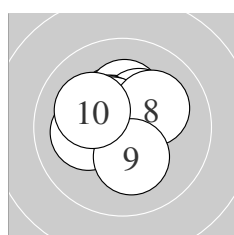
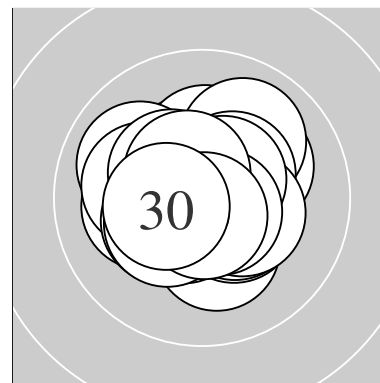

Serie 1:
 10.4 * 10.3 * 10.5 * 10.3 * 10.4 *
 10.1 ← 10.6 * 10.1 ↗ 10.2 * 10.1 ↖
 beste Teiler 96.3 (7.) 102.2 (3.) 126.9 (5.)
 Trefferlage 0.32 mm links, 0.67 mm hoch
 Streuwert 1.09, horizontal: 1.17, vertikal: 1.00

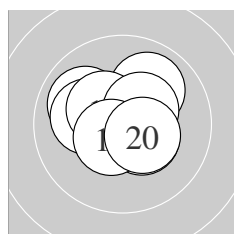

Serie 2:
 10.0 ↗ 10.9 * 10.0 ↖ 10.5 * 10.1 ←
 10.4 * 10.4 * 10.4 * 10.5 * 10.4 *
 beste Teiler 14.8 (12.) 102.8 (19.) 116.3 (14.)
 Trefferlage 0.22 mm links, 0.38 mm hoch
 Streuwert 1.17, horizontal: 1.37, vertikal: 0.91

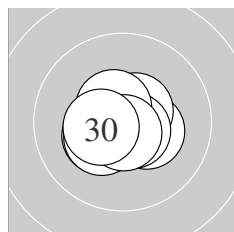

Serie 3:
 10.7 * 10.3 * 10.3 * 10.8 * 10.6 *
 10.6 * 10.3 * 10.6 * 10.7 * 10.4 *
 beste Teiler 39.5 (24.) 63.3 (29.) 67.6 (21.)
 Trefferlage 0.24 mm links, 0.24 mm tief
 Streuwert 0.79, horizontal: 0.94, vertikal: 0.60

Unterschrift des Schützen

Ergebnis: **305.6** (292)
 Serien: 100.8 103.0 101.8
 Zähler: 22 8 0 0 0 0 0 0 0 0
 Innenzehner: 17
 weiteste: 427 (25), 345 (18), 340 (24)
 beste Teiler 35.6 (20.) 35.7 (23.) 39.0 (22.)
 Trefferlage 0.08 mm rechts, 0.33 mm hoch
 Streuwert 1.56, horizontal: 1.57, vertikal: 1.54

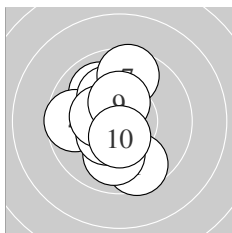
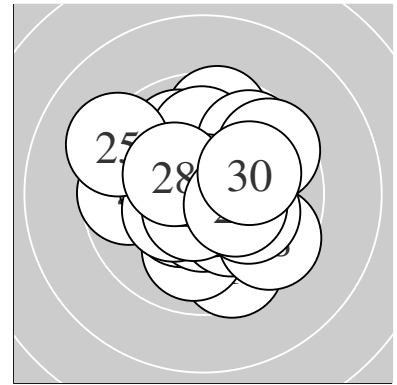

Serie 1:
 9.6 ↘ 10.0 ↓ 10.0 ↖ 9.7 ← 10.2 *
 10.4 * 9.6 ↑ 10.4 * 10.4 * 10.5 *
 beste Teiler 113.0 (10.) 130.1 (6.) 136.0 (9.)
 Trefferlage 0.64 mm links, 0.12 mm hoch
 Streuwert 1.69, horizontal: 1.24, vertikal: 2.04

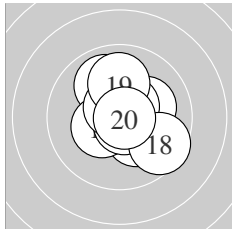

Serie 2:
 9.9 ↖ 10.2 * 10.2 * 10.4 * 10.7 *
 10.6 * 10.6 * 9.6 ↘ 10.0 ↑ 10.8 *
 beste Teiler 35.6 (20.) 57.4 (15.) 81.4 (17.)
 Trefferlage 0.44 mm rechts, 0.24 mm hoch
 Streuwert 1.35, horizontal: 1.28, vertikal: 1.42

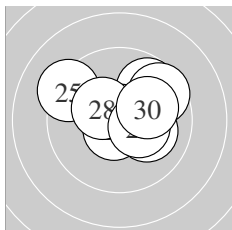

Serie 3:
 9.8 ↗ 10.8 * 10.8 * 9.6 ↗ 9.2 ↖
 10.6 * 10.1 ↘ 10.4 * 10.4 * 10.1 →
 beste Teiler 35.7 (23.) 39.0 (22.) 77.6 (26.)
 Trefferlage 0.45 mm rechts, 0.64 mm hoch
 Streuwert 1.62, horizontal: 1.98, vertikal: 1.15

Unterschrift des Schützen

Ergebnis: **312.5** (297)
 Serien: 103.8 104.6 104.1
 Zähler: 27 3 0 0 0 0 0 0 0 0
 Innenzehner: 25
 weiteste: 314 (8), 292 (9), 269 (30)
 beste Teiler 35.1 (7.) 37.8 (18.) 42.2 (10.)
 Trefferlage 0.48 mm links, 0.14 mm hoch
 Streuwert 1.05, horizontal: 1.05, vertikal: 1.06

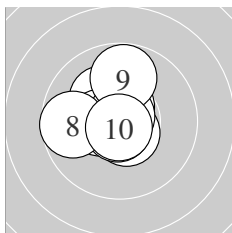
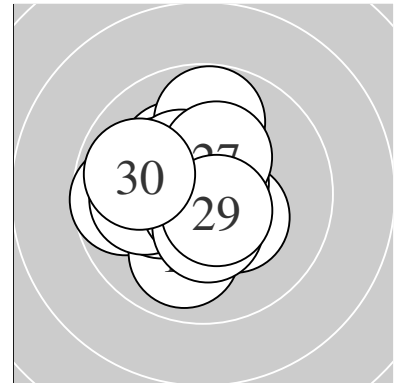

Serie 1:
 10.2 * 10.6 * 10.6 * 10.2 * 10.4 *
 10.7 * 10.8 * 9.7 ← 9.8 ↑ 10.8 *
 beste Teiler 35.1 (7.) 42.2 (10.) 51.9 (6.)
 Trefferlage 0.57 mm links, 0.51 mm hoch
 Streuwert 1.13, horizontal: 1.09, vertikal: 1.17

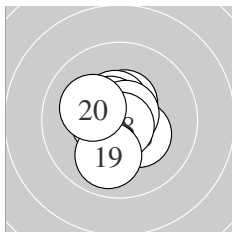

Serie 2:
 10.5 * 10.5 * 10.5 * 10.5 * 10.6 *
 10.3 * 10.7 * 10.8 * 10.0 ↓ 10.2 *
 beste Teiler 37.8 (18.) 59.4 (17.) 94.2 (15.)
 Trefferlage 0.16 mm links, 0.03 mm tief
 Streuwert 1.01, horizontal: 0.91, vertikal: 1.11

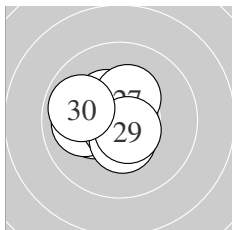

Serie 3:
 10.7 * 10.7 * 10.3 * 10.4 * 10.0 ←
 10.8 * 10.3 * 10.4 * 10.6 * 9.9 ←
 beste Teiler 48.5 (26.) 64.7 (21.) 74.6 (22.)
 Trefferlage 0.69 mm links, 0.04 mm tief
 Streuwert 1.03, horizontal: 1.15, vertikal: 0.90

Unterschrift des Schützen

Ergebnis: **310.7** (296)
 Serien: 103.3 105.1 102.3
 Zähler: 26 4 0 0 0 0 0 0 0 0
 Innenzehner: 24
 weiteste: 320 (5), 280 (21), 263 (28)
 beste Teiler 21.9 (20.) 25.8 (16.) 37.3 (11.)
 Trefferlage 0.51 mm rechts, 0.26 mm tief
 Streuwert 1.13, horizontal: 1.13, vertikal: 1.13

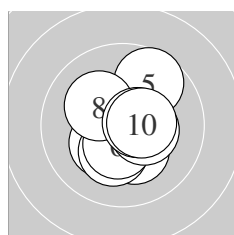
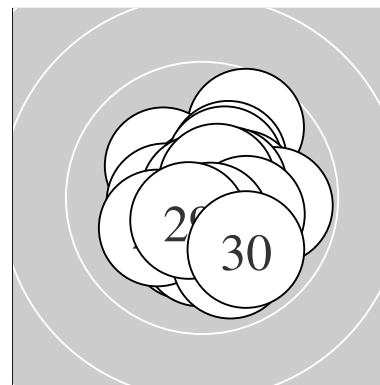

Serie 1:
 10.3 * 10.3 * 10.2 * 10.6 * 9.7 ↗
 10.5 * 10.4 * 10.2 * 10.6 * 10.5 *
 beste Teiler 82.2 (4.) 95.5 (9.) 122.8 (10.)
 Trefferlage 0.32 mm rechts, 0.15 mm tief
 Streuwert 1.26, horizontal: 1.13, vertikal: 1.37

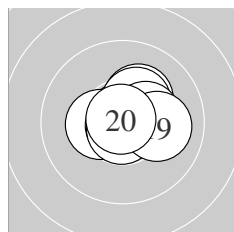

Serie 2:
 10.8 * 10.2 * 10.3 * 10.4 * 10.4 *
 10.9 * 10.3 * 10.8 * 10.1 → 10.9 *
 beste Teiler 21.9 (20.) 25.8 (16.) 37.3 (11.)
 Trefferlage 0.52 mm rechts, 0.25 mm hoch
 Streuwert 0.88, horizontal: 1.06, vertikal: 0.65

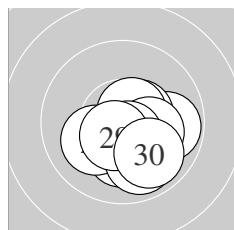

Serie 3:
 9.8 → 10.5 * 10.6 * 10.2 * 10.2 *
 10.6 * 10.1 ↖ 9.9 ↘ 10.5 * 9.9 ↘
 beste Teiler 84.1 (23.) 94.9 (26.) 101.3 (29.)
 Trefferlage 0.68 mm rechts, 0.90 mm tief
 Streuwert 1.15, horizontal: 1.28, vertikal: 1.01

Unterschrift des Schützen

Ergebnis: **287.4** (273)
 Serien: 92.8 97.4 97.2
 Zähler: 7 20 2 1 0 0 0 0 0 0
 Innenzehner: 5
 weiteste: 861 (9), 645 (28), 594 (6)
 beste Teiler 87.0 (12.) 104.1 (1.) 119.0 (22.)
 Trefferlage 0.78 mm links, 0.70 mm tief
 Streuwert 2.61, horizontal: 3.12, vertikal: 1.98

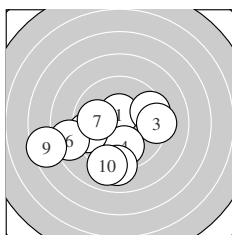
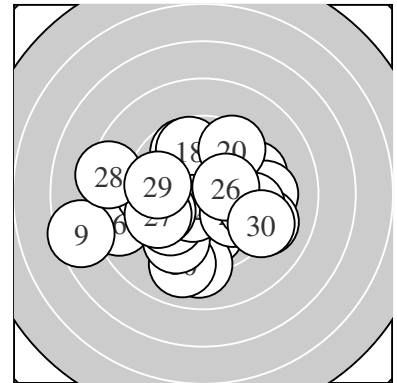

Serie 1:
 10.5 * 9.5 → 9.3 → 9.9 ↓ 9.5 ←
 8.6 ← 9.9 ← 9.1 ↓ 7.5 ← 9.0 ↓
 beste Teiler 104.1 (1.) 251.7 (7.) 259.0 (4.)
 Trefferlage 1.35 mm links, 1.48 mm tief
 Streuwert 3.11, horizontal: 3.81, vertikal: 2.20

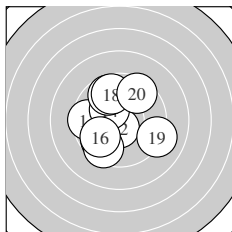

Serie 2:
 9.5 ← 10.6 * 9.7 ↙ 10.3 * 9.5 ↘
 9.8 ↙ 9.7 ↘ 9.7 ↘ 9.1 → 9.5 ↗
 beste Teiler 87.0 (12.) 164.7 (14.) 287.8 (16.)
 Trefferlage 0.69 mm links, 0.00 mm
 Streuwert 2.30, horizontal: 2.25, vertikal: 2.35

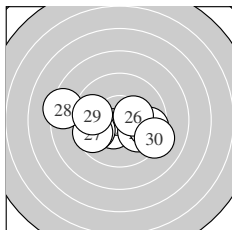

Serie 3:
 10.1 → 10.5 * 10.0 ↘ 9.6 → 9.8 ←
 10.3 * 9.6 ← 8.4 ← 9.7 ← 9.2 →
 beste Teiler 119.0 (22.) 159.7 (26.) 211.2 (21.)
 Trefferlage 0.31 mm links, 0.61 mm tief
 Streuwert 2.48, horizontal: 3.36, vertikal: 1.04

Unterschrift des Schützen

Ergebnis: **296.0** (282)
 Serien: 100.6 97.6 97.8
 Zähler: 15 12 3 0 0 0 0 0 0 0
 Innenzehner: 10
 weiteste: 703 (30), 603 (18), 549 (28)
 beste Teiler 57.5 (4.) 70.9 (29.) 71.0 (13.)
 Trefferlage 0.30 mm rechts, 0.50 mm hoch
 Streuwert 2.21, horizontal: 2.32, vertikal: 2.09

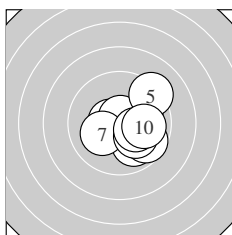
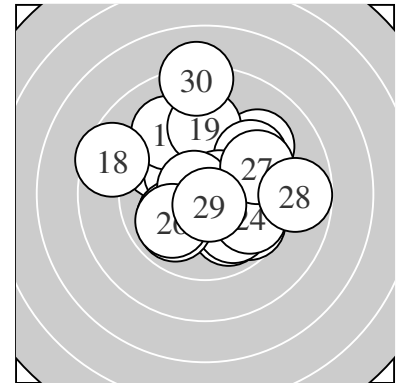

Serie 1:
 10.6 * 9.9 ↘ 10.0 → 10.7 * 9.2 ↗
 9.7 ↘ 10.1 ↙ 10.1 ↘ 10.3 * 10.0 →
 beste Teiler 57.5 (4.) 97.0 (1.) 175.8 (9.)
 Trefferlage 1.25 mm rechts, 0.28 mm tief
 Streuwert 1.55, horizontal: 1.62, vertikal: 1.47

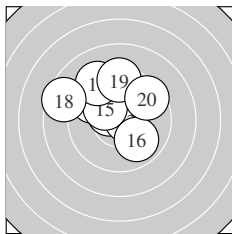

Serie 2:
 10.2 * 10.5 * 10.7 * 9.6 ↘ 10.2 *
 9.9 ↘ 9.2 ↘ 8.5 ↖ 9.3 ↑ 9.5 ↗
 beste Teiler 71.0 (13.) 121.5 (12.) 191.2 (11.)
 Trefferlage 0.90 mm links, 1.55 mm hoch
 Streuwert 2.10, horizontal: 2.40, vertikal: 1.75

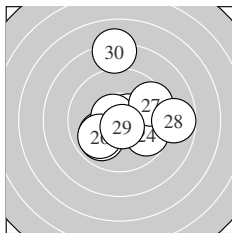

Serie 3:
 10.0 ↙ 10.6 * 10.6 * 9.7 ↘ 9.9 ↙
 9.9 ↙ 9.5 → 8.8 → 10.7 * 8.1 ↑
 beste Teiler 70.9 (29.) 77.0 (23.) 95.2 (22.)
 Trefferlage 0.55 mm rechts, 0.24 mm hoch
 Streuwert 2.57, horizontal: 2.52, vertikal: 2.63

Unterschrift des Schützen

Ergebnis: **302.4** (288)
 Serien: 99.8 102.1 100.5
 Zähler: 19 10 1 0 0 0 0 0 0 0
 Innenzehner: 12
 weiteste: 532 (1), 378 (15), 342 (25)
 beste Teiler 5.3 (20.) 43.0 (16.) 63.5 (9.)
 Trefferlage 0.05 mm links, 0.65 mm hoch
 Streuwert 1.68, horizontal: 2.00, vertikal: 1.28

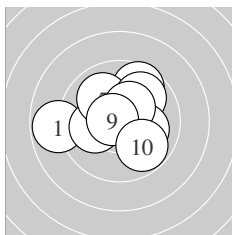
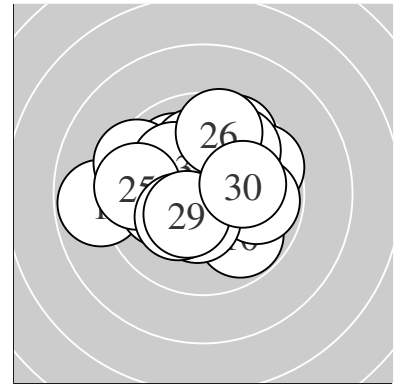

Serie 1:
 8.8 ← 9.6 ↗ 10.4 * 10.1 ← 10.0 ↘
 9.9 ↗ 10.1 → 10.4 * 10.7 * 9.8 ↘
 beste Teiler 63.5 (9.) 145.6 (8.) 150.3 (3.)
 Trefferlage 0.19 mm links, 0.57 mm hoch
 Streuwert 1.99, horizontal: 2.34, vertikal: 1.54

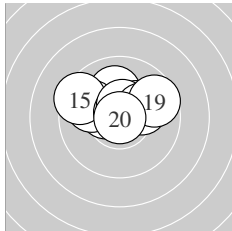

Serie 2:
 10.5 * 10.1 ↑ 9.9 ↖ 10.3 * 9.4 ↖
 10.8 * 10.5 * 10.1 → 9.6 → 10.9 *
 beste Teiler 5.3 (20.) 43.0 (16.) 103.8 (17.)
 Trefferlage 0.08 mm links, 0.95 mm hoch
 Streuwert 1.45, horizontal: 1.94, vertikal: 0.65

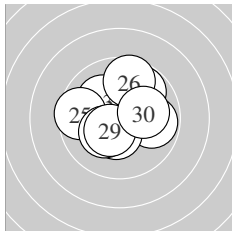

Serie 3:
 10.5 * 9.8 → 10.1 ↘ 9.8 ↗ 9.6 ←
 9.6 ↑ 10.4 * 10.2 * 10.4 * 10.1 →
 beste Teiler 102.8 (21.) 135.2 (29.) 136.1 (27.)
 Trefferlage 0.10 mm rechts, 0.43 mm hoch
 Streuwert 1.72, horizontal: 1.91, vertikal: 1.51

Unterschrift des Schützen

Ergebnis: **309.4** (293)
 Serien: 103.5 103.5 102.4
 Zähler: 23 7 0 0 0 0 0 0 0 0
 Innenzehner: 20
 weiteste: 310 (20), 305 (9), 301 (5)
 beste Teiler 7.6 (11.) 8.2 (2.) 51.4 (10.)
 Trefferlage 0.29 mm rechts, 0.71 mm hoch
 Streuwert 1.19, horizontal: 1.38, vertikal: 0.95

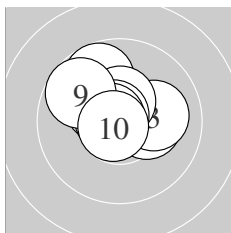
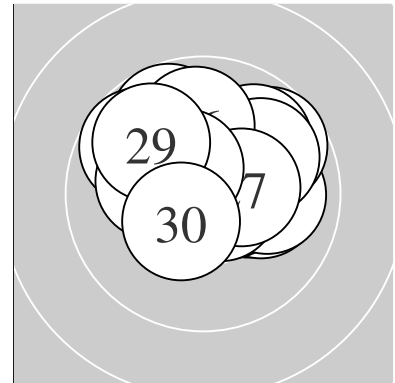

Serie 1:
 10.3 * 10.9 * 10.1 → 10.3 * 9.7 ↖
 10.4 * 10.7 * 10.7 * 9.7 ↗ 10.7 *
 beste Teiler 8.2 (2.) 51.4 (10.) 53.7 (7.)
 Trefferlage 0.25 mm links, 0.72 mm hoch
 Streuwert 1.19, horizontal: 1.38, vertikal: 0.96

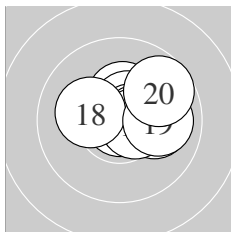

Serie 2:
 10.9 * 10.1 → 10.4 * 10.5 * 10.7 *
 10.5 * 10.5 * 10.2 * 10.0 → 9.7 ↗
 beste Teiler 7.6 (11.) 74.3 (15.) 101.4 (17.)
 Trefferlage 0.89 mm rechts, 0.42 mm hoch
 Streuwert 1.07, horizontal: 1.33, vertikal: 0.74

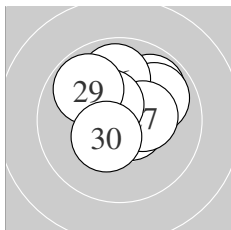

Serie 3:
 9.9 ↗ 10.6 * 9.9 ↗ 10.7 * 10.3 *
 9.9 ↑ 10.4 * 10.5 * 9.8 ↖ 10.4 *
 beste Teiler 73.3 (24.) 79.5 (22.) 121.2 (28.)
 Trefferlage 0.24 mm rechts, 1.00 mm hoch
 Streuwert 1.23, horizontal: 1.33, vertikal: 1.13

Unterschrift des Schützen

Ergebnis: **300.9** (287)
 Serien: 100.1 101.7 99.1
 Zähler: 18 11 1 0 0 0 0 0 0 0
 Innenzehner: 14
 weiteste: 506 (26), 486 (9), 479 (7)
 beste Teiler 16.2 (8.) 54.3 (12.) 69.2 (19.)
 Trefferlage 0.26 mm links, 0.32 mm hoch
 Streuwert 1.87, horizontal: 1.97, vertikal: 1.75

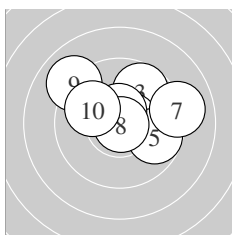
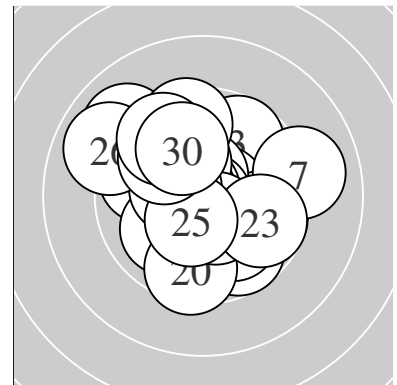

Serie 1:
 10.4 * 10.2 * 9.7 ↗ 10.6 * 9.7 ↘
 10.6 * 9.0 → 10.9 * 9.0 ↖ 10.0 ↖
 beste Teiler 16.2 (8.) 87.5 (4.) 96.1 (6.)
 Trefferlage 0.69 mm rechts, 0.93 mm hoch
 Streuwert 1.90, horizontal: 2.37, vertikal: 1.25

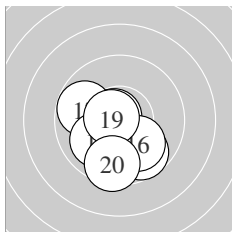

Serie 2:
 10.5 * 10.7 * 9.7 ↘ 10.5 * 10.3 *
 10.0 ↘ 9.8 ↖ 10.0 ↗ 10.7 * 9.5 ↓
 beste Teiler 54.3 (12.) 69.2 (19.) 113.3 (14.)
 Trefferlage 0.51 mm links, 1.07 mm tief
 Streuwert 1.39, horizontal: 1.35, vertikal: 1.42

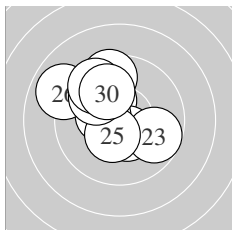

Serie 3:
 10.2 * 10.5 * 9.7 ↘ 10.4 * 10.4 *
 8.9 ↖ 9.5 ↑ 9.9 ↖ 9.6 ↖ 10.0 ↖
 beste Teiler 124.0 (22.) 130.5 (25.) 139.5 (24.)
 Trefferlage 0.95 mm links, 1.11 mm hoch
 Streuwert 1.81, horizontal: 1.87, vertikal: 1.75

Unterschrift des Schützen

Ergebnis: **299.2** (282)
 Serien: 99.0 100.4 99.8
 Zähler: 14 14 2 0 0 0 0 0 0 0
 Innenzehner: 9
 weiteste: 611 (29), 584 (1), 401 (8)
 beste Teiler 7.2 (4.) 26.9 (25.) 60.5 (19.)
 Trefferlage 0.60 mm rechts, 0.95 mm hoch
 Streuwert 1.84, horizontal: 2.13, vertikal: 1.48

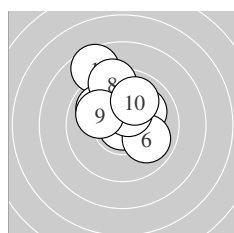
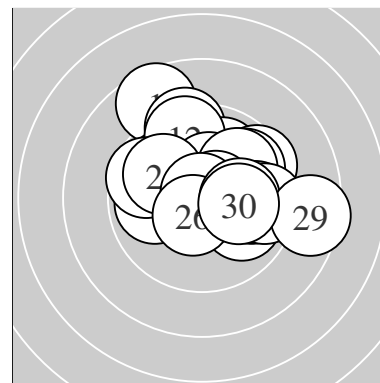

Serie 1:
 8.6 ↖ 10.1 ↗ 10.0 ↑ 10.9 * 9.9 ↘
 9.9 ↘ 10.4 * 9.3 ↑ 10.0 ↘ 9.9 ↑
 beste Teiler 7.2 (4.) 130.2 (7.) 224.3 (2.)
 Trefferlage 0.22 mm links, 1.75 mm hoch
 Streuwert 1.78, horizontal: 1.69, vertikal: 1.86

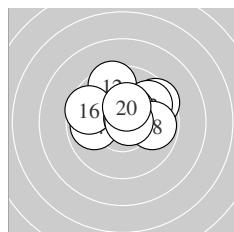

Serie 2:
 9.5 ↗ 9.5 ↑ 9.8 ↗ 9.9 ← 10.5 *
 9.6 ↖ 10.7 * 9.8 → 10.7 * 10.4 *
 beste Teiler 60.5 (19.) 61.4 (17.) 125.3 (15.)
 Trefferlage 0.36 mm rechts, 1.02 mm hoch
 Streuwert 1.70, horizontal: 2.11, vertikal: 1.14

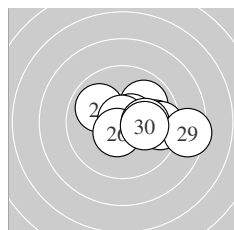

Serie 3:
 9.9 ↗ 10.6 * 9.8 → 9.9 ↘ 10.8 *
 10.5 * 9.6 → 10.1 → 8.5 → 10.1 →
 beste Teiler 26.9 (25.) 84.9 (22.) 109.5 (26.)
 Trefferlage 1.66 mm rechts, 0.07 mm hoch
 Streuwert 1.74, horizontal: 2.30, vertikal: 0.87

Unterschrift des Schützen

Ergebnis: **310.4** (294)
 Serien: 103.5 103.8 103.1
 Zähler: 24 6 0 0 0 0 0 0 0 0
 Innenzehner: 21
 weiteste: 347 (28), 303 (13), 292 (5)
 beste Teiler 34.2 (3.) 39.1 (21.) 39.1 (22.)
 Trefferlage 0.13 mm rechts, 0.24 mm hoch
 Streuwert 1.24, horizontal: 1.45, vertikal: 0.98

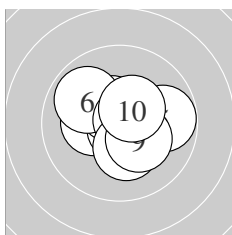
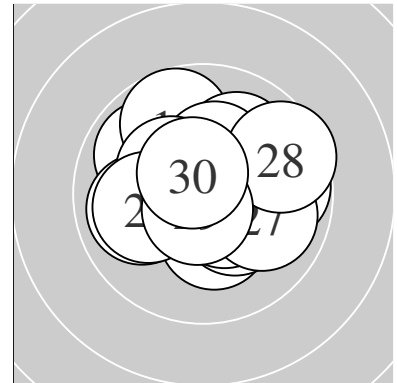

Serie 1:
 10.4 * 10.3 * 10.8 * 10.5 * 9.8 →
 9.9 ↘ 10.8 * 10.3 * 10.3 * 10.4 *
 beste Teiler 34.2 (3.) 50.0 (7.) 107.8 (4.)
 Trefferlage 0.28 mm rechts, 0.07 mm hoch
 Streuwert 1.25, horizontal: 1.49, vertikal: 0.96

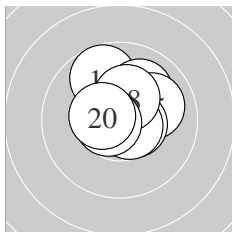

Serie 2:
 10.7 * 10.8 * 9.7 ↗ 10.0 ↗ 10.0 →
 10.6 * 10.6 * 10.3 * 10.6 * 10.5 *
 beste Teiler 40.8 (12.) 67.1 (11.) 77.5 (17.)
 Trefferlage 0.17 mm rechts, 0.68 mm hoch
 Streuwert 1.10, horizontal: 1.12, vertikal: 1.08

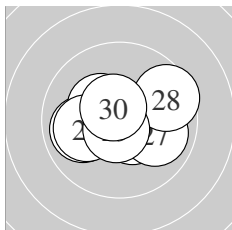

Serie 3:
 10.8 * 10.8 * 9.9 ← 10.3 * 10.5 *
 10.0 ← 9.9 → 9.6 ↗ 10.7 * 10.6 *
 beste Teiler 39.1 (21.) 39.1 (22.) 66.1 (29.)
 Trefferlage 0.03 mm links, 0.02 mm tief
 Streuwert 1.41, horizontal: 1.81, vertikal: 0.83

Unterschrift des Schützen

Meyton Elektronik

Ergebnis: **311.3** (297)
 Serien: 102.6 104.7 104.0
 Zähler: 27 3 0 0 0 0 0 0 0 0
 Innenzehner: 26
 weiteste: 306 (10), 293 (6), 279 (1)
 beste Teiler 17.0 (23.) 35.5 (24.) 65.7 (12.)
 Trefferlage 0.07 mm rechts, 0.01 mm hoch
 Streuwert 1.16, horizontal: 1.26, vertikal: 1.04

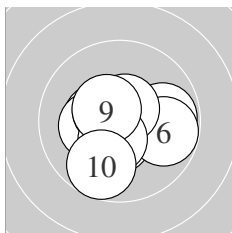
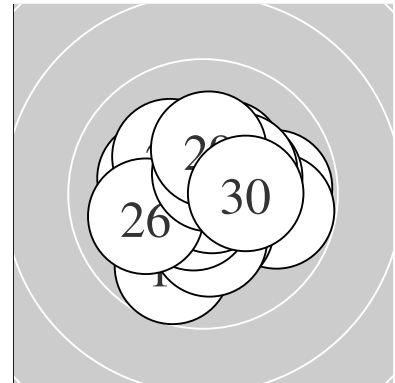

Serie 1:
 9.8 → 10.4 * 10.5 * 10.3 * 10.5 *
 9.8 → 10.6 * 10.5 * 10.5 * 9.7 ↙
 beste Teiler 87.8 (7.) 107.1 (5.) 114.6 (9.)
 Trefferlage 0.06 mm links, 0.33 mm tief
 Streuwert 1.41, horizontal: 1.63, vertikal: 1.15

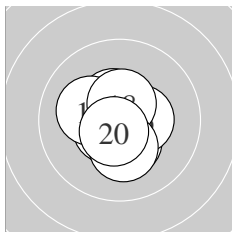

Serie 2:
 10.4 * 10.7 * 10.6 * 10.5 * 10.6 *
 10.4 * 10.2 * 10.5 * 10.2 * 10.6 *
 beste Teiler 65.7 (12.) 81.8 (20.) 90.3 (15.)
 Trefferlage 0.02 mm links, 0.21 mm tief
 Streuwert 0.93, horizontal: 0.90, vertikal: 0.97

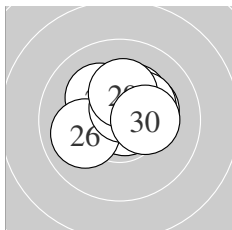

Serie 3:
 10.3 * 10.3 * 10.9 * 10.8 * 10.2 *
 10.0 ← 10.6 * 10.3 * 10.3 * 10.3 *
 beste Teiler 17.0 (23.) 35.5 (24.) 83.1 (27.)
 Trefferlage 0.30 mm rechts, 0.60 mm hoch
 Streuwert 1.06, horizontal: 1.25, vertikal: 0.82

Unterschrift des Schützen

Ergebnis: **298.5** (288)
 Serien: 98.8 98.8 100.9
 Zähler: 18 12 0 0 0 0 0 0 0 0
 Innenzehner: 8
 weiteste: 493 (12), 451 (8), 435 (2)
 beste Teiler 53.0 (5.) 94.6 (15.) 99.1 (23.)
 Trefferlage 0.02 mm links, 0.18 mm hoch
 Streuwert 1.95, horizontal: 2.16, vertikal: 1.70

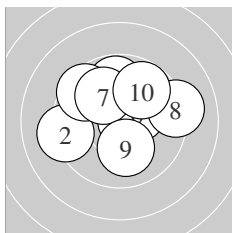
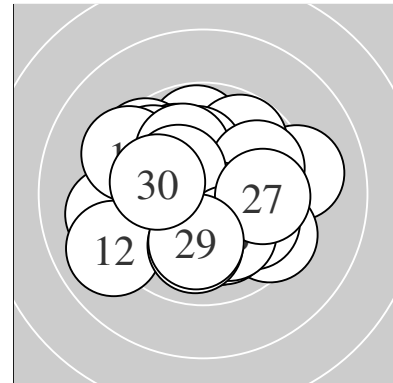

Serie 1:
 9.8 ↑ 9.2 ← 9.5 ↘ 10.3 * 10.7 *
 10.3 * 10.0 ↘ 9.1 → 10.1 ↓ 9.8 ↗
 beste Teiler 53.0 (5.) 151.2 (6.) 155.8 (4.)
 Trefferlage 0.12 mm rechts, 0.91 mm hoch
 Streuwert 2.05, horizontal: 2.43, vertikal: 1.58

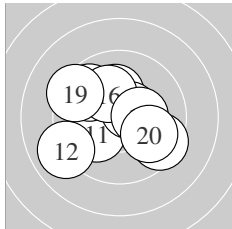

Serie 2:
 10.1 ↙ 9.0 ↙ 10.2 * 9.7 ↘ 10.6 *
 10.1 ↘ 10.3 * 9.5 ↘ 9.4 ↘ 9.9 ↘
 beste Teiler 94.6 (15.) 158.3 (17.) 192.6 (13.)
 Trefferlage 0.52 mm links, 0.11 mm hoch
 Streuwert 2.15, horizontal: 2.48, vertikal: 1.77

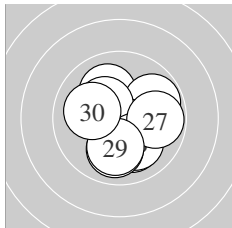

Serie 3:
 10.1 ↘ 9.8 ↗ 10.6 * 10.1 ↓ 10.3 *
 10.1 ↓ 9.8 → 10.0 ↓ 10.0 ↓ 10.1 ←
 beste Teiler 99.1 (23.) 153.8 (25.) 221.6 (26.)
 Trefferlage 0.32 mm rechts, 0.46 mm tief
 Streuwert 1.62, horizontal: 1.61, vertikal: 1.63

Unterschrift des Schützen

Ergebnis: **304.5** (291)
 Serien: 100.7 101.8 102.0
 Zähler: 22 7 1 0 0 0 0 0 0 0
 Innenzehner: 16
 weiteste: 503 (23), 402 (18), 353 (5)
 beste Teiler 37.0 (1.) 51.1 (22.) 58.1 (10.)
 Trefferlage 0.28 mm rechts, 0.27 mm tief
 Streuwert 1.62, horizontal: 1.84, vertikal: 1.36

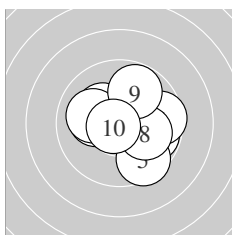
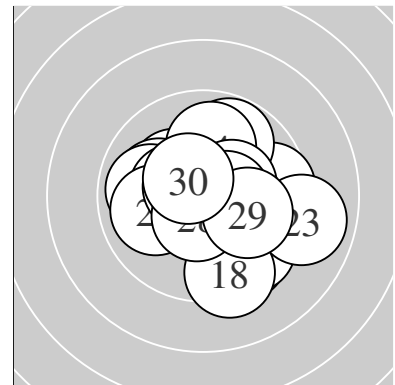

Serie 1:
 10.8 * 9.8 → 10.2 * 10.2 * 9.5 ↘
 10.0 ← 9.6 → 10.1 → 9.8 ↗ 10.7 *
 beste Teiler 37.0 (1.) 58.1 (10.) 177.4 (4.)
 Trefferlage 0.49 mm rechts, 0.00 mm
 Streuwert 1.76, horizontal: 2.03, vertikal: 1.45

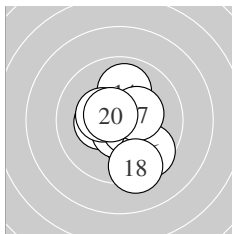

Serie 2:
 10.1 ↘ 10.3 * 10.6 * 10.0 ↑ 10.6 *
 9.6 ↘ 10.3 * 9.3 ↘ 10.4 * 10.6 *
 beste Teiler 86.6 (20.) 93.4 (13.) 97.4 (15.)
 Trefferlage 0.35 mm rechts, 0.61 mm tief
 Streuwert 1.55, horizontal: 1.28, vertikal: 1.79

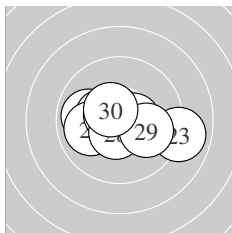

Serie 3:
 9.9 ← 10.7 * 8.9 → 10.4 * 10.0 ←
 10.6 * 10.5 * 10.5 * 10.0 → 10.5 *
 beste Teiler 51.1 (22.) 87.9 (26.) 104.6 (28.)
 Trefferlage 0.00 mm , 0.22 mm tief
 Streuwert 1.67, horizontal: 2.25, vertikal: 0.71

Unterschrift des Schützen

Ergebnis: **307.2** (294)
 Serien: 103.6 100.3 103.3
 Zähler: 24 6 0 0 0 0 0 0 0 0
 Innenzehner: 17
 weiteste: 417 (6), 397 (20), 314 (13)
 beste Teiler 36.6 (28.) 42.1 (1.) 49.3 (3.)
 Trefferlage 0.90 mm links, 0.33 mm tief
 Streuwert 1.29, horizontal: 1.38, vertikal: 1.19

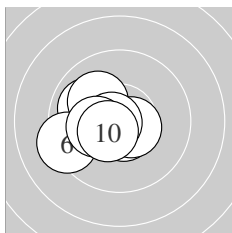
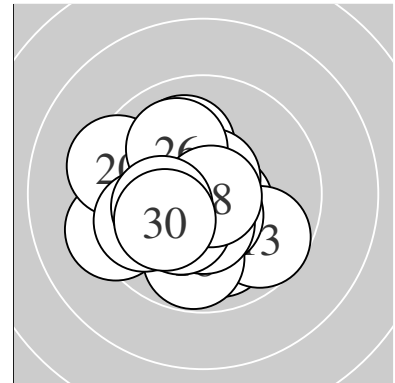

Serie 1:
 10.8 * 9.9 ↖ 10.8 * 10.1 ↘ 10.6 *
 9.3 ← 10.6 * 10.7 * 10.3 * 10.5 *
 beste Teiler 42.1 (1.) 49.3 (3.) 60.0 (8.)
 Trefferlage 0.99 mm links, 0.24 mm tief
 Streuwert 1.17, horizontal: 1.41, vertikal: 0.86

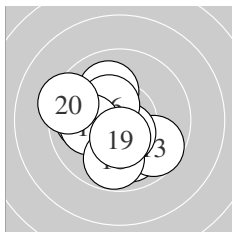

Serie 2:
 10.0 ↗ 10.0 ↓ 9.7 ↘ 10.0 ← 10.5 *
 10.4 * 10.1 ← 9.8 ↓ 10.4 * 9.4 ↖
 beste Teiler 102.9 (15.) 129.0 (19.) 133.4 (16.)
 Trefferlage 0.67 mm links, 0.51 mm tief
 Streuwert 1.72, horizontal: 1.80, vertikal: 1.64

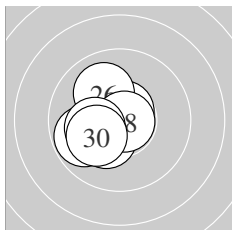

Serie 3:
 9.8 ← 10.4 * 10.7 * 10.4 * 10.6 *
 10.0 ↘ 10.3 * 10.8 * 10.2 * 10.1 ←
 beste Teiler 36.6 (28.) 72.0 (23.) 77.6 (25.)
 Trefferlage 1.04 mm links, 0.23 mm tief
 Streuwert 0.98, horizontal: 0.91, vertikal: 1.04

Unterschrift des Schützen

Ergebnis: **308.9** (293)
 Serien: 104.4 100.7 103.8
 Zähler: 26 3 0 0 1 0 0 0 0 0
 Innenzehner: 22
 weiteste: 1092 (19), 316 (4), 266 (25)
 beste Teiler 7.2 (7.) 25.0 (6.) 40.2 (30.)
 Trefferlage 0.16 mm links, 0.56 mm hoch
 Streuwert 1.75, horizontal: 1.28, vertikal: 2.12

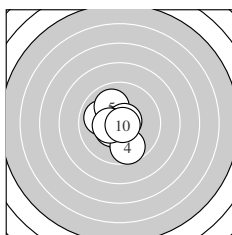
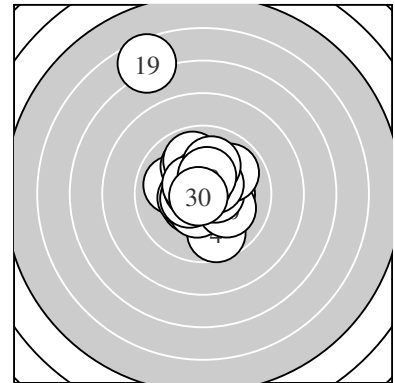

Serie 1:
 10.0 ↙ 10.5 * 10.5 * 9.7 ↘ 10.0 ↗
 10.9 * 10.9 * 10.7 * 10.4 * 10.8 *
 beste Teiler 7.2 (7.) 25.0 (6.) 44.4 (10.)
 Trefferlage 0.33 mm links, 0.23 mm tief
 Streuwert 1.18, horizontal: 1.03, vertikal: 1.31

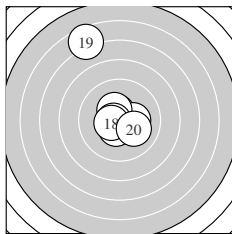

Serie 2:
 10.7 * 10.5 * 10.5 * 10.3 * 10.5 *
 10.4 * 10.6 * 10.5 * 6.6 ↗ 10.1 ↘
 beste Teiler 57.9 (11.) 78.3 (17.) 106.6 (12.)
 Trefferlage 0.34 mm links, 0.90 mm hoch
 Streuwert 2.64, horizontal: 1.76, vertikal: 3.30

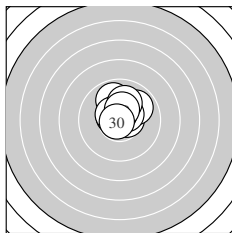

Serie 3:
 10.6 * 9.9 ↗ 10.5 * 10.6 * 9.9 ↗
 10.6 * 10.5 * 10.0 ↑ 10.4 * 10.8 *
 beste Teiler 40.2 (30.) 79.0 (26.) 85.4 (24.)
 Trefferlage 0.19 mm rechts, 1.02 mm hoch
 Streuwert 0.92, horizontal: 0.95, vertikal: 0.89

Unterschrift des Schützen

Ergebnis: **294.3** (281)
 Serien: 100.6 94.7 99.0
 Zähler: 13 15 2 0 0 0 0 0 0 0
 Innenzehner: 11
 weiteste: 636 (14), 558 (18), 489 (11)
 beste Teiler 52.8 (3.) 55.7 (29.) 101.4 (20.)
 Trefferlage 0.74 mm rechts, 0.50 mm hoch
 Streuwert 2.23, horizontal: 2.62, vertikal: 1.75

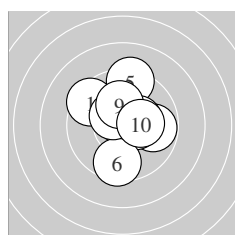
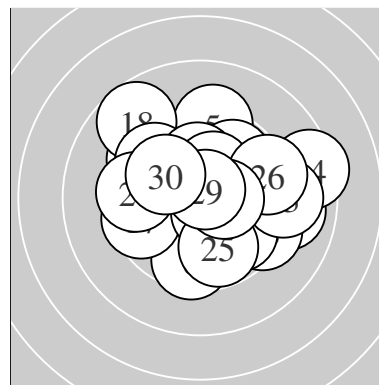

Serie 1:
 9.5 ↘ 9.8 → 10.7 * 10.5 * 9.3 ↑
 9.5 ↓ 10.3 * 10.5 * 10.2 * 10.3 *
 beste Teiler 52.8 (3.) 122.1 (4.) 125.1 (8.)
 Trefferlage 0.30 mm rechts, 0.65 mm hoch
 Streuwert 1.81, horizontal: 1.65, vertikal: 1.97

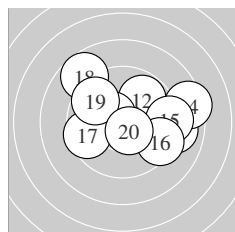

Serie 2:
 9.0 → 9.8 ↗ 10.5 * 8.4 → 9.2 →
 9.4 → 9.5 ← 8.7 ↘ 9.7 ↘ 10.5 *
 beste Teiler 101.4 (20.) 117.6 (13.) 283.0 (12.)
 Trefferlage 1.09 mm rechts, 0.63 mm hoch
 Streuwert 2.87, horizontal: 3.60, vertikal: 1.88

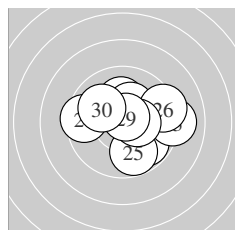

Serie 3:
 9.8 ↘ 10.1 ↑ 9.1 → 10.3 * 9.8 ↓
 9.3 → 9.5 ← 10.4 * 10.7 * 10.0 ↘
 beste Teiler 55.7 (29.) 136.1 (28.) 167.2 (24.)
 Trefferlage 0.83 mm rechts, 0.22 mm hoch
 Streuwert 2.05, horizontal: 2.46, vertikal: 1.52

Unterschrift des Schützen

Meyton Elektronik

Ergebnis: **283.3** (270)
 Serien: 96.0 93.2 94.1
 Zähler: 6 18 6 0 0 0 0 0 0 0
 Innenzehner: 5
 weiteste: 731 (21), 660 (15), 645 (29)
 beste Teiler 115.6 (24.) 130.8 (4.) 169.0 (6.)
 Trefferlage 0.28 mm rechts, 1.86 mm hoch
 Streuwert 2.63, horizontal: 2.90, vertikal: 2.32

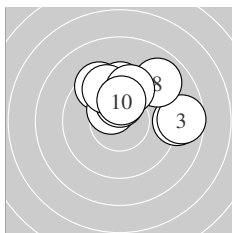
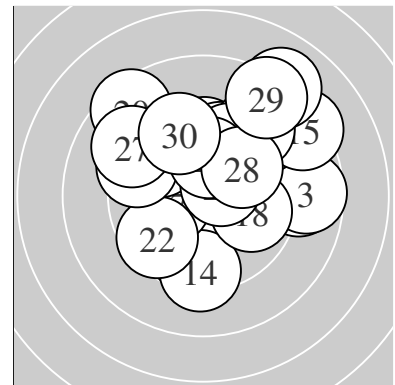

Serie 1:
 8.8 → 9.5 ↘ 8.7 → 10.4 * 9.7 ↑
 10.3 * 9.7 ↘ 9.0 ↗ 9.7 ↑ 10.2 *
 beste Teiler 130.8 (4.) 169.0 (6.) 191.6 (10.)
 Trefferlage 1.17 mm rechts, 2.06 mm hoch
 Streuwert 2.11, horizontal: 2.69, vertikal: 1.31

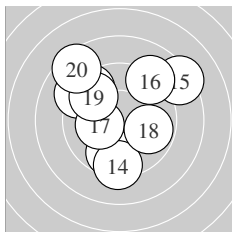

Serie 2:
 9.4 ↘ 9.7 ↓ 9.2 ↘ 9.3 ↓ 8.3 ↗
 9.1 ↗ 10.2 * 9.8 → 9.7 ↘ 8.5 ↘
 beste Teiler 187.7 (17.) 278.9 (18.) 309.2 (12.)
 Trefferlage 0.46 mm links, 1.12 mm hoch
 Streuwert 3.10, horizontal: 3.16, vertikal: 3.03

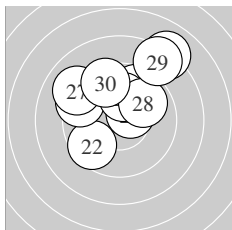

Serie 3:
 8.0 ↗ 9.6 ↙ 9.7 ↗ 10.5 * 9.4 ↘
 10.1 ↑ 9.0 ↘ 9.9 ↗ 8.4 ↗ 9.5 ↘
 beste Teiler 115.6 (24.) 214.5 (26.) 266.8 (28.)
 Trefferlage 0.13 mm rechts, 2.39 mm hoch
 Streuwert 2.63, horizontal: 2.89, vertikal: 2.35

Unterschrift des Schützen

Ergebnis: **309.5** (296)
 Serien: 101.5 104.1 103.9
 Zähler: 26 4 0 0 0 0 0 0 0 0
 Innenzehner: 23
 weiteste: 472 (1), 385 (28), 361 (10)
 beste Teiler 16.0 (24.) 34.0 (19.) 41.4 (30.)
 Trefferlage 0.36 mm links, 0.77 mm hoch
 Streuwert 1.23, horizontal: 1.54, vertikal: 0.80

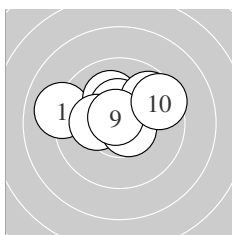
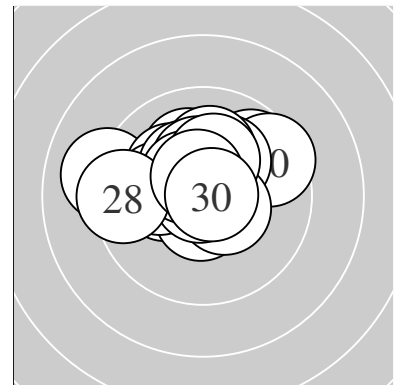

Serie 1:
 9.1 ← 10.6 * 10.1 ↗ 10.5 * 10.4 *
 9.8 ↗ 10.2 * 10.6 * 10.7 * 9.5 ↗
 beste Teiler 56.8 (9.) 84.3 (8.) 91.3 (2.)
 Trefferlage 0.13 mm links, 0.92 mm hoch
 Streuwert 1.64, horizontal: 2.17, vertikal: 0.82

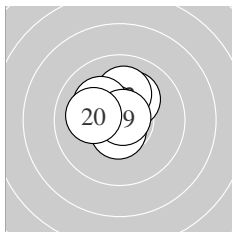

Serie 2:
 10.2 * 10.1 ↑ 10.5 * 10.8 * 10.6 *
 10.2 * 10.6 * 10.2 * 10.8 * 10.1 ←
 beste Teiler 34.0 (19.) 50.1 (14.) 77.7 (15.)
 Trefferlage 0.57 mm links, 0.67 mm hoch
 Streuwert 0.92, horizontal: 0.99, vertikal: 0.85

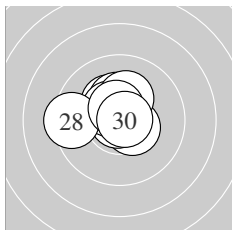

Serie 3:
 10.3 * 10.5 * 10.4 * 10.9 * 10.3 *
 10.5 * 10.2 * 9.4 ← 10.6 * 10.8 *
 beste Teiler 16.0 (24.) 41.4 (30.) 99.0 (29.)
 Trefferlage 0.39 mm links, 0.72 mm hoch
 Streuwert 1.11, horizontal: 1.35, vertikal: 0.81

Unterschrift des Schützen

Ergebnis: **306.5** (295)
 Serien: 102.3 103.1 101.1
 Zähler: 25 5 0 0 0 0 0 0 0 0
 Innenzehner: 19
 weiteste: 313 (27), 278 (10), 273 (9)
 beste Teiler 73.2 (2.) 96.5 (20.) 102.0 (4.)
 Trefferlage 0.28 mm links, 0.14 mm hoch
 Streuwert 1.36, horizontal: 1.41, vertikal: 1.31

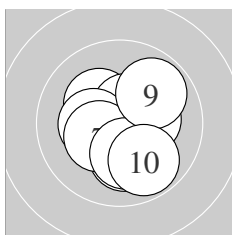
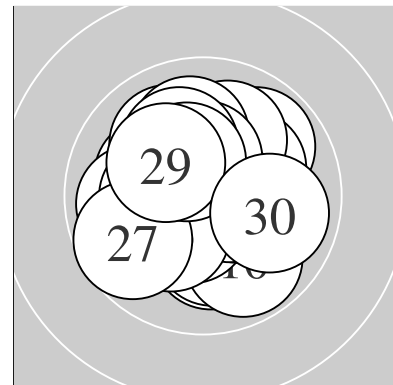

Serie 1:
 10.2 * 10.7 * 10.3 * 10.5 * 10.1 ↓
 10.3 * 10.3 * 10.2 * 9.9 ↗ 9.8 ↘
 beste Teiler 73.2 (2.) 102.0 (4.) 152.5 (7.)
 Trefferlage 0.26 mm rechts, 0.34 mm tief
 Streuwert 1.37, horizontal: 1.29, vertikal: 1.45

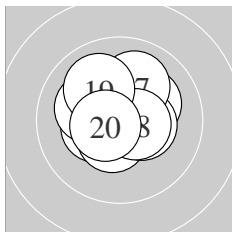

Serie 2:
 10.5 * 10.3 * 10.2 * 10.5 * 10.4 *
 10.1 ↖ 10.0 ↗ 10.5 * 10.0 ↘ 10.6 *
 beste Teiler 96.5 (20.) 103.3 (18.) 115.5 (14.)
 Trefferlage 0.21 mm links, 0.36 mm hoch
 Streuwert 1.20, horizontal: 1.32, vertikal: 1.07

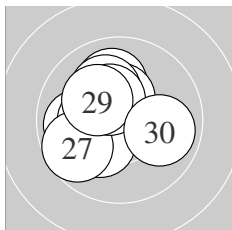

Serie 3:
 9.9 ← 10.0 ↑ 10.4 * 10.3 * 10.2 *
 10.1 ↘ 9.7 ↖ 10.4 * 10.2 * 9.9 →
 beste Teiler 136.0 (23.) 143.1 (28.) 169.0 (24.)
 Trefferlage 0.90 mm links, 0.40 mm hoch
 Streuwert 1.43, horizontal: 1.48, vertikal: 1.39

Unterschrift des Schützen

Ergebnis: **307.7** (296)
 Serien: 101.4 102.9 103.4
 Zähler: 26 4 0 0 0 0 0 0 0 0
 Innenzehner: 22
 weiteste: 409 (4), 304 (24), 292 (20)
 beste Teiler 8.2 (15.) 60.4 (26.) 62.9 (12.)
 Trefferlage 0.62 mm rechts, 0.45 mm tief
 Streuwert 1.27, horizontal: 1.38, vertikal: 1.16

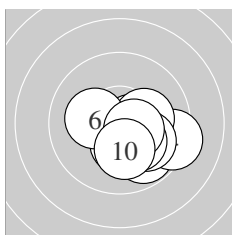
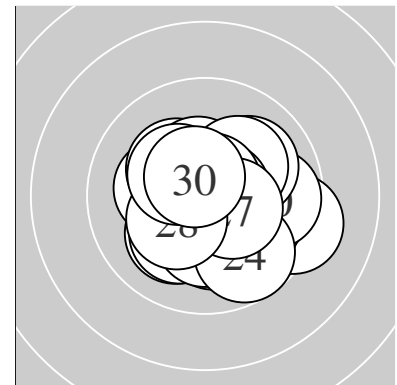

Serie 1:
 10.6 * 9.8 ↘ 10.4 * 9.3 → 10.2 *
 10.2 * 10.0 ↘ 10.2 * 10.5 * 10.2 *
 beste Teiler 86.7 (1.) 115.5 (9.) 150.0 (3.)
 Trefferlage 1.12 mm rechts, 0.94 mm tief
 Streuwert 1.23, horizontal: 1.48, vertikal: 0.91

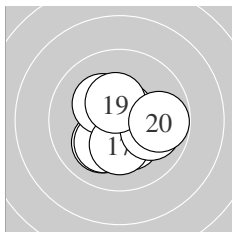

Serie 2:
 10.1 ↙ 10.7 * 10.2 * 10.3 * 10.9 *
 10.3 * 10.2 * 10.0 → 10.4 * 9.8 →
 beste Teiler 8.2 (15.) 62.9 (12.) 131.7 (19.)
 Trefferlage 0.22 mm rechts, 0.43 mm tief
 Streuwert 1.32, horizontal: 1.44, vertikal: 1.20

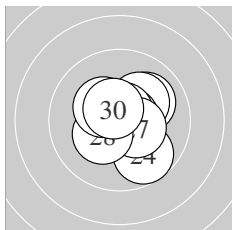

Serie 3:
 10.5 * 10.0 ↗ 10.2 * 9.7 ↘ 10.7 *
 10.7 * 10.4 * 10.3 * 10.3 * 10.6 *
 beste Teiler 60.4 (26.) 68.1 (25.) 97.1 (30.)
 Trefferlage 0.52 mm rechts, 0.02 mm hoch
 Streuwert 1.20, horizontal: 1.16, vertikal: 1.23

Unterschrift des Schützen

Ergebnis: **287.3** (273)
 Serien: 94.7 98.0 94.6
 Zähler: 11 13 4 2 0 0 0 0 0 0
 Innenzehner: 8
 weiteste: 919 (2), 773 (25), 731 (21)
 beste Teiler 34.7 (24.) 45.8 (17.) 52.7 (19.)
 Trefferlage 1.54 mm links, 2.15 mm hoch
 Streuwert 2.18, horizontal: 2.83, vertikal: 1.22

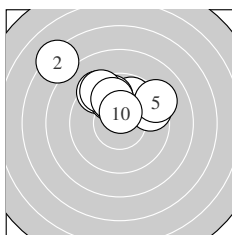
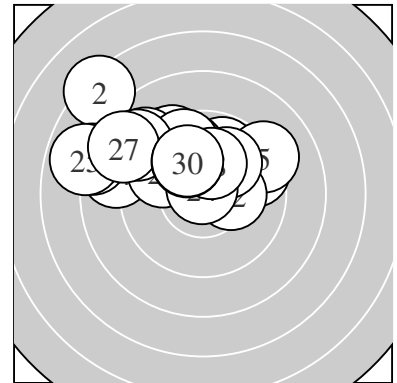

Serie 1:
 9.8 ↗ 7.3 ↘ 9.5 ↗ 9.4 ↘ 9.2 ↗
 9.9 ↘ 9.8 ↗ 9.4 ↘ 9.9 ↗ 10.5 *
 beste Teiler 118.5 (10.) 264.5 (6.) 266.6 (9.)
 Trefferlage 0.49 mm links, 2.84 mm hoch
 Streuwert 2.32, horizontal: 2.94, vertikal: 1.45

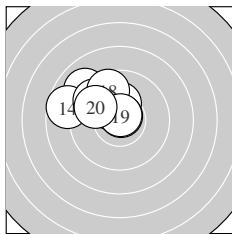

Serie 2:
 9.3 ↘ 9.0 ↘ 10.3 * 8.7 ↖ 9.6 ↘
 10.2 * 10.8 * 9.6 ↘ 10.7 * 9.8 ↘
 beste Teiler 45.8 (17.) 52.7 (19.) 164.6 (13.)
 Trefferlage 1.95 mm links, 1.74 mm hoch
 Streuwert 1.49, horizontal: 1.88, vertikal: 0.95

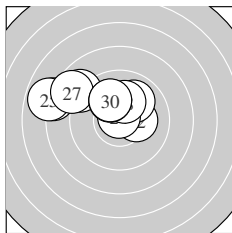

Serie 3:
 8.0 ↖ 10.2 * 10.0 ↗ 10.8 * 7.9 ↖
 8.9 ↘ 8.6 ↘ 10.2 * 10.0 ↘ 10.0 ↘
 beste Teiler 34.7 (24.) 176.0 (22.) 198.6 (28.)
 Trefferlage 2.18 mm links, 1.87 mm hoch
 Streuwert 2.52, horizontal: 3.43, vertikal: 0.99

Unterschrift des Schützen

Ergebnis: **306.1** (291)
 Serien: 102.6 101.8 101.7
 Zähler: 21 9 0 0 0 0 0 0 0 0
 Innenzehner: 17
 weiteste: 433 (30), 328 (13), 322 (14)
 beste Teiler 33.0 (17.) 53.0 (24.) 68.1 (28.)
 Trefferlage 0.17 mm rechts, 0.30 mm hoch
 Streuwert 1.48, horizontal: 1.37, vertikal: 1.57

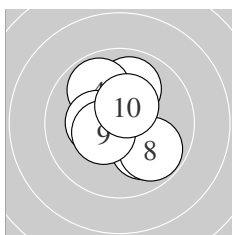
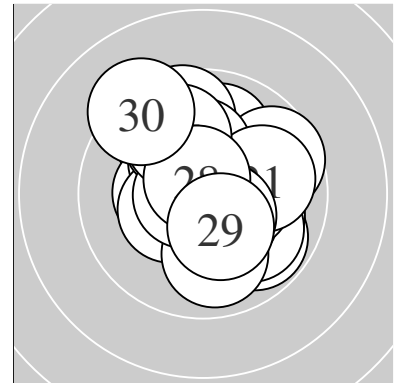

Serie 1:
 10.6 * 10.6 * 10.0 ↑ 9.9 ↘ 10.6 *
 10.3 * 10.0 ↘ 9.8 ↘ 10.4 * 10.4 *
 beste Teiler 76.0 (5.) 76.4 (2.) 94.9 (1.)
 Trefferlage 0.11 mm rechts, 0.05 mm hoch
 Streuwert 1.39, horizontal: 1.28, vertikal: 1.50

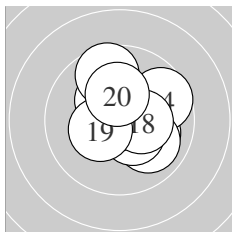

Serie 2:
 10.1 ↘ 10.3 * 9.6 ↑ 9.7 ↗ 10.0 ↘
 10.4 * 10.8 * 10.3 * 10.4 * 10.2 *
 beste Teiler 33.0 (17.) 131.5 (16.) 149.8 (19.)
 Trefferlage 0.57 mm rechts, 0.38 mm hoch
 Streuwert 1.49, horizontal: 1.49, vertikal: 1.49

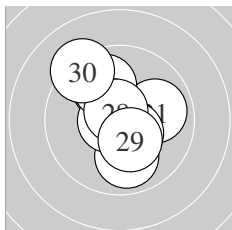

Serie 3:
 9.9 → 10.5 * 9.9 ↓ 10.7 * 9.9 ↘
 10.7 * 9.9 ↘ 10.7 * 10.3 * 9.2 ↘
 beste Teiler 53.0 (24.) 68.1 (28.) 71.1 (26.)
 Trefferlage 0.15 mm links, 0.49 mm hoch
 Streuwert 1.63, horizontal: 1.39, vertikal: 1.84

Unterschrift des Schützen

Ergebnis: **304.6** (294)
 Serien: 100.5 100.7 103.4
 Zähler: 24 6 0 0 0 0 0 0 0 0
 Innenzehner: 17
 weiteste: 456 (16), 412 (2), 354 (7)
 beste Teiler 21.9 (24.) 28.0 (18.) 39.6 (22.)
 Trefferlage 0.76 mm links, 0.74 mm tief
 Streuwert 1.41, horizontal: 1.60, vertikal: 1.18

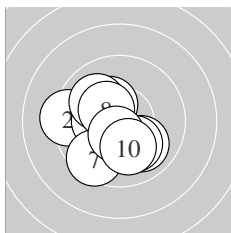
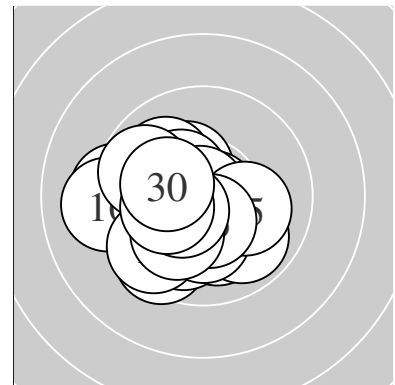

Serie 1:
 10.3 * 9.3 ← 10.3 * 10.0 ↘ 10.0 ↘
 10.1 ↘ 9.5 ↙ 10.4 * 10.5 * 10.1 ↘
 beste Teiler 108.4 (9.) 141.0 (8.) 155.2 (1.)
 Trefferlage 0.80 mm links, 0.55 mm tief
 Streuwert 1.65, horizontal: 1.73, vertikal: 1.57

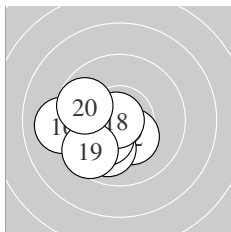

Serie 2:
 10.4 * 10.3 * 10.2 * 10.0 ↙ 10.3 *
 9.1 ← 10.2 * 10.8 * 9.6 ↙ 9.8 ↖
 beste Teiler 28.0 (18.) 126.3 (11.) 160.0 (12.)
 Trefferlage 1.37 mm links, 0.88 mm tief
 Streuwert 1.38, horizontal: 1.61, vertikal: 1.09

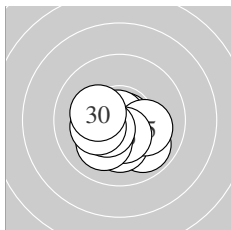

Serie 3:
 9.9 ↘ 10.8 * 10.2 * 10.9 * 10.1 →
 10.5 * 10.1 ↙ 10.5 * 10.2 * 10.2 *
 beste Teiler 21.9 (24.) 39.6 (22.) 122.6 (28.)
 Trefferlage 0.12 mm links, 0.80 mm tief
 Streuwert 1.13, horizontal: 1.33, vertikal: 0.88

Unterschrift des Schützen

Ergebnis: **293.4** (280)
 Serien: 95.9 96.5 101.0
 Zähler: 16 10 3 0 1 0 0 0 0 0
 Innenzehner: 11
 weiteste: 1055 (5), 630 (11), 540 (3)
 beste Teiler 46.8 (8.) 55.0 (28.) 67.0 (22.)
 Trefferlage 0.44 mm rechts, 0.11 mm tief
 Streuwert 2.56, horizontal: 2.91, vertikal: 2.14

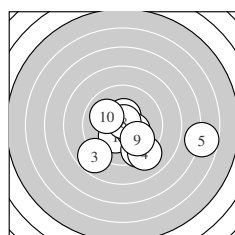
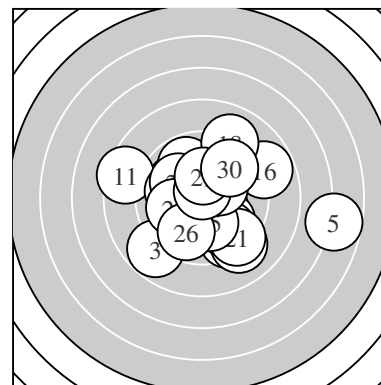

Serie 1:
 10.3 * 9.4 ↘ 8.8 ↙ 9.1 ↘ 6.7 →
 10.5 * 10.4 * 10.8 * 9.9 ↘ 10.0 ↖
 beste Teiler 46.8 (8.) 125.0 (6.) 150.3 (7.)
 Trefferlage 1.22 mm rechts, 1.37 mm tief
 Streuwert 3.00, horizontal: 3.79, vertikal: 1.92

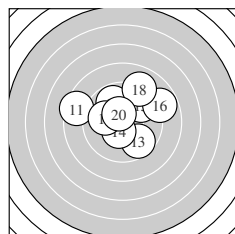

Serie 2:
 8.4 ↖ 10.3 * 9.7 ↘ 10.4 * 9.6 ↗
 8.8 ↗ 9.8 ↘ 9.0 ↗ 10.0 ↖ 10.5 *
 beste Teiler 118.7 (20.) 129.0 (14.) 156.4 (12.)
 Trefferlage 0.00 mm , 1.22 mm hoch
 Streuwert 2.55, horizontal: 3.04, vertikal: 1.94

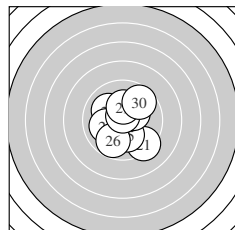

Serie 3:
 9.3 ↘ 10.7 * 10.1 ↖ 10.0 ↖ 10.1 ↘
 9.8 ↙ 10.3 * 10.7 * 10.3 * 9.7 ↗
 beste Teiler 55.0 (28.) 67.0 (22.) 162.2 (27.)
 Trefferlage 0.10 mm rechts, 0.18 mm tief
 Streuwert 1.77, horizontal: 1.65, vertikal: 1.88

Unterschrift des Schützen

Meyton Elektronik

Ergebnis: **309.8** (294)
 Serien: 102.6 104.1 103.1
 Zähler: 24 6 0 0 0 0 0 0 0 0
 Innenzehner: 23
 weiteste: 372 (30), 305 (26), 286 (5)
 beste Teiler 7.6 (18.) 26.9 (16.) 48.0 (28.)
 Trefferlage 0.40 mm links, 0.02 mm hoch
 Streuwert 1.26, horizontal: 1.32, vertikal: 1.19

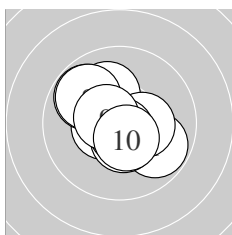
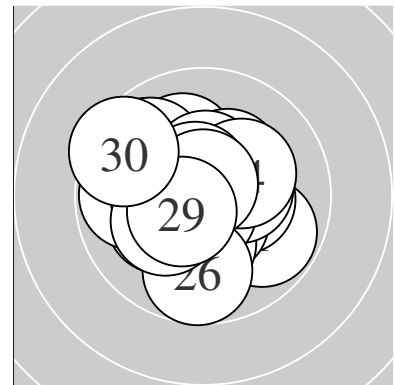

Serie 1:
 9.8 ↘ 10.1 ↗ 10.3 * 10.5 * 9.8 ↗
 10.5 * 10.7 * 9.8 ↘ 10.6 * 10.5 *
 beste Teiler 54.1 (7.) 98.0 (9.) 108.6 (4.)
 Trefferlage 0.24 mm links, 0.13 mm hoch
 Streuwert 1.40, horizontal: 1.50, vertikal: 1.29

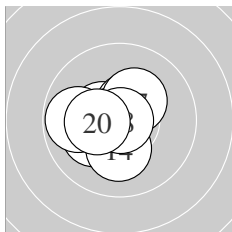

Serie 2:
 10.2 * 10.5 * 10.6 * 10.2 * 10.5 *
 10.8 * 10.3 * 10.9 * 9.8 ← 10.3 *
 beste Teiler 7.6 (18.) 26.9 (16.) 86.5 (13.)
 Trefferlage 0.64 mm links, 0.09 mm tief
 Streuwert 1.06, horizontal: 1.17, vertikal: 0.94

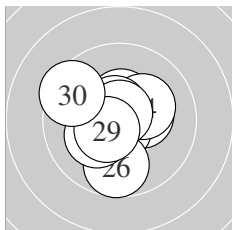

Serie 3:
 10.4 * 10.7 * 10.5 * 10.2 * 10.6 *
 9.7 ↓ 10.2 * 10.8 * 10.5 * 9.5 ↗
 beste Teiler 48.0 (28.) 60.2 (22.) 85.6 (25.)
 Trefferlage 0.31 mm links, 0.02 mm hoch
 Streuwert 1.40, horizontal: 1.39, vertikal: 1.41

Unterschrift des Schützen

Ergebnis: **303.0** (290)
 Serien: 100.2 101.2 101.6
 Zähler: 20 10 0 0 0 0 0 0 0 0
 Innenzehner: 15
 weiteste: 378 (10), 375 (2), 373 (11)
 beste Teiler 59.2 (25.) 69.0 (30.) 89.6 (28.)
 Trefferlage 0.13 mm links, 0.02 mm tief
 Streuwert 1.67, horizontal: 1.68, vertikal: 1.67

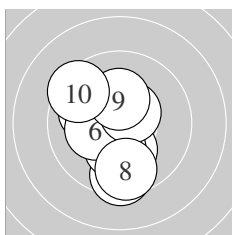
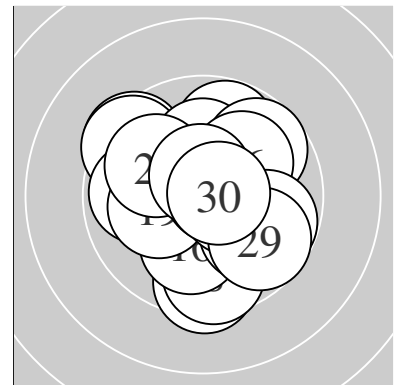

Serie 1:
 10.2 * 9.5 ↓ 10.0 ↖ 10.2 * 10.3 *
 10.2 * 10.5 * 9.6 ↓ 10.3 * 9.4 ↗
 beste Teiler 109.6 (7.) 169.7 (5.) 174.0 (9.)
 Trefferlage 0.72 mm links, 0.53 mm tief
 Streuwert 1.75, horizontal: 1.32, vertikal: 2.09

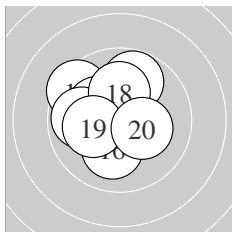

Serie 2:
 9.5 ↖ 10.6 * 10.2 * 9.8 ↑ 10.5 *
 10.1 ↓ 9.9 ← 10.1 ↑ 10.2 * 10.3 *
 beste Teiler 100.1 (12.) 119.9 (15.) 173.6 (20.)
 Trefferlage 0.83 mm links, 0.34 mm hoch
 Streuwert 1.55, horizontal: 1.54, vertikal: 1.56

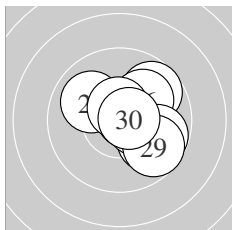

Serie 3:
 10.0 ↖ 9.9 ↘ 9.7 ↗ 10.4 * 10.7 *
 10.1 ↗ 9.8 ↘ 10.6 * 9.7 ↘ 10.7 *
 beste Teiler 59.2 (25.) 69.0 (30.) 89.6 (28.)
 Trefferlage 1.16 mm rechts, 0.11 mm hoch
 Streuwert 1.39, horizontal: 1.46, vertikal: 1.33

Unterschrift des Schützen

Ergebnis: **293.4** (280)
 Serien: 98.0 96.6 98.8
 Zähler: 12 16 2 0 0 0 0 0 0 0
 Innenzehner: 11
 weiteste: 608 (10), 527 (30), 493 (12)
 beste Teiler 43.0 (25.) 79.0 (17.) 118.6 (6.)
 Trefferlage 0.32 mm links, 0.81 mm tief
 Streuwert 2.26, horizontal: 2.79, vertikal: 1.55

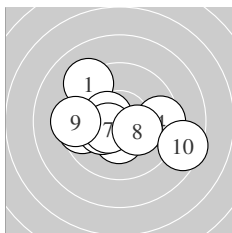
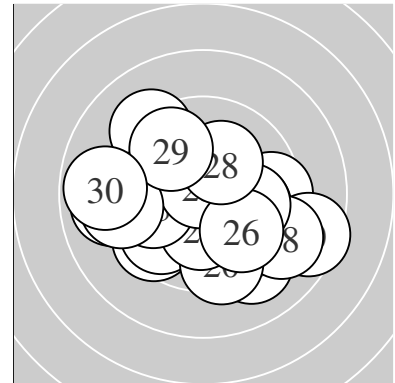

Serie 1:
 9.2 ↘ 10.3 * 9.6 ← 9.5 → 10.3 *
 10.5 * 10.5 * 10.2 * 9.4 ← 8.5 →
 beste Teiler 118.6 (6.) 119.3 (7.) 156.1 (2.)
 Trefferlage 0.29 mm links, 0.27 mm tief
 Streuwert 2.43, horizontal: 3.10, vertikal: 1.49

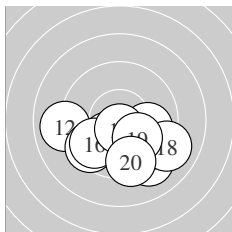

Serie 2:
 9.9 → 9.0 ← 9.2 ↘ 10.2 * 9.5 ↙
 9.7 ↙ 10.6 * 9.0 → 10.1 ↘ 9.4 ↓
 beste Teiler 79.0 (17.) 186.4 (14.) 224.1 (19.)
 Trefferlage 0.10 mm rechts, 1.93 mm tief
 Streuwert 2.15, horizontal: 2.82, vertikal: 1.14

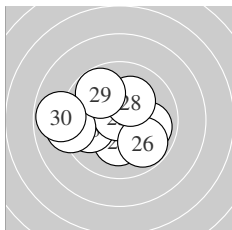

Serie 3:
 10.3 * 10.2 * 9.8 ← 9.9 → 10.8 *
 9.8 ↘ 9.2 ← 10.2 * 9.8 ↘ 8.8 ←
 beste Teiler 43.0 (25.) 172.2 (21.) 185.3 (22.)
 Trefferlage 0.78 mm links, 0.23 mm tief
 Streuwert 2.14, horizontal: 2.66, vertikal: 1.45

Unterschrift des Schützen

Ergebnis: **304.3** (292)
 Serien: 101.8 101.3 101.2
 Zähler: 23 6 1 0 0 0 0 0 0 0
 Innenzehner: 14
 weiteste: 564 (26), 418 (29), 409 (5)
 beste Teiler 41.5 (17.) 49.4 (30.) 86.5 (10.)
 Trefferlage 0.77 mm links, 0.23 mm tief
 Streuwert 1.57, horizontal: 1.52, vertikal: 1.61

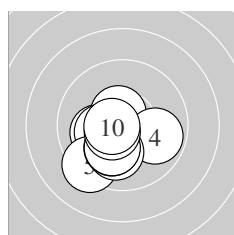
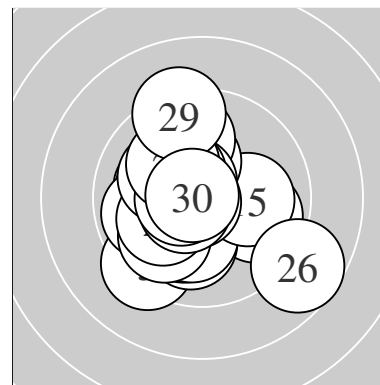

Serie 1:
 10.1 ← 10.6 * 10.3 * 9.9 → 9.3 ↙
 10.1 ↓ 10.1 ↘ 10.2 * 10.6 * 10.6 *
 beste Teiler 86.5 (10.) 98.4 (2.) 99.0 (9.)
 Trefferlage 0.79 mm links, 1.06 mm tief
 Streuwert 1.28, horizontal: 1.38, vertikal: 1.17

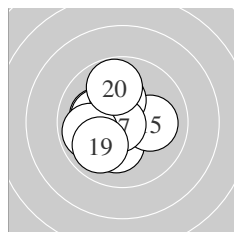

Serie 2:
 10.1 ↙ 10.1 ← 10.2 * 10.2 * 10.1 →
 10.2 * 10.8 * 9.9 ← 9.9 ↘ 9.8 ↑
 beste Teiler 41.5 (17.) 179.6 (16.) 188.7 (13.)
 Trefferlage 0.98 mm links, 0.02 mm tief
 Streuwert 1.43, horizontal: 1.38, vertikal: 1.48

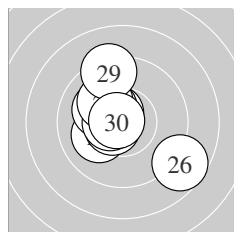

Serie 3:
 10.1 ↙ 10.1 ↖ 10.6 * 10.3 * 10.6 *
 8.7 ↘ 10.6 * 10.1 ↗ 9.3 ↑ 10.8 *
 beste Teiler 49.4 (30.) 91.6 (25.) 92.0 (23.)
 Trefferlage 0.55 mm links, 0.38 mm hoch
 Streuwert 1.88, horizontal: 1.87, vertikal: 1.89

Unterschrift des Schützen

Meyton Elektronik

Ergebnis: **287.6** (275)
 Serien: 97.8 96.5 93.3
 Zähler: 11 14 4 1 0 0 0 0 0 0
 Innenzehner: 10
 weiteste: 848 (28), 706 (18), 650 (3)
 beste Teiler 19.2 (12.) 49.0 (17.) 91.0 (27.)
 Trefferlage 0.32 mm links, 0.11 mm hoch
 Streuwert 2.83, horizontal: 2.46, vertikal: 3.15

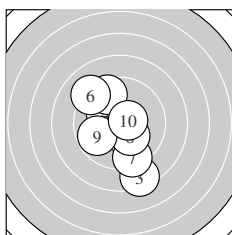
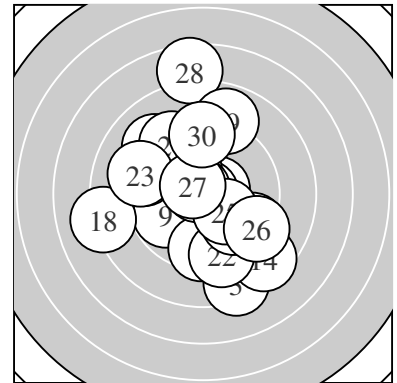

Serie 1:
 10.5 * 10.3 * 8.4 ↓ 10.2 * 9.5 ↗
 9.1 ↘ 9.3 ↓ 10.2 * 9.8 ← 10.5 *
 beste Teiler 101.1 (10.) 101.4 (1.) 155.4 (2.)
 Trefferlage 0.41 mm links, 0.51 mm tief
 Streuwert 2.46, horizontal: 1.87, vertikal: 2.94

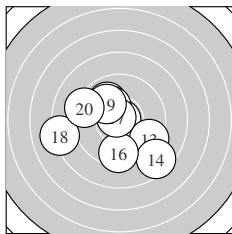

Serie 2:
 9.9 ↘ 10.9 * 9.4 ↘ 8.5 ↘ 10.2 *
 9.5 ↓ 10.8 * 8.1 ← 10.0 ↘ 9.2 ↖
 beste Teiler 19.2 (12.) 49.0 (17.) 188.3 (15.)
 Trefferlage 0.75 mm links, 0.47 mm tief
 Streuwert 2.82, horizontal: 3.18, vertikal: 2.39

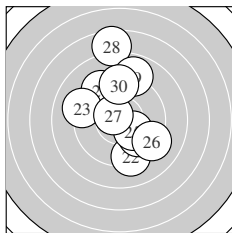

Serie 3:
 9.3 ↘ 9.2 ↓ 9.2 ↖ 9.8 ↘ 10.2 *
 9.2 ↘ 10.6 * 7.6 ↑ 8.9 ↑ 9.3 ↑
 beste Teiler 91.0 (27.) 195.8 (25.) 285.2 (24.)
 Trefferlage 0.20 mm rechts, 1.31 mm hoch
 Streuwert 3.21, horizontal: 2.32, vertikal: 3.90

Unterschrift des Schützen

Ergebnis: **311.4** (297)
 Serien: 103.8 103.6 104.0
 Zähler: 27 3 0 0 0 0 0 0 0 0
 Innenzehner: 23
 weiteste: 303 (30), 259 (28), 255 (6)
 beste Teiler 30.0 (19.) 43.2 (22.) 47.8 (24.)
 Trefferlage 0.45 mm links, 0.45 mm hoch
 Streuwert 1.05, horizontal: 1.22, vertikal: 0.85

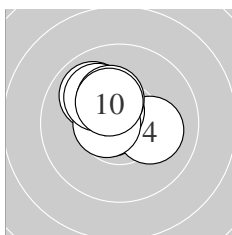
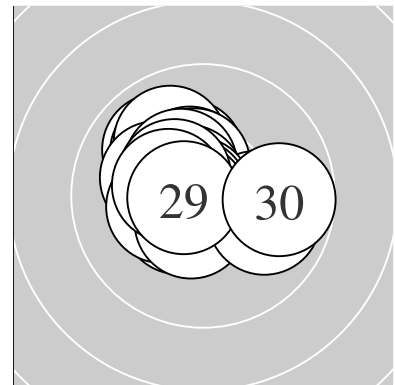

Serie 1:
 10.7 * 10.7 * 10.5 * 10.1 → 10.6 *
 9.9 ↖ 10.6 * 10.1 ↖ 10.3 * 10.3 *
 beste Teiler 60.1 (2.) 64.3 (1.) 85.0 (7.)
 Trefferlage 0.58 mm links, 0.80 mm hoch
 Streuwert 0.91, horizontal: 1.00, vertikal: 0.81

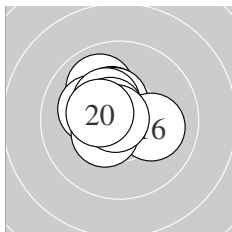

Serie 2:
 10.0 ↖ 10.2 * 10.4 * 10.4 * 10.3 *
 10.1 → 10.6 * 10.4 * 10.8 * 10.4 *
 beste Teiler 30.0 (19.) 85.5 (17.) 129.4 (14.)
 Trefferlage 0.60 mm links, 0.64 mm hoch
 Streuwert 0.99, horizontal: 1.07, vertikal: 0.89

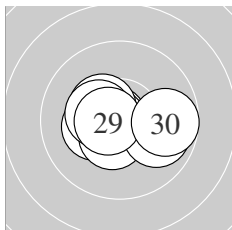

Serie 3:
 10.6 * 10.8 * 10.3 * 10.8 * 10.4 *
 10.5 * 10.4 * 9.9 → 10.6 * 9.7 →
 beste Teiler 43.2 (22.) 47.8 (24.) 77.3 (29.)
 Trefferlage 0.17 mm links, 0.10 mm tief
 Streuwert 1.19, horizontal: 1.59, vertikal: 0.58

Unterschrift des Schützen

Ergebnis: **305.6** (292)
 Serien: 102.3 101.0 102.3
 Zähler: 22 8 0 0 0 0 0 0 0 0
 Innenzehner: 16
 weiteste: 431 (19), 353 (1), 353 (11)
 beste Teiler 26.2 (13.) 50.1 (22.) 64.8 (28.)
 Trefferlage 0.42 mm links, 0.49 mm hoch
 Streuwert 1.50, horizontal: 1.47, vertikal: 1.53

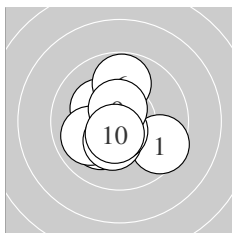
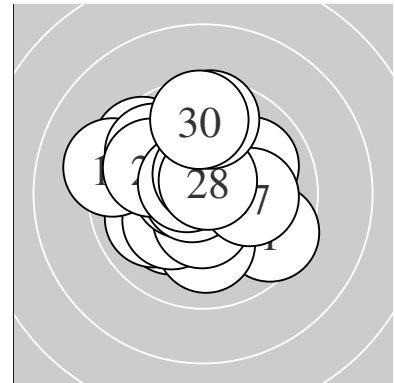

Serie 1:
 9.5 ↘ 10.6 * 10.2 * 10.1 ✓ 10.0 ←
 9.8 ↑ 10.3 * 10.7 * 10.6 * 10.5 *
 beste Teiler 74.6 (8.) 87.7 (2.) 95.0 (9.)
 Trefferlage 0.34 mm links, 0.19 mm tief
 Streuwert 1.46, horizontal: 1.42, vertikal: 1.51

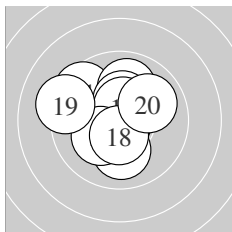

Serie 2:
 9.5 ↘ 10.0 ↑ 10.8 * 10.0 ↓ 10.3 *
 10.5 * 10.2 * 10.5 * 9.2 ↖ 10.0 →
 beste Teiler 26.2 (13.) 107.2 (16.) 115.1 (18.)
 Trefferlage 0.49 mm links, 0.48 mm hoch
 Streuwert 1.70, horizontal: 1.81, vertikal: 1.59

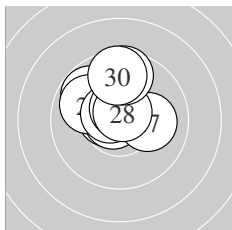

Serie 3:
 10.6 * 10.8 * 9.8 ↘ 9.9 ↖ 10.6 *
 10.6 * 10.1 → 10.7 * 9.6 ↑ 9.6 ↑
 beste Teiler 50.1 (22.) 64.8 (28.) 88.4 (25.)
 Trefferlage 0.43 mm links, 1.20 mm hoch
 Streuwert 1.29, horizontal: 1.29, vertikal: 1.30

Unterschrift des Schützen

Ergebnis: **295.4** (280)
 Serien: 98.2 97.6 99.6
 Zähler: 13 14 3 0 0 0 0 0 0 0
 Innenzehner: 8
 weiteste: 555 (11), 540 (3), 510 (28)
 beste Teiler 43.5 (9.) 62.9 (17.) 85.7 (8.)
 Trefferlage 0.76 mm links, 0.36 mm hoch
 Streuwert 2.14, horizontal: 2.39, vertikal: 1.85

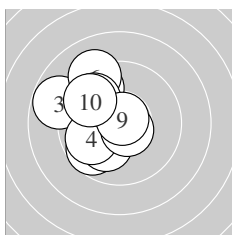
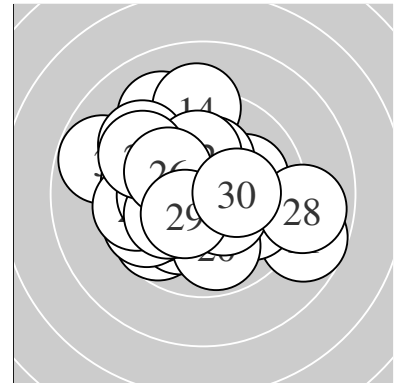

Serie 1:
 9.7 ↙ 10.1 ↙ 8.8 ↖ 9.9 ↙ 9.6 ↖
 9.2 ↘ 9.8 ↘ 10.6 * 10.8 * 9.7 ↘
 beste Teiler 43.5 (9.) 85.7 (8.) 216.9 (2.)
 Trefferlage 1.86 mm links, 0.71 mm hoch
 Streuwert 1.87, horizontal: 1.59, vertikal: 2.12

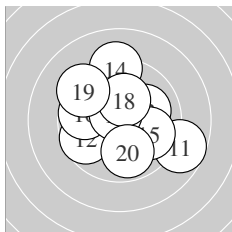

Serie 2:
 8.7 → 9.7 ↙ 10.1 → 9.2 ↑ 9.9 →
 9.7 ← 10.7 * 10.3 * 9.4 ↘ 9.9 ↓
 beste Teiler 62.9 (17.) 175.1 (18.) 225.6 (13.)
 Trefferlage 0.11 mm rechts, 0.31 mm hoch
 Streuwert 2.45, horizontal: 2.66, vertikal: 2.21

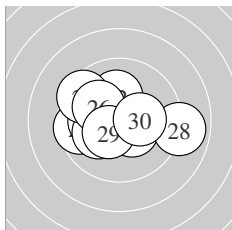

Serie 3:
 9.6 ← 10.2 * 10.1 ← 10.1 ↙ 9.5 ↖
 10.1 ↘ 10.4 * 8.9 → 10.4 * 10.3 *
 beste Teiler 137.3 (29.) 137.7 (27.) 171.1 (30.)
 Trefferlage 0.55 mm links, 0.07 mm hoch
 Streuwert 2.00, horizontal: 2.56, vertikal: 1.20

Unterschrift des Schützen

Ergebnis: **284.3** (270)
 Serien: 94.1 94.2 96.0
 Zähler: 8 16 5 0 1 0 0 0 0 0
 Innenzehner: 8
 weiteste: 1081 (4), 728 (8), 671 (23)
 beste Teiler 95.8 (22.) 119.0 (1.) 127.0 (3.)
 Trefferlage 1.41 mm links, 0.14 mm tief
 Streuwert 2.88, horizontal: 3.10, vertikal: 2.63

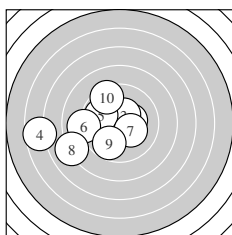
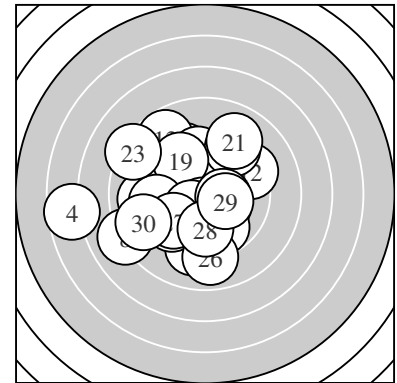

Serie 1:
 10.5 * 10.3 * 10.4 * 6.6 ← 9.9 ↖
 9.0 ← 10.2 * 8.0 ↙ 9.8 ↘ 9.4 ↗
 beste Teiler 119.0 (1.) 127.0 (3.) 154.7 (2.)
 Trefferlage 2.46 mm links, 0.38 mm tief
 Streuwert 3.09, horizontal: 3.87, vertikal: 2.01

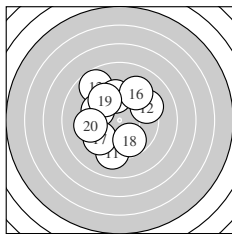

Serie 2:
 9.2 ↓ 9.3 ↗ 8.7 ↘ 9.7 ↑ 9.7 ↖
 9.3 ↗ 9.5 ↙ 9.8 ↓ 9.6 ↘ 9.4 ←
 beste Teiler 297.3 (18.) 319.7 (15.) 322.8 (14.)
 Trefferlage 0.90 mm links, 0.70 mm hoch
 Streuwert 2.80, horizontal: 2.54, vertikal: 3.04

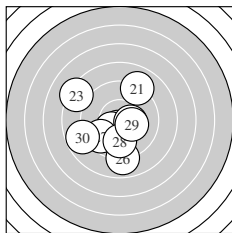

Serie 3:
 9.0 ↗ 10.6 * 8.3 ↖ 10.3 * 10.4 *
 8.9 ↓ 9.6 ↙ 9.8 ↓ 10.3 * 8.8 ←
 beste Teiler 95.8 (22.) 147.8 (25.) 158.4 (24.)
 Trefferlage 0.87 mm links, 0.75 mm tief
 Streuwert 2.78, horizontal: 2.77, vertikal: 2.79

Unterschrift des Schützen

Ergebnis: **301.0** (286)
 Serien: 101.8 99.5 99.7
 Zähler: 17 12 1 0 0 0 0 0 0 0
 Innenzehner: 13
 weiteste: 607 (22), 446 (12), 404 (3)
 beste Teiler 51.6 (29.) 78.0 (1.) 83.7 (6.)
 Trefferlage 0.56 mm links, 0.42 mm tief
 Streuwert 1.81, horizontal: 1.93, vertikal: 1.68

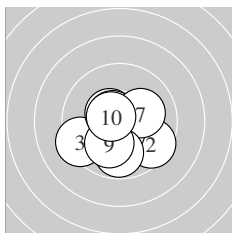
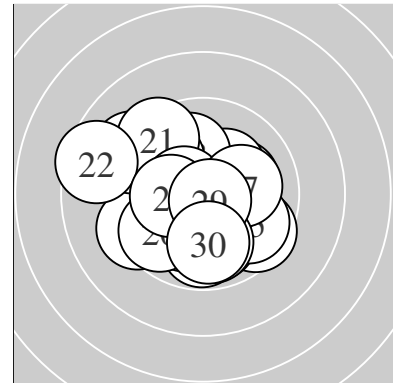

Serie 1:
 10.6 * 9.6 ↘ 9.3 ↙ 10.5 * 10.6 *
 10.6 * 10.1 → 9.8 ↓ 10.1 ↙ 10.6 *
 beste Teiler 78.0 (1.) 83.7 (6.) 88.5 (10.)
 Trefferlage 0.13 mm links, 0.73 mm tief
 Streuwert 1.58, horizontal: 1.76, vertikal: 1.37

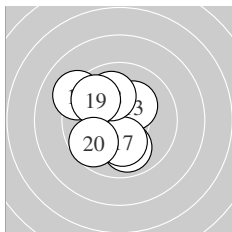

Serie 2:
 10.4 * 9.2 ↖ 10.2 * 9.9 ↓ 9.9 ↙
 10.2 * 10.2 * 10.0 ↖ 9.8 ↖ 9.7 ↙
 beste Teiler 140.8 (11.) 179.0 (13.) 196.8 (17.)
 Trefferlage 1.10 mm links, 0.32 mm tief
 Streuwert 1.77, horizontal: 1.55, vertikal: 1.97

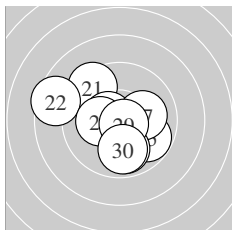

Serie 3:
 9.4 ↖ 8.5 ↖ 10.5 * 10.3 * 9.8 ↘
 10.6 * 10.1 → 9.9 ↓ 10.7 * 9.9 ↓
 beste Teiler 51.6 (29.) 93.4 (26.) 109.7 (23.)
 Trefferlage 0.45 mm links, 0.21 mm tief
 Streuwert 2.14, horizontal: 2.44, vertikal: 1.78

Unterschrift des Schützen

Ergebnis: **309.3** (295)
 Serien: 100.7 103.6 105.0
 Zähler: 25 5 0 0 0 0 0 0 0 0
 Innenzehner: 24
 weiteste: 339 (9), 283 (1), 272 (8)
 beste Teiler 41.2 (21.) 76.0 (28.) 76.9 (25.)
 Trefferlage 0.21 mm rechts, 0.35 mm hoch
 Streuwert 1.22, horizontal: 1.30, vertikal: 1.12

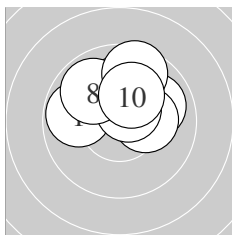
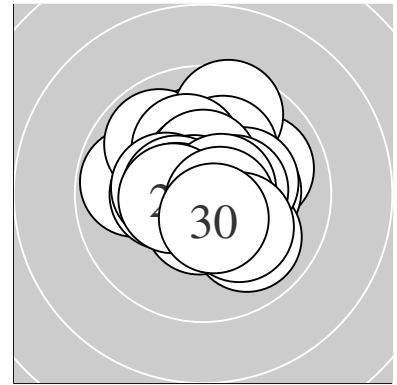

Serie 1:
 9.8 ← 10.3 * 10.2 * 9.9 → 10.1 ↑
 10.2 * 10.5 * 9.9 ↘ 9.6 ↑ 10.2 *
 beste Teiler 101.6 (7.) 154.3 (2.) 177.2 (6.)
 Trefferlage 0.50 mm rechts, 1.29 mm hoch
 Streuwert 1.36, horizontal: 1.65, vertikal: 0.98

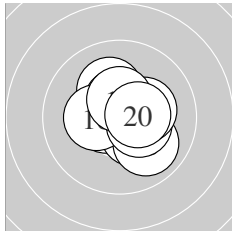

Serie 2:
 10.2 * 10.6 * 10.5 * 10.4 * 9.9 ↘
 10.3 * 10.4 * 10.3 * 10.5 * 10.5 *
 beste Teiler 93.3 (12.) 104.7 (13.) 120.0 (19.)
 Trefferlage 0.35 mm rechts, 0.11 mm hoch
 Streuwert 1.14, horizontal: 1.19, vertikal: 1.09

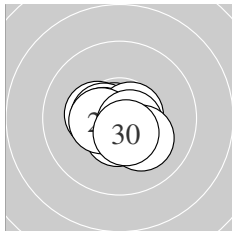

Serie 3:
 10.8 * 10.3 * 10.5 * 10.5 * 10.6 *
 10.5 * 10.5 * 10.6 * 10.2 * 10.5 *
 beste Teiler 41.2 (21.) 76.0 (28.) 76.9 (25.)
 Trefferlage 0.21 mm links, 0.33 mm tief
 Streuwert 0.83, horizontal: 1.01, vertikal: 0.59

Unterschrift des Schützen

Ergebnis: **310.3** (298)
 Serien: 104.4 102.3 103.6
 Zähler: 28 2 0 0 0 0 0 0 0 0
 Innenzehner: 23
 weiteste: 381 (17), 263 (25), 249 (5)
 beste Teiler 42.9 (27.) 65.1 (24.) 74.6 (10.)
 Trefferlage 0.05 mm links, 0.34 mm hoch
 Streuwert 1.21, horizontal: 1.29, vertikal: 1.12

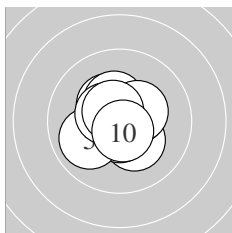
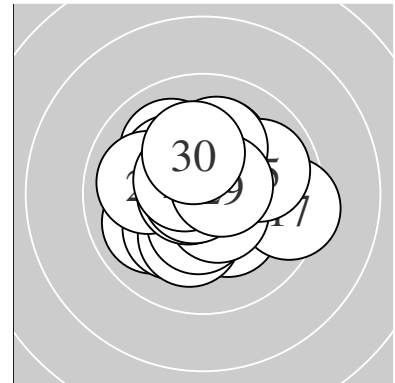

Serie 1:
 10.3 * 10.5 * 10.6 * 10.4 * 10.0 ↙
 10.4 * 10.4 * 10.5 * 10.6 * 10.7 *
 beste Teiler 74.6 (10.) 78.0 (3.) 87.9 (9.)
 Trefferlage 0.12 mm links, 0.10 mm hoch
 Streuwert 1.07, horizontal: 1.10, vertikal: 1.03

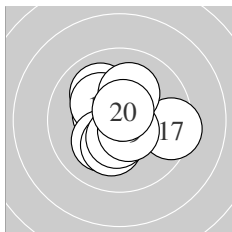

Serie 2:
 10.5 * 10.0 ↖ 10.2 * 10.2 * 10.2 *
 10.4 * 9.4 → 10.1 ↑ 10.6 * 10.7 *
 beste Teiler 75.2 (20.) 99.3 (19.) 124.6 (11.)
 Trefferlage 0.06 mm links, 0.01 mm hoch
 Streuwert 1.49, horizontal: 1.57, vertikal: 1.40

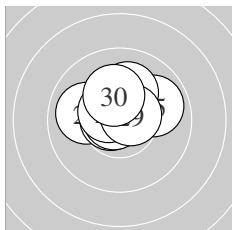

Serie 3:
 10.2 * 10.5 * 10.0 ← 10.7 * 9.9 →
 10.1 ↑ 10.8 * 10.6 * 10.6 * 10.2 *
 beste Teiler 42.9 (27.) 65.1 (24.) 89.4 (29.)
 Trefferlage 0.02 mm rechts, 0.90 mm hoch
 Streuwert 1.04, horizontal: 1.29, vertikal: 0.72

Unterschrift des Schützen

Ergebnis: **307.8** (295)
 Serien: 102.1 102.4 103.3
 Zähler: 25 5 0 0 0 0 0 0 0 0
 Innenzehner: 20
 weiteste: 483 (9), 361 (8), 316 (28)
 beste Teiler 43.0 (4.) 68.5 (24.) 71.0 (16.)
 Trefferlage 0.34 mm rechts, 0.22 mm tief
 Streuwert 1.39, horizontal: 1.10, vertikal: 1.64

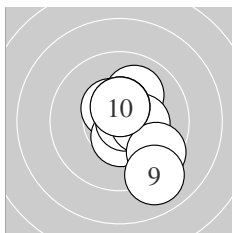
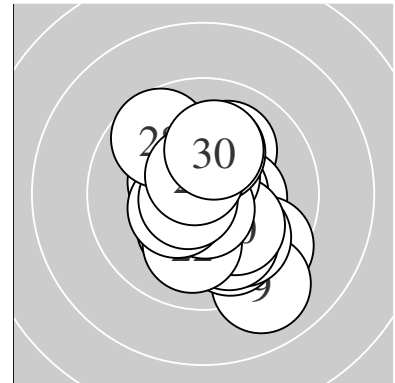

Serie 1:
 10.5 * 10.4 * 10.5 * 10.8 * 10.1 ↗
 10.3 * 10.5 * 9.5 ↘ 9.0 ↘ 10.5 *
 beste Teiler 43.0 (4.) 108.0 (10.) 110.1 (7.)
 Trefferlage 0.89 mm rechts, 0.18 mm tief
 Streuwert 1.54, horizontal: 1.14, vertikal: 1.86

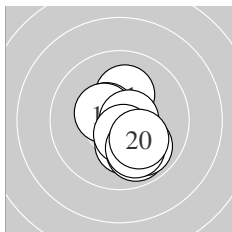

Serie 2:
 10.2 * 10.2 * 10.5 * 10.4 * 9.9 ↘
 10.7 * 9.9 ↘ 10.5 * 10.0 ↘ 10.1 ↘
 beste Teiler 71.0 (16.) 109.6 (18.) 114.7 (13.)
 Trefferlage 0.52 mm rechts, 0.76 mm tief
 Streuwert 1.23, horizontal: 0.98, vertikal: 1.45

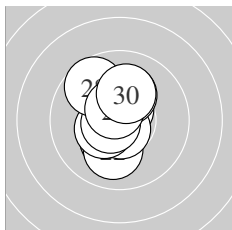

Serie 3:
 10.3 * 10.0 ↓ 10.6 * 10.7 * 10.4 *
 10.2 * 10.7 * 9.7 ↖ 10.6 * 10.1 ↑
 beste Teiler 68.5 (24.) 72.4 (27.) 86.5 (23.)
 Trefferlage 0.39 mm links, 0.27 mm hoch
 Streuwert 1.25, horizontal: 0.79, vertikal: 1.58

Unterschrift des Schützen

Meyton Elektronik

Ergebnis: **309.9** (299)
 Serien: 104.6 102.7 102.6
 Zähler: 29 1 0 0 0 0 0 0 0 0
 Innenzehner: 21
 weiteste: 267 (23), 248 (11), 225 (12)
 beste Teiler 55.5 (30.) 72.2 (13.) 75.5 (3.)
 Trefferlage 0.02 mm rechts, 0.41 mm hoch
 Streuwert 1.15, horizontal: 1.23, vertikal: 1.06

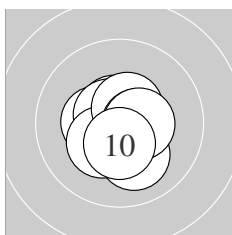
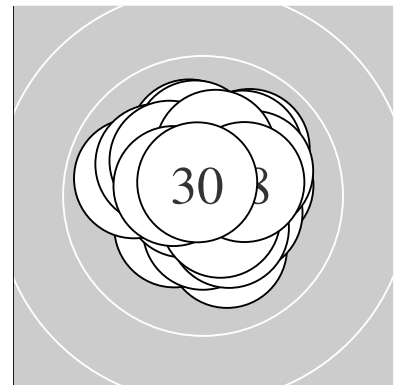

Serie 1:
 10.4 * 10.6 * 10.7 * 10.1 ↘ 10.6 *
 10.3 * 10.5 * 10.5 * 10.5 * 10.4 *
 beste Teiler 75.5 (3.) 82.3 (2.) 83.2 (5.)
 Trefferlage 0.00 mm , 0.30 mm tief
 Streuwert 0.93, horizontal: 0.91, vertikal: 0.95

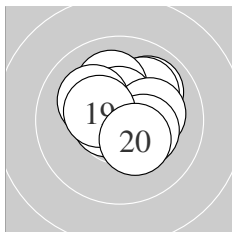

Serie 2:
 10.0 ↗ 10.1 ↗ 10.7 * 10.1 ↑ 10.5 *
 10.2 * 10.1 ↘ 10.3 * 10.4 * 10.3 *
 beste Teiler 72.2 (13.) 111.0 (15.) 137.4 (19.)
 Trefferlage 0.33 mm rechts, 0.69 mm hoch
 Streuwert 1.21, horizontal: 1.33, vertikal: 1.09

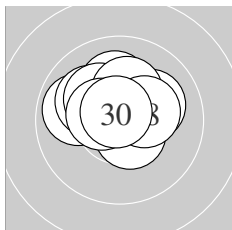

Serie 3:
 10.1 ↑ 10.1 ↗ 9.9 ← 10.5 * 10.1 ↘
 10.2 * 10.2 * 10.3 * 10.5 * 10.7 *
 beste Teiler 55.5 (30.) 104.6 (24.) 117.0 (29.)
 Trefferlage 0.27 mm links, 0.85 mm hoch
 Streuwert 1.17, horizontal: 1.44, vertikal: 0.81

Unterschrift des Schützen

Ergebnis: **301.9** (288)
 Serien: 101.5 100.7 99.7
 Zähler: 19 10 1 0 0 0 0 0 0 0
 Innenzehner: 11
 weiteste: 582 (23), 337 (28), 315 (7)
 beste Teiler 42.0 (15.) 75.3 (8.) 81.6 (1.)
 Trefferlage 0.03 mm links, 0.61 mm tief
 Streuwert 1.72, horizontal: 2.01, vertikal: 1.36

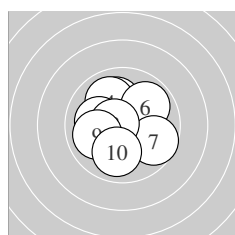
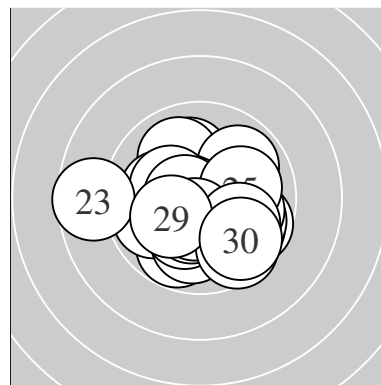

Serie 1:
 10.6 * 10.1 ↗ 10.4 * 10.0 ↖ 10.1 ←
 9.9 ↘ 9.7 ↘ 10.7 * 10.0 ← 10.0 ↓
 beste Teiler 75.3 (8.) 81.6 (1.) 136.8 (3.)
 Trefferlage 0.20 mm links, 0.29 mm hoch
 Streuwert 1.61, horizontal: 1.70, vertikal: 1.51

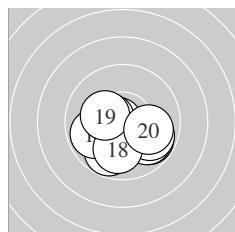

Serie 2:
 9.8 ↘ 9.8 ↓ 9.8 ↘ 9.9 ← 10.8 *
 9.8 ↘ 10.5 * 10.0 ↓ 10.3 * 10.0 →
 beste Teiler 42.0 (15.) 123.7 (17.) 171.2 (19.)
 Trefferlage 0.20 mm rechts, 1.03 mm tief
 Streuwert 1.59, horizontal: 1.95, vertikal: 1.11

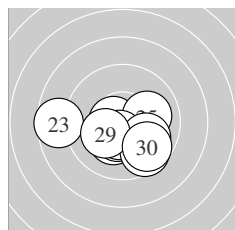

Serie 3:
 10.2 * 10.6 * 8.6 ← 10.4 * 10.0 →
 10.5 * 9.9 ↘ 9.6 ↘ 10.2 * 9.7 ↘
 beste Teiler 83.4 (22.) 120.3 (26.) 140.7 (24.)
 Trefferlage 0.12 mm links, 1.09 mm tief
 Streuwert 1.91, horizontal: 2.50, vertikal: 1.03

Unterschrift des Schützen

Meyton Elektronik

Ergebnis: **307.0** (294)
 Serien: 102.2 102.3 102.5
 Zähler: 24 6 0 0 0 0 0 0 0 0
 Innenzehner: 19
 weiteste: 361 (3), 341 (16), 331 (11)
 beste Teiler 51.6 (28.) 54.0 (1.) 78.2 (26.)
 Trefferlage 0.58 mm links, 0.09 mm hoch
 Streuwert 1.37, horizontal: 1.53, vertikal: 1.19

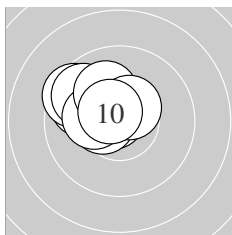
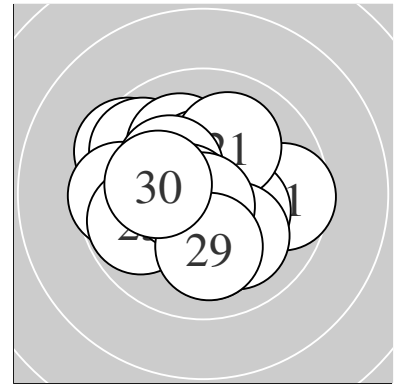

Serie 1:
 10.7 * 9.8 ↖ 9.5 ↖ 10.5 * 9.7 ↖
 10.6 * 10.2 * 10.1 ↖ 10.5 * 10.6 *
 beste Teiler 54.0 (1.) 93.1 (6.) 94.0 (10.)
 Trefferlage 1.30 mm links, 0.96 mm hoch
 Streuwert 0.97, horizontal: 1.18, vertikal: 0.70

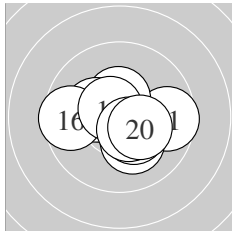

Serie 2:
 9.6 → 10.4 * 10.4 * 10.2 * 10.3 *
 9.6 ← 10.6 * 10.4 * 10.5 * 10.3 *
 beste Teiler 87.7 (17.) 106.4 (19.) 128.3 (13.)
 Trefferlage 0.01 mm rechts, 0.16 mm tief
 Streuwert 1.48, horizontal: 1.88, vertikal: 0.92

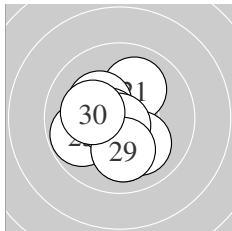

Serie 3:
 10.1 ↗ 10.5 * 9.8 ↙ 10.1 ↓ 10.3 *
 10.6 * 10.1 ↘ 10.7 * 10.1 ↓ 10.2 *
 beste Teiler 51.6 (28.) 78.2 (26.) 110.3 (22.)
 Trefferlage 0.46 mm links, 0.52 mm tief
 Streuwert 1.33, horizontal: 1.27, vertikal: 1.39

Unterschrift des Schützen

Ergebnis: **307.9** (295)
 Serien: 101.2 102.1 104.6
 Zähler: 25 5 0 0 0 0 0 0 0 0
 Innenzehner: 17
 weiteste: 293 (7), 293 (8), 281 (2)
 beste Teiler 35.0 (30.) 58.6 (15.) 59.0 (23.)
 Trefferlage 0.07 mm rechts, 0.43 mm hoch
 Streuwert 1.31, horizontal: 1.34, vertikal: 1.29

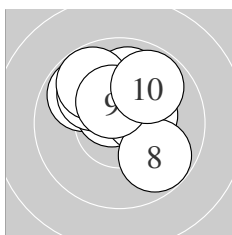
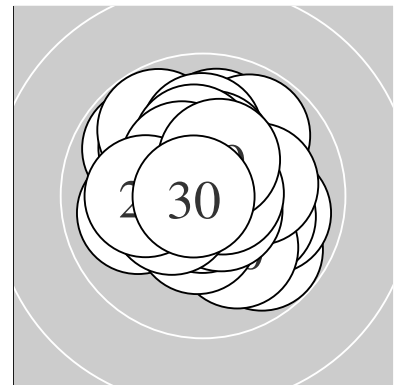

Serie 1:
 10.6 * 9.8 ↘ 10.0 ↑ 10.6 * 10.0 ↘
 10.4 * 9.8 ↘ 9.8 ↘ 10.4 * 9.8 ↗
 beste Teiler 91.9 (4.) 93.6 (1.) 139.4 (9.)
 Trefferlage 0.03 mm links, 1.21 mm hoch
 Streuwert 1.41, horizontal: 1.50, vertikal: 1.32

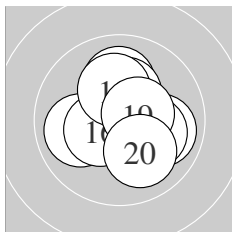

Serie 2:
 9.9 → 10.0 ↑ 10.0 ← 10.3 * 10.7 *
 10.4 * 10.1 → 10.2 * 10.5 * 10.0 ↘
 beste Teiler 58.6 (15.) 118.9 (19.) 132.8 (16.)
 Trefferlage 0.32 mm rechts, 0.10 mm hoch
 Streuwert 1.41, horizontal: 1.45, vertikal: 1.38

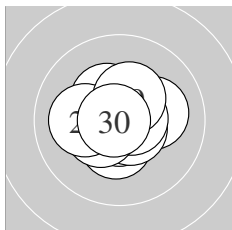

Serie 3:
 10.4 * 10.4 * 10.7 * 10.1 → 10.6 *
 10.7 * 10.4 * 10.1 ← 10.4 * 10.8 *
 beste Teiler 35.0 (30.) 59.0 (23.) 73.5 (26.)
 Trefferlage 0.06 mm links, 0.00 mm
 Streuwert 1.01, horizontal: 1.15, vertikal: 0.85

 Unterschrift des Schützen

Ergebnis: **313.6** (298)
 Serien: 105.0 104.1 104.5
 Zähler: 28 2 0 0 0 0 0 0 0 0
 Innenzehner: 27
 weiteste: 271 (16), 263 (18), 201 (2)
 beste Teiler 15.8 (6.) 23.3 (7.) 30.6 (3.)
 Trefferlage 0.02 mm links, 0.16 mm hoch
 Streuwert 1.02, horizontal: 1.02, vertikal: 1.01

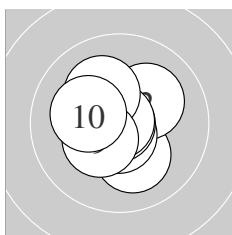
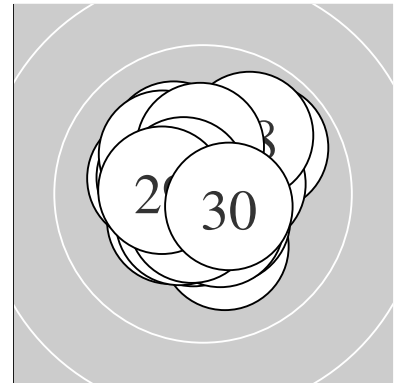

Serie 1:
 10.2 * 10.1 ↗ 10.8 * 10.6 * 10.7 *
 10.9 * 10.9 * 10.2 * 10.4 * 10.2 *
 beste Teiler 15.8 (6.) 23.3 (7.) 30.6 (3.)
 Trefferlage 0.28 mm links, 0.06 mm tief
 Streuwert 1.01, horizontal: 0.96, vertikal: 1.06

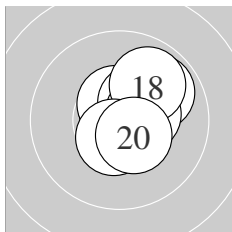

Serie 2:
 10.7 * 10.7 * 10.5 * 10.6 * 10.4 *
 9.9 ↗ 10.4 * 9.9 ↗ 10.5 * 10.5 *
 beste Teiler 57.0 (12.) 57.7 (11.) 99.4 (14.)
 Trefferlage 0.71 mm rechts, 0.40 mm hoch
 Streuwert 0.97, horizontal: 0.89, vertikal: 1.05

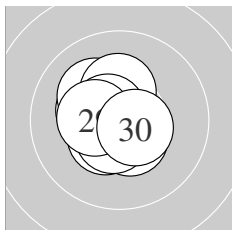

Serie 3:
 10.5 * 10.3 * 10.4 * 10.6 * 10.2 *
 10.7 * 10.3 * 10.6 * 10.4 * 10.5 *
 beste Teiler 75.5 (26.) 82.9 (28.) 97.1 (24.)
 Trefferlage 0.51 mm links, 0.16 mm hoch
 Streuwert 0.91, horizontal: 0.84, vertikal: 0.98

Unterschrift des Schützen

Ergebnis: **310.9** (298)
 Serien: 103.1 104.4 103.4
 Zähler: 28 2 0 0 0 0 0 0 0 0
 Innenzehner: 24
 weiteste: 304 (7), 270 (27), 227 (30)
 beste Teiler 4.0 (3.) 37.0 (15.) 39.0 (29.)
 Trefferlage 0.01 mm links, 0.17 mm tief
 Streuwert 1.16, horizontal: 1.19, vertikal: 1.11

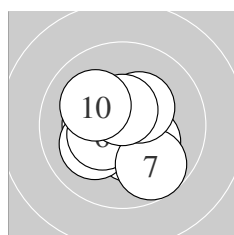
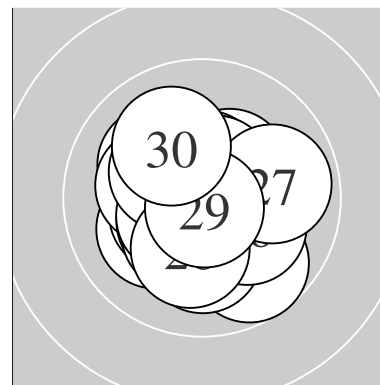

Serie 1:
 10.3 * 10.4 * 10.9 * 10.1 ↙ 10.3 *
 10.4 * 9.7 ↘ 10.3 * 10.6 * 10.1 ↖
 beste Teiler 4.0 (3.) 96.0 (9.) 139.6 (6.)
 Trefferlage 0.15 mm links, 0.32 mm tief
 Streuwert 1.28, horizontal: 1.35, vertikal: 1.22

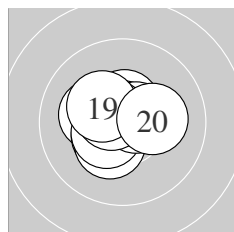

Serie 2:
 10.2 * 10.4 * 10.5 * 10.3 * 10.8 *
 10.5 * 10.6 * 10.6 * 10.3 * 10.2 *
 beste Teiler 37.0 (15.) 84.3 (18.) 88.8 (17.)
 Trefferlage 0.37 mm links, 0.09 mm hoch
 Streuwert 0.96, horizontal: 1.10, vertikal: 0.79

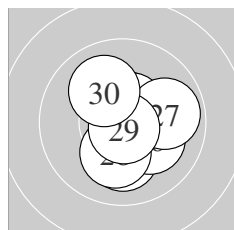

Serie 3:
 10.6 * 10.6 * 10.1 ↓ 10.5 * 10.5 *
 10.2 * 9.9 → 10.2 * 10.8 * 10.0 ↘
 beste Teiler 39.0 (29.) 95.5 (21.) 99.8 (22.)
 Trefferlage 0.48 mm rechts, 0.30 mm tief
 Streuwert 1.20, horizontal: 1.07, vertikal: 1.33

Unterschrift des Schützen

Ergebnis: **307.2** (295)
 Serien: 102.6 102.8 101.8
 Zähler: 25 5 0 0 0 0 0 0 0 0
 Innenzehner: 18
 weiteste: 317 (7), 312 (22), 308 (25)
 beste Teiler 43.1 (23.) 48.5 (12.) 59.5 (13.)
 Trefferlage 1.09 mm links, 0.09 mm tief
 Streuwert 1.15, horizontal: 1.30, vertikal: 0.98

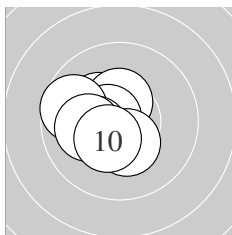
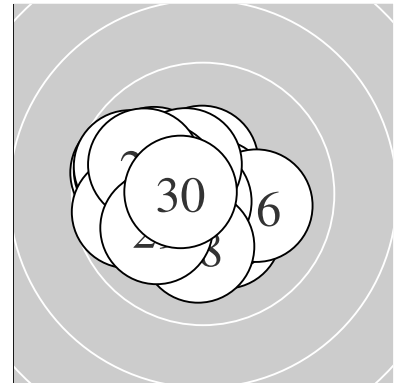

Serie 1:
 10.4 * 10.0 ← 10.3 * 10.4 * 10.6 *
 10.4 * 9.7 ← 10.3 * 10.1 ← 10.4 *
 beste Teiler 80.5 (5.) 128.0 (4.) 128.4 (1.)
 Trefferlage 1.22 mm links, 0.10 mm tief
 Streuwert 1.02, horizontal: 1.08, vertikal: 0.97

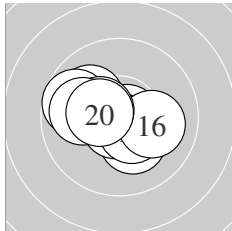

Serie 2:
 10.2 * 10.8 * 10.7 * 10.5 * 10.0 ↖
 10.1 → 9.7 ← 10.4 * 10.0 ← 10.4 *
 beste Teiler 48.5 (12.) 59.5 (13.) 116.6 (14.)
 Trefferlage 0.59 mm links, 0.01 mm tief
 Streuwert 1.31, horizontal: 1.65, vertikal: 0.85

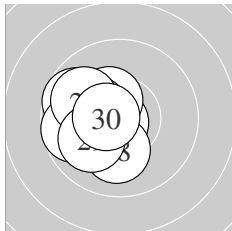

Serie 3:
 10.3 * 9.7 ↖ 10.8 * 10.4 * 9.7 ←
 10.3 * 9.9 ↖ 10.1 ↓ 10.0 ↙ 10.6 *
 beste Teiler 43.1 (23.) 90.3 (30.) 137.2 (24.)
 Trefferlage 1.46 mm links, 0.17 mm tief
 Streuwert 1.12, horizontal: 1.04, vertikal: 1.19

 Unterschrift des Schützen

Ergebnis: **310.9** (298)
 Serien: 103.1 103.7 104.1
 Zähler: 28 2 0 0 0 0 0 0 0 0
 Innenzehner: 23
 weiteste: 298 (11), 257 (28), 229 (7)
 beste Teiler 35.8 (26.) 40.1 (1.) 42.9 (13.)
 Trefferlage 0.16 mm links, 0.20 mm hoch
 Streuwert 1.15, horizontal: 1.34, vertikal: 0.93

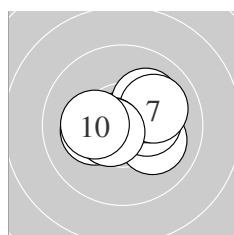
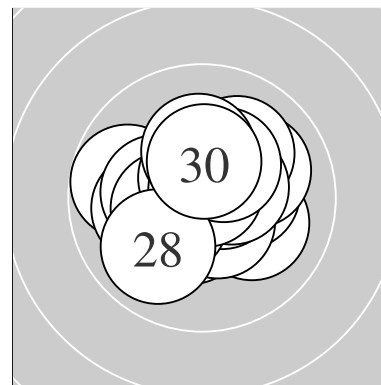

Serie 1:
 10.8 * 10.2 * 10.1 ↘ 10.3 * 10.2 *
 10.1 ↗ 10.0 ↗ 10.6 * 10.6 * 10.2 *
 beste Teiler 40.1 (1.) 90.9 (9.) 93.9 (8.)
 Trefferlage 0.30 mm rechts, 0.16 mm hoch
 Streuwert 1.26, horizontal: 1.58, vertikal: 0.80

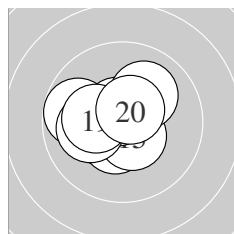

Serie 2:
 9.8 ← 10.4 * 10.8 * 10.5 * 10.5 *
 10.6 * 10.1 ← 10.1 ↗ 10.3 * 10.6 *
 beste Teiler 42.9 (13.) 77.3 (16.) 95.1 (20.)
 Trefferlage 0.63 mm links, 0.13 mm hoch
 Streuwert 1.14, horizontal: 1.33, vertikal: 0.90

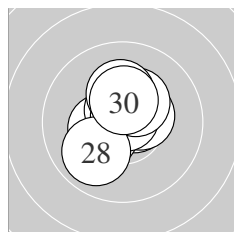

Serie 3:
 10.6 * 10.4 * 10.5 * 10.4 * 10.6 *
 10.8 * 10.3 * 9.9 ↙ 10.2 * 10.4 *
 beste Teiler 35.8 (26.) 80.6 (21.) 83.1 (25.)
 Trefferlage 0.16 mm links, 0.32 mm hoch
 Streuwert 1.06, horizontal: 0.99, vertikal: 1.13

Unterschrift des Schützen

Meyton Elektronik

Ergebnis: **309.9** (297)
 Serien: 103.9 102.0 104.0
 Zähler: 27 3 0 0 0 0 0 0 0 0
 Innenzehner: 22
 weiteste: 274 (13), 264 (12), 260 (1)
 beste Teiler 38.6 (6.) 51.9 (23.) 75.9 (28.)
 Trefferlage 0.12 mm rechts, 0.04 mm tief
 Streuwert 1.21, horizontal: 1.19, vertikal: 1.22

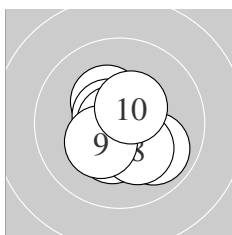
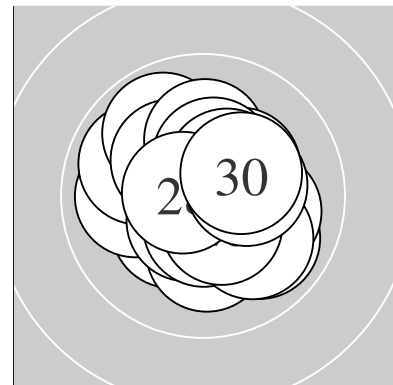

Serie 1:
 9.9 ↘ 10.3 * 10.5 * 10.5 * 10.6 *
 10.8 * 10.3 * 10.2 * 10.3 * 10.5 *
 beste Teiler 38.6 (6.) 82.6 (5.) 105.6 (3.)
 Trefferlage 0.06 mm rechts, 0.50 mm tief
 Streuwert 1.06, horizontal: 1.00, vertikal: 1.10

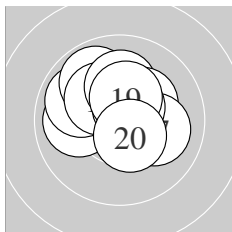

Serie 2:
 10.0 ← 9.9 ↖ 9.9 ↗ 10.2 * 10.1 ↑
 10.3 * 10.1 → 10.6 * 10.4 * 10.5 *
 beste Teiler 97.0 (18.) 115.3 (20.) 144.1 (19.)
 Trefferlage 0.23 mm links, 0.85 mm hoch
 Streuwert 1.34, horizontal: 1.56, vertikal: 1.07

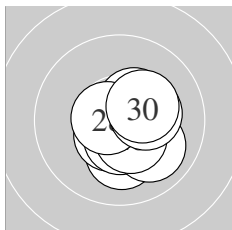

Serie 3:
 10.1 ↓ 10.5 * 10.7 * 10.5 * 10.0 ↘
 10.5 * 10.4 * 10.7 * 10.3 * 10.3 *
 beste Teiler 51.9 (23.) 75.9 (28.) 107.9 (22.)
 Trefferlage 0.53 mm rechts, 0.48 mm tief
 Streuwert 0.96, horizontal: 0.90, vertikal: 1.03

Unterschrift des Schützen

Ergebnis: **310.0** (296)
 Serien: 104.1 102.6 103.3
 Zähler: 26 4 0 0 0 0 0 0 0 0
 Innenzehner: 25
 weiteste: 376 (14), 344 (4), 302 (18)
 beste Teiler 26.6 (16.) 31.2 (8.) 35.1 (6.)
 Trefferlage 0.47 mm links, 0.19 mm hoch
 Streuwert 1.21, horizontal: 1.28, vertikal: 1.14

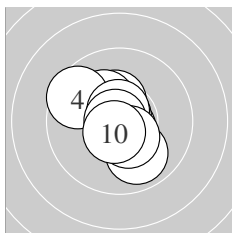
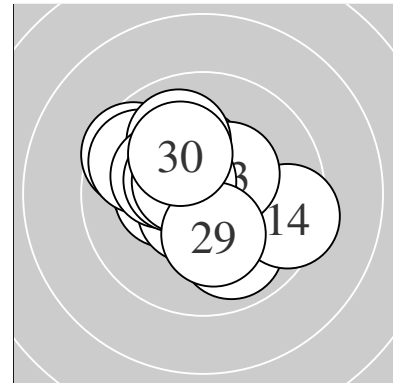

Serie 1:
 10.4 * 10.7 * 10.2 * 9.6 ↖ 9.9 ↘
 10.8 * 10.7 * 10.8 * 10.4 * 10.6 *
 beste Teiler 31.2 (8.) 35.1 (6.) 60.8 (2.)
 Trefferlage 0.30 mm links, 0.10 mm hoch
 Streuwert 1.22, horizontal: 1.14, vertikal: 1.29

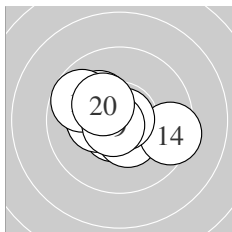

Serie 2:
 10.2 * 10.6 * 10.4 * 9.4 → 10.2 *
 10.8 * 10.3 * 9.7 ↖ 10.7 * 10.3 *
 beste Teiler 26.6 (16.) 57.6 (19.) 85.0 (12.)
 Trefferlage 0.50 mm links, 0.10 mm hoch
 Streuwert 1.41, horizontal: 1.76, vertikal: 0.94

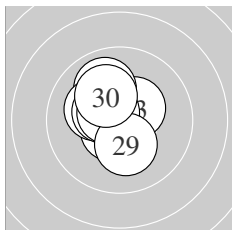

Serie 3:
 10.3 * 10.4 * 10.4 * 10.0 ↗ 10.6 *
 10.2 * 10.4 * 10.6 * 10.2 * 10.2 *
 beste Teiler 91.0 (25.) 97.6 (28.) 127.0 (22.)
 Trefferlage 0.62 mm links, 0.38 mm hoch
 Streuwert 1.10, horizontal: 0.90, vertikal: 1.26

Unterschrift des Schützen

Ergebnis: **309.7** (295)
 Serien: 102.6 103.7 103.4
 Zähler: 25 5 0 0 0 0 0 0 0 0
 Innenzehner: 21
 weiteste: 278 (12), 275 (18), 269 (8)
 beste Teiler 38.2 (11.) 43.6 (2.) 45.0 (17.)
 Trefferlage 0.42 mm rechts, 0.22 mm tief
 Streuwert 1.20, horizontal: 1.27, vertikal: 1.13

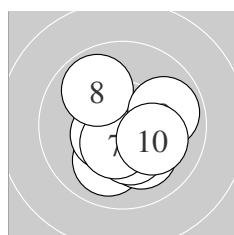
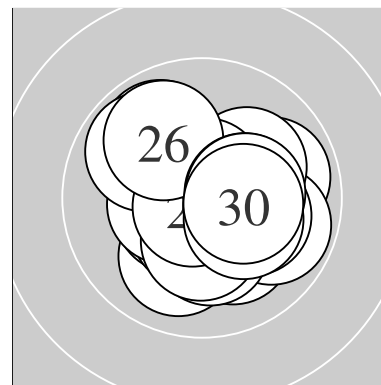

Serie 1:
 10.0 ↙ 10.8 * 10.5 * 10.1 ↘ 10.3 *
 10.5 * 10.5 * 9.9 ↘ 9.9 → 10.1 ↘
 beste Teiler 43.6 (2.) 111.3 (3.) 117.7 (6.)
 Trefferlage 0.17 mm rechts, 0.64 mm tief
 Streuwert 1.31, horizontal: 1.34, vertikal: 1.28

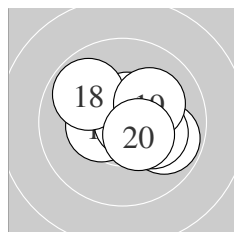

Serie 2:
 10.8 * 9.8 ↘ 10.7 * 10.2 * 10.4 *
 10.6 * 10.8 * 9.9 ↘ 10.1 ↗ 10.4 *
 beste Teiler 38.2 (11.) 45.0 (17.) 67.8 (13.)
 Trefferlage 0.46 mm rechts, 0.15 mm hoch
 Streuwert 1.21, horizontal: 1.44, vertikal: 0.91

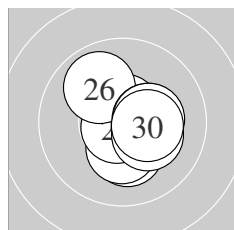

Serie 3:
 10.2 * 10.7 * 10.3 * 10.8 * 10.3 *
 9.9 ↘ 10.3 * 10.3 * 10.3 * 10.3 *
 beste Teiler 48.8 (24.) 75.9 (22.) 156.5 (30.)
 Trefferlage 0.64 mm rechts, 0.17 mm tief
 Streuwert 1.11, horizontal: 1.08, vertikal: 1.14

 Unterschrift des Schützen

Meyton Elektronik

Ergebnis: **311.8** (298)
 Serien: 105.1 104.2 102.5
 Zähler: 28 2 0 0 0 0 0 0 0 0
 Innenzehner: 24
 weiteste: 255 (8), 252 (27), 222 (26)
 beste Teiler 8.5 (5.) 14.4 (4.) 65.3 (7.)
 Trefferlage 0.24 mm rechts, 0.45 mm hoch
 Streuwert 1.05, horizontal: 1.14, vertikal: 0.94

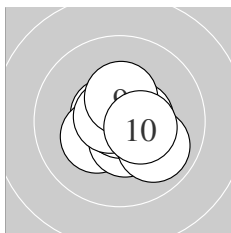
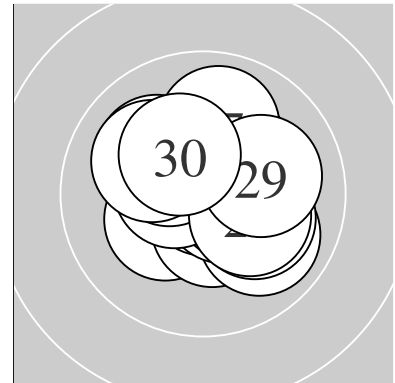

Serie 1:
 10.6 * 10.3 * 10.5 * 10.9 * 10.9 *
 10.5 * 10.7 * 9.9 ↘ 10.4 * 10.4 *
 beste Teiler 8.5 (5.) 14.4 (4.) 65.3 (7.)
 Trefferlage 0.20 mm rechts, 0.16 mm tief
 Streuwert 0.95, horizontal: 1.04, vertikal: 0.86

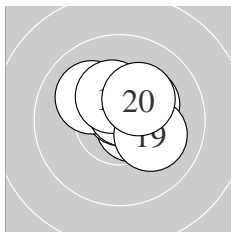

Serie 2:
 10.6 * 10.7 * 10.3 * 10.1 ↘ 10.6 *
 10.5 * 10.7 * 10.3 * 10.1 ↘ 10.3 *
 beste Teiler 67.3 (12.) 70.0 (17.) 83.9 (11.)
 Trefferlage 0.50 mm rechts, 0.63 mm hoch
 Streuwert 0.90, horizontal: 1.03, vertikal: 0.74

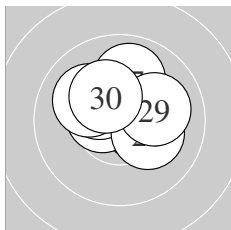

Serie 3:
 10.5 * 10.3 * 10.3 * 10.5 * 10.3 *
 10.1 ↘ 9.9 ↑ 10.2 * 10.1 → 10.3 *
 beste Teiler 107.9 (24.) 124.5 (21.) 152.7 (22.)
 Trefferlage 0.03 mm rechts, 0.87 mm hoch
 Streuwert 1.19, horizontal: 1.39, vertikal: 0.94

Unterschrift des Schützen

Ergebnis: **305.0** (291)
 Serien: 100.2 101.1 103.7
 Zähler: 21 9 0 0 0 0 0 0 0 0
 Innenzehner: 15
 weiteste: 422 (4), 360 (10), 342 (1)
 beste Teiler 41.0 (5.) 48.2 (29.) 62.0 (25.)
 Trefferlage 0.52 mm links, 0.01 mm tief
 Streuwert 1.55, horizontal: 1.34, vertikal: 1.73

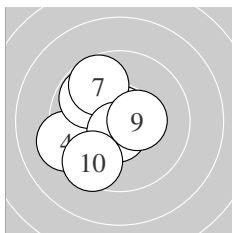
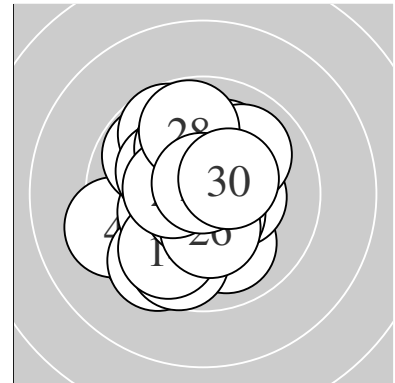

Serie 1:
 9.6 ↙ 10.7 * 9.8 ↘ 9.3 ← 10.8 *
 9.8 ↘ 9.7 ↘ 10.6 * 10.4 * 9.5 ↙
 beste Teiler 41.0 (5.) 63.2 (2.) 83.1 (8.)
 Trefferlage 1.36 mm links, 0.50 mm tief
 Streuwert 1.68, horizontal: 1.49, vertikal: 1.85

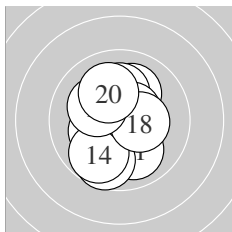

Serie 2:
 10.0 ↘ 10.2 * 9.7 ↓ 9.8 ↙ 10.1 ↗
 10.1 ↑ 10.5 * 10.4 * 10.2 * 10.1 ↘
 beste Teiler 104.8 (17.) 149.6 (18.) 177.0 (12.)
 Trefferlage 0.24 mm links, 0.08 mm tief
 Streuwert 1.62, horizontal: 1.24, vertikal: 1.93

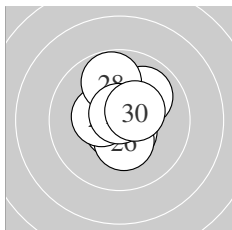

Serie 3:
 10.5 * 10.7 * 10.1 ↑ 10.0 ↗ 10.7 *
 10.3 * 10.4 * 9.8 ↑ 10.8 * 10.4 *
 beste Teiler 48.2 (29.) 62.0 (25.) 67.2 (22.)
 Trefferlage 0.03 mm rechts, 0.53 mm hoch
 Streuwert 1.17, horizontal: 0.91, vertikal: 1.39

Unterschrift des Schützen

Ergebnis: **307.6** (297)
 Serien: 101.4 102.7 103.5
 Zähler: 27 3 0 0 0 0 0 0 0 0
 Innenzehner: 17
 weiteste: 284 (15), 264 (26), 252 (7)
 beste Teiler 10.7 (16.) 48.0 (22.) 75.1 (21.)
 Trefferlage 0.09 mm links, 0.27 mm hoch
 Streuwert 1.35, horizontal: 1.60, vertikal: 1.04

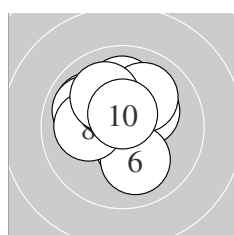
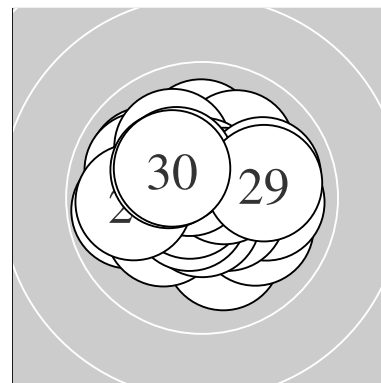

Serie 1:
 10.0 ↑ 10.0 ↘ 10.5 * 10.2 * 10.0 ↗
 10.1 ↓ 9.9 ↙ 10.1 ← 10.0 ↖ 10.6 *
 beste Teiler 85.0 (10.) 124.4 (3.) 176.2 (4.)
 Trefferlage 0.37 mm links, 0.72 mm hoch
 Streuwert 1.43, horizontal: 1.46, vertikal: 1.41

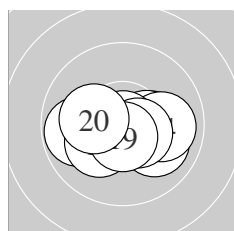

Serie 2:
 10.2 * 10.0 ↘ 10.3 * 10.0 → 9.8 ←
 10.9 * 10.5 * 10.2 * 10.6 * 10.2 *
 beste Teiler 10.7 (16.) 81.0 (19.) 112.5 (17.)
 Trefferlage 0.28 mm rechts, 0.43 mm tief
 Streuwert 1.33, horizontal: 1.82, vertikal: 0.50

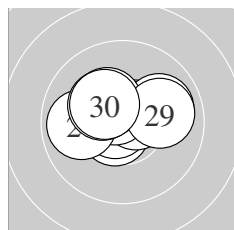

Serie 3:
 10.7 * 10.8 * 10.6 * 10.6 * 10.0 →
 9.9 ← 10.3 * 10.3 * 10.0 → 10.3 *
 beste Teiler 48.0 (22.) 75.1 (21.) 91.5 (24.)
 Trefferlage 0.19 mm links, 0.53 mm hoch
 Streuwert 1.22, horizontal: 1.61, vertikal: 0.62

Unterschrift des Schützen

Ergebnis: **295.7** (283)
 Serien: 96.9 99.5 99.3
 Zähler: 14 15 1 0 0 0 0 0 0 0
 Innenzehner: 9
 weiteste: 523 (19), 477 (4), 474 (23)
 beste Teiler 103.3 (27.) 146.0 (1.) 152.3 (13.)
 Trefferlage 0.94 mm links, 0.03 mm hoch
 Streuwert 2.02, horizontal: 2.18, vertikal: 1.83

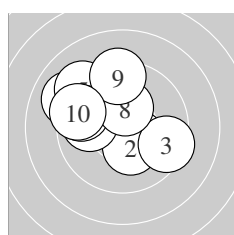
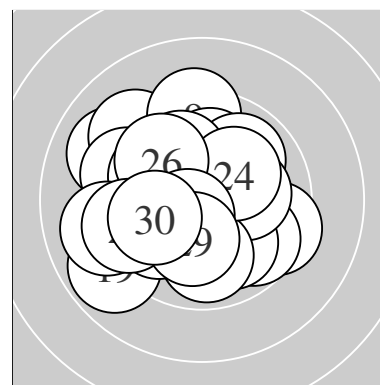

Serie 1:
 10.4 * 10.3 * 9.5 ↘ 9.0 ↖ 9.2 ↖
 9.9 ← 9.6 ← 10.3 * 9.3 ↑ 9.4 ↖
 beste Teiler 146.0 (1.) 156.4 (8.) 169.5 (2.)
 Trefferlage 1.18 mm links, 0.96 mm hoch
 Streuwert 2.24, horizontal: 2.55, vertikal: 1.87

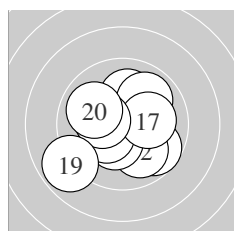

Serie 2:
 9.7 ↘ 10.0 ↘ 10.3 * 10.1 ↑ 9.9 ↗
 10.3 * 10.1 → 10.3 * 8.9 ↙ 9.9 ↖
 beste Teiler 152.3 (13.) 152.5 (16.) 163.9 (18.)
 Trefferlage 0.18 mm links, 0.35 mm tief
 Streuwert 1.98, horizontal: 2.16, vertikal: 1.78

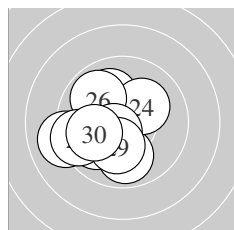

Serie 3:
 10.1 ↖ 9.9 ↓ 9.1 ← 10.2 * 9.9 ↙
 9.9 ↖ 10.5 * 9.5 ← 10.2 * 10.0 ←
 beste Teiler 103.3 (27.) 192.5 (29.) 196.7 (24.)
 Trefferlage 1.47 mm links, 0.51 mm tief
 Streuwert 1.71, horizontal: 1.78, vertikal: 1.64

Unterschrift des Schützen

Meyton Elektronik

Ergebnis: **299.7** (289)
 Serien: 99.7 101.4 98.6
 Zähler: 21 7 2 0 0 0 0 0 0 0
 Innenzehner: 11
 weiteste: 685 (26), 671 (30), 442 (15)
 beste Teiler 35.9 (25.) 77.1 (20.) 80.5 (11.)
 Trefferlage 0.41 mm links, 0.77 mm hoch
 Streuwert 1.96, horizontal: 2.33, vertikal: 1.49

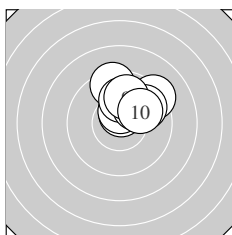
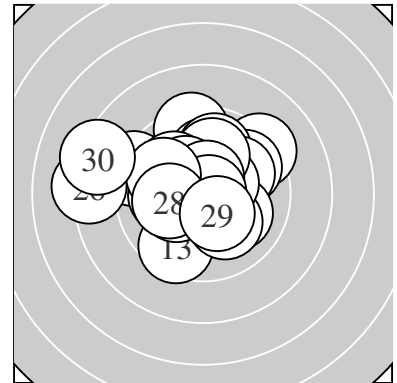

Serie 1:
 9.4 ↑ 10.1 ↑ 10.6 * 10.5 * 9.3 ↗
 10.0 ↑ 10.1 ↗ 9.8 ↗ 9.9 ↑ 10.0 ↗
 beste Teiler 89.4 (3.) 121.2 (4.) 215.6 (2.)
 Trefferlage 1.03 mm rechts, 1.98 mm hoch
 Streuwert 1.10, horizontal: 1.28, vertikal: 0.88

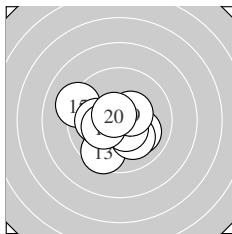

Serie 2:
 10.6 * 10.1 ↘ 9.5 ↓ 10.1 ↘ 9.2 ↖
 10.1 ← 10.5 * 10.3 * 10.4 * 10.6 *
 beste Teiler 77.1 (20.) 80.5 (11.) 108.2 (17.)
 Trefferlage 0.44 mm links, 0.49 mm tief
 Streuwert 1.66, horizontal: 1.94, vertikal: 1.32

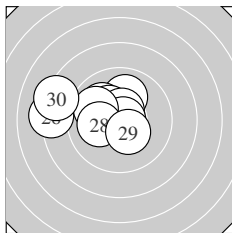

Serie 3:
 10.0 ↑ 10.0 ↘ 10.3 * 10.6 * 10.8 *
 8.2 ← 9.9 ↖ 10.1 ← 10.4 * 8.3 ↖
 beste Teiler 35.9 (25.) 97.5 (24.) 145.4 (29.)
 Trefferlage 1.84 mm links, 0.82 mm hoch
 Streuwert 2.10, horizontal: 2.75, vertikal: 1.11

Unterschrift des Schützen

Ergebnis: **294.2** (283)
 Serien: 99.0 97.5 97.7
 Zähler: 15 13 2 0 0 0 0 0 0 0
 Innenzehner: 6
 weiteste: 574 (21), 570 (10), 472 (22)
 beste Teiler 71.3 (5.) 166.5 (13.) 171.7 (12.)
 Trefferlage 1.32 mm links, 1.95 mm hoch
 Streuwert 1.47, horizontal: 1.81, vertikal: 1.01

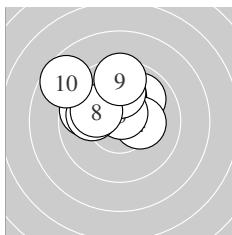
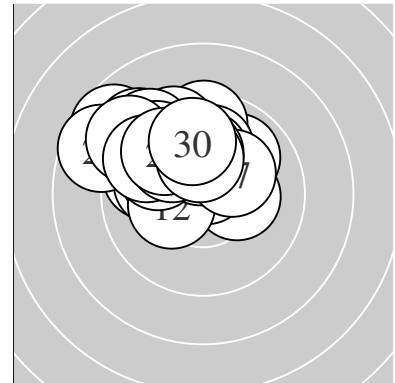

Serie 1:
 9.9 ↗ 10.1 ↑ 9.7 ↖ 10.3 * 10.7 *
 10.0 ↑ 10.0 ← 10.1 ↖ 9.5 ↑ 8.7 ↖
 beste Teiler 71.3 (5.) 175.5 (4.) 210.1 (2.)
 Trefferlage 0.80 mm links, 1.63 mm hoch
 Streuwert 1.71, horizontal: 2.07, vertikal: 1.25

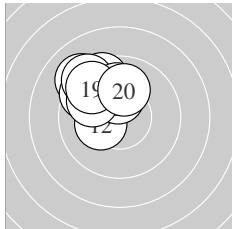

Serie 2:
 9.5 ↖ 10.3 * 10.3 * 9.1 ↖ 9.5 ↖
 9.3 ↖ 10.0 ↑ 9.9 ↖ 9.6 ↖ 10.0 ↑
 beste Teiler 166.5 (13.) 171.7 (12.) 237.0 (20.)
 Trefferlage 1.68 mm links, 2.14 mm hoch
 Streuwert 1.22, horizontal: 1.29, vertikal: 1.15

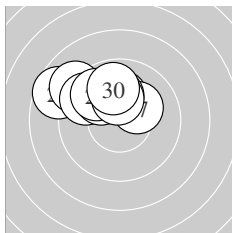

Serie 3:
 8.7 ↖ 9.1 ↖ 9.6 ↖ 10.0 ↖ 10.1 ↑
 9.8 ↖ 10.2 * 10.1 ↑ 10.2 * 9.9 ↑
 beste Teiler 182.7 (29.) 184.2 (27.) 203.4 (25.)
 Trefferlage 1.47 mm links, 2.07 mm hoch
 Streuwert 1.49, horizontal: 2.04, vertikal: 0.50

Unterschrift des Schützen

Ergebnis: **306.6** (295)
 Serien: 101.1 103.1 102.4
 Zähler: 25 5 0 0 0 0 0 0 0 0
 Innenzehner: 17
 weiteste: 428 (23), 420 (2), 324 (11)
 beste Teiler 49.9 (30.) 52.2 (10.) 55.7 (22.)
 Trefferlage 0.45 mm links, 0.16 mm tief
 Streuwert 1.45, horizontal: 1.26, vertikal: 1.62

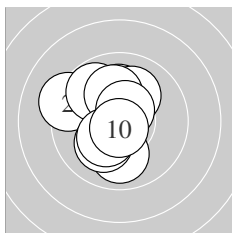
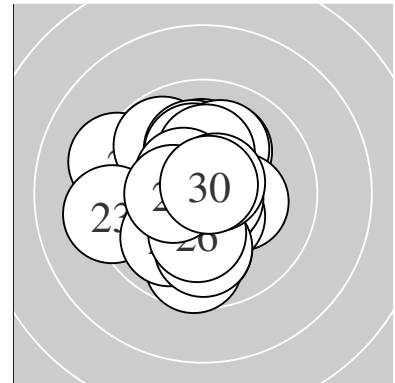

Serie 1:
 10.1 ↑ 9.3 ↖ 9.8 ↘ 10.0 ↓ 10.1 ↙
 10.1 ↗ 10.1 ↑ 10.3 * 10.6 * 10.7 *
 beste Teiler 52.2 (10.) 95.7 (9.) 161.8 (8.)
 Trefferlage 0.73 mm links, 0.47 mm hoch
 Streuwert 1.61, horizontal: 1.39, vertikal: 1.79

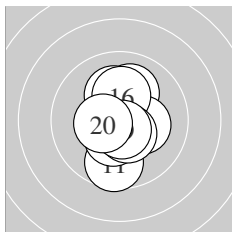

Serie 2:
 9.7 ↓ 10.1 ↗ 10.2 * 10.6 * 10.3 *
 10.2 * 10.4 * 10.5 * 10.7 * 10.4 *
 beste Teiler 74.2 (19.) 88.4 (14.) 119.2 (18.)
 Trefferlage 0.06 mm rechts, 0.19 mm tief
 Streuwert 1.33, horizontal: 0.82, vertikal: 1.68

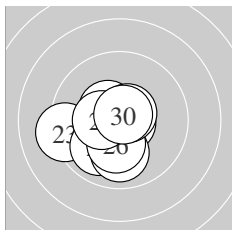

Serie 3:
 10.1 ↓ 10.7 * 9.2 ↖ 9.9 ↗ 10.0 ↓
 10.2 * 10.5 * 10.6 * 10.4 * 10.8 *
 beste Teiler 49.9 (30.) 55.7 (22.) 80.0 (28.)
 Trefferlage 0.70 mm links, 0.76 mm tief
 Streuwert 1.33, horizontal: 1.43, vertikal: 1.23

Unterschrift des Schützen

Ergebnis: **304.0** (294)
 Serien: 102.3 100.1 101.6
 Zähler: 24 6 0 0 0 0 0 0 0 0
 Innenzehner: 14
 weiteste: 454 (20), 348 (19), 326 (21)
 beste Teiler 40.3 (16.) 57.1 (25.) 74.8 (6.)
 Trefferlage 0.36 mm links, 0.36 mm tief
 Streuwert 1.55, horizontal: 1.71, vertikal: 1.38

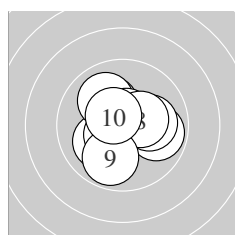
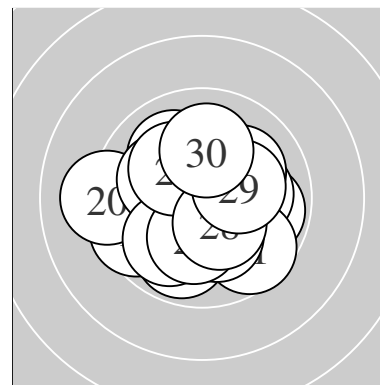

Serie 1:
 10.2 * 10.1 ↙ 10.0 ↘ 10.5 * 9.9 →
 10.7 * 10.1 → 10.4 * 9.9 ↓ 10.5 *
 beste Teiler 74.8 (6.) 104.6 (10.) 114.1 (4.)
 Trefferlage 0.01 mm links, 0.05 mm hoch
 Streuwert 1.47, horizontal: 1.56, vertikal: 1.37

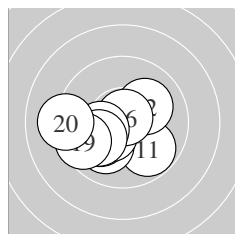

Serie 2:
 9.8 ↘ 10.1 ↗ 10.0 ✓ 10.1 ✓ 10.4 *
 10.8 * 10.2 * 10.0 ✓ 9.6 ✓ 9.1 ←
 beste Teiler 40.3 (16.) 137.3 (15.) 182.7 (17.)
 Trefferlage 1.15 mm links, 0.78 mm tief
 Streuwert 1.61, horizontal: 2.02, vertikal: 1.05

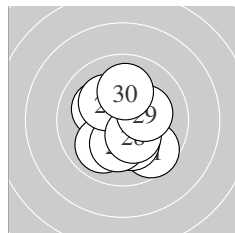

Serie 3:
 9.6 ↘ 10.1 ↖ 10.2 * 10.0 ✓ 10.7 *
 10.2 * 10.2 * 10.4 * 10.2 * 10.0 ↑
 beste Teiler 57.1 (25.) 145.6 (28.) 183.4 (29.)
 Trefferlage 0.07 mm rechts, 0.34 mm tief
 Streuwert 1.52, horizontal: 1.37, vertikal: 1.66

Unterschrift des Schützen

Meyton Elektronik

Ergebnis: **306.4** (294)
 Serien: 102.3 101.2 102.9
 Zähler: 24 6 0 0 0 0 0 0 0 0
 Innenzehner: 17
 weiteste: 418 (24), 318 (18), 307 (1)
 beste Teiler 31.7 (23.) 59.4 (21.) 62.6 (25.)
 Trefferlage 0.45 mm rechts, 0.04 mm hoch
 Streuwert 1.42, horizontal: 1.50, vertikal: 1.33

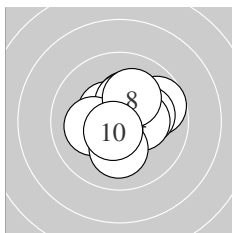
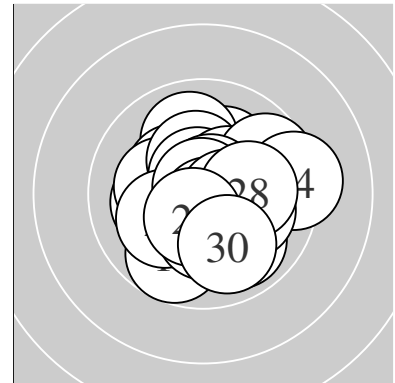

Serie 1:
 9.7 → 10.1 → 10.5 * 10.3 * 10.3 *
 10.4 * 10.1 ← 10.2 * 10.1 ↓ 10.6 *
 beste Teiler 89.3 (10.) 120.7 (3.) 147.4 (6.)
 Trefferlage 0.46 mm rechts, 0.39 mm hoch
 Streuwert 1.33, horizontal: 1.44, vertikal: 1.21

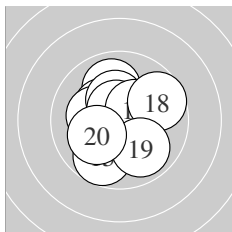

Serie 2:
 10.0 ↑ 10.3 * 10.2 * 10.3 * 9.7 ↓
 10.6 * 10.4 * 9.7 → 9.9 ↘ 10.1 ←
 beste Teiler 84.1 (16.) 143.0 (17.) 158.6 (12.)
 Trefferlage 0.17 mm links, 0.24 mm hoch
 Streuwert 1.62, horizontal: 1.56, vertikal: 1.67

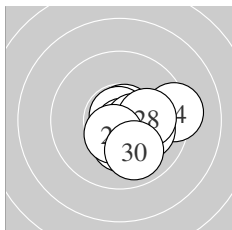

Serie 3:
 10.7 * 10.3 * 10.8 * 9.3 → 10.7 *
 10.5 * 10.1 ↘ 10.1 → 10.5 * 9.9 ↘
 beste Teiler 31.7 (23.) 59.4 (21.) 62.6 (25.)
 Trefferlage 1.06 mm rechts, 0.50 mm tief
 Streuwert 1.19, horizontal: 1.37, vertikal: 0.96

Unterschrift des Schützen

Ergebnis: **303.0** (287)
 Serien: 102.4 99.3 101.3
 Zähler: 18 11 1 0 0 0 0 0 0 0
 Innenzehner: 16
 weiteste: 540 (15), 444 (21), 361 (1)
 beste Teiler 30.6 (3.) 43.9 (4.) 58.6 (29.)
 Trefferlage 0.24 mm rechts, 0.17 mm hoch
 Streuwert 1.74, horizontal: 1.87, vertikal: 1.59

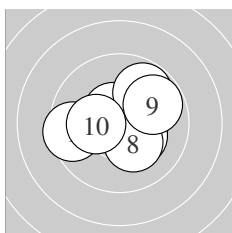
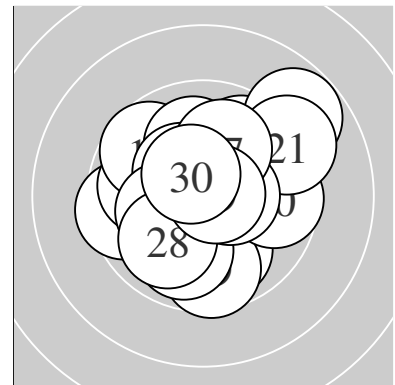

Serie 1:
 9.5 ← 10.4 * 10.8 * 10.8 * 10.6 *
 10.3 * 9.8 ↗ 10.2 * 9.8 ↗ 10.2 *
 beste Teiler 30.6 (3.) 43.9 (4.) 97.4 (5.)
 Trefferlage 0.22 mm rechts, 0.17 mm hoch
 Streuwert 1.51, horizontal: 1.83, vertikal: 1.11

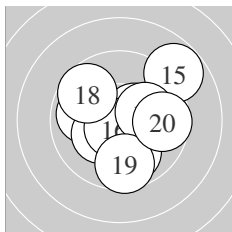

Serie 2:
 9.9 ← 9.9 ↓ 10.5 * 10.3 * 8.8 ↗
 10.7 * 10.2 * 9.7 ↘ 9.6 ↓ 9.7 →
 beste Teiler 74.4 (16.) 123.8 (13.) 175.2 (14.)
 Trefferlage 0.47 mm rechts, 0.02 mm tief
 Streuwert 2.12, horizontal: 2.24, vertikal: 1.99

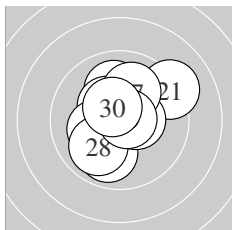

Serie 3:
 9.2 ↗ 10.0 ↑ 9.9 ↓ 10.4 * 10.5 *
 10.2 * 10.0 ↑ 9.9 ↙ 10.7 * 10.5 *
 beste Teiler 58.6 (29.) 113.2 (30.) 124.0 (25.)
 Trefferlage 0.03 mm rechts, 0.37 mm hoch
 Streuwert 1.68, horizontal: 1.66, vertikal: 1.70

Unterschrift des Schützen

Ergebnis: **294.5** (281)
 Serien: 98.6 99.7 96.2
 Zähler: 13 15 2 0 0 0 0 0 0 0
 Innenzehner: 9
 weiteste: 668 (25), 537 (20), 498 (16)
 beste Teiler 52.4 (17.) 61.0 (19.) 81.7 (28.)
 Trefferlage 0.23 mm links, 0.13 mm hoch
 Streuwert 2.31, horizontal: 2.80, vertikal: 1.69

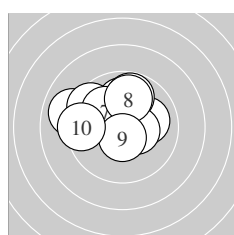
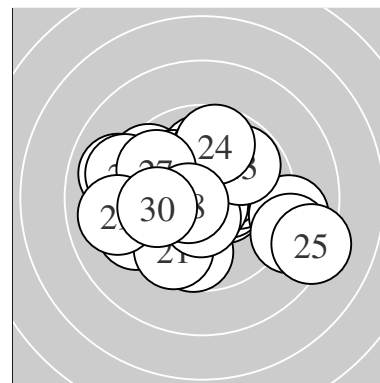

Serie 1:
 10.0 ↑ 10.0 → 9.8 ↑ 9.0 ↖ 10.4 *
 9.5 ↘ 10.0 ↘ 9.9 ↑ 10.6 * 9.4 ←
 beste Teiler 98.0 (9.) 129.7 (5.) 226.2 (7.)
 Trefferlage 0.86 mm links, 1.21 mm hoch
 Streuwert 1.89, horizontal: 2.33, vertikal: 1.32

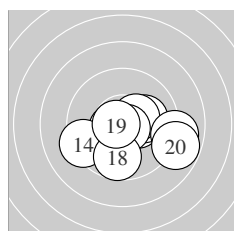

Serie 2:
 10.6 * 10.4 * 10.1 → 9.3 ↖ 10.4 *
 9.0 → 10.7 * 9.7 ↓ 10.7 * 8.8 →
 beste Teiler 52.4 (17.) 61.0 (19.) 100.8 (11.)
 Trefferlage 0.91 mm rechts, 0.75 mm tief
 Streuwert 2.05, horizontal: 2.65, vertikal: 1.19

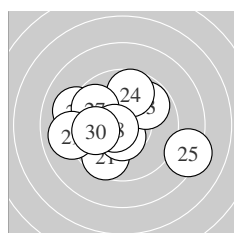

Serie 3:
 9.6 ↙ 10.5 * 9.8 ↗ 9.7 ↑ 8.3 →
 9.1 ↖ 9.7 ↖ 10.6 * 9.0 ← 9.9 ←
 beste Teiler 81.7 (28.) 110.1 (22.) 258.2 (30.)
 Trefferlage 0.75 mm links, 0.05 mm tief
 Streuwert 2.68, horizontal: 3.25, vertikal: 1.96

Unterschrift des Schützen

Ergebnis: **308.6** (294)
 Serien: 102.5 103.7 102.4
 Zähler: 24 6 0 0 0 0 0 0 0 0
 Innenzehner: 21
 weiteste: 346 (4), 306 (5), 289 (21)
 beste Teiler 27.8 (10.) 68.8 (13.) 70.5 (19.)
 Trefferlage 0.48 mm rechts, 0.11 mm hoch
 Streuwert 1.28, horizontal: 1.36, vertikal: 1.19

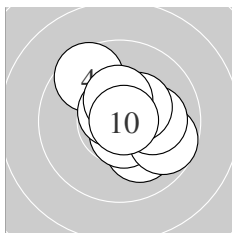
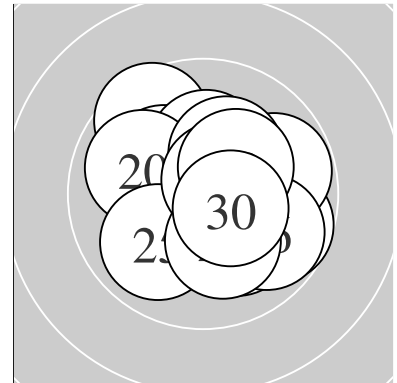

Serie 1:
 10.1 ↗ 10.1 ↘ 10.6 * 9.6 ↖ 9.7 ↘
 10.7 * 10.1 → 10.4 * 10.4 * 10.8 *
 beste Teiler 27.8 (10.) 75.4 (6.) 83.8 (3.)
 Trefferlage 0.75 mm rechts, 0.15 mm hoch
 Streuwert 1.39, horizontal: 1.45, vertikal: 1.34

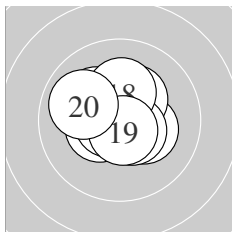

Serie 2:
 10.3 * 10.4 * 10.7 * 10.2 * 10.5 *
 10.3 * 10.5 * 10.2 * 10.7 * 9.9 ↖
 beste Teiler 68.8 (13.) 70.5 (19.) 104.3 (17.)
 Trefferlage 0.27 mm links, 0.39 mm hoch
 Streuwert 1.11, horizontal: 1.21, vertikal: 0.98

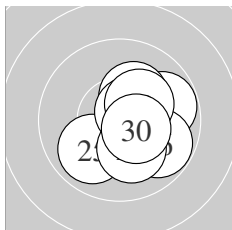

Serie 3:
 9.8 → 10.6 * 10.2 * 10.5 * 9.9 ↙
 9.8 ↘ 10.6 * 10.2 * 10.3 * 10.5 *
 beste Teiler 83.6 (27.) 90.3 (22.) 110.8 (24.)
 Trefferlage 0.96 mm rechts, 0.21 mm tief
 Streuwert 1.24, horizontal: 1.21, vertikal: 1.26

 Unterschrift des Schützen

Ergebnis: **310.7** (298)
 Serien: 104.0 103.0 103.7
 Zähler: 28 2 0 0 0 0 0 0 0 0
 Innenzehner: 25
 weiteste: 330 (24), 291 (19), 235 (8)
 beste Teiler 26.1 (20.) 26.9 (4.) 42.5 (22.)
 Trefferlage 0.12 mm links, 0.26 mm hoch
 Streuwert 1.16, horizontal: 1.29, vertikal: 1.02

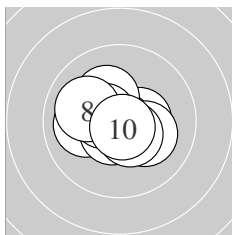
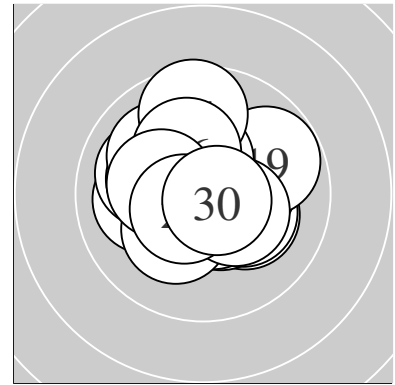

Serie 1:
 10.0 ← 10.4 * 10.6 * 10.8 * 10.2 *
 10.5 * 10.2 * 10.0 ↖ 10.5 * 10.8 *
 beste Teiler 26.9 (4.) 45.1 (10.) 90.1 (3.)
 Trefferlage 0.29 mm links, 0.05 mm tief
 Streuwert 1.12, horizontal: 1.37, vertikal: 0.79

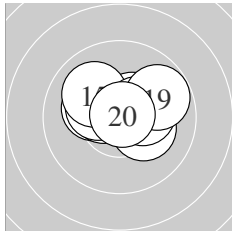

Serie 2:
 10.2 * 10.5 * 10.3 * 10.5 * 10.0 ↗
 10.2 * 10.4 * 10.3 * 9.8 ↘ 10.8 *
 beste Teiler 26.1 (20.) 117.9 (12.) 118.8 (14.)
 Trefferlage 0.20 mm rechts, 0.57 mm hoch
 Streuwert 1.22, horizontal: 1.60, vertikal: 0.64

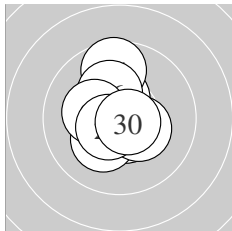

Serie 3:
 10.4 * 10.8 * 10.6 * 9.6 ↑ 10.2 *
 10.2 * 10.4 * 10.2 * 10.6 * 10.7 *
 beste Teiler 42.5 (22.) 63.0 (30.) 94.8 (23.)
 Trefferlage 0.29 mm links, 0.26 mm hoch
 Streuwert 1.20, horizontal: 0.88, vertikal: 1.45

Unterschrift des Schützen

Ergebnis: **311.8** (298)
 Serien: 105.0 103.6 103.2
 Zähler: 28 2 0 0 0 0 0 0 0 0
 Innenzehner: 24
 weiteste: 310 (28), 304 (17), 234 (23)
 beste Teiler 23.5 (22.) 26.5 (10.) 26.9 (19.)
 Trefferlage 0.24 mm links, 0.30 mm tief
 Streuwert 1.10, horizontal: 1.31, vertikal: 0.84

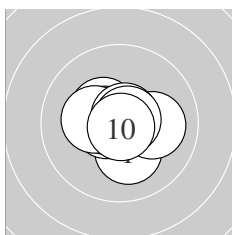
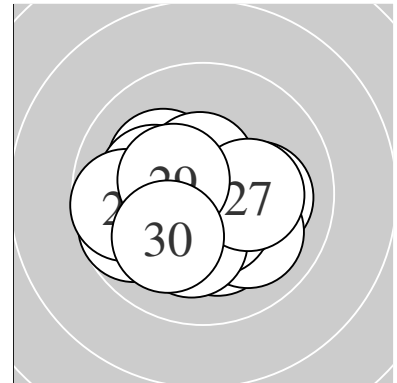

Serie 1:
 10.2 * 10.6 * 10.4 * 10.6 * 10.6 *
 10.3 * 10.1 → 10.7 * 10.7 * 10.8 *
 beste Teiler 26.5 (10.) 55.0 (8.) 56.8 (9.)
 Trefferlage 0.17 mm links, 0.02 mm tief
 Streuwert 0.94, horizontal: 1.13, vertikal: 0.71

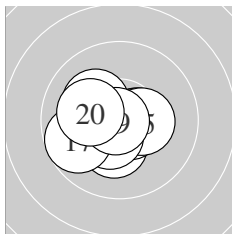

Serie 2:
 10.5 * 10.3 * 10.5 * 10.6 * 10.4 *
 10.5 * 9.7 ← 10.2 * 10.8 * 10.1 ←
 beste Teiler 26.9 (19.) 77.1 (14.) 103.6 (11.)
 Trefferlage 0.32 mm links, 0.30 mm tief
 Streuwert 1.17, horizontal: 1.44, vertikal: 0.83

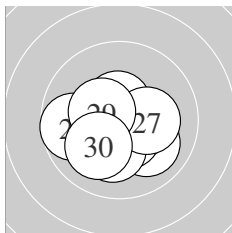

Serie 3:
 10.7 * 10.9 * 10.0 ↘ 10.5 * 10.5 *
 10.2 * 10.2 * 9.7 ← 10.4 * 10.1 ↙
 beste Teiler 23.5 (22.) 56.0 (21.) 103.8 (25.)
 Trefferlage 0.24 mm links, 0.57 mm tief
 Streuwert 1.24, horizontal: 1.46, vertikal: 0.97

Unterschrift des Schützen

Ergebnis: **302.6** (287)
 Serien: 100.2 99.4 103.0
 Zähler: 17 13 0 0 0 0 0 0 0 0
 Innenzehner: 13
 weiteste: 471 (2), 411 (12), 402 (17)
 beste Teiler 23.5 (30.) 37.6 (7.) 51.1 (1.)
 Trefferlage 0.54 mm rechts, 0.53 mm hoch
 Streuwert 1.68, horizontal: 1.90, vertikal: 1.43

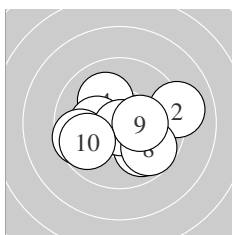
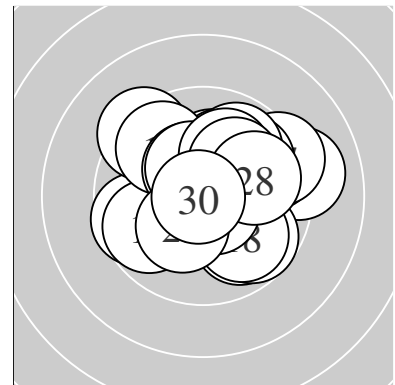

Serie 1:
 10.7 * 9.1 → 9.9 ↘ 10.1 ↖ 10.2 *
 9.6 ← 10.8 * 9.7 ↘ 10.3 * 9.8 ←
 beste Teiler 37.6 (7.) 51.1 (1.) 164.0 (9.)
 Trefferlage 0.22 mm rechts, 0.40 mm tief
 Streuwert 1.94, horizontal: 2.43, vertikal: 1.26

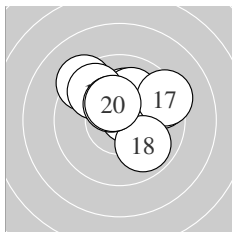

Serie 2:
 9.5 → 9.3 ↖ 10.2 * 10.6 * 10.1 ↗
 9.7 ↖ 9.3 → 9.9 ↘ 10.4 * 10.4 *
 beste Teiler 78.8 (14.) 144.4 (20.) 145.8 (19.)
 Trefferlage 0.47 mm rechts, 1.36 mm hoch
 Streuwert 1.74, horizontal: 2.08, vertikal: 1.33

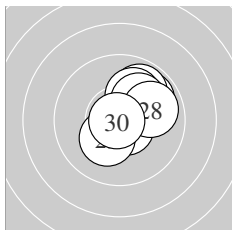

Serie 3:
 9.9 ↗ 10.6 * 9.9 ↗ 10.1 ↗ 10.7 *
 10.6 * 10.1 ↗ 9.9 → 10.3 * 10.9 *
 beste Teiler 23.5 (30.) 54.2 (25.) 77.1 (26.)
 Trefferlage 0.92 mm rechts, 0.65 mm hoch
 Streuwert 1.14, horizontal: 1.06, vertikal: 1.22

Unterschrift des Schützen

Ergebnis: **248.3** (234)
 Serien: 84.7 85.1 78.5 0.0
 Zähler: 0 4 16 10 0 0 0 0 0 0
 Innenzehner: 0
 weiteste: 1000 (28), 953 (25), 915 (26)
 beste Teiler 282.6 (16.) 407.7 (8.) 466.2 (18.)
 Trefferlage 0.56 mm links, 5.67 mm tief
 Streuwert 2.77, horizontal: 3.47, vertikal: 1.82

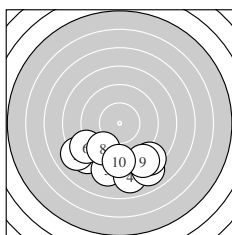
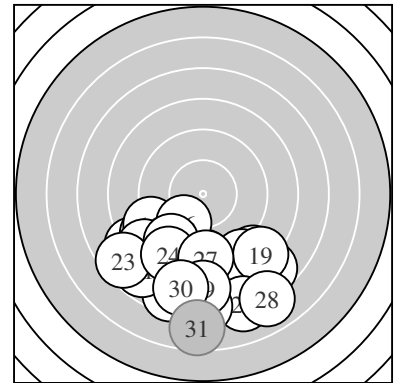

Serie 1:
 8.4 ↙ 8.1 ↙ 8.4 ↓ 8.0 ↓ 8.0 ↓
 8.7 ↙ 8.4 ↘ 9.3 ↙ 8.5 ↓ 8.9 ↓
 beste Teiler 407.7 (8.) 513.1 (10.) 554.6 (6.)
 Trefferlage 0.61 mm links, 5.01 mm tief
 Streuwert 2.74, horizontal: 3.66, vertikal: 1.28

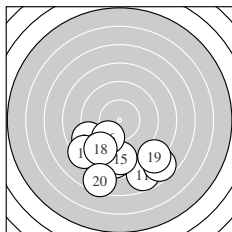

Serie 2:
 7.8 ↓ 9.0 ↙ 7.7 ↘ 8.7 ↓ 8.9 ↓
 9.8 ↙ 8.4 ↙ 9.1 ↙ 8.2 ↓ 7.5 ↓
 beste Teiler 282.6 (16.) 466.2 (18.) 492.0 (12.)
 Trefferlage 0.31 mm links, 5.02 mm tief
 Streuwert 2.89, horizontal: 3.63, vertikal: 1.88

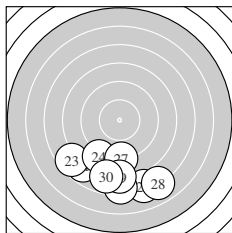

Serie 3:
 7.8 ↙ 8.4 ↓ 7.6 ↙ 8.7 ↙ 7.1 ↓
 7.3 ↓ 8.9 ↓ 7.0 ↘ 7.9 ↓ 7.8 ↓
 beste Teiler 522.4 (27.) 565.7 (24.) 628.7 (22.)
 Trefferlage 0.75 mm links, 6.99 mm tief
 Streuwert 2.72, horizontal: 3.50, vertikal: 1.60

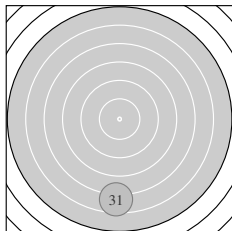

Serie 4:
 0.0+ ↓
 beste Teiler ^{AST.NSC}
 Trefferlage 0.00 mm , 0.00 mm
 Streuwert 0.00, horizontal: 0.00, vertikal: 0.00

AST – Treffer wurde nach Ende der Schießzeit abgegeben
 NSC – Treffer wurde vermessen, geht aber nicht in die Wertung ein

Unterschrift des Schützen

Meyton Elektronik

Ergebnis: **310.9** (299)
 Serien: 103.5 104.0 103.4
 Zähler: 29 1 0 0 0 0 0 0 0 0
 Innenzehner: 24
 weiteste: 260 (13), 250 (1), 242 (26)
 beste Teiler 46.6 (2.) 63.9 (29.) 66.0 (3.)
 Trefferlage 0.48 mm links, 0.30 mm tief
 Streuwert 1.08, horizontal: 1.04, vertikal: 1.11

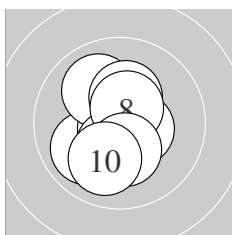
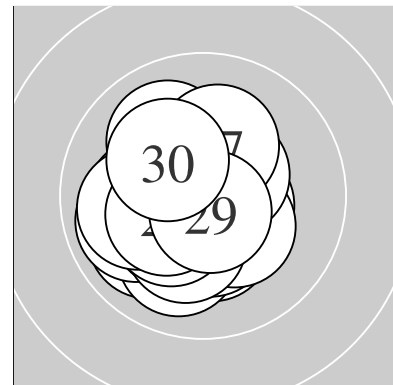

Serie 1:
 10.0 ↙ 10.8 * 10.7 * 10.0 ↘ 10.4 *
 10.3 * 10.5 * 10.5 * 10.3 * 10.0 ↘
 beste Teiler 46.6 (2.) 66.0 (3.) 104.6 (8.)
 Trefferlage 0.20 mm links, 0.29 mm tief
 Streuwert 1.22, horizontal: 0.97, vertikal: 1.43

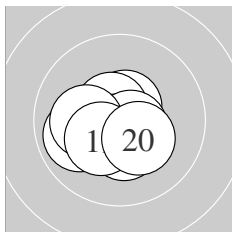

Serie 2:
 10.5 * 10.6 * 9.9 ↙ 10.6 * 10.7 *
 10.6 * 10.1 ← 10.4 * 10.3 * 10.3 *
 beste Teiler 72.9 (15.) 79.9 (16.) 85.0 (14.)
 Trefferlage 0.50 mm links, 0.48 mm tief
 Streuwert 0.98, horizontal: 1.17, vertikal: 0.76

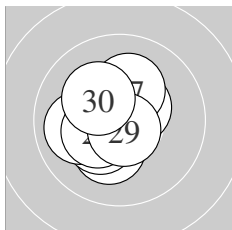

Serie 3:
 10.5 * 10.2 * 10.4 * 10.5 * 10.3 *
 10.0 ← 10.2 * 10.4 * 10.7 * 10.2 *
 beste Teiler 63.9 (29.) 121.3 (21.) 124.2 (24.)
 Trefferlage 0.74 mm links, 0.15 mm tief
 Streuwert 1.07, horizontal: 1.02, vertikal: 1.12

Unterschrift des Schützen

Ergebnis: **302.3** (292)
 Serien: 101.5 100.2 100.6
 Zähler: 22 8 0 0 0 0 0 0 0 0
 Innenzehner: 16
 weiteste: 447 (28), 389 (13), 363 (15)
 beste Teiler 97.7 (25.) 128.0 (23.) 128.7 (11.)
 Trefferlage 0.04 mm rechts, 0.13 mm tief
 Streuwert 1.68, horizontal: 2.06, vertikal: 1.19

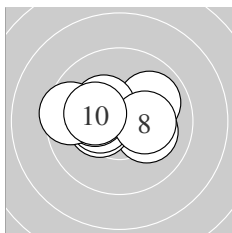
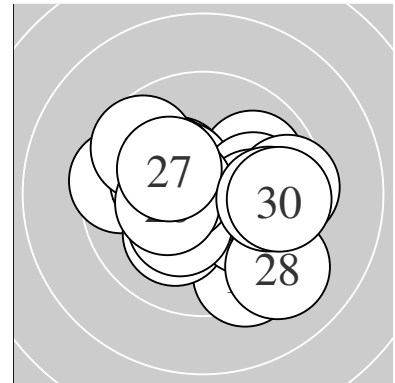

Serie 1:
 10.1 ↗ 10.3 * 10.4 * 9.9 ↗ 10.4 *
 10.2 * 10.3 * 10.2 * 9.5 ↖ 10.2 *
 beste Teiler 139.0 (5.) 146.0 (3.) 154.9 (7.)
 Trefferlage 0.65 mm links, 0.34 mm hoch
 Streuwert 1.43, horizontal: 1.92, vertikal: 0.64

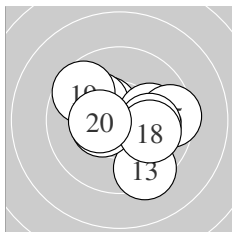

Serie 2:
 10.4 * 10.2 * 9.4 ↘ 10.1 → 9.5 →
 10.1 → 10.4 * 10.0 → 9.7 ↘ 10.4 *
 beste Teiler 128.7 (11.) 129.0 (17.) 141.2 (20.)
 Trefferlage 0.41 mm rechts, 0.03 mm tief
 Streuwert 1.85, horizontal: 2.16, vertikal: 1.46

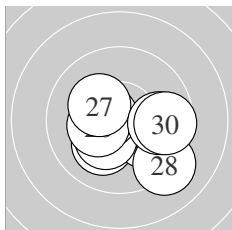

Serie 3:
 10.1 ↙ 10.1 ↘ 10.4 * 10.3 * 10.6 *
 10.3 * 10.2 * 9.2 ↘ 9.8 → 9.6 →
 beste Teiler 97.7 (25.) 128.0 (23.) 157.6 (26.)
 Trefferlage 0.37 mm rechts, 0.72 mm tief
 Streuwert 1.70, horizontal: 2.11, vertikal: 1.16

Unterschrift des Schützen

Ergebnis: **300.7** (287)
 Serien: 100.8 101.9 98.0
 Zähler: 17 13 0 0 0 0 0 0 0 0
 Innenzehner: 12
 weiteste: 437 (22), 426 (2), 410 (23)
 beste Teiler 52.6 (6.) 75.3 (27.) 85.2 (15.)
 Trefferlage 0.13 mm rechts, 0.17 mm hoch
 Streuwert 1.83, horizontal: 2.08, vertikal: 1.54

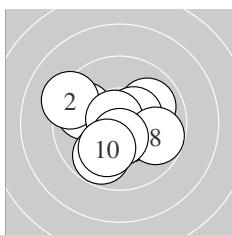
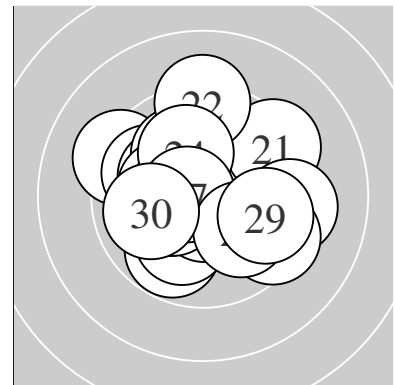

Serie 1:
 9.8 ↖ 9.2 ↖ 10.5 * 9.9 ↗ 10.5 *
 10.7 * 9.8 ↙ 9.8 → 10.5 * 10.1 ↘
 beste Teiler 52.6 (6.) 103.0 (3.) 110.0 (9.)
 Trefferlage 0.27 mm links, 0.24 mm tief
 Streuwert 1.79, horizontal: 2.08, vertikal: 1.44

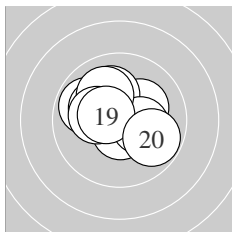

Serie 2:
 9.9 ↖ 10.2 * 10.2 * 10.1 ↗ 10.6 *
 10.3 * 10.1 ↖ 10.2 * 10.5 * 9.8 ↘
 beste Teiler 85.2 (15.) 113.6 (19.) 167.3 (16.)
 Trefferlage 0.31 mm links, 0.51 mm hoch
 Streuwert 1.44, horizontal: 1.70, vertikal: 1.12

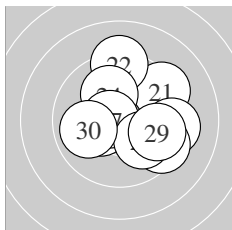

Serie 3:
 9.4 ↗ 9.2 ↑ 9.3 → 10.1 ↖ 9.4 ↘
 10.3 * 10.7 * 10.0 ↘ 9.7 → 9.9 ←
 beste Teiler 75.3 (27.) 156.7 (26.) 217.6 (24.)
 Trefferlage 0.98 mm rechts, 0.25 mm hoch
 Streuwert 2.18, horizontal: 2.34, vertikal: 2.00

Unterschrift des Schützen

Ergebnis: **300.1** (284)
 Serien: 98.4 100.9 100.8
 Zähler: 14 16 0 0 0 0 0 0 0 0
 Innenzehner: 13
 weiteste: 498 (13), 400 (24), 398 (6)
 beste Teiler 43.0 (15.) 63.7 (16.) 67.4 (23.)
 Trefferlage 0.57 mm links, 1.19 mm hoch
 Streuwert 1.67, horizontal: 2.05, vertikal: 1.19

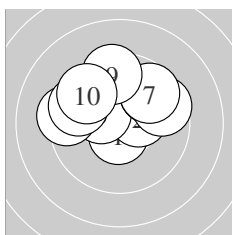
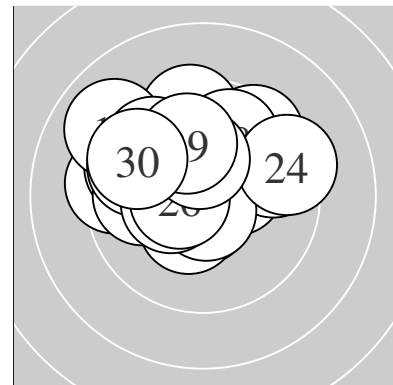

Serie 1:
 10.6 * 10.4 * 10.3 * 9.7 ↗ 9.6 →
 9.4 ← 9.7 ↗ 9.6 ↖ 9.5 ↑ 9.6 ↘
 beste Teiler 84.5 (1.) 148.6 (2.) 154.3 (3.)
 Trefferlage 0.24 mm links, 1.37 mm hoch
 Streuwert 1.95, horizontal: 2.46, vertikal: 1.25

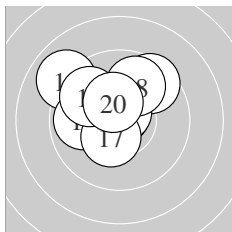

Serie 2:
 10.6 * 9.5 ↗ 9.0 ↘ 9.9 ← 10.8 *
 10.7 * 10.4 * 9.8 ↑ 9.8 ↘ 10.4 *
 beste Teiler 43.0 (15.) 63.7 (16.) 76.6 (11.)
 Trefferlage 0.70 mm links, 1.16 mm hoch
 Streuwert 1.62, horizontal: 1.85, vertikal: 1.35

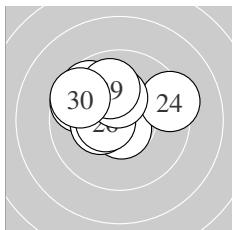

Serie 3:
 10.5 * 9.7 ↖ 10.7 * 9.4 → 10.4 *
 10.5 * 9.7 ↖ 10.3 * 10.0 ↑ 9.6 ↖
 beste Teiler 67.4 (23.) 102.6 (21.) 105.6 (26.)
 Trefferlage 0.78 mm links, 1.04 mm hoch
 Streuwert 1.57, horizontal: 1.95, vertikal: 1.06

Unterschrift des Schützen

Ergebnis: **39.1** (37)_{DNF}
 Serien: 39.1
 Zähler: 1 3 0 0 0 0 0 0 0 0
 Innenzehner: 1
 weiteste: 369 (3), 332 (4), 331 (2)
 beste Teiler 127.2 (1.) 331.3 (2.) 332.0 (4.)
 Trefferlage 1.39 mm rechts, 1.63 mm tief
 Streuwert 1.77, horizontal: 2.17, vertikal: 1.24

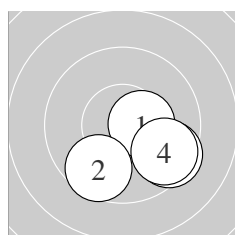
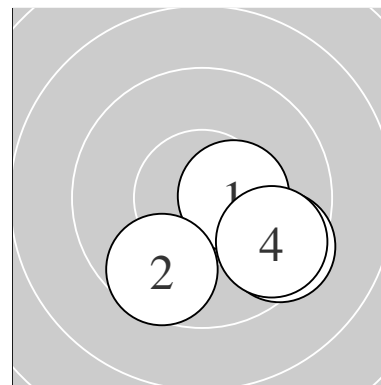

Serie 1:
 10.4 * 9.6 ↙ 9.5 ↘ 9.6 ↘ 0.0F
 0.0F_{MIS} 0.0F_{MIS} 0.0F_{MIS} 0.0F_{MIS} 0.0F_{MIS}
 beste Teiler 127.2 (1.) 331.3 (2.) 332.0 (4.)
 Trefferlage 1.39 mm rechts, 1.63 mm tief
 Streuwert 1.77, horizontal: 2.17, vertikal: 1.24

DNF – Schütze hat den Wettkampf nicht beendet
MIS – Treffer wurde manuell eingefügt, da der Schütze die Scheibe verfehlt hat

Unterschrift des Schützen

Ergebnis: **307.5** (294)
 Serien: 104.2 101.2 102.1
 Zähler: 24 6 0 0 0 0 0 0 0 0
 Innenzehner: 21
 weiteste: 465 (19), 408 (21), 293 (17)
 beste Teiler 11.3 (3.) 29.5 (6.) 37.5 (1.)
 Trefferlage 0.88 mm links, 0.60 mm tief
 Streuwert 1.23, horizontal: 1.39, vertikal: 1.05

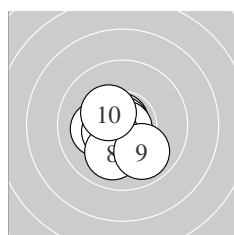
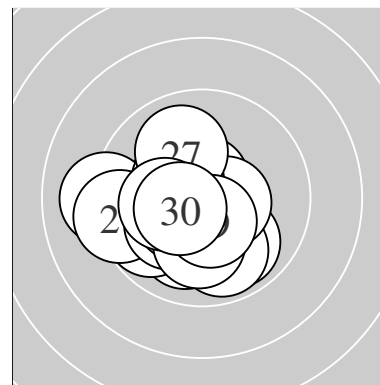

Serie 1:
 10.8 * 10.3 * 10.9 * 10.5 * 10.2 *
 10.8 * 10.5 * 10.0 ↓ 9.9 ↘ 10.3 *
 beste Teiler 11.3 (3.) 29.5 (6.) 37.5 (1.)
 Trefferlage 0.28 mm links, 0.65 mm tief
 Streuwert 1.02, horizontal: 0.99, vertikal: 1.06

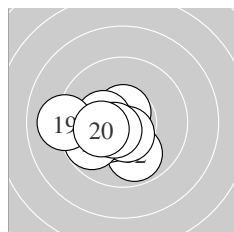

Serie 2:
 10.6 * 9.9 ↘ 10.4 * 10.3 * 9.8 ↙
 10.5 * 9.8 ↙ 10.6 * 9.1 ← 10.2 *
 beste Teiler 78.1 (11.) 94.7 (18.) 102.1 (16.)
 Trefferlage 1.33 mm links, 0.73 mm tief
 Streuwert 1.34, horizontal: 1.64, vertikal: 0.95

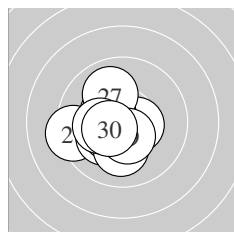

Serie 3:
 9.3 ← 10.5 * 10.2 * 10.4 * 10.4 *
 10.1 ↓ 10.0 ↘ 10.2 * 10.5 * 10.5 *
 beste Teiler 113.3 (22.) 118.0 (30.) 119.8 (29.)
 Trefferlage 1.02 mm links, 0.42 mm tief
 Streuwert 1.29, horizontal: 1.37, vertikal: 1.20

Unterschrift des Schützen

Meyton Elektronik

Ergebnis: **282.9** (270)
 Serien: 95.5 95.9 91.5
 Zähler: 7 17 5 1 0 0 0 0 0 0
 Innenzehner: 3
 weiteste: 876 (23), 724 (27), 679 (28)
 beste Teiler 105.3 (1.) 193.0 (9.) 195.2 (13.)
 Trefferlage 0.47 mm links, 0.71 mm tief
 Streuwert 2.93, horizontal: 3.53, vertikal: 2.18

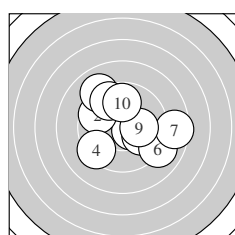
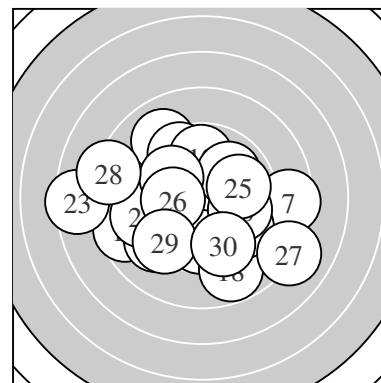

Serie 1:
 10.5 * 9.6 ↖ 10.0 ↗ 9.3 ↙ 9.0 ↘
 9.0 ↘ 8.5 → 9.6 ↘ 10.2 * 9.8 ↑
 beste Teiler 105.3 (1.) 193.0 (9.) 238.8 (3.)
 Trefferlage 0.48 mm rechts, 0.46 mm hoch
 Streuwert 2.76, horizontal: 3.14, vertikal: 2.30

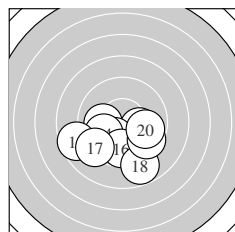

Serie 2:
 10.1 ↗ 10.0 ← 10.2 * 9.9 ↙ 8.6 ←
 9.7 ↓ 9.2 ↙ 8.8 ↓ 9.6 ↘ 9.8 →
 beste Teiler 195.2 (13.) 202.2 (11.) 228.2 (12.)
 Trefferlage 0.48 mm links, 1.97 mm tief
 Streuwert 2.23, horizontal: 2.81, vertikal: 1.44

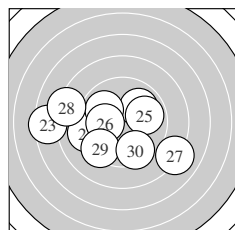

Serie 3:
 9.9 ↗ 9.2 ← 7.4 ← 9.9 ↖ 9.9 →
 10.1 ← 8.1 ↘ 8.2 ← 9.3 ↙ 9.5 ↓
 beste Teiler 205.2 (26.) 252.7 (21.) 257.6 (24.)
 Trefferlage 1.43 mm links, 0.61 mm tief
 Streuwert 3.53, horizontal: 4.50, vertikal: 2.15

Unterschrift des Schützen

Meyton Elektronik

Ergebnis: **300.6** (290)
 Serien: 99.0 100.9 100.7
 Zähler: 20 10 0 0 0 0 0 0 0 0
 Innenzehner: 10
 weiteste: 365 (5), 357 (7), 356 (9)
 beste Teiler 39.5 (1.) 107.4 (17.) 130.6 (6.)
 Trefferlage 0.30 mm links, 0.29 mm hoch
 Streuwert 1.75, horizontal: 1.71, vertikal: 1.80

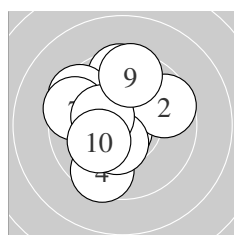
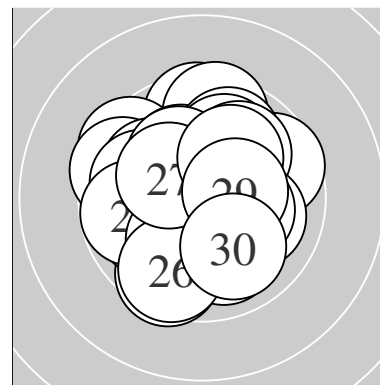

Serie 1:
 10.8 * 9.7 ↗ 9.6 ↑ 9.6 ↓ 9.5 ↘
 10.4 * 9.5 ↖ 10.3 * 9.5 ↑ 10.1 ←
 beste Teiler 39.5 (1.) 130.6 (6.) 154.5 (8.)
 Trefferlage 0.81 mm links, 0.62 mm hoch
 Streuwert 2.00, horizontal: 1.83, vertikal: 2.15

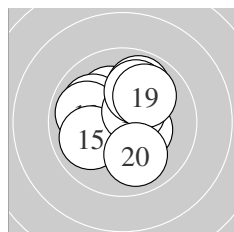

Serie 2:
 10.2 * 10.0 ↘ 9.9 ↖ 10.4 * 10.0 ←
 9.9 ↗ 10.5 * 10.0 ↑ 10.0 ↗ 10.0 ↓
 beste Teiler 107.4 (17.) 139.4 (14.) 192.7 (11.)
 Trefferlage 0.11 mm links, 0.68 mm hoch
 Streuwert 1.59, horizontal: 1.63, vertikal: 1.54

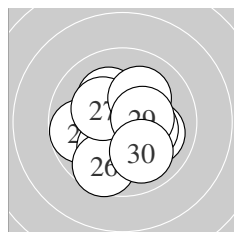

Serie 3:
 10.0 ↘ 10.2 * 9.8 ← 10.1 ↓ 10.2 *
 9.6 ↓ 10.3 * 10.1 ↗ 10.4 * 10.0 ↓
 beste Teiler 142.7 (29.) 169.1 (27.) 176.5 (22.)
 Trefferlage 0.01 mm rechts, 0.42 mm tief
 Streuwert 1.66, horizontal: 1.73, vertikal: 1.59

Unterschrift des Schützen

Meyton Elektronik

Ergebnis: **302.6** (288)
 Serien: 100.4 100.9 101.3
 Zähler: 19 10 1 0 0 0 0 0 0 0
 Innenzehner: 14
 weiteste: 552 (1), 359 (22), 331 (11)
 beste Teiler 54.7 (15.) 62.0 (23.) 67.3 (5.)
 Trefferlage 0.49 mm links, 0.48 mm tief
 Streuwert 1.65, horizontal: 1.87, vertikal: 1.40

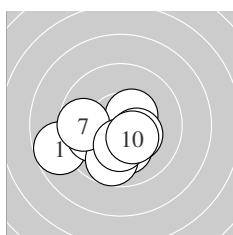
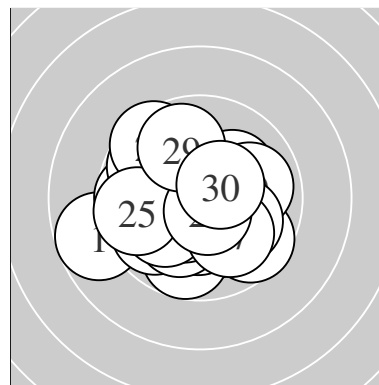

Serie 1:
 8.7 ← 9.9 ← 10.2 * 9.7 ↓ 10.7 *
 10.5 * 9.7 ← 10.3 * 10.3 * 10.4 *
 beste Teiler 67.3 (5.) 124.6 (6.) 144.2 (10.)
 Trefferlage 0.77 mm links, 1.10 mm tief
 Streuwert 1.69, horizontal: 2.13, vertikal: 1.08

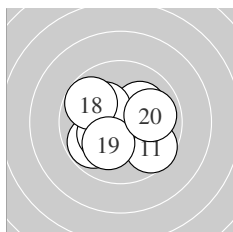

Serie 2:
 9.6 ↘ 9.8 ↗ 10.5 * 10.2 * 10.7 *
 10.1 ↗ 10.2 * 9.8 ↖ 10.1 ↓ 9.9 →
 beste Teiler 54.7 (15.) 115.4 (13.) 178.3 (14.)
 Trefferlage 0.31 mm links, 0.20 mm tief
 Streuwert 1.67, horizontal: 1.90, vertikal: 1.39

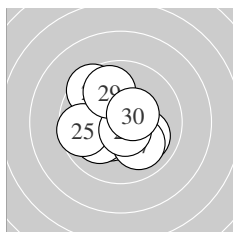

Serie 3:
 10.4 * 9.5 ↘ 10.7 * 10.1 ↙ 9.6 ←
 10.0 ↘ 10.0 ↘ 10.6 * 9.9 ↗ 10.5 *
 beste Teiler 62.0 (23.) 77.5 (28.) 123.7 (30.)
 Trefferlage 0.41 mm links, 0.13 mm tief
 Streuwert 1.65, horizontal: 1.71, vertikal: 1.59

Unterschrift des Schützen

Meyton Elektronik

Ergebnis: **281.0** (267)
 Serien: 94.1 91.7 95.2
 Zähler: 9 15 3 1 1 1 0 0 0 0
 Innenzehner: 6
 weiteste: 1324 (27), 1150 (1), 940 (18)
 beste Teiler 47.2 (22.) 89.0 (24.) 126.1 (12.)
 Trefferlage 1.75 mm links, 1.27 mm hoch
 Streuwert 3.17, horizontal: 3.16, vertikal: 3.18

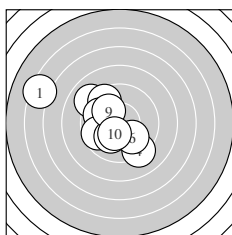
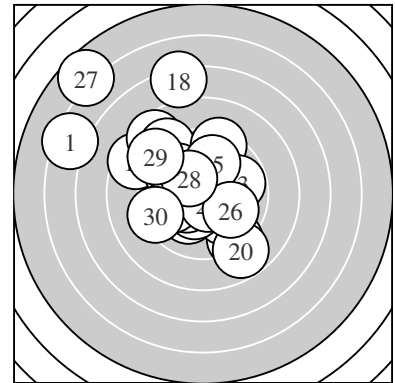

Serie 1:
 6.4 ↘ 9.0 ↘ 9.5 ↘ 9.2 ↘ 9.8 ↘
 10.0 ↘ 9.7 ↙ 10.1 ↗ 10.1 ↘ 10.3 *
 beste Teiler 155.6 (10.) 212.4 (8.) 220.3 (9.)
 Trefferlage 2.11 mm links, 0.29 mm hoch
 Streuwert 3.16, horizontal: 3.60, vertikal: 2.63

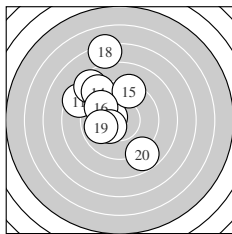

Serie 2:
 8.5 ↘ 10.4 * 8.6 ↘ 9.0 ↘ 9.3 ↑
 9.7 ↘ 10.3 * 7.2 ↑ 9.9 ↙ 8.8 ↘
 beste Teiler 126.1 (12.) 155.8 (17.) 264.0 (19.)
 Trefferlage 1.73 mm links, 1.99 mm hoch
 Streuwert 3.16, horizontal: 2.42, vertikal: 3.75

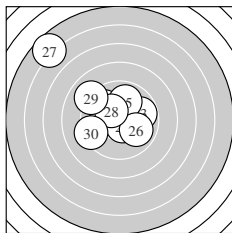

Serie 3:
 9.9 ↘ 10.8 * 9.8 → 10.6 * 9.9 ↑
 9.9 ↘ 5.7 ↘ 10.3 * 9.0 ↘ 9.3 ↙
 beste Teiler 47.2 (22.) 89.0 (24.) 166.4 (28.)
 Trefferlage 1.40 mm links, 1.54 mm hoch
 Streuwert 3.38, horizontal: 3.60, vertikal: 3.15

Unterschrift des Schützen

Ergebnis: **302.2** (290)
 Serien: 102.0 100.5 99.7
 Zähler: 20 10 0 0 0 0 0 0 0 0
 Innenzehner: 12
 weiteste: 398 (24), 377 (19), 351 (29)
 beste Teiler 61.5 (13.) 83.8 (22.) 87.6 (16.)
 Trefferlage 0.13 mm links, 0.51 mm tief
 Streuwert 1.64, horizontal: 1.66, vertikal: 1.61

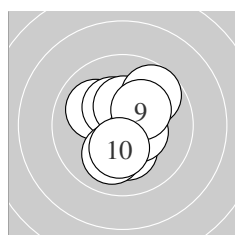
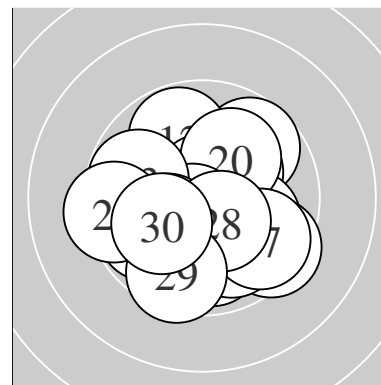

Serie 1:
 10.2 * 10.0 ↖ 10.4 * 10.3 * 10.4 *
 10.5 * 10.0 ↓ 9.7 ↗ 10.2 * 10.3 *
 beste Teiler 125.3 (6.) 128.4 (3.) 141.1 (5.)
 Trefferlage 0.20 mm rechts, 0.20 mm hoch
 Streuwert 1.42, horizontal: 1.22, vertikal: 1.60

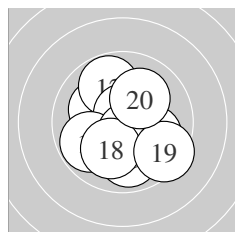

Serie 2:
 10.1 ↖ 9.8 ↗ 10.7 * 9.8 ↙ 9.9 ↓
 10.6 * 10.0 ↘ 10.1 ↓ 9.4 ↘ 10.1 ↗
 beste Teiler 61.5 (13.) 87.6 (16.) 201.2 (11.)
 Trefferlage 0.13 mm rechts, 0.39 mm tief
 Streuwert 1.76, horizontal: 1.73, vertikal: 1.79

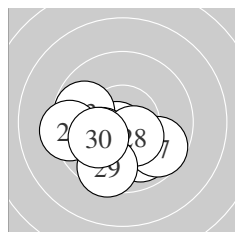

Serie 3:
 10.1 ↓ 10.6 * 9.8 ↖ 9.4 ← 10.2 *
 9.9 ↘ 9.7 ↘ 10.4 * 9.5 ↓ 10.1 ↙
 beste Teiler 83.8 (22.) 132.4 (28.) 193.6 (25.)
 Trefferlage 0.73 mm links, 1.34 mm tief
 Streuwert 1.60, horizontal: 1.96, vertikal: 1.12

Unterschrift des Schützen

Meyton Elektronik

Ergebnis: **309.6** (297)
 Serien: 101.1 104.2 104.3
 Zähler: 27 3 0 0 0 0 0 0 0 0
 Innenzehner: 23
 weiteste: 387 (5), 331 (1), 277 (4)
 beste Teiler 40.8 (11.) 46.2 (24.) 67.6 (13.)
 Trefferlage 0.04 mm links, 0.40 mm tief
 Streuwert 1.23, horizontal: 1.29, vertikal: 1.18

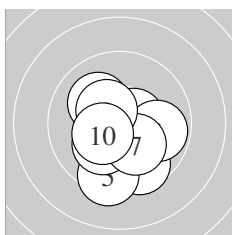
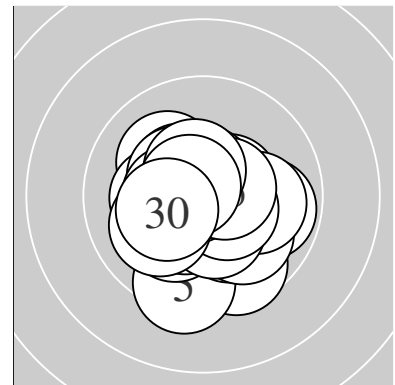

Serie 1:
 9.6 ↘ 10.5 * 10.5 * 9.8 → 9.4 ↓
 10.2 * 10.2 * 10.1 ↖ 10.4 * 10.4 *
 beste Teiler 105.0 (2.) 107.2 (3.) 133.6 (9.)
 Trefferlage 0.05 mm rechts, 0.95 mm tief
 Streuwert 1.55, horizontal: 1.45, vertikal: 1.63

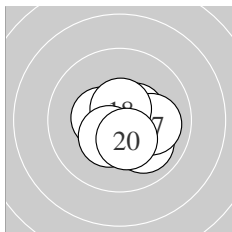

Serie 2:
 10.8 * 10.4 * 10.7 * 10.0 ↘ 10.4 *
 10.5 * 10.0 → 10.6 * 10.4 * 10.4 *
 beste Teiler 40.8 (11.) 67.6 (13.) 82.3 (18.)
 Trefferlage 0.51 mm rechts, 0.29 mm tief
 Streuwert 1.00, horizontal: 1.13, vertikal: 0.84

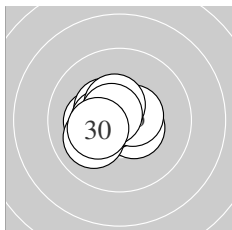

Serie 3:
 10.2 * 10.5 * 10.4 * 10.8 * 10.5 *
 10.4 * 10.5 * 10.0 ↙ 10.7 * 10.3 *
 beste Teiler 46.2 (24.) 73.0 (29.) 101.5 (25.)
 Trefferlage 0.71 mm links, 0.03 mm hoch
 Streuwert 0.90, horizontal: 1.06, vertikal: 0.71

Unterschrift des Schützen

Ergebnis: **311.6** (297)
 Serien: 104.2 103.8 103.6
 Zähler: 27 3 0 0 0 0 0 0 0 0
 Innenzehner: 23
 weiteste: 312 (10), 259 (23), 257 (27)
 beste Teiler 41.0 (9.) 43.8 (22.) 48.6 (5.)
 Trefferlage 0.31 mm rechts, 0.27 mm tief
 Streuwert 1.10, horizontal: 1.11, vertikal: 1.08

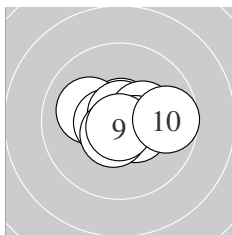
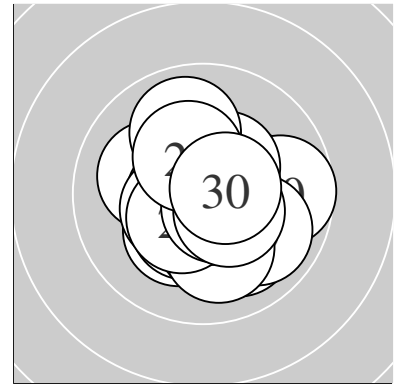

Serie 1:
 10.7 * 10.1 ← 10.1 → 10.6 * 10.8 *
 10.3 * 10.5 * 10.6 * 10.8 * 9.7 →
 beste Teiler 41.0 (9.) 48.6 (5.) 63.7 (1.)
 Trefferlage 0.46 mm rechts, 0.06 mm hoch
 Streuwert 1.13, horizontal: 1.50, vertikal: 0.53

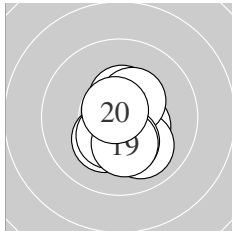

Serie 2:
 10.4 * 10.0 ↘ 10.5 * 10.7 * 10.2 *
 10.4 * 10.3 * 10.4 * 10.2 * 10.7 *
 beste Teiler 56.3 (20.) 69.0 (14.) 125.0 (13.)
 Trefferlage 0.24 mm rechts, 0.64 mm tief
 Streuwert 1.00, horizontal: 0.77, vertikal: 1.18

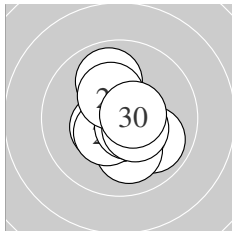

Serie 3:
 10.5 * 10.8 * 9.9 ↘ 10.1 ↓ 10.4 *
 10.6 * 9.9 ↑ 10.5 * 10.3 * 10.6 *
 beste Teiler 43.8 (22.) 77.1 (26.) 92.8 (30.)
 Trefferlage 0.23 mm rechts, 0.23 mm tief
 Streuwert 1.21, horizontal: 1.04, vertikal: 1.36

Unterschrift des Schützen