

Ergebnis: **386.4** (367)
 Serien: 95.8 96.9 98.9 94.8
 Zähler: 15 17 8 0 0 0 0 0 0 0
 Innenzehner: 13
 Weitester: 695 (27.), 667 (14.), 653 (32.)
 beste Teiler: 68.3 (21.), 74.0 (30.), 82.0 (19.)
 Trefferlage: 0.06 mm links, 0.57 mm hoch
 Streuwert: 2.60, horizontal: 3.14, vertikal: 1.91

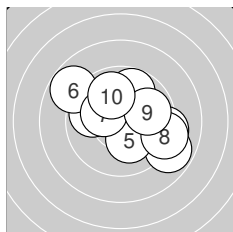

Serie 1:
 9.8 ↗ 8.8 ↘ 9.2 → 9.8 ← 10.2 *
 8.8 ↖ 10.2 * 9.2 → 9.9 → 9.9 ↗

beste Teiler: 177.1 (7.), 192.3 (5.), 262.2 (10.)
 Trefferlage: 0.77 mm rechts, 0.41 mm hoch
 Streuwert: 2.64, horizontal: 3.15, vertikal: 2.00

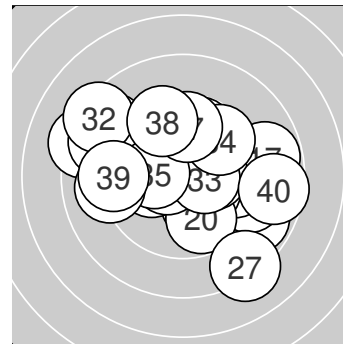
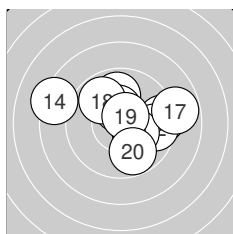

Serie 2:
 9.4 → 9.6 → 10.3 * 8.3 ← 9.9 ↗
 10.4 * 8.8 → 9.8 ↘ 10.6 * 9.8 ↘

beste Teiler: 82.0 (19.), 142.3 (16.), 170.3 (13.)
 Trefferlage: 0.68 mm rechts, 0.66 mm hoch
 Streuwert: 2.58, horizontal: 3.26, vertikal: 1.63

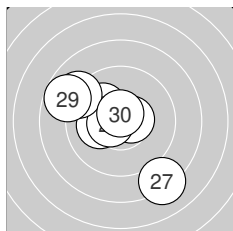

Serie 3:
 10.7 * 10.1 ↖ 10.2 * 10.6 * 10.1 ←
 10.5 * 8.2 ↘ 9.1 ↖ 8.7 ↖ 10.7 *

beste Teiler: 68.3 (21.), 74.0 (30.), 100.2 (24.)
 Trefferlage: 1.13 mm links, 0.10 mm hoch
 Streuwert: 2.40, horizontal: 2.52, vertikal: 2.27

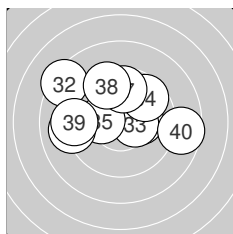

Serie 4:
 10.2 * 8.3 ↖ 10.4 * 9.6 ↗ 10.2 *
 9.1 ← 9.7 ↑ 9.5 ↗ 9.2 ← 8.6 →

beste Teiler: 138.6 (33.), 182.8 (35.), 188.2 (31.)
 Trefferlage: 0.59 mm links, 1.12 mm hoch
 Streuwert: 2.85, horizontal: 3.59, vertikal: 1.82



Ergebnis: **372.3** (354)
 Serien: 87.7 92.6 95.5 96.5
 Zähler: 10 17 10 3 0 0 0 0 0 0
 Innenzehner: 8
 Weitester: 993 (1.), 800 (17.), 756 (4.)
 beste Teiler: 90.1 (37.), 98.4 (11.), 123.8 (9.)
 Trefferlage: 0.99 mm rechts, 0.78 mm tief
 Streuwert: 3.19, horizontal: 3.97, vertikal: 2.14

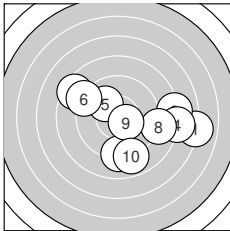
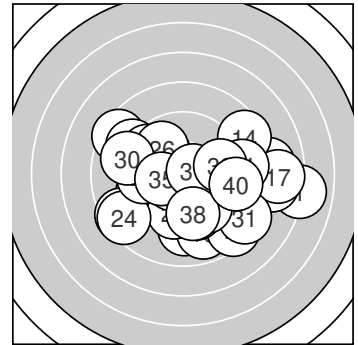

Serie 1:

7.0 →	8.1 →	8.4 ↖	7.9 →	10.0 ↘
9.0 ↖	9.1 ↓	8.8 →	10.5 *	8.9 ↓

beste Teiler: 123.8 (9.), 230.0 (5.), 462.1 (7.)
 Trefferlage: 2.13 mm rechts, 0.56 mm tief
 Streuwert: 4.12, horizontal: 5.16, vertikal: 2.72

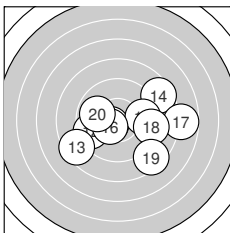

Serie 2:

10.6 *	9.5 ↖	8.5 ↖	8.5 ↗	9.7 →
10.5 *	7.8 →	9.2 →	8.4 ↘	9.9 ↖

beste Teiler: 98.4 (11.), 124.9 (16.), 268.2 (20.)
 Trefferlage: 1.19 mm rechts, 0.75 mm tief
 Streuwert: 3.42, horizontal: 4.33, vertikal: 2.16

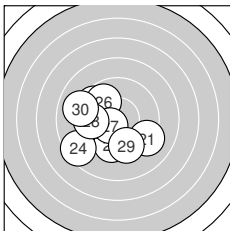

Serie 3:

9.2 ↘	9.6 ↓	9.5 ↖	8.5 ↖	10.2 *
9.8 ↖	10.5 *	9.6 ←	9.6 ↓	9.0 ↖

beste Teiler: 125.4 (27.), 196.7 (25.), 282.3 (26.)
 Trefferlage: 1.66 mm links, 0.84 mm tief
 Streuwert: 2.44, horizontal: 2.63, vertikal: 2.23

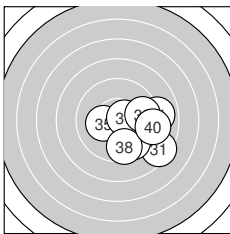

Serie 4:

8.4 ↘	9.6 ↓	10.3 *	8.9 →	10.2 *
10.1 →	10.6 *	9.6 ↓	9.7 →	9.1 →

beste Teiler: 90.1 (37.), 159.0 (33.), 184.3 (35.)
 Trefferlage: 2.32 mm rechts, 0.99 mm tief
 Streuwert: 1.93, horizontal: 2.18, vertikal: 1.64



Ergebnis: **377.6** (361)
 Serien: 91.3 93.6 93.6 99.1
 Zähler: 15 13 10 2 0 0 0 0 0 0
 Innenzehner: 13
 Weitester: 949 (11.), 866 (9.), 714 (31.)
 beste Teiler: 70.3 (29.), 77.4 (24.), 96.6 (17.)
 Trefferlage: 1.05 mm rechts, 0.97 mm hoch
 Streuwert: 2.97, horizontal: 3.30, vertikal: 2.60

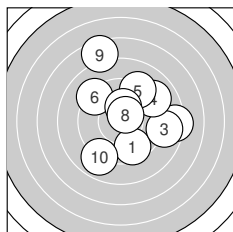
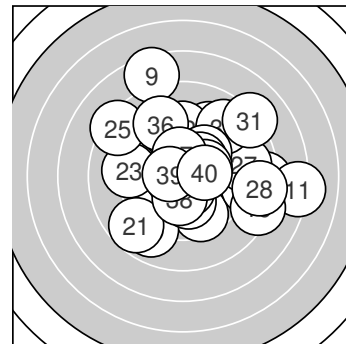

Serie 1:
 9.6 ↘ 8.3 → 8.8 → 9.0 ↗ 9.2 ↗
 9.2 ↙ 10.2 * 10.6 * 7.5 ↗ 8.9 ↘
 beste Teiler: 99.2 (8.), 178.8 (7.), 343.5 (1.)
 Trefferlage: 1.21 mm rechts, 1.18 mm hoch
 Streuwert: 3.53, horizontal: 3.42, vertikal: 3.65

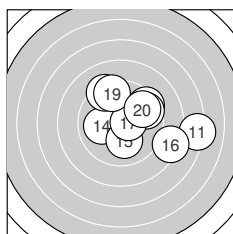

Serie 2:
 7.2 → 9.4 ↗ 9.6 ↗ 10.0 ← 10.1 ↓
 8.3 ↘ 10.6 * 9.3 ↘ 9.4 ↗ 9.7 ↘
 beste Teiler: 96.6 (17.), 213.0 (15.), 233.3 (14.)
 Trefferlage: 2.05 mm rechts, 0.69 mm hoch
 Streuwert: 3.05, horizontal: 3.69, vertikal: 2.24

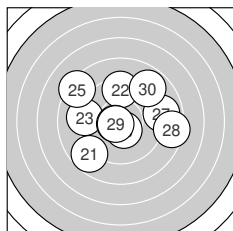

Serie 3:
 8.7 ↗ 9.4 ↑ 9.2 ← 10.6 * 8.3 ↙
 10.5 * 8.9 → 8.4 → 10.7 * 8.9 ↗
 beste Teiler: 70.3 (29.), 77.4 (24.), 115.7 (26.)
 Trefferlage: 0.00 mm , 0.65 mm hoch
 Streuwert: 3.35, horizontal: 3.93, vertikal: 2.63

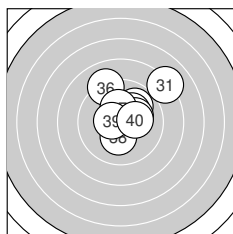

Serie 4:
 8.1 ↗ 9.9 ↗ 10.2 * 10.5 * 10.2 *
 9.1 ↘ 10.2 * 10.2 * 10.5 * 10.2 *
 beste Teiler: 102.0 (34.), 109.3 (39.), 178.2 (37.)
 Trefferlage: 0.95 mm rechts, 1.38 mm hoch
 Streuwert: 1.98, horizontal: 2.04, vertikal: 1.92



Ergebnis: **371.3** (354)
 Serien: 95.4 91.5 94.3 90.1
 Zähler: 11 19 5 3 2 0 0 0 0 0
 Innenzehner: 7
 Weitester: 1095 (15.), 1038 (7.), 930 (34.)
 beste Teiler: 66.4 (19.), 81.6 (8.), 106.3 (17.)
 Trefferlage: 0.82 mm links, 1.17 mm tief
 Streuwert: 3.35, horizontal: 3.82, vertikal: 2.81

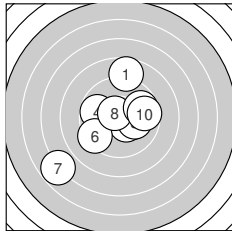
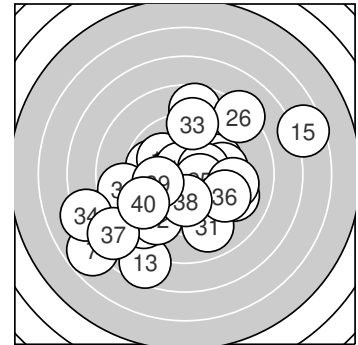

Serie 1:
 8.7 ↑ 10.3 * 10.4 * 9.8 ← 10.1 →
 9.3 ↙ 6.8 ↙ 10.6 * 9.8 → 9.6 →
 beste Teiler: 81.6 (8.), 130.3 (3.), 174.3 (2.)
 Trefferlage: 0.35 mm links, 0.26 mm tief
 Streuwert: 3.27, horizontal: 3.47, vertikal: 3.07

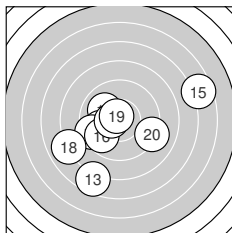

Serie 2:
 10.0 ↘ 9.9 ← 7.6 ↓ 9.4 ← 6.6 →
 9.7 ↙ 10.5 * 8.0 ← 10.7 * 9.1 →
 beste Teiler: 66.4 (19.), 106.3 (17.), 234.6 (11.)
 Trefferlage: 0.74 mm links, 1.19 mm tief
 Streuwert: 4.00, horizontal: 4.76, vertikal: 3.04

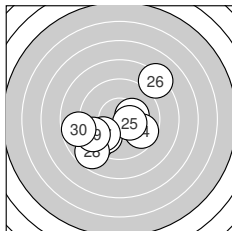

Serie 3:
 10.3 * 9.2 ↙ 9.8 ↙ 9.7 ↘ 10.4 *
 8.2 ↗ 9.8 ↙ 8.7 ↙ 9.4 ↙ 8.8 ←
 beste Teiler: 139.5 (25.), 167.7 (21.), 289.5 (27.)
 Trefferlage: 0.90 mm links, 1.13 mm tief
 Streuwert: 2.92, horizontal: 3.28, vertikal: 2.51

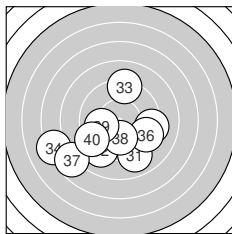

Serie 4:
 9.0 ↓ 9.1 ↙ 9.2 ↑ 7.2 ← 9.3 →
 9.4 ↘ 7.7 ↙ 10.0 ↓ 10.0 ← 9.2 ↙
 beste Teiler: 230.1 (38.), 246.0 (39.), 395.6 (36.)
 Trefferlage: 1.28 mm links, 2.09 mm tief
 Streuwert: 3.50, horizontal: 4.14, vertikal: 2.72



Ergebnis: **358.5** (340)
 Serien: 90.5 88.6 89.2 90.2
 Zähler: 5 22 5 5 2 1 0 0 0 0
 Innenzehner: 3
 Weitester: 1378 (2.), 1035 (30.), 1010 (3.)
 beste Teiler: 110.4 (1.), 136.3 (12.), 141.3 (5.)
 Trefferlage: 0.01 mm links, 0.74 mm tief
 Streuwert: 4.03, horizontal: 4.28, vertikal: 3.77

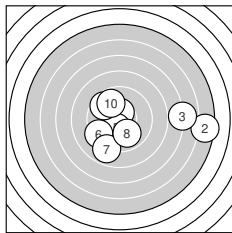
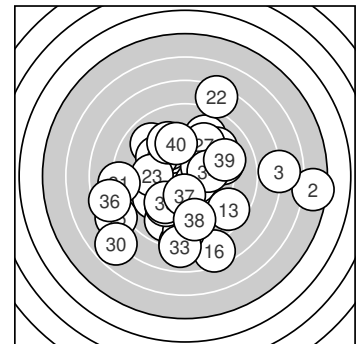

Serie 1:

10.5 *	5.4 →	6.9 →	9.8 ↙	10.4 *
9.3 ↙	8.9 ↙	9.9 ↘	9.6 ↘	9.8 ↗

beste Teiler: 110.4 (1.), 141.3 (5.), 253.6 (8.)
 Trefferlage: 1.34 mm rechts, 0.80 mm tief
 Streuwert: 4.40, horizontal: 5.78, vertikal: 2.31

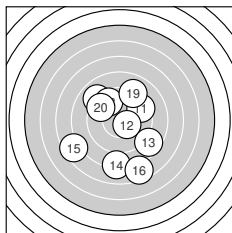

Serie 2:

9.4 ↗	10.4 *	8.6 ↘	8.1 ↓	7.5 ↙
7.5 ↘	9.0 ↘	9.6 ↗	9.0 ↗	9.5 ↘

beste Teiler: 136.3 (12.), 340.4 (18.), 365.0 (20.)
 Trefferlage: 0.17 mm links, 0.92 mm tief
 Streuwert: 4.18, horizontal: 3.78, vertikal: 4.55

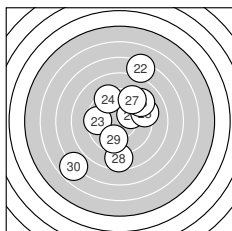

Serie 3:

10.1 ↗	7.3 ↑	9.5 ←	9.4 ↘	9.3 →
9.1 ↗	9.4 ↑	8.6 ↓	9.7 ↓	6.8 ↙

beste Teiler: 208.0 (21.), 301.0 (29.), 352.1 (23.)
 Trefferlage: 0.08 mm rechts, 0.50 mm hoch
 Streuwert: 4.21, horizontal: 3.61, vertikal: 4.73

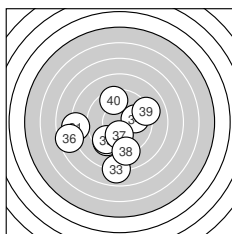

Serie 4:

8.1 ←	9.5 ↙	7.9 ↓	9.9 →	9.5 ↙
7.6 ←	10.1 ↓	9.0 ↓	9.1 →	9.5 ↑

beste Teiler: 203.0 (37.), 253.6 (34.), 351.4 (35.)
 Trefferlage: 1.30 mm links, 1.77 mm tief
 Streuwert: 3.53, horizontal: 3.84, vertikal: 3.18



Ergebnis: **339.0** (322)
 Serien: 82.7 77.8 87.3 91.2
 Zähler: 7 8 12 9 1 3 0 0 0 0
 Innenzehner: 3
 Weitester: 1491 (4.), 1395 (20.), 1282 (13.)
 beste Teiler: 72.4 (37.), 157.7 (31.), 169.2 (38.)
 Trefferlage: 0.19 mm links, 0.91 mm tief
 Streuwert: 4.99, horizontal: 4.45, vertikal: 5.48

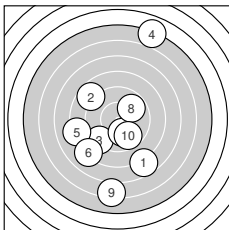
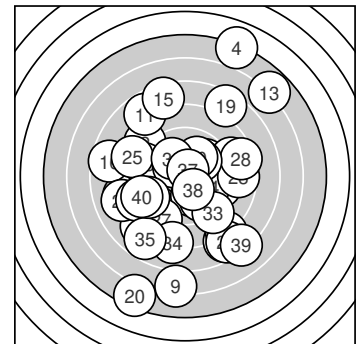

Serie 1:

7.7 ↘	8.7 ↖	9.2 ↗	5.0 ↗	8.2 ↖
8.1 ↗	10.1 ↘	9.8 ↖	6.2 ↘	9.7 ↘

beste Teiler: 222.9 (7.), 283.7 (8.), 312.6 (10.)
 Trefferlage: 0.51 mm links, 1.51 mm tief
 Streuwert: 5.68, horizontal: 4.06, vertikal: 6.92

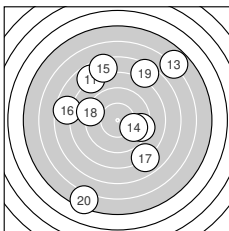

Serie 2:

7.8 ↖	9.4 →	5.8 ↗	9.8 →	7.5 ↗
7.6 ↖	7.9 ↘	9.1 ↖	7.5 ↗	5.4 ↘

beste Teiler: 285.1 (14.), 396.6 (12.), 460.2 (18.)
 Trefferlage: 0.02 mm links, 1.34 mm hoch
 Streuwert: 6.36, horizontal: 5.60, vertikal: 7.04

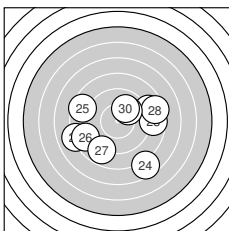

Serie 3:

8.8 →	8.0 ↖	8.6 →	7.6 ↘	8.5 ↖
8.6 ↖	8.8 ↘	8.4 →	10.0 ↗	10.0 ↗

beste Teiler: 239.0 (29.), 240.3 (30.), 529.9 (27.)
 Trefferlage: 0.41 mm rechts, 0.73 mm tief
 Streuwert: 4.27, horizontal: 5.06, vertikal: 3.31

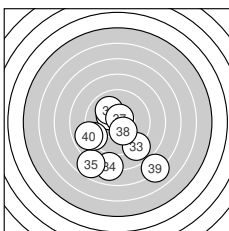

Serie 4:

10.3 *	10.0 ↖	9.0 ↘	8.0 ↓	7.8 ↘
9.1 ↖	10.7 *	10.3 *	7.1 ↘	8.9 ↖

beste Teiler: 72.4 (37.), 157.7 (31.), 169.2 (38.)
 Trefferlage: 0.64 mm links, 2.76 mm tief
 Streuwert: 3.43, horizontal: 3.39, vertikal: 3.47



Ergebnis: **359.8** (346)
 Serien: 87.1 92.7 94.1 85.9
 Zähler: 11 17 6 1 3 2 0 0 0 0
 Innenzehner: 5
 Weitester: 1322 (5.), 1292 (33.), 1239 (36.)
 beste Teiler: 107.0 (1.), 164.9 (31.), 183.2 (10.)
 Trefferlage: 1.45 mm rechts, 1.29 mm tief
 Streuwert: 3.97, horizontal: 4.98, vertikal: 2.58

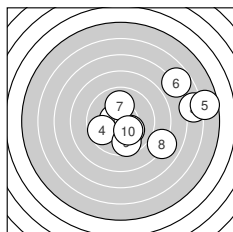
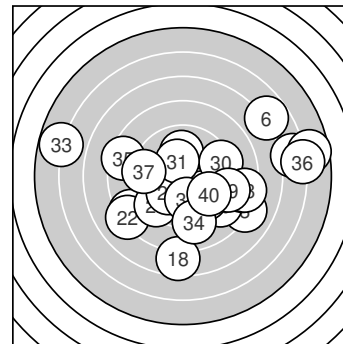

Serie 1:
 10.5 * 10.2 * 6.4 → 9.7 ← 5.7 →
 6.8 ↗ 10.0 ↑ 8.0 ↘ 9.6 ↓ 10.2 *
 beste Teiler: 107.0 (1.), 183.2 (10.), 195.3 (2.)
 Trefferlage: 3.86 mm rechts, 0.26 mm hoch
 Streuwert: 4.43, horizontal: 5.51, vertikal: 2.98

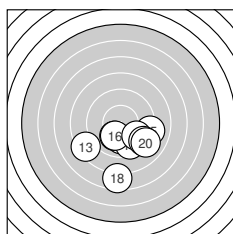

Serie 2:
 10.0 ↓ 10.1 ↙ 8.4 ↖ 9.5 ↓ 9.1 →
 10.1 ↙ 9.7 ↘ 7.6 ↓ 9.2 ↘ 9.0 ↘
 beste Teiler: 209.9 (16.), 216.8 (12.), 246.0 (11.)
 Trefferlage: 0.81 mm rechts, 3.04 mm tief
 Streuwert: 2.56, horizontal: 2.99, vertikal: 2.05

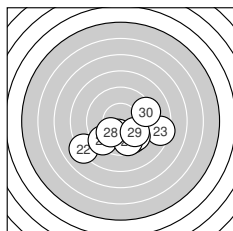

Serie 3:
 9.7 ↘ 8.1 ↖ 8.4 → 9.6 ↘ 10.2 *
 9.3 ↗ 9.6 ↓ 10.0 ↖ 9.9 ↘ 9.3 →
 beste Teiler: 197.4 (25.), 228.7 (28.), 275.4 (29.)
 Trefferlage: 0.70 mm rechts, 2.06 mm tief
 Streuwert: 2.63, horizontal: 3.41, vertikal: 1.48

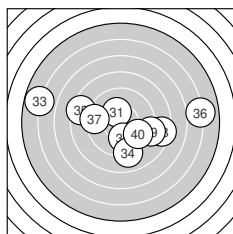

Serie 4:
 10.3 * 10.0 ↓ 5.8 ← 9.0 ↓ 8.4 ←
 6.0 → 9.3 ← 8.4 → 9.0 → 9.7 ↘
 beste Teiler: 164.9 (31.), 241.0 (32.), 323.9 (40.)
 Trefferlage: 0.42 mm rechts, 0.32 mm tief
 Streuwert: 5.18, horizontal: 6.92, vertikal: 2.42



Ergebnis: **364.7** (346)
 Serien: 92.7 91.6 89.9 90.5
 Zähler: 7 19 8 5 1 0 0 0 0 0
 Innenzehner: 3
 Weitester: 1054 (40.), 946 (19.), 907 (32.)
 beste Teiler: 118.2 (36.), 122.1 (16.), 178.6 (37.)
 Trefferlage: 0.72 mm rechts, 0.09 mm tief
 Streuwert: 3.64, horizontal: 4.45, vertikal: 2.58

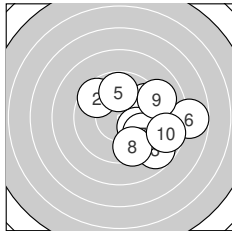
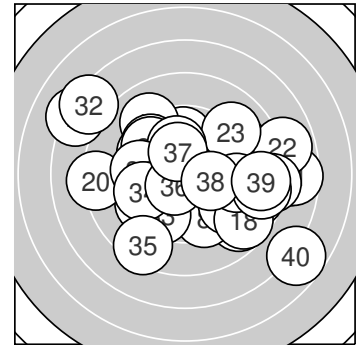

Serie 1:
 9.6 ↗ 9.6 ↘ 8.8 ↘ 10.1 ↘ 9.8 ↑
 7.8 → 9.7 ↘ 9.5 ↓ 9.1 ↗ 8.7 →
 beste Teiler: 223.5 (4.), 289.3 (5.), 314.5 (7.)
 Trefferlage: 2.79 mm rechts, 0.30 mm tief
 Streuwert: 2.68, horizontal: 2.93, vertikal: 2.39

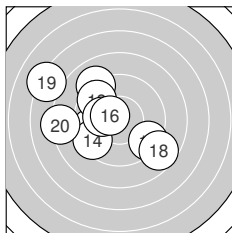

Serie 2:
 9.6 ← 9.0 ↘ 9.6 ↘ 9.4 ← 10.1 ←
 10.5 * 9.3 ↘ 8.7 ↘ 7.2 ↘ 8.2 ←
 beste Teiler: 122.1 (16.), 202.0 (15.), 331.8 (11.)
 Trefferlage: 2.21 mm links, 0.21 mm hoch
 Streuwert: 3.35, horizontal: 3.91, vertikal: 2.67

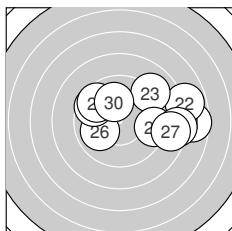

Serie 3:
 7.6 → 7.9 → 9.0 ↗ 9.4 → 8.3 →
 9.9 ← 8.6 → 9.6 ↘ 9.6 ↘ 10.0 ↑
 beste Teiler: 229.1 (30.), 252.2 (26.), 337.6 (29.)
 Trefferlage: 2.72 mm rechts, 0.75 mm hoch
 Streuwert: 3.36, horizontal: 4.44, vertikal: 1.66

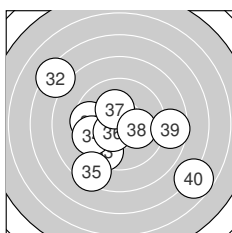

Serie 4:
 9.6 ← 7.3 ↘ 9.5 ↘ 9.6 ← 8.4 ↘
 10.5 * 10.2 * 10.1 → 8.6 → 6.7 ↘
 beste Teiler: 118.2 (36.), 178.6 (37.), 203.7 (38.)
 Trefferlage: 0.40 mm links, 1.06 mm tief
 Streuwert: 4.08, horizontal: 4.70, vertikal: 3.35



Ergebnis: **333.3** (316)
 Serien: 83.7 76.5 82.5 90.6
 Zähler: 3 14 7 9 6 1 0 0 0 0
 Innenzehner: 1
 Weitester: 1305 (23.), 1232 (10.), 1202 (12.)
 beste Teiler: 175.2 (33.), 206.6 (2.), 223.6 (31.)
 Trefferlage: 0.11 mm links, 2.39 mm hoch
 Streuwert: 4.94, horizontal: 5.69, vertikal: 4.06

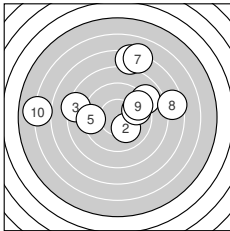
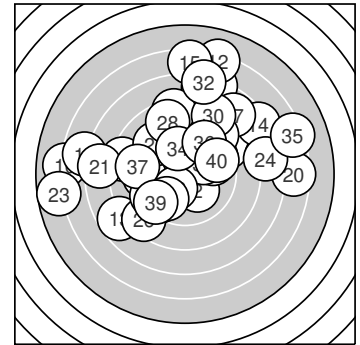

Serie 1:

8.9 ↗	10.1 ↘	8.3 ←	7.3 ↑	9.3 ←
9.7 →	7.1 ↑	7.5 →	9.5 →	6.0 ←

beste Teiler: 206.6 (2.), 307.0 (6.), 363.7 (9.)
 Trefferlage: 0.21 mm rechts, 2.59 mm hoch
 Streuwert: 4.97, horizontal: 6.06, vertikal: 3.56

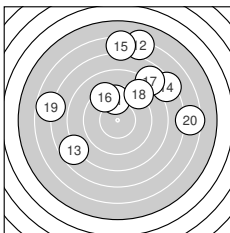

Serie 2:

9.7 ↑	6.1 ↑	7.7 ↙	7.3 ↗	6.4 ↑
9.3 ↘	7.8 ↗	8.9 ↗	6.8 ←	6.5 →

beste Teiler: 315.9 (11.), 402.4 (16.), 514.7 (18.)
 Trefferlage: 1.13 mm rechts, 4.23 mm hoch
 Streuwert: 5.67, horizontal: 6.39, vertikal: 4.84

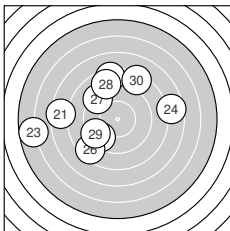

Serie 3:

7.5 ←	9.4 ↙	5.7 ←	7.6 →	8.3 ↑
8.5 ↙	9.2 ↘	8.7 ↑	9.3 ↙	8.3 ↑

beste Teiler: 378.4 (22.), 403.0 (29.), 434.8 (27.)
 Trefferlage: 2.66 mm links, 1.17 mm hoch
 Streuwert: 4.95, horizontal: 5.75, vertikal: 3.99

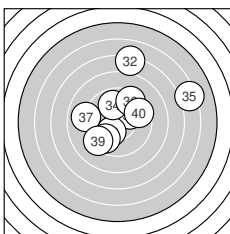

Serie 4:

10.1 ↗	7.1 ↑	10.3 *	9.9 ↑	6.3 →
9.4 ↗	9.0 ←	9.7 ↙	9.3 ↙	9.5 →

beste Teiler: 175.2 (33.), 223.6 (31.), 271.9 (34.)
 Trefferlage: 0.86 mm rechts, 1.58 mm hoch
 Streuwert: 4.02, horizontal: 4.39, vertikal: 3.62



Ergebnis: **405.4** (386)
 Serien: 102.3 99.1 101.0 103.0
 Zähler: 26 14 0 0 0 0 0 0 0
 Innenzehner: 23
 Weitest: 415 (13.), 411 (12.), 405 (11.)
 beste Teiler: 50.6 (14.), 71.5 (38.), 77.7 (7.)
 Trefferlage: 0.13 mm rechts, 0.10 mm hoch
 Streuwert: 1.63, horizontal: 1.74, vertikal: 1.51

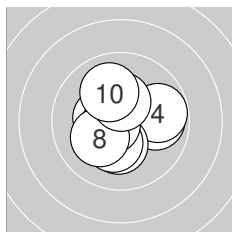
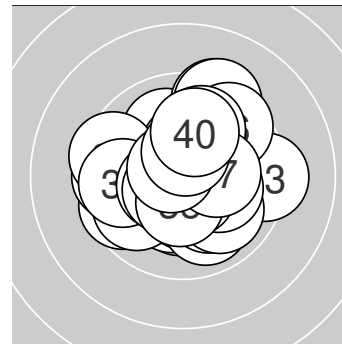

Serie 1:

10.4 *	10.5 *	9.9 →	9.8 →	10.2 *
10.3 *	10.6 *	10.2 *	10.4 *	10.0 ↗

beste Teiler: 77.7 (7.), 112.8 (2.), 142.5 (1.)
 Trefferlage: 0.04 mm links, 0.11 mm tief
 Streuwert: 1.44, horizontal: 1.55, vertikal: 1.32

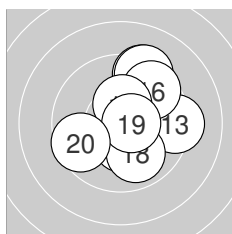

Serie 2:

9.3 ↗	9.3 ↗	9.3 →	10.8 *	10.3 *
9.6 ↗	10.4 *	9.9 ↘	10.6 *	9.6 ↖

beste Teiler: 50.6 (14.), 81.0 (19.), 145.5 (17.)
 Trefferlage: 0.94 mm rechts, 0.57 mm hoch
 Streuwert: 2.02, horizontal: 1.85, vertikal: 2.17

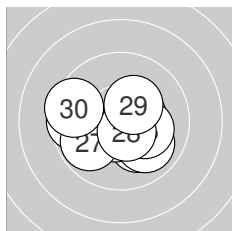

Serie 3:

10.1 ↘	10.6 *	9.9 ↘	10.4 *	10.2 *
9.6 ←	9.8 ↖	10.6 *	10.3 *	9.5 ↖

beste Teiler: 92.2 (28.), 94.4 (22.), 130.2 (24.)
 Trefferlage: 0.19 mm links, 0.45 mm tief
 Streuwert: 1.69, horizontal: 2.13, vertikal: 1.07

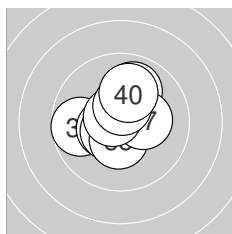

Serie 4:

9.9 ↗	9.7 ←	10.5 *	10.5 *	10.4 *
10.5 *	10.3 *	10.7 *	10.5 *	10.0 ↗

beste Teiler: 71.5 (38.), 105.4 (36.), 108.7 (34.)
 Trefferlage: 0.16 mm links, 0.42 mm hoch
 Streuwert: 1.29, horizontal: 1.34, vertikal: 1.23



Ergebnis: **366.9** (349)
 Serien: 95.6 95.9 85.6 89.8
 Zähler: 8 18 10 3 1 0 0 0 0 0
 Innenzehner: 5
 Weitester: 1135 (27.), 919 (30.), 809 (25.)
 beste Teiler: 99.0 (13.), 105.1 (18.), 107.9 (29.)
 Trefferlage: 1.48 mm rechts, 0.80 mm hoch
 Streuwert: 3.38, horizontal: 3.74, vertikal: 2.96

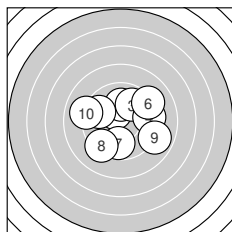
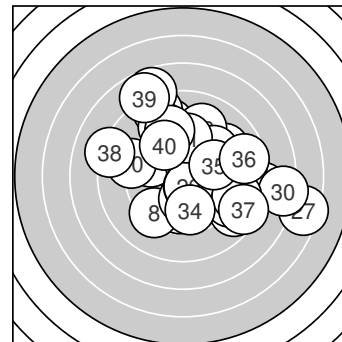

Serie 1:
 10.4 * 10.1 ↑ 9.9 ↗ 9.4 → 9.7 ←
 9.1 ↘ 9.8 ↓ 9.3 ↙ 8.9 ↘ 9.0 ←
 beste Teiler: 133.4 (1.), 225.0 (2.), 272.3 (3.)
 Trefferlage: 0.26 mm rechts, 0.26 mm hoch
 Streuwert: 2.74, horizontal: 3.17, vertikal: 2.24

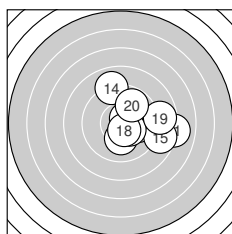

Serie 2:
 8.0 → 10.0 → 10.6 * 9.0 ↑ 8.7 →
 10.1 ↓ 10.4 * 10.5 * 8.8 → 9.8 ↗

beste Teiler: 99.0 (13.), 105.1 (18.), 149.0 (17.)
 Trefferlage: 2.30 mm rechts, 0.15 mm hoch
 Streuwert: 2.45, horizontal: 2.75, vertikal: 2.10

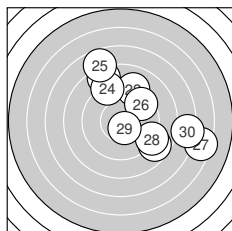

Serie 3:
 8.7 ↘ 9.1 ↑ 8.4 ↖ 9.0 ↑ 7.7 ↖
 9.5 ↗ 6.4 → 9.0 → 10.5 * 7.3 →

beste Teiler: 107.9 (29.), 364.1 (26.), 466.4 (22.)
 Trefferlage: 2.70 mm rechts, 1.36 mm hoch
 Streuwert: 4.36, horizontal: 4.67, vertikal: 4.03

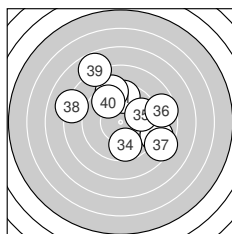

Serie 4:
 9.6 ↑ 9.2 ↑ 8.9 → 9.7 ↓ 9.8 →
 8.6 → 8.4 → 8.2 ← 7.8 ↖ 9.6 ↖

beste Teiler: 298.9 (35.), 312.6 (34.), 326.5 (40.)
 Trefferlage: 0.67 mm rechts, 1.43 mm hoch
 Streuwert: 3.70, horizontal: 4.07, vertikal: 3.28



Ergebnis: **373.9** (360)
 Serien: 91.7 94.3 94.0 93.9
 Zähler: 14 15 9 1 1 0 0 0 0 0
 Innenzehner: 9
 Weitester: 1025 (35.), 944 (13.), 748 (7.)
 beste Teiler: 23.0 (28.), 53.8 (20.), 132.1 (34.)
 Trefferlage: 0.46 mm links, 0.82 mm hoch
 Streuwert: 3.25, horizontal: 4.03, vertikal: 2.21

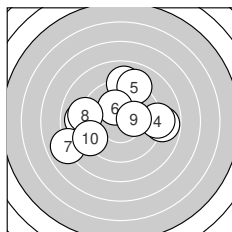
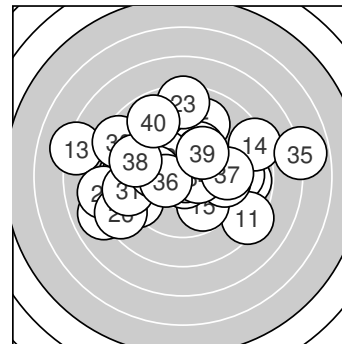

Serie 1:
 9.0 ← 8.8 → 9.0 ↑ 9.1 → 9.0 ↑
 10.2 * 8.0 ← 9.1 ← 10.3 * 9.2 ←
 beste Teiler: 172.8 (9.), 189.7 (6.), 447.1 (10.)
 Trefferlage: 0.69 mm links, 0.66 mm hoch
 Streuwert: 3.47, horizontal: 4.20, vertikal: 2.52

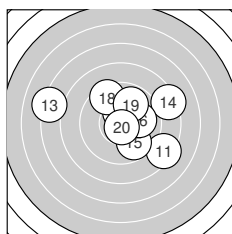

Serie 2:
 8.3 ↘ 10.2 * 7.2 ↖ 8.3 → 9.8 ↘
 10.0 → 10.4 * 9.5 ↘ 9.9 ↗ 10.7 *
 beste Teiler: 53.8 (20.), 140.1 (17.), 199.4 (12.)
 Trefferlage: 0.71 mm rechts, 0.78 mm hoch
 Streuwert: 3.41, horizontal: 4.23, vertikal: 2.31

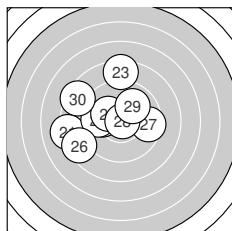

Serie 3:
 8.2 ← 10.0 ← 8.4 ↑ 9.8 ← 10.2 *
 8.5 ← 9.5 → 10.9 * 10.0 ↗ 8.5 ↖
 beste Teiler: 23.0 (28.), 185.2 (25.), 231.9 (22.)
 Trefferlage: 1.90 mm links, 0.76 mm hoch
 Streuwert: 2.97, horizontal: 3.33, vertikal: 2.56

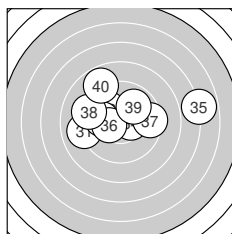

Serie 4:
 9.0 ← 10.0 ↘ 10.0 ← 10.4 * 6.9 →
 10.3 * 9.4 → 9.2 ↖ 9.9 ↗ 8.8 ↘
 beste Teiler: 132.1 (34.), 152.3 (36.), 241.8 (33.)
 Trefferlage: 0.00 mm , 1.07 mm hoch
 Streuwert: 3.34, horizontal: 4.41, vertikal: 1.66



Ergebnis: **268.9** (250)
 Serien: 56.3 79.6 68.3 64.7
 Zähler: 2 5 8 7 4 6 2 2 1 2
 Innenzehner: 0
 Weitestе: 2710 (38.), 2358 (1.), 2282 (9.)
 beste Teiler: 210.0 (40.), 241.1 (22.), 278.4 (11.)
 Trefferlage: 2.22 mm links, 3.05 mm tief
 Streuwert: 8.32, horizontal: 9.08, vertikal: 7.49

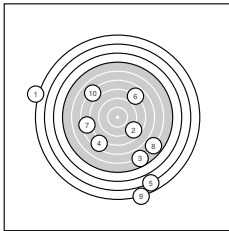
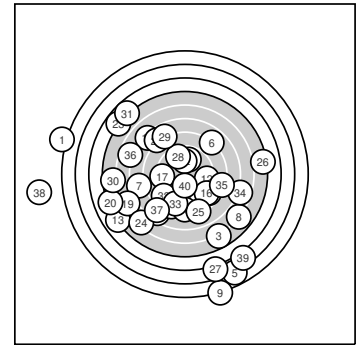

Serie 1:

1.5 ↖	8.7 ↘	5.7 ↘	7.4 ↗	2.8 ↘
7.9 ↗	7.5 ↖	5.9 ↘	1.8 ↘	7.1 ↖

beste Teiler: 565.3 (2.), 764.1 (6.), 875.3 (7.)
 Trefferlage: 0.19 mm links, 5.32 mm tief
 Streuwert: 10.21, horizontal: 10.38, vertikal: 10.03

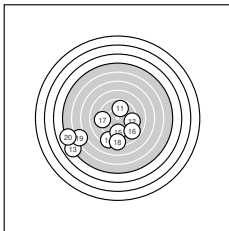

Serie 2:

9.8 ↑	9.3 →	5.0 ↖	8.4 ↘	9.4 ↓
8.8 ↘	9.3 ↖	8.3 ↓	6.2 ↖	5.1 ↖

beste Teiler: 278.4 (11.), 387.1 (15.), 411.6 (12.)
 Trefferlage: 3.45 mm links, 3.74 mm tief
 Streuwert: 5.23, horizontal: 6.60, vertikal: 3.35

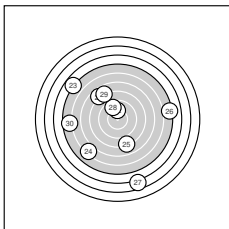

Serie 3:

7.7 ↘	10.0 ↑	4.8 ↘	6.1 ↗	8.0 ↘
5.1 →	3.6 ↓	9.6 ↗	7.8 ↘	5.6 ↖

beste Teiler: 241.1 (22.), 349.2 (28.), 732.9 (25.)
 Trefferlage: 2.14 mm links, 0.40 mm tief
 Streuwert: 8.38, horizontal: 8.39, vertikal: 8.37

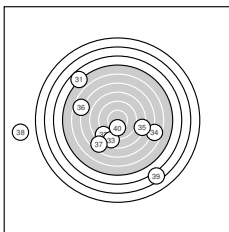

Serie 4:

4.7 ↘	8.7 ↖	8.7 ↓	6.7 →	8.1 →
6.7 ↖	7.6 ↖	0.0 ↖	3.4 ↘	10.1 ↓

beste Teiler: 210.0 (40.), 560.0 (32.), 571.1 (33.)
 Trefferlage: 3.08 mm links, 2.75 mm tief
 Streuwert: 9.36, horizontal: 11.33, vertikal: 6.85



Ergebnis: **337.8** (319)
 Serien: 94.7 78.5 82.9 81.7
 Zähler: 5 15 10 2 5 2 0 0 0 0
 Innenzehner: 2
 Weitestе: 2559 (33.), 1480 (17.), 1401 (14.)
 beste Teiler: 98.3 (1.), 133.2 (31.), 204.2 (19.)
 Trefferlage: 1.57 mm rechts, 0.48 mm tief
 Streuwert: 5.41, horizontal: 6.65, vertikal: 3.79

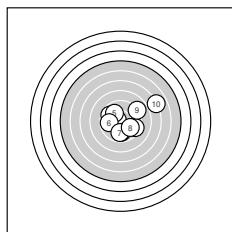
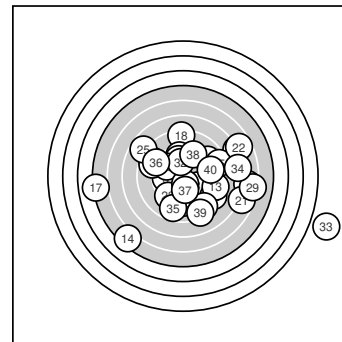

Serie 1:
 10.6 * 9.4 ↘ 9.8 ↓ 9.7 ↖ 9.9 ↖
 9.8 ← 9.8 ↓ 9.8 ↘ 9.0 ↗ 6.9 →

beste Teiler: 98.3 (1.), 254.4 (5.), 279.8 (3.)
 Trefferlage: 1.12 mm rechts, 0.20 mm hoch
 Streuwert: 3.15, horizontal: 3.71, vertikal: 2.47

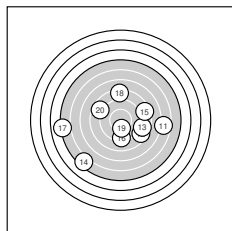

Serie 2:
 6.6 → 8.5 ↘ 8.6 → 5.3 ✓ 8.4 →
 9.2 ↓ 5.0 ← 8.2 ↑ 10.1 ↓ 8.6 ↖

beste Teiler: 204.2 (19.), 447.4 (16.), 577.1 (13.)
 Trefferlage: 0.14 mm links, 1.36 mm tief
 Streuwert: 6.38, horizontal: 7.74, vertikal: 4.64

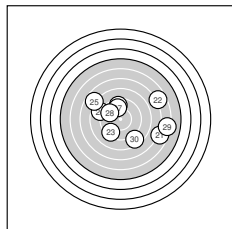

Serie 3:
 6.7 ↘ 6.7 ↗ 9.3 ✓ 8.8 ↖ 7.7 ↖
 9.5 ↑ 9.8 ↑ 9.7 ↖ 6.2 → 8.5 ↘

beste Teiler: 296.6 (27.), 317.8 (28.), 355.2 (26.)
 Trefferlage: 1.62 mm rechts, 0.50 mm hoch
 Streuwert: 5.39, horizontal: 6.64, vertikal: 3.73

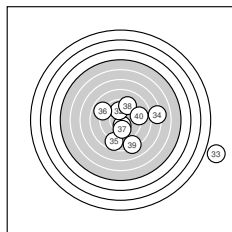

Serie 4:
 10.4 * 10.0 ↑ 0.0 → 7.2 → 8.7 ↓
 8.9 ↖ 10.0 ↓ 9.3 ↑ 8.2 ↘ 9.0 →

beste Teiler: 133.2 (31.), 234.7 (37.), 240.1 (32.)
 Trefferlage: 3.69 mm rechts, 1.28 mm tief
 Streuwert: 6.44, horizontal: 8.10, vertikal: 4.18



Ergebnis: **378.0** (359)
 Serien: 95.5 93.3 95.9 93.3
 Zähler: 9 23 6 2 0 0 0 0 0 0
 Innenzehner: 6
 Weitester: 959 (28.), 905 (34.), 686 (13.)
 beste Teiler: 70.4 (27.), 103.4 (21.), 112.9 (6.)
 Trefferlage: 0.48 mm links, 0.17 mm hoch
 Streuwert: 2.99, horizontal: 3.16, vertikal: 2.82

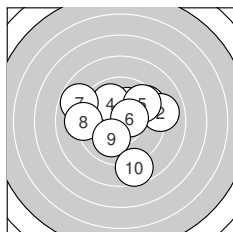
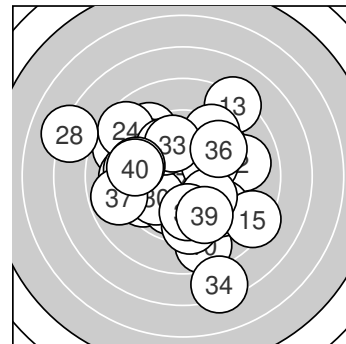

Serie 1:
 9.5 ↗ 9.0 → 10.2 * 10.0 ↘ 9.6 ↗
 10.5 * 8.8 ↖ 9.2 ← 10.0 ↙ 8.7 ↓
 beste Teiler: 112.9 (6.), 194.2 (3.), 226.0 (9.)
 Trefferlage: 0.21 mm rechts, 0.42 mm hoch
 Streuwert: 2.82, horizontal: 3.13, vertikal: 2.46

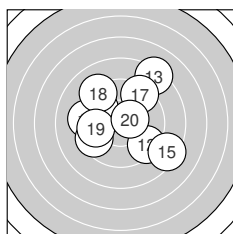

Serie 2:
 9.7 ↖ 9.4 ↘ 8.2 ↗ 9.3 ← 8.4 ↘
 9.5 ↙ 9.3 ↗ 9.2 ↘ 9.8 ← 10.5 *
 beste Teiler: 121.8 (20.), 300.6 (19.), 309.3 (11.)
 Trefferlage: 0.05 mm rechts, 0.71 mm hoch
 Streuwert: 3.22, horizontal: 3.50, vertikal: 2.91

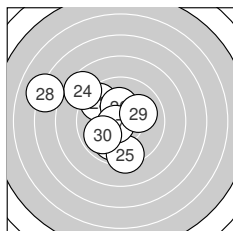

Serie 3:
 10.5 * 9.9 ↓ 9.6 ↘ 8.6 ↖ 9.4 ↓
 10.2 * 10.7 * 7.1 ↖ 10.0 → 9.9 ↙
 beste Teiler: 70.4 (27.), 103.4 (21.), 176.8 (26.)
 Trefferlage: 1.69 mm links, 0.46 mm hoch
 Streuwert: 2.85, horizontal: 3.16, vertikal: 2.50

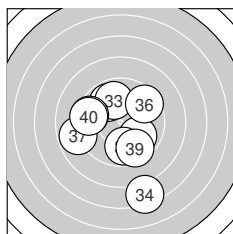

Serie 4:
 9.9 ↘ 9.8 ↖ 9.9 ↗ 7.3 ↓ 9.8 ↓
 9.5 ↗ 8.8 ← 9.4 ← 9.5 ↘ 9.4 ←
 beste Teiler: 261.9 (31.), 270.4 (33.), 276.8 (32.)
 Trefferlage: 0.49 mm links, 0.91 mm tief
 Streuwert: 3.20, horizontal: 2.93, vertikal: 3.44



Ergebnis: **390.7** (375)
 Serien: 98.0 97.2 97.5 98.0
 Zähler: 20 15 5 0 0 0 0 0 0 0
 Innenzehner: 13
 Weitester: 727 (35.), 612 (22.), 607 (28.)
 beste Teiler: 38.4 (23.), 82.1 (32.), 82.3 (24.)
 Trefferlage: 0.06 mm links, 0.66 mm hoch
 Streuwert: 2.37, horizontal: 2.43, vertikal: 2.32

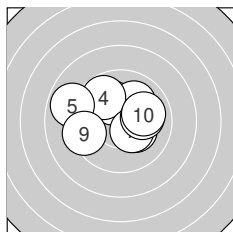
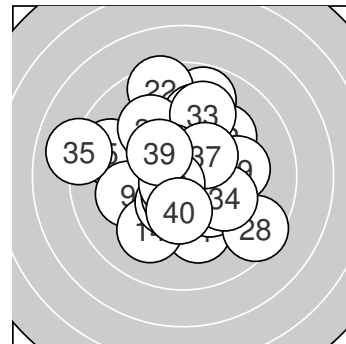

Serie 1:
 10.2 * 10.0 ↗ 9.0 ← 9.8 ↘ 8.9 ←
 10.2 * 10.4 * 10.1 → 9.4 ← 10.0 →
 beste Teiler: 149.8 (7.), 176.1 (6.), 200.0 (1.)
 Trefferlage: 0.71 mm links, 0.71 mm hoch
 Streuwert: 2.23, horizontal: 2.85, vertikal: 1.35

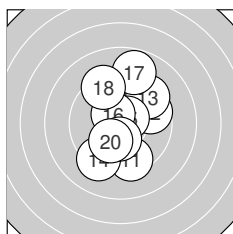

Serie 2:
 9.4 ↓ 9.6 → 9.4 ↗ 9.2 ↘ 10.6 *
 10.5 * 8.8 ↑ 9.3 ↘ 10.3 * 10.1 ↘
 beste Teiler: 85.6 (15.), 119.9 (16.), 162.3 (19.)
 Trefferlage: 0.30 mm rechts, 0.33 mm hoch
 Streuwert: 2.48, horizontal: 1.80, vertikal: 3.00

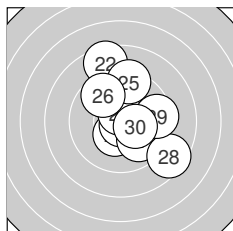

Serie 3:
 10.4 * 8.5 ↑ 10.8 * 10.6 * 9.3 ↑
 9.7 ↘ 9.9 ↘ 8.5 ↘ 9.5 → 10.3 *
 beste Teiler: 38.4 (23.), 82.3 (24.), 146.0 (21.)
 Trefferlage: 0.88 mm rechts, 0.62 mm hoch
 Streuwert: 2.54, horizontal: 2.17, vertikal: 2.86

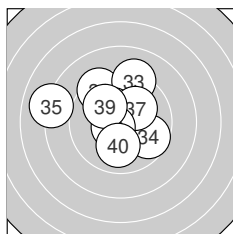

Serie 4:
 9.4 ↘ 10.6 * 9.2 ↑ 9.7 ↘ 8.0 ←
 10.4 * 10.1 ↗ 10.6 * 10.0 ↘ 10.0 ↓
 beste Teiler: 82.1 (32.), 90.9 (38.), 149.8 (36.)
 Trefferlage: 0.74 mm links, 0.97 mm hoch
 Streuwert: 2.38, horizontal: 2.70, vertikal: 2.01



Ergebnis: **374.8** (355)
 Serien: 94.1 92.3 93.8 94.6
 Zähler: 8 20 11 1 0 0 0 0 0 0
 Innenzehner: 7
 Weitester: 823 (37.), 722 (17.), 674 (30.)
 beste Teiler: 53.2 (16.), 71.5 (24.), 140.6 (35.)
 Trefferlage: 0.56 mm links, 0.97 mm hoch
 Streuwert: 2.98, horizontal: 3.24, vertikal: 2.70

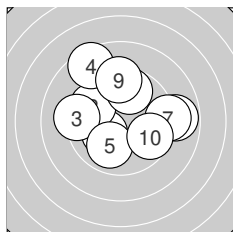
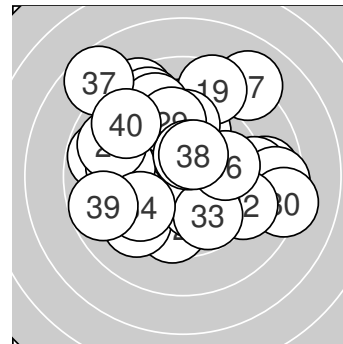

Serie 1:

10.2 *	9.7 ↘	9.2 ←	8.5 ↖	9.9 ↙
8.8 →	9.1 →	9.7 ↑	9.3 ↑	9.7 ↘

beste Teiler: 194.0 (1.), 253.7 (5.), 304.4 (8.)
 Trefferlage: 0.10 mm rechts, 0.99 mm hoch
 Streuwert: 2.90, horizontal: 3.26, vertikal: 2.48

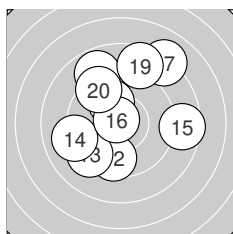

Serie 2:

10.1 ↖	9.6 ↓	9.3 ↙	9.1 ←	8.6 →
10.7 *	8.1 ↗	8.8 ↖	8.6 ↑	9.4 ↖

beste Teiler: 53.2 (16.), 220.6 (11.), 344.9 (12.)
 Trefferlage: 0.17 mm links, 1.37 mm hoch
 Streuwert: 3.37, horizontal: 3.28, vertikal: 3.46

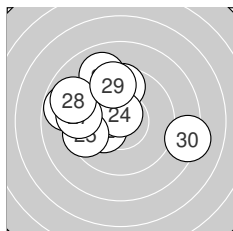

Serie 3:

9.6 ↑	10.2 *	8.8 ←	10.7 *	9.5 ←
9.0 ↖	9.3 ←	8.9 ↖	9.5 ↑	8.3 →

beste Teiler: 71.5 (24.), 181.5 (22.), 336.3 (21.)
 Trefferlage: 1.48 mm links, 1.21 mm hoch
 Streuwert: 2.83, horizontal: 3.39, vertikal: 2.12

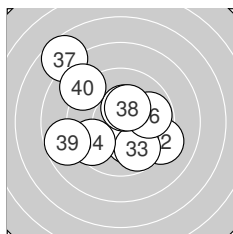

Serie 4:

10.2 *	9.2 ↘	9.8 ↘	9.6 ↙	10.4 *
9.8 →	7.7 ↖	10.3 *	8.7 ←	8.9 ↖

beste Teiler: 140.6 (35.), 154.7 (38.), 198.0 (31.)
 Trefferlage: 0.70 mm links, 0.29 mm hoch
 Streuwert: 3.10, horizontal: 3.32, vertikal: 2.86



Ergebnis: **386.5** (369)
 Serien: 97.5 95.6 93.8 99.6
 Zähler: 16 18 5 1 0 0 0 0 0 0
 Innenzehner: 9
 Weitester: 818 (1.), 654 (26.), 569 (21.)
 beste Teiler: 37.4 (39.), 49.3 (34.), 79.6 (28.)
 Trefferlage: 0.89 mm rechts, 0.15 mm tief
 Streuwert: 2.53, horizontal: 2.93, vertikal: 2.07

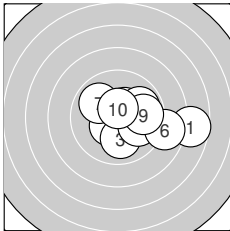
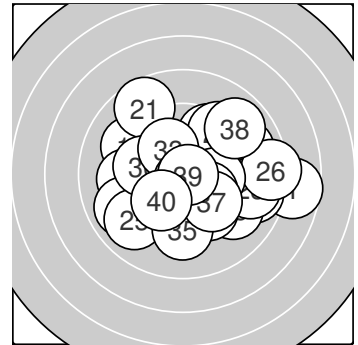

Serie 1:
 7.7 → 10.4 * 10.0 ↓ 10.4 * 10.0 →
 8.8 → 9.9 ↘ 9.9 ↗ 9.8 → 10.6 *
 beste Teiler: 98.0 (10.), 130.1 (2.), 132.4 (4.)
 Trefferlage: 1.91 mm rechts, 0.16 mm tief
 Streuwert: 2.33, horizontal: 3.02, vertikal: 1.34

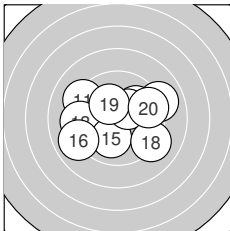

Serie 2:
 9.2 ↘ 10.0 ↗ 9.3 ← 9.0 → 10.0 ↓
 9.0 ← 10.3 * 9.1 ↘ 10.2 * 9.5 →
 beste Teiler: 151.6 (17.), 181.6 (19.), 227.0 (15.)
 Trefferlage: 0.08 mm rechts, 0.14 mm hoch
 Streuwert: 2.74, horizontal: 3.40, vertikal: 1.87

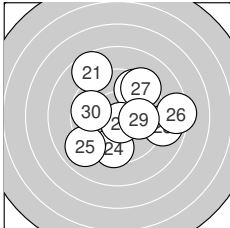

Serie 3:
 8.7 ↘ 9.6 ↗ 8.9 → 9.6 ↓ 9.0 ↗
 8.3 → 9.3 ↗ 10.6 * 10.0 → 9.8 ←
 beste Teiler: 79.6 (28.), 238.8 (29.), 299.8 (30.)
 Trefferlage: 0.88 mm rechts, 0.30 mm hoch
 Streuwert: 3.10, horizontal: 3.43, vertikal: 2.74

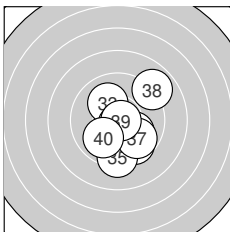

Serie 4:
 10.3 * 9.6 ↘ 10.1 ↘ 10.8 * 9.3 ↓
 10.1 ↘ 9.8 ↘ 8.9 ↗ 10.8 * 9.9 ↗
 beste Teiler: 37.4 (39.), 49.3 (34.), 155.3 (31.)
 Trefferlage: 0.71 mm rechts, 0.88 mm tief
 Streuwert: 1.95, horizontal: 1.67, vertikal: 2.20



Ergebnis: **398.4** (380)
 Serien: 97.1 99.7 100.6 101.0
 Zähler: 22 16 2 0 0 0 0 0 0 0
 Innenzehner: 16
 Weitester: 664 (5.), 545 (2.), 453 (22.)
 beste Teiler: 46.1 (33.), 47.6 (18.), 48.0 (29.)
 Trefferlage: 0.96 mm rechts, 0.81 mm hoch
 Streuwert: 1.83, horizontal: 1.85, vertikal: 1.81

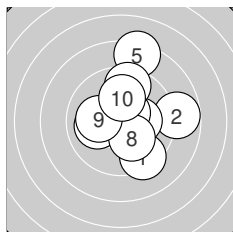
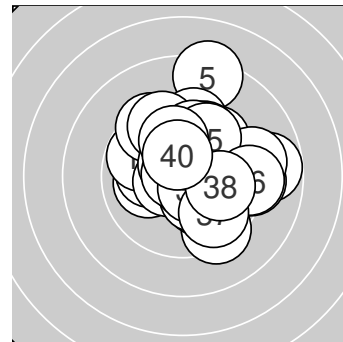

Serie 1:
 9.3 ↘ 8.8 → 10.2 * 10.5 * 8.3 ↗
 9.6 ↑ 10.0 ← 10.2 * 10.1 ← 10.1 ↑
 beste Teiler: 102.6 (4.), 177.1 (3.), 193.6 (8.)
 Trefferlage: 0.91 mm rechts, 0.83 mm hoch
 Streuwert: 2.47, horizontal: 2.18, vertikal: 2.72

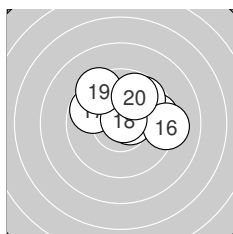

Serie 2:
 9.6 → 10.7 * 10.0 ↗ 10.6 * 9.7 ↗
 9.2 → 9.8 ↖ 10.8 * 9.5 ↘ 9.8 ↗
 beste Teiler: 47.6 (18.), 73.8 (12.), 92.3 (14.)
 Trefferlage: 0.90 mm rechts, 1.28 mm hoch
 Streuwert: 1.74, horizontal: 2.16, vertikal: 1.17

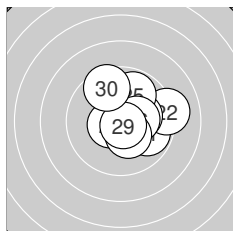

Serie 3:
 9.8 ↘ 9.1 → 10.2 * 10.2 * 9.8 ↗
 10.3 * 10.5 * 10.3 * 10.8 * 9.6 ↘
 beste Teiler: 48.0 (29.), 103.7 (27.), 153.0 (28.)
 Trefferlage: 1.10 mm rechts, 0.59 mm hoch
 Streuwert: 1.60, horizontal: 1.67, vertikal: 1.52

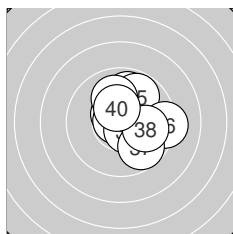

Serie 4:
 9.9 ↑ 10.6 * 10.8 * 10.6 * 9.8 ↗
 9.2 → 9.7 ↘ 10.0 → 10.0 ↑ 10.4 *
 beste Teiler: 46.1 (33.), 99.6 (34.), 100.7 (32.)
 Trefferlage: 0.93 mm rechts, 0.56 mm hoch
 Streuwert: 1.62, horizontal: 1.61, vertikal: 1.63



Ergebnis: **387.6** (369)
 Serien: 99.0 100.5 93.2 94.9
 Zähler: 17 17 4 2 0 0 0 0 0 0
 Innenzehner: 14
 Weitester: 840 (38.), 775 (21.), 592 (32.)
 beste Teiler: 48.0 (4.), 58.0 (11.), 66.9 (20.)
 Trefferlage: 0.45 mm links, 1.05 mm hoch
 Streuwert: 2.52, horizontal: 3.11, vertikal: 1.74

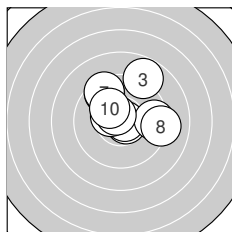
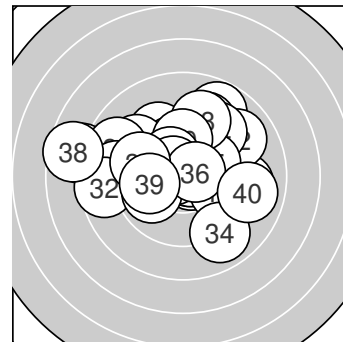

Serie 1:
 10.7 * 9.5 ↘ 8.8 ↗ 10.8 * 10.5 *
 9.4 → 9.4 ↘ 9.1 → 10.6 * 10.2 *
 beste Teiler: 48.0 (4.), 67.5 (1.), 85.8 (9.)
 Trefferlage: 0.53 mm rechts, 1.31 mm hoch
 Streuwert: 2.08, horizontal: 2.32, vertikal: 1.80

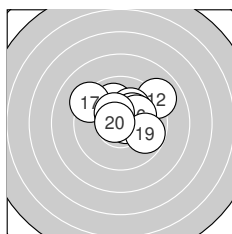

Serie 2:
 10.7 * 9.0 ↗ 10.0 ↘ 10.1 ↗ 10.3 *
 10.2 * 9.3 ↖ 10.4 * 9.8 ↘ 10.7 *
 beste Teiler: 58.0 (11.), 66.9 (20.), 136.0 (18.)
 Trefferlage: 0.58 mm rechts, 1.12 mm hoch
 Streuwert: 1.72, horizontal: 2.11, vertikal: 1.21

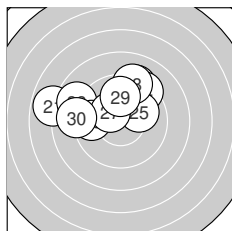

Serie 3:
 7.9 ← 9.2 ↗ 8.8 ↖ 9.3 ↗ 10.0 ↗
 9.7 ← 10.3 * 9.2 ↗ 9.8 ↑ 9.0 ←
 beste Teiler: 153.1 (27.), 229.8 (25.), 277.0 (29.)
 Trefferlage: 1.42 mm links, 2.06 mm hoch
 Streuwert: 2.71, horizontal: 3.54, vertikal: 1.46

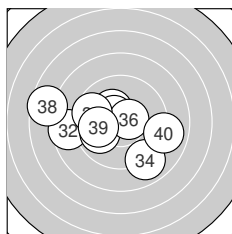

Serie 4:
 10.3 * 8.6 ← 10.5 * 8.9 ↘ 9.9 ←
 10.6 * 9.6 ← 7.6 ← 9.9 ← 9.0 →
 beste Teiler: 97.0 (36.), 103.9 (33.), 171.1 (31.)
 Trefferlage: 1.52 mm links, 0.27 mm tief
 Streuwert: 3.00, horizontal: 3.85, vertikal: 1.77



Ergebnis: **387.9** (368)
 Serien: 97.1 96.7 98.6 95.5
 Zähler: 15 19 5 1 0 0 0 0 0 0
 Innenzehner: 11
 Weitester: 907 (19.), 651 (5.), 560 (8.)
 beste Teiler: 49.6 (35.), 78.3 (4.), 125.8 (15.)
 Trefferlage: 0.00 mm , 0.47 mm hoch
 Streuwert: 2.52, horizontal: 2.73, vertikal: 2.29

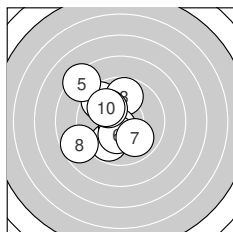
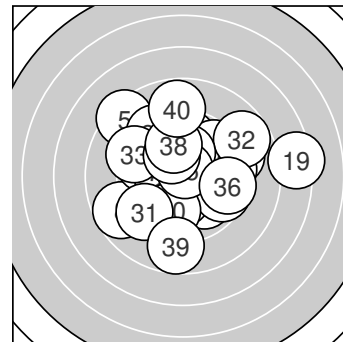

Serie 1:
 9.6 ↘ 9.8 ↙ 9.8 ↑ 10.6 * 8.3 ↘
 10.3 * 9.9 ↘ 8.7 ↙ 10.1 ↘ 10.0 ↘
 beste Teiler: 78.3 (4.), 165.9 (6.), 206.4 (9.)
 Trefferlage: 1.52 mm links, 0.36 mm hoch
 Streuwert: 2.34, horizontal: 2.08, vertikal: 2.57

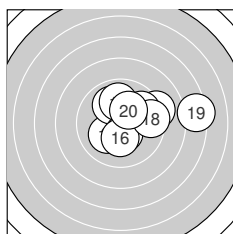

Serie 2:
 10.1 ↙ 10.0 ↘ 9.1 → 9.8 ↗ 10.5 *
 10.3 * 9.9 ↑ 9.5 → 7.3 → 10.2 *
 beste Teiler: 125.8 (15.), 173.1 (16.), 181.2 (20.)
 Trefferlage: 1.75 mm rechts, 0.69 mm hoch
 Streuwert: 2.51, horizontal: 3.19, vertikal: 1.55

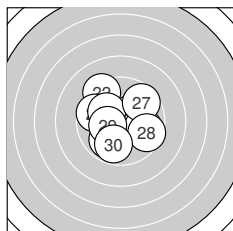

Serie 3:
 10.4 * 9.3 ↘ 9.7 ← 10.2 * 9.9 ↙
 9.8 → 9.6 ↗ 9.6 → 10.3 * 9.8 ↙
 beste Teiler: 133.2 (21.), 161.9 (29.), 200.2 (24.)
 Trefferlage: 0.15 mm links, 0.09 mm hoch
 Streuwert: 2.11, horizontal: 2.26, vertikal: 1.94

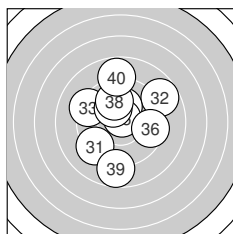

Serie 4:
 9.3 ↙ 8.8 ↗ 9.3 ↘ 10.2 * 10.8 *
 9.5 → 10.2 * 9.9 ↑ 8.7 ↓ 8.8 ↑
 beste Teiler: 49.6 (35.), 186.7 (34.), 187.4 (37.)
 Trefferlage: 0.08 mm links, 0.73 mm hoch
 Streuwert: 2.86, horizontal: 2.59, vertikal: 3.10



Ergebnis: **404.1** (385)
Serien: 102.9 100.5 102.7 98.0
Zähler: 26 13 1 0 0 0 0 0 0 0
Innenzehner: 22
Weiteste: 538 (36.), 414 (11.), 405 (35.)
beste Teiler: 26.8 (37.), 28.0 (23.), 58.2 (3.)
Trefferlage: 0.16 mm rechts, 0.34 mm tief
Streuwert: 1.70, horizontal: 1.95, vertikal: 1.41

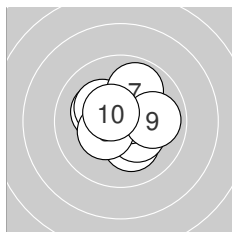
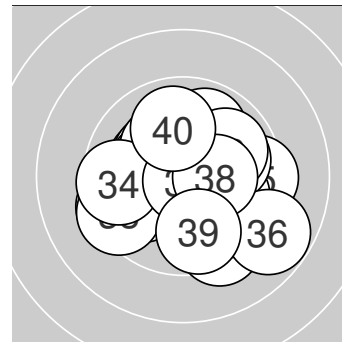

Serie 1:
 10.2 * 10.2 * 10.7 * 10.3 * 10.2 *
 10.6 * 9.9 ↗ 10.4 * 9.9 → 10.5 *
beste Teiler: 58.2 (3.), 87.6 (6.), 102.6 (10.)
Trefferlage: 0.10 mm rechts, 0.15 mm hoch
Streuwert: 1.30, horizontal: 1.41, vertikal: 1.19

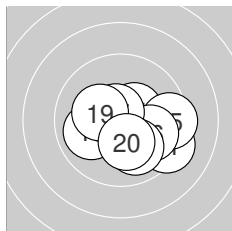

Serie 2:
 9.3 ↘ 10.3 * 10.0 ← 10.4 * 9.4 →
 9.9 ↘ 10.7 * 10.0 ↘ 10.3 * 10.2 *
beste Teiler: 73.9 (17.), 131.1 (14.), 161.1 (12.)
Trefferlage: 0.88 mm rechts, 0.72 mm tief
Streuwert: 1.64, horizontal: 2.03, vertikal: 1.12

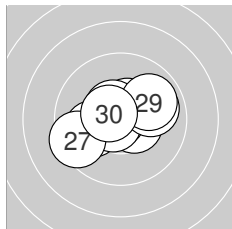

Serie 3:
 10.5 * 10.5 * 10.8 * 10.5 * 10.0 ←
 10.7 * 9.4 ← 9.9 → 9.9 → 10.5 *
beste Teiler: 28.0 (23.), 69.4 (26.), 102.4 (30.)
Trefferlage: 0.17 mm links, 0.13 mm hoch
Streuwert: 1.45, horizontal: 1.83, vertikal: 0.93

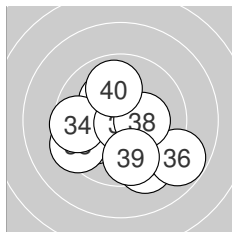

Serie 4:
 10.2 * 10.0 ← 9.4 ← 9.6 ← 9.3 ↘
 8.8 ↘ 10.8 * 10.3 * 9.7 ↘ 9.9 ↑
beste Teiler: 26.8 (37.), 170.0 (38.), 185.4 (31.)
Trefferlage: 0.14 mm links, 0.92 mm tief
Streuwert: 2.26, horizontal: 2.50, vertikal: 1.99



Ergebnis: **402.4** (383)
 Serien: 97.0 103.6 100.6 101.2
 Zähler: 24 15 1 0 0 0 0 0 0
 Innenzehner: 19
 Weitestе: 508 (6.), 488 (4.), 434 (3.)
 beste Teiler: 20.0 (34.), 51.4 (13.), 63.6 (39.)
 Trefferlage: 0.10 mm rechts, 0.64 mm hoch
 Streuwert: 1.76, horizontal: 2.13, vertikal: 1.29

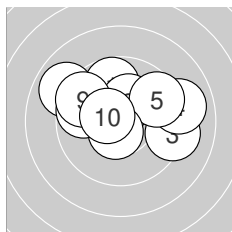
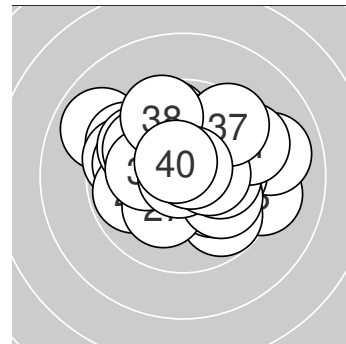

Serie 1:
 9.7 ↑ 10.3 * 9.2 → 9.0 → 9.6 ↗
 8.9 ↘ 10.6 * 9.7 ← 9.5 ↘ 10.5 *
 beste Teiler: 94.3 (7.), 117.1 (10.), 173.6 (2.)
 Trefferlage: 0.00 mm , 1.13 mm hoch
 Streuwert: 2.41, horizontal: 3.15, vertikal: 1.30

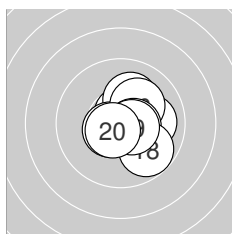

Serie 2:
 10.0 → 10.6 * 10.7 * 10.1 ↗ 10.5 *
 10.2 * 10.5 * 9.8 ↘ 10.6 * 10.6 *
 beste Teiler: 51.4 (13.), 76.6 (12.), 86.3 (20.)
 Trefferlage: 0.75 mm rechts, 0.07 mm hoch
 Streuwert: 1.09, horizontal: 1.04, vertikal: 1.13

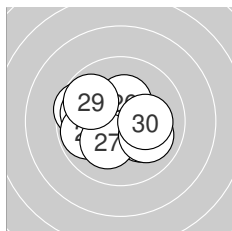

Serie 3:
 10.7 * 9.6 ← 9.9 ← 9.8 ← 10.2 *
 10.3 * 10.2 * 10.0 ↘ 9.8 ↘ 10.1 →
 beste Teiler: 74.0 (21.), 155.7 (26.), 194.4 (27.)
 Trefferlage: 0.53 mm links, 0.04 mm hoch
 Streuwert: 1.70, horizontal: 2.11, vertikal: 1.16

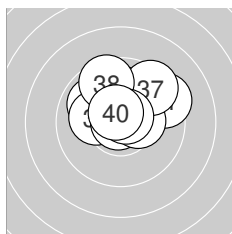

Serie 4:
 9.4 ↗ 9.9 ↘ 10.2 * 10.9 * 10.0 ↑
 10.4 * 9.5 ↗ 9.6 ↑ 10.7 * 10.6 *
 beste Teiler: 20.0 (34.), 63.6 (39.), 87.2 (40.)
 Trefferlage: 0.21 mm rechts, 1.32 mm hoch
 Streuwert: 1.53, horizontal: 1.83, vertikal: 1.16



Ergebnis: **357.8** (341)
 Serien: 92.2 85.9 88.4 91.3
 Zähler: 7 16 9 7 1 0 0 0 0 0
 Innenzehner: 5
 Weitester: 1068 (30.), 961 (13.), 952 (3.)
 beste Teiler: 57.8 (35.), 101.1 (27.), 118.0 (7.)
 Trefferlage: 0.24 mm rechts, 0.71 mm hoch
 Streuwert: 4.00, horizontal: 4.65, vertikal: 3.22

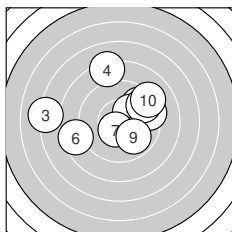
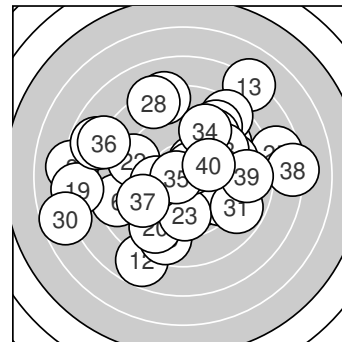

Serie 1:
 9.4 → 9.7 ↗ 7.1 ← 8.2 ↑ 10.2 *
 8.6 ← 10.5 * 9.5 ↗ 9.9 ↘ 9.1 ↗
 beste Teiler: 118.0 (7.), 179.8 (5.), 264.6 (9.)
 Trefferlage: 0.11 mm links, 1.16 mm hoch
 Streuwert: 3.59, horizontal: 4.38, vertikal: 2.58

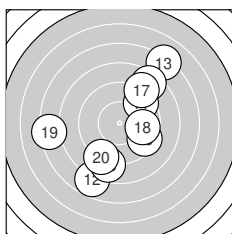

Serie 2:
 9.5 ↗ 7.8 ↓ 7.1 ↗ 8.4 ↗ 9.4 ↘
 8.7 ↓ 8.9 ↗ 9.8 → 7.3 ← 9.0 ↓
 beste Teiler: 299.3 (18.), 375.6 (11.), 376.3 (15.)
 Trefferlage: 0.46 mm rechts, 0.07 mm tief
 Streuwert: 4.69, horizontal: 4.47, vertikal: 4.89

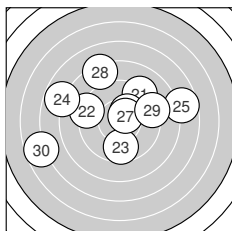

Serie 3:
 9.2 ↗ 9.2 ← 9.6 ↓ 7.8 ← 7.7 →
 10.3 * 10.5 * 8.2 ↑ 9.2 → 6.7 ←
 beste Teiler: 101.1 (27.), 158.8 (26.), 328.3 (23.)
 Trefferlage: 0.75 mm links, 1.25 mm hoch
 Streuwert: 4.36, horizontal: 5.41, vertikal: 2.96

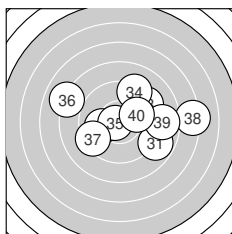

Serie 4:
 8.8 ↘ 10.0 ← 9.3 ↗ 9.2 ↑ 10.7 *
 8.0 ← 9.3 ← 7.2 → 8.8 → 10.0 →
 beste Teiler: 57.8 (35.), 234.0 (32.), 239.6 (40.)
 Trefferlage: 1.38 mm rechts, 0.52 mm hoch
 Streuwert: 3.67, horizontal: 4.75, vertikal: 2.08



Ergebnis: **374.0** (358)
Serien: 94.9 92.3 92.1 94.7
Zähler: 11 16 13 0 0 0 0 0 0 0
Innenzehner: 9
Weiteste: 723 (12.), 704 (23.), 702 (38.)
beste Teiler: 76.6 (2.), 107.8 (29.), 139.4 (15.)
Trefferlage: 0.05 mm rechts, 1.31 mm hoch
Streuwert: 3.03, horizontal: 3.51, vertikal: 2.46

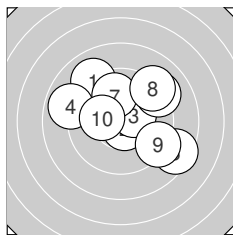
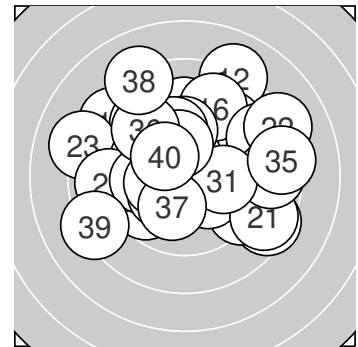

Serie 1:
 9.0 ↘ 10.6 * 10.4 * 8.9 ↖ 9.1 ↗
 8.5 ↘ 9.9 ↑ 9.1 ↗ 9.2 ↘ 10.2 *
beste Teiler: 76.6 (2.), 144.8 (3.), 187.1 (10.)
Trefferlage: 0.76 mm rechts, 0.89 mm hoch
Streuwert: 2.87, horizontal: 3.31, vertikal: 2.35

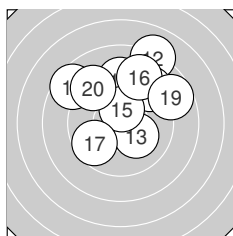

Serie 2:
 9.2 ↑ 8.1 ↗ 10.2 * 9.2 ↗ 10.4 *
 9.0 ↗ 9.7 ↖ 8.6 ↖ 8.7 ↗ 9.2 ↘
beste Teiler: 139.4 (15.), 196.4 (13.), 324.8 (17.)
Trefferlage: 0.44 mm rechts, 2.66 mm hoch
Streuwert: 2.84, horizontal: 3.06, vertikal: 2.60

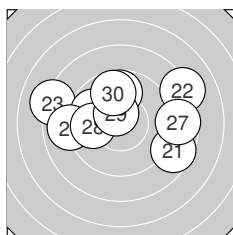

Serie 3:
 8.6 ↘ 8.2 ↗ 8.1 ↖ 9.7 ↑ 9.8 ↖
 8.9 ↖ 8.7 → 9.9 ↖ 10.5 * 9.7 ↑
beste Teiler: 107.8 (29.), 274.2 (28.), 294.9 (25.)
Trefferlage: 0.14 mm links, 1.02 mm hoch
Streuwert: 3.46, horizontal: 4.51, vertikal: 1.89

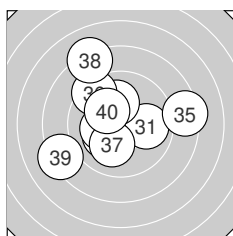

Serie 4:
 9.9 → 10.1 ↑ 10.2 * 10.2 * 8.4 →
 9.3 ↘ 10.1 ↓ 8.1 ↘ 8.2 ↖ 10.2 *
beste Teiler: 184.8 (34.), 187.3 (40.), 195.4 (33.)
Trefferlage: 0.86 mm links, 0.68 mm hoch
Streuwert: 3.06, horizontal: 3.33, vertikal: 2.76



Ergebnis: **367.2** (346)
 Serien: 93.0 94.2 90.9 89.1
 Zähler: 4 20 14 2 0 0 0 0 0 0
 Innenzehner: 3
 Weitester: 809 (33.), 779 (36.), 721 (9.)
 beste Teiler: 113.0 (38.), 133.4 (26.), 149.8 (37.)
 Trefferlage: 0.47 mm links, 1.28 mm hoch
 Streuwert: 3.29, horizontal: 3.70, vertikal: 2.83

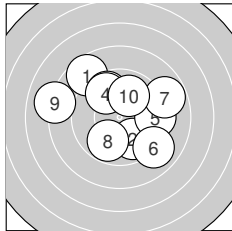
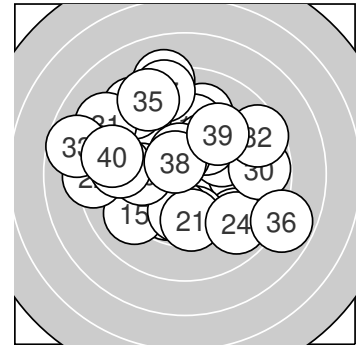

Serie 1:

8.6 ↘	9.9 ↘	9.7 ↗	9.8 ↗	9.4 →
9.0 ↘	8.8 ↗	9.8 ↘	8.1 ←	9.9 ↗

beste Teiler: 253.5 (10.), 275.9 (2.), 284.4 (8.)
 Trefferlage: 0.02 mm rechts, 0.78 mm hoch
 Streuwert: 3.23, horizontal: 3.71, vertikal: 2.68

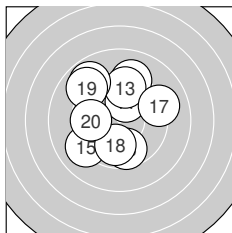

Serie 2:

10.1 ↗	9.2 ↗	9.5 ↗	8.9 ↘	9.1 ↗
9.7 ↘	9.1 ↗	9.9 ↘	9.0 ↘	9.7 ←

beste Teiler: 213.7 (11.), 271.9 (18.), 312.0 (20.)
 Trefferlage: 0.65 mm links, 1.04 mm hoch
 Streuwert: 2.84, horizontal: 2.66, vertikal: 3.00

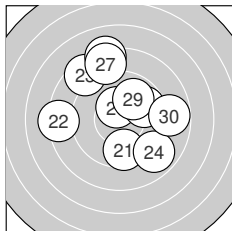

Serie 3:

9.6 ↓	8.3 ←	8.5 ↘	8.9 ↘	8.2 ↗
10.4 *	8.5 ↗	9.8 ↗	9.9 ↗	8.8 →

beste Teiler: 133.4 (26.), 264.0 (29.), 299.6 (28.)
 Trefferlage: 0.00 mm, 1.57 mm hoch
 Streuwert: 3.56, horizontal: 3.59, vertikal: 3.54

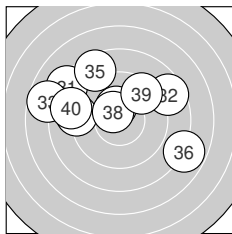

Serie 4:

8.2 ↘	8.6 ↗	7.7 ←	9.1 ←	8.5 ↘
7.8 ↘	10.4 *	10.5 *	9.5 ↗	8.8 ←

beste Teiler: 113.0 (38.), 149.8 (37.), 375.7 (39.)
 Trefferlage: 1.26 mm links, 1.74 mm hoch
 Streuwert: 3.85, horizontal: 4.93, vertikal: 2.32



Ergebnis: **345.9** (327)
 Serien: 86.1 86.0 86.0 87.8
 Zähler: 5 14 8 9 4 0 0 0 0 0
 Innenzehner: 3
 Weitester: 1217 (34.), 1130 (28.), 1034 (4.)
 beste Teiler: 107.0 (36.), 179.7 (33.), 197.7 (14.)
 Trefferlage: 0.63 mm rechts, 1.75 mm tief
 Streuwert: 4.40, horizontal: 4.96, vertikal: 3.76

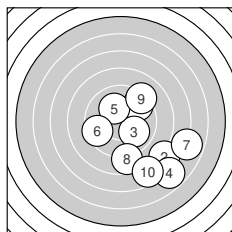
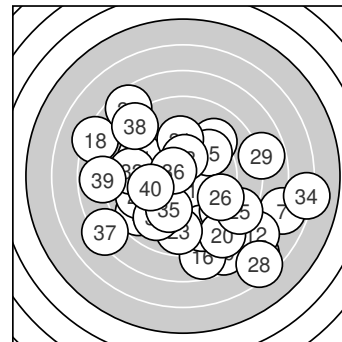

Serie 1:
 9.6 ↗ 7.7 ↘ 10.0 ↘ 6.8 ↘ 10.1 ↘
 9.5 ← 6.9 → 8.7 ↓ 9.2 ↗ 7.6 ↘
 beste Teiler: 206.1 (5.), 248.2 (3.), 335.4 (1.)
 Trefferlage: 3.11 mm rechts, 2.43 mm tief
 Streuwert: 3.93, horizontal: 3.87, vertikal: 3.99

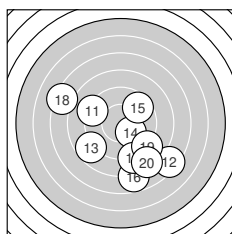

Serie 2:
 9.2 ↖ 7.3 ↘ 8.7 ↗ 10.2 * 9.6 ↗
 7.8 ↓ 8.8 ↓ 7.3 ↖ 8.9 ↘ 8.2 ↘
 beste Teiler: 197.7 (14.), 339.8 (15.), 448.0 (11.)
 Trefferlage: 0.56 mm rechts, 2.46 mm tief
 Streuwert: 4.32, horizontal: 4.72, vertikal: 3.87

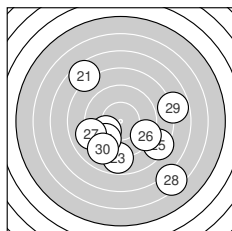

Serie 3:
 7.6 ↖ 9.9 ↗ 8.8 ↓ 9.6 ↗ 8.4 ↘
 9.3 ↘ 9.1 ← 6.4 ↘ 7.8 → 9.1 ↗
 beste Teiler: 259.3 (22.), 337.8 (24.), 420.3 (26.)
 Trefferlage: 0.73 mm rechts, 2.06 mm tief
 Streuwert: 4.50, horizontal: 4.88, vertikal: 4.08

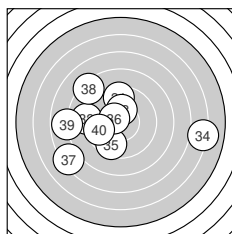

Serie 4:
 9.5 ↑ 9.0 ← 10.2 * 6.1 → 9.6 ↘
 10.5 * 7.2 ↗ 8.3 ↖ 7.8 ← 9.6 ←
 beste Teiler: 107.0 (36.), 179.7 (33.), 332.7 (40.)
 Trefferlage: 1.85 mm links, 0.07 mm tief
 Streuwert: 4.55, horizontal: 5.65, vertikal: 3.07



Ergebnis: **393.4** (374)
Serien: 101.4 99.1 94.3 98.6
Zähler: 19 17 3 1 0 0 0 0 0 0
Innenzehner: 12
Weiteste: 805 (23.), 689 (22.), 594 (31.)
beste Teiler: 44.4 (5.), 58.6 (20.), 74.9 (21.)
Trefferlage: 0.23 mm rechts, 0.77 mm hoch
Streuwert: 2.25, horizontal: 2.70, vertikal: 1.67

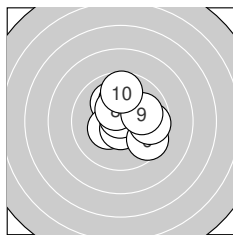
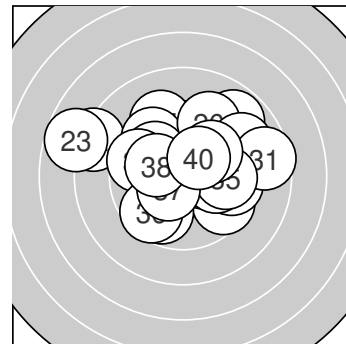

Serie 1:
 10.1 ↘ 10.1 ↑ 10.4 * 10.6 * 10.8 *
 9.6 ↘ 9.7 → 10.4 * 10.0 → 9.7 ↑
beste Teiler: 44.4 (5.), 79.0 (4.), 136.4 (8.)
Trefferlage: 0.54 mm rechts, 0.60 mm hoch
Streuwert: 1.59, horizontal: 1.61, vertikal: 1.56

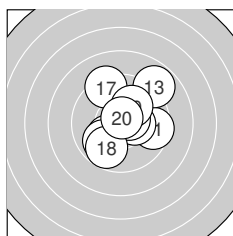

Serie 2:
 9.5 → 10.2 * 8.8 ↗ 10.3 * 9.9 ↙
 10.5 * 9.3 ↘ 9.8 ↙ 10.1 ↗ 10.7 *
beste Teiler: 58.6 (20.), 102.0 (16.), 151.3 (14.)
Trefferlage: 0.45 mm rechts, 0.40 mm hoch
Streuwert: 2.13, horizontal: 2.04, vertikal: 2.23

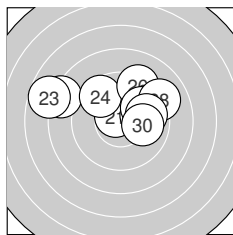

Serie 3:
 10.7 * 8.2 ↖ 7.7 ↖ 9.6 ↘ 10.0 →
 9.3 ↗ 9.9 ↗ 9.1 ↗ 9.8 → 10.0 →
beste Teiler: 74.9 (21.), 226.9 (25.), 239.2 (30.)
Trefferlage: 0.11 mm links, 1.67 mm hoch
Streuwert: 3.01, horizontal: 4.05, vertikal: 1.30

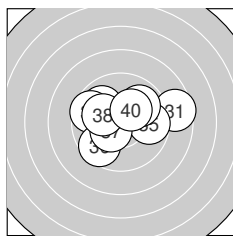

Serie 4:
 8.6 → 9.9 ↘ 10.5 * 9.6 ↖ 9.7 →
 9.6 ↙ 10.4 * 10.1 ↖ 9.9 ↗ 10.3 *
beste Teiler: 105.2 (33.), 139.4 (37.), 171.5 (40.)
Trefferlage: 0.06 mm rechts, 0.41 mm hoch
Streuwert: 2.23, horizontal: 2.85, vertikal: 1.35



Ergebnis: **391.4** (371)
 Serien: 96.3 97.9 98.6 98.6
 Zähler: 17 17 6 0 0 0 0 0 0 0
 Innenzehner: 10
 Weitester: 638 (4.), 607 (23.), 580 (39.)
 beste Teiler: 89.0 (38.), 94.4 (20.), 108.4 (24.)
 Trefferlage: 1.05 mm rechts, 0.33 mm tief
 Streuwert: 2.16, horizontal: 2.54, vertikal: 1.71

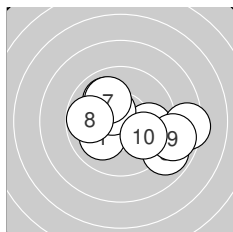
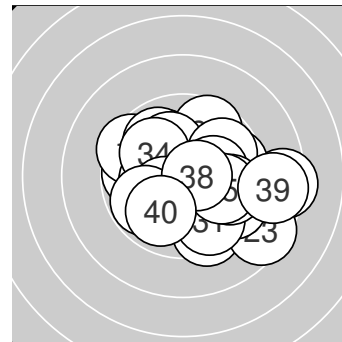

Serie 1:
 10.0 ↙ 9.9 → 10.0 ↘ 8.4 → 8.9 ↘
 10.5 * 10.0 ↘ 9.8 ← 8.9 → 9.9 ↘
 beste Teiler: 120.5 (6.), 226.3 (1.), 235.9 (7.)
 Trefferlage: 1.25 mm rechts, 0.31 mm tief
 Streuwert: 2.58, horizontal: 3.27, vertikal: 1.60

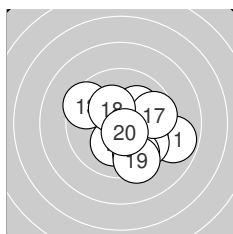

Serie 2:
 8.8 → 10.2 * 9.5 ↘ 9.7 ↘ 10.1 ↗
 9.7 ↘ 9.6 → 10.3 * 9.4 ↘ 10.6 *
 beste Teiler: 94.4 (20.), 163.2 (18.), 196.4 (12.)
 Trefferlage: 1.07 mm rechts, 0.72 mm tief
 Streuwert: 2.12, horizontal: 2.32, vertikal: 1.90

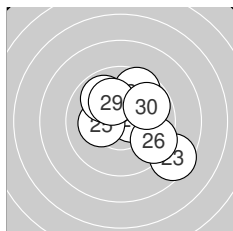

Serie 3:
 10.1 ↗ 10.4 * 8.5 ↘ 10.5 * 10.2 *
 9.5 ↘ 9.6 ↗ 9.9 ↘ 10.1 ↘ 9.8 ↗
 beste Teiler: 108.4 (24.), 146.4 (22.), 185.1 (25.)
 Trefferlage: 1.00 mm rechts, 0.52 mm hoch
 Streuwert: 2.09, horizontal: 2.25, vertikal: 1.92

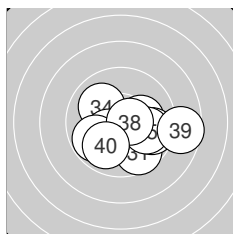

Serie 4:
 9.6 ↘ 10.2 * 9.7 → 10.0 ↘ 9.9 →
 10.3 * 9.8 ↙ 10.6 * 8.6 → 9.9 ↙
 beste Teiler: 89.0 (38.), 154.6 (36.), 195.8 (32.)
 Trefferlage: 0.89 mm rechts, 0.81 mm tief
 Streuwert: 2.03, horizontal: 2.59, vertikal: 1.24



Ergebnis: **397.4** (377)
 Serien: 101.5 96.6 99.9 99.4
 Zähler: 18 21 1 0 0 0 0 0 0
 Innenzehner: 14
 Weitestе: 531 (13.), 426 (20.), 401 (12.)
 beste Teiler: 63.1 (5.), 81.0 (25.), 88.5 (4.)
 Trefferlage: 0.03 mm links, 0.45 mm hoch
 Streuwert: 1.93, horizontal: 2.22, vertikal: 1.57

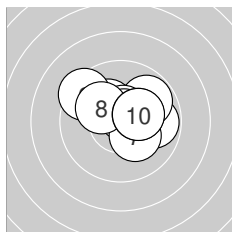
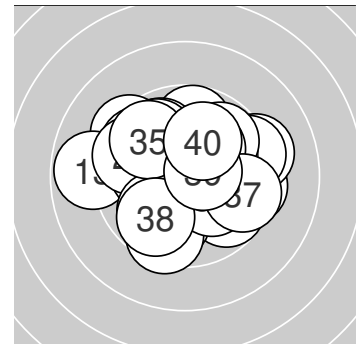

Serie 1:

9.8 →	10.3 *	9.8 ↗	10.6 *	10.7 *
9.4 ↘	10.2 *	10.1 ↘	10.3 *	10.3 *

beste Teiler: 63.1 (5.), 88.5 (4.), 163.0 (9.)
 Trefferlage: 0.40 mm rechts, 0.78 mm hoch
 Streuwert: 1.49, horizontal: 1.86, vertikal: 0.98

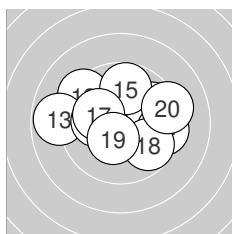

Serie 2:

9.8 ↗	9.3 ↘	8.8 ←	9.5 →	9.7 ↑
10.1 ←	10.1 ←	9.7 ↘	10.4 *	9.2 →

beste Teiler: 146.6 (19.), 203.9 (17.), 205.7 (16.)
 Trefferlage: 0.01 mm rechts, 0.56 mm hoch
 Streuwert: 2.48, horizontal: 3.15, vertikal: 1.54

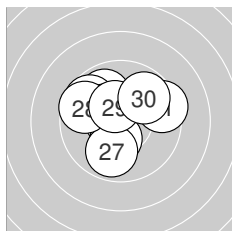

Serie 3:

9.4 →	9.9 ↘	9.7 ↘	10.3 *	10.6 *
10.3 *	9.9 ↓	9.6 ↘	10.4 *	9.8 ↗

beste Teiler: 81.0 (25.), 135.5 (29.), 155.9 (26.)
 Trefferlage: 0.54 mm links, 0.65 mm hoch
 Streuwert: 1.80, horizontal: 2.00, vertikal: 1.57

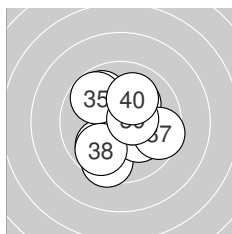

Serie 4:

9.9 ↘	9.9 ↙	10.2 *	9.5 ↓	9.8 ↘
10.2 *	9.6 →	9.8 ↙	10.5 *	10.0 ↗

beste Teiler: 107.7 (39.), 198.0 (36.), 200.0 (33.)
 Trefferlage: 0.00 mm , 0.17 mm tief
 Streuwert: 1.97, horizontal: 1.86, vertikal: 2.08



Ergebnis: **375.6** (358)
 Serien: 94.0 95.2 95.0 91.4
 Zähler: 13 15 10 1 1 0 0 0 0 0
 Innenzehner: 7
 Weitester: 1061 (36.), 796 (2.), 736 (26.)
 beste Teiler: 61.1 (24.), 67.1 (29.), 97.1 (9.)
 Trefferlage: 1.41 mm rechts, 0.21 mm tief
 Streuwert: 3.00, horizontal: 3.46, vertikal: 2.46

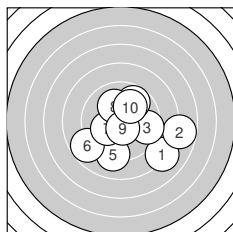
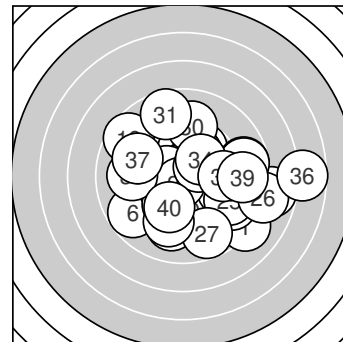

Serie 1:
 8.1 ↘ 7.8 → 9.5 → 9.7 ↗ 9.2 ↓
 8.8 ↙ 10.2 * 10.1 ↖ 10.6 * 10.0 ↗
 beste Teiler: 97.1 (9.), 200.9 (7.), 218.7 (8.)
 Trefferlage: 1.20 mm rechts, 0.96 mm tief
 Streuwert: 3.14, horizontal: 3.63, vertikal: 2.55

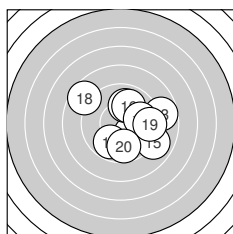

Serie 2:
 10.2 * 9.8 ↙ 8.7 → 10.0 ↑ 8.9 ↘
 10.0 ↗ 9.9 → 8.6 ↖ 9.4 → 9.7 ↓
 beste Teiler: 188.8 (11.), 243.2 (14.), 250.9 (16.)
 Trefferlage: 1.34 mm rechts, 0.02 mm hoch
 Streuwert: 2.66, horizontal: 2.99, vertikal: 2.30

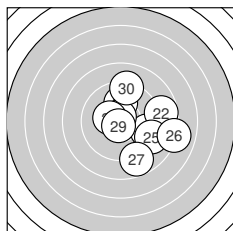

Serie 3:
 9.5 → 8.7 → 10.0 ↑ 10.7 * 9.1 ↘
 8.0 → 8.8 ↓ 10.3 * 10.7 * 9.2 ↑
 beste Teiler: 61.1 (24.), 67.1 (29.), 152.7 (28.)
 Trefferlage: 2.11 mm rechts, 0.19 mm tief
 Streuwert: 2.73, horizontal: 2.82, vertikal: 2.64

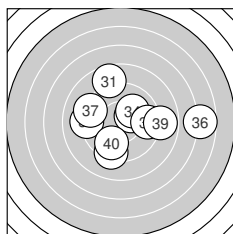

Serie 4:
 8.7 ↑ 10.3 * 9.1 ← 10.1 ↗ 9.5 →
 6.7 → 9.2 ↖ 9.3 ↓ 8.8 → 9.7 ↓
 beste Teiler: 161.8 (32.), 217.2 (34.), 301.3 (40.)
 Trefferlage: 0.99 mm rechts, 0.26 mm hoch
 Streuwert: 3.72, horizontal: 4.60, vertikal: 2.55



Ergebnis: **365.2** (343)
 Serien: 90.0 88.9 92.4 93.9
 Zähler: 5 21 6 8 0 0 0 0 0 0
 Innenzehner: 4
 Weitester: 969 (12.), 795 (31.), 780 (36.)
 beste Teiler: 95.0 (35.), 111.7 (17.), 164.7 (22.)
 Trefferlage: 0.24 mm rechts, 0.17 mm hoch
 Streuwert: 3.61, horizontal: 4.27, vertikal: 2.81

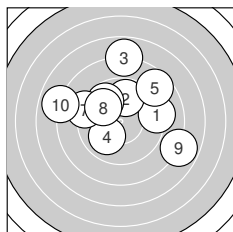
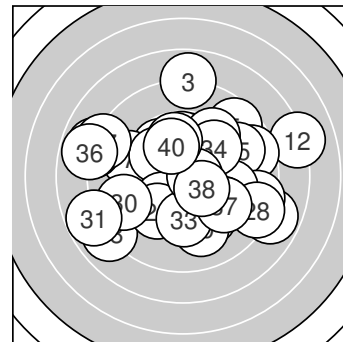

Serie 1:
 9.2 → 9.8 ↑ 7.9 ↑ 10.0 ↙ 8.6 ↗
 9.7 ↘ 9.1 ← 9.9 ↘ 7.9 → 7.9 ←
 beste Teiler: 244.1 (4.), 271.5 (8.), 288.5 (2.)
 Trefferlage: 0.06 mm links, 1.80 mm hoch
 Streuwert: 3.73, horizontal: 4.34, vertikal: 3.00

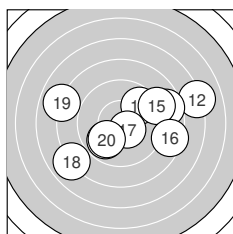

Serie 2:
 9.8 ↙ 7.1 → 8.6 → 9.7 ↗ 9.0 ↗
 8.5 → 10.5 * 7.9 ↙ 7.9 ↘ 9.9 ↙
 beste Teiler: 111.7 (17.), 255.8 (20.), 277.6 (11.)
 Trefferlage: 1.16 mm rechts, 0.03 mm hoch
 Streuwert: 4.19, horizontal: 5.33, vertikal: 2.59

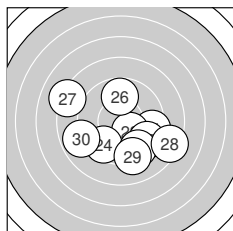

Serie 3:
 9.4 → 10.3 * 9.4 ↘ 9.6 ↙ 9.4 ↘
 9.8 ↑ 8.1 ← 8.3 → 9.2 ↘ 8.9 ←
 beste Teiler: 164.7 (22.), 297.1 (26.), 350.6 (24.)
 Trefferlage: 0.42 mm rechts, 1.38 mm tief
 Streuwert: 3.24, horizontal: 3.87, vertikal: 2.44

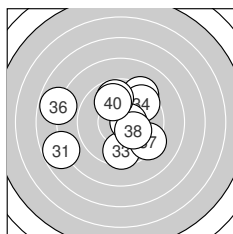

Serie 4:
 7.8 ↙ 9.3 ↗ 9.6 ↓ 9.6 ↗ 10.6 *
 7.8 ← 9.3 ↘ 10.2 * 9.8 ↑ 9.9 ↑
 beste Teiler: 95.0 (35.), 181.9 (38.), 259.6 (40.)
 Trefferlage: 0.56 mm links, 0.26 mm hoch
 Streuwert: 3.30, horizontal: 3.85, vertikal: 2.65



Ergebnis: **387.1** (368)
 Serien: 96.7 94.3 99.7 96.4
 Zähler: 15 19 5 1 0 0 0 0 0 0
 Innenzehner: 12
 Weitestе: 771 (38.), 671 (37.), 654 (27.)
 beste Teiler: 67.4 (35.), 68.4 (21.), 70.0 (34.)
 Trefferlage: 0.77 mm rechts, 0.45 mm tief
 Streuwert: 2.53, horizontal: 3.01, vertikal: 1.92

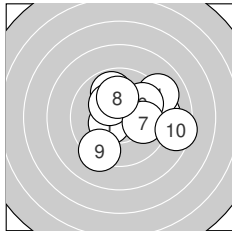
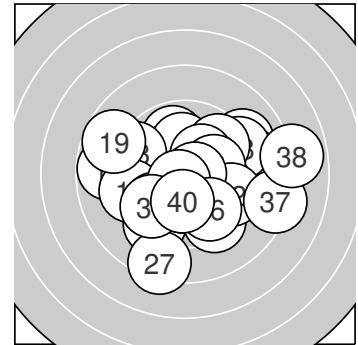

Serie 1:

10.5 *	9.9 ↑	9.3 →	9.1 ↗	10.3 *
9.8 ↗	9.9 →	10.1 ↑	9.3 ↘	8.5 →

beste Teiler: 125.8 (1.), 173.0 (5.), 214.1 (8.)
 Trefferlage: 1.39 mm rechts, 0.43 mm hoch
 Streuwert: 2.42, horizontal: 2.82, vertikal: 1.95

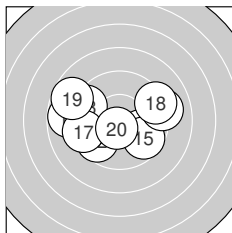

Serie 2:

8.8 ←	9.6 ↙	9.4 ↖	9.9 ↘	9.7 ↘
9.1 →	9.3 ←	9.2 ↗	8.7 ↖	10.6 *

beste Teiler: 90.4 (20.), 252.2 (14.), 319.6 (15.)
 Trefferlage: 0.73 mm links, 0.00 mm
 Streuwert: 2.93, horizontal: 3.80, vertikal: 1.65

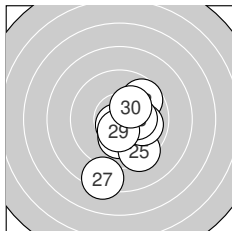

Serie 3:

10.7 *	9.7 ↗	10.2 *	10.5 *	9.4 ↘
10.0 →	8.3 ↓	10.2 *	10.5 *	10.2 *

beste Teiler: 68.4 (21.), 113.7 (24.), 123.5 (29.)
 Trefferlage: 0.77 mm rechts, 1.16 mm tief
 Streuwert: 1.94, horizontal: 1.41, vertikal: 2.36

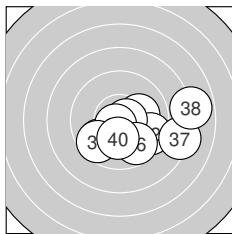

Serie 4:

10.1 →	9.5 ↘	9.7 ↙	10.7 *	10.7 *
9.7 ↘	8.3 →	7.9 →	9.6 ↙	10.2 *

beste Teiler: 67.4 (35.), 70.0 (34.), 193.8 (40.)
 Trefferlage: 1.67 mm rechts, 1.08 mm tief
 Streuwert: 2.54, horizontal: 3.34, vertikal: 1.34



Ergebnis: **377.8** (359)
 Serien: 94.8 93.3 93.2 96.5
 Zähler: 11 19 8 2 0 0 0 0 0 0
 Innenzehner: 4
 Weitester: 823 (8.), 752 (16.), 734 (18.)
 beste Teiler: 124.8 (38.), 147.2 (27.), 148.9 (9.)
 Trefferlage: 0.28 mm rechts, 0.02 mm tief
 Streuwert: 2.97, horizontal: 3.34, vertikal: 2.55

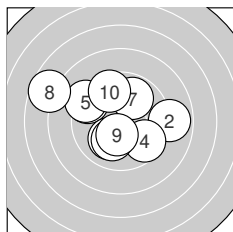
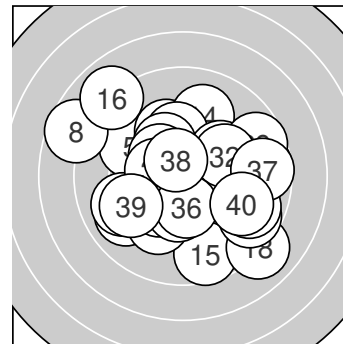

Serie 1:
 9.3 ↘ 8.9 → 10.1 ↙ 9.6 ↘ 9.2 ↖
 10.1 ↙ 9.9 ↗ 7.7 ↖ 10.4 * 9.6 ↗
 beste Teiler: 148.9 (9.), 216.1 (6.), 222.1 (3.)
 Trefferlage: 0.94 mm links, 0.56 mm hoch
 Streuwert: 2.98, horizontal: 3.56, vertikal: 2.25

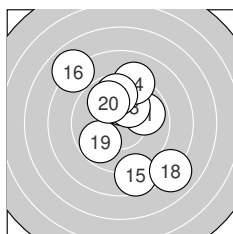

Serie 2:
 9.9 → 10.1 ↑ 10.1 ↑ 9.2 ↑ 8.7 ↓
 7.9 ↘ 9.7 ↑ 8.0 ↘ 9.8 ↙ 9.9 ↖
 beste Teiler: 201.2 (13.), 201.4 (12.), 260.2 (20.)
 Trefferlage: 0.29 mm rechts, 0.73 mm hoch
 Streuwert: 3.31, horizontal: 2.81, vertikal: 3.74

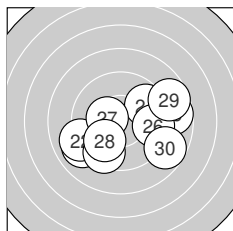

Serie 3:
 9.0 ↙ 9.1 ↙ 9.5 ↙ 9.7 ↗ 8.7 →
 9.5 → 10.4 * 9.9 ↙ 8.7 → 8.7 ↘
 beste Teiler: 147.2 (27.), 267.2 (28.), 316.5 (24.)
 Trefferlage: 0.83 mm rechts, 0.83 mm tief
 Streuwert: 3.09, horizontal: 3.87, vertikal: 2.02

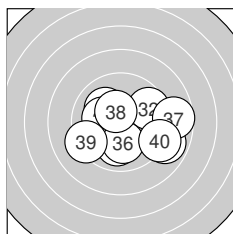

Serie 4:
 8.9 ↘ 9.6 ↗ 10.1 ↘ 10.2 * 10.0 ↓
 10.1 ↓ 8.7 → 10.5 * 9.3 ↙ 9.1 ↘
 beste Teiler: 124.8 (38.), 194.0 (34.), 216.4 (36.)
 Trefferlage: 0.96 mm rechts, 0.58 mm tief
 Streuwert: 2.55, horizontal: 3.19, vertikal: 1.70



Ergebnis: **396.1** (379)
 Serien: 97.2 98.8 99.7 100.4
 Zähler: 21 17 2 0 0 0 0 0 0 0
 Innenzehner: 15
 Weitestе: 734 (29.), 687 (9.), 498 (32.)
 beste Teiler: 58.8 (21.), 73.4 (27.), 76.6 (20.)
 Trefferlage: 0.29 mm rechts, 0.19 mm hoch
 Streuwert: 2.12, horizontal: 2.49, vertikal: 1.68

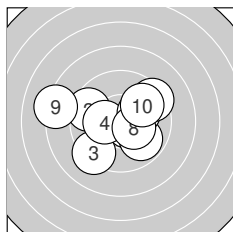
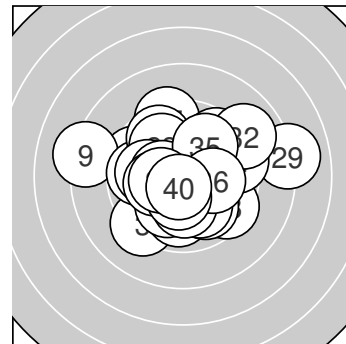

Serie 1:
 10.6 * 9.5 ↖ 9.2 ↗
 10.1 ↗ 9.4 ↗ 10.3 *
 beste Teiler: 91.4 (1.), 151.6 (8.), 165.3 (4.)
 Trefferlage: 0.28 mm links, 0.10 mm hoch
 Streuwert: 2.56, horizontal: 3.19, vertikal: 1.72

10.3 * 9.8 ↘
 8.2 ↖ 9.8 ↗

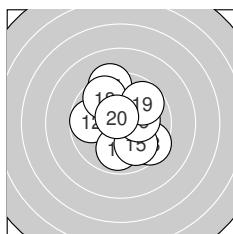

Serie 2:
 10.3 * 9.7 ← 9.5 ↘
 10.2 * 9.3 ↗ 9.7 ↖
 beste Teiler: 76.6 (20.), 154.4 (11.), 186.7 (16.)
 Trefferlage: 0.30 mm rechts, 0.42 mm hoch
 Streuwert: 2.05, horizontal: 1.91, vertikal: 2.17

9.9 ↓ 9.9 ↘
 9.7 ↗ 10.6 *

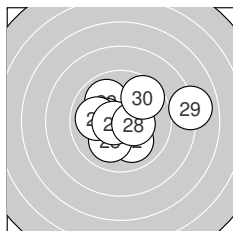

Serie 3:
 10.7 * 10.0 ↘ 9.9 ↖
 10.0 ← 10.7 * 10.4 *
 beste Teiler: 58.8 (21.), 73.4 (27.), 136.1 (28.)
 Trefferlage: 0.53 mm rechts, 0.17 mm hoch
 Streuwert: 2.24, horizontal: 2.79, vertikal: 1.49

10.3 * 10.1 ↗
 8.0 → 9.6 ↗

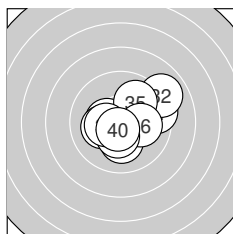

Serie 4:
 9.4 → 9.0 ↗ 10.4 *
 10.1 → 10.2 * 10.4 *
 beste Teiler: 80.4 (40.), 142.4 (33.), 148.8 (38.)
 Trefferlage: 0.61 mm rechts, 0.07 mm hoch
 Streuwert: 1.85, horizontal: 2.15, vertikal: 1.49

10.1 ↓ 9.9 ↗
 10.3 * 10.6 *



Ergebnis: **379.0** (361)
 Serien: 92.1 94.3 97.6 95.0
 Zähler: 11 21 6 2 0 0 0 0 0 0
 Innenzehner: 5
 Weitestе: 977 (8.), 794 (16.), 671 (31.)
 beste Teiler: 66.1 (1.), 68.9 (27.), 75.4 (30.)
 Trefferlage: 0.20 mm links, 0.87 mm hoch
 Streuwert: 2.92, horizontal: 3.26, vertikal: 2.55

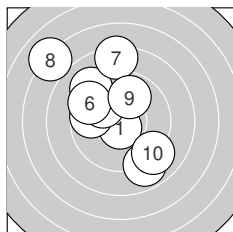
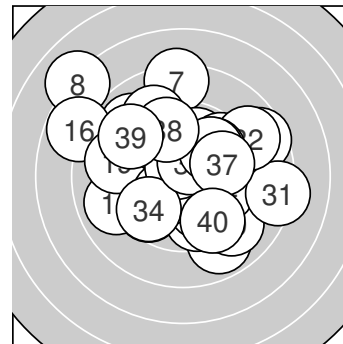

Serie 1:
 10.7 * 9.7 ← 10.0 ↘ 9.1 ↘ 8.9 ↘
 9.4 ↘ 8.3 ↑ 7.0 ↘ 9.9 ↑ 9.1 ↘
 beste Teiler: 66.1 (1.), 240.7 (3.), 268.9 (9.)
 Trefferlage: 1.22 mm links, 1.44 mm hoch
 Streuwert: 3.43, horizontal: 3.17, vertikal: 3.67

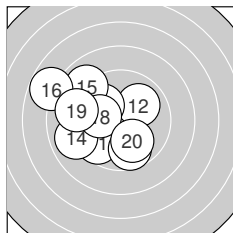

Serie 2:
 9.6 ↙ 10.0 ↗ 10.0 ↘ 9.0 ← 9.0 ↘
 7.8 ↘ 9.7 ↓ 10.1 ← 9.1 ← 10.0 ↘
 beste Teiler: 219.8 (18.), 241.4 (13.), 243.4 (12.)
 Trefferlage: 2.23 mm links, 0.20 mm hoch
 Streuwert: 2.67, horizontal: 2.93, vertikal: 2.38

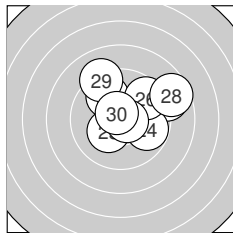

Serie 3:
 10.1 → 8.9 → 9.9 ↘ 9.8 → 10.2 *
 9.6 ↗ 10.7 * 8.6 → 9.1 ↘ 10.7 *
 beste Teiler: 68.9 (27.), 75.4 (30.), 176.7 (25.)
 Trefferlage: 1.30 mm rechts, 1.10 mm hoch
 Streuwert: 2.23, horizontal: 2.60, vertikal: 1.78

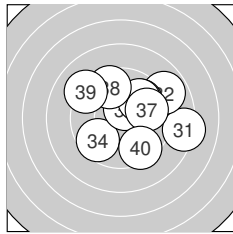

Serie 4:
 8.3 → 8.9 ↗ 9.8 ↗ 9.6 ↙ 10.5 *
 9.9 ↗ 9.8 → 9.6 ↘ 9.1 ↘ 9.5 ↘
 beste Teiler: 106.4 (35.), 269.4 (36.), 278.6 (33.)
 Trefferlage: 1.32 mm rechts, 0.75 mm hoch
 Streuwert: 2.70, horizontal: 3.11, vertikal: 2.21



Ergebnis: **150.8** (140)
 Serien: 71.4 79.4
 Zähler: 3 0 7 3 1 4 1 1 0 0
 Innenzehner: 2
 Weitester: 1851 (6.), 1608 (10.), 1475 (2.)
 beste Teiler: 44.3 (1.), 52.9 (15.), 221.7 (7.)
 Trefferlage: 0.08 mm rechts, 0.10 mm tief
 Streuwert: 7.20, horizontal: 7.56, vertikal: 6.83

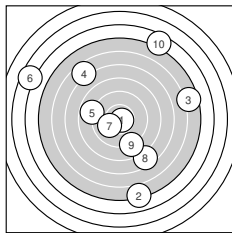
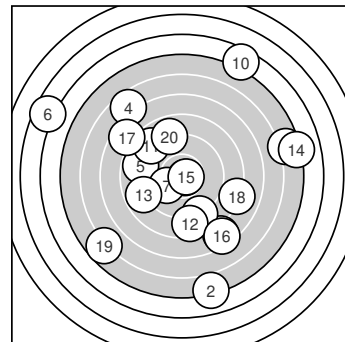

Serie 1:

10.8 *	5.1 ↓	5.6 →	6.6 ↖	8.8 ←
3.5 ↙	10.1 ↖	7.5 ↘	8.9 ↓	4.5 ↗

beste Teiler: 44.3 (1.), 221.7 (7.), 522.5 (9.)
 Trefferlage: 0.09 mm rechts, 0.81 mm hoch
 Streuwert: 8.33, horizontal: 8.32, vertikal: 8.35

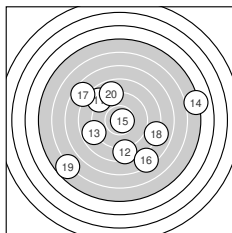

Serie 2:

8.8 ↖	8.5 ↓	8.8 ←	5.1 →	10.7 *
7.3 ↘	7.6 ↖	8.0 →	5.7 ↖	8.9 ↗

beste Teiler: 52.9 (15.), 520.9 (20.), 534.0 (13.)
 Trefferlage: 0.08 mm rechts, 1.01 mm tief
 Streuwert: 6.26, horizontal: 7.17, vertikal: 5.19



Ergebnis: **356.3** (336)
 Serien: 87.5 87.7 91.6 89.5
 Zähler: 9 10 14 3 3 1 0 0 0 0
 Innenzehner: 7
 Weitester: 1300 (17.), 1135 (26.), 1080 (36.)
 beste Teiler: 49.3 (35.), 63.2 (16.), 79.6 (29.)
 Trefferlage: 1.34 mm links, 0.23 mm tief
 Streuwert: 4.11, horizontal: 5.15, vertikal: 2.70

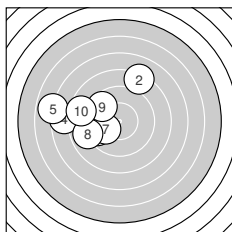
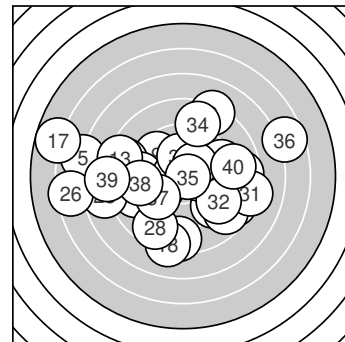

Serie 1:

8.6 ←	8.2 ↗	9.6 ←	7.6 ←	6.9 ←
9.5 ←	10.0 ←	8.9 ←	9.6 ↘	8.6 ←

beste Teiler: 237.7 (7.), 336.9 (3.), 341.9 (9.)
 Trefferlage: 4.30 mm links, 0.85 mm hoch
 Streuwert: 3.04, horizontal: 3.57, vertikal: 2.39

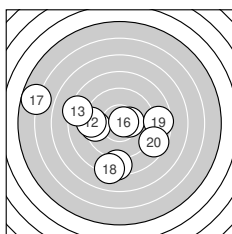

Serie 2:

9.5 ←	9.2 ←	8.3 ↖	8.4 ↓	10.4 *
10.7 *	5.8 ↖	8.2 ↓	8.6 →	8.6 ↘

beste Teiler: 63.2 (16.), 146.9 (15.), 365.7 (11.)
 Trefferlage: 1.56 mm links, 1.01 mm tief
 Streuwert: 4.52, horizontal: 5.46, vertikal: 3.33

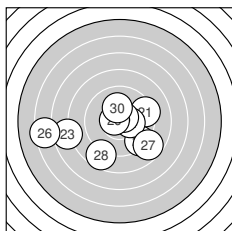

Serie 3:

9.3 →	9.3 ↘	7.7 ←	10.3 *	10.6 *
6.4 ←	8.7 ↘	8.6 ↙	10.6 *	10.1 ↑

beste Teiler: 79.6 (29.), 82.0 (25.), 159.6 (24.)
 Trefferlage: 0.96 mm links, 1.13 mm tief
 Streuwert: 3.93, horizontal: 5.07, vertikal: 2.29

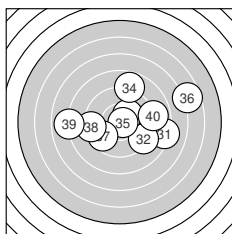

Serie 4:

8.2 →	9.2 ↘	10.3 *	8.8 ↑	10.8 *
6.6 →	9.6 ↙	9.2 ←	7.9 ←	8.9 →

beste Teiler: 49.3 (35.), 165.5 (33.), 326.7 (37.)
 Trefferlage: 1.43 mm rechts, 0.36 mm hoch
 Streuwert: 4.14, horizontal: 5.30, vertikal: 2.49



Ergebnis: **355.8** (340)
 Serien: 87.2 89.8 88.3 90.5
 Zähler: 7 16 11 4 1 0 1 0 0 0
 Innenzehner: 5
 Weitester: 1691 (5.), 1077 (7.), 906 (34.)
 beste Teiler: 91.8 (29.), 115.8 (8.), 119.2 (35.)
 Trefferlage: 1.02 mm links, 0.51 mm tief
 Streuwert: 4.19, horizontal: 4.91, vertikal: 3.31

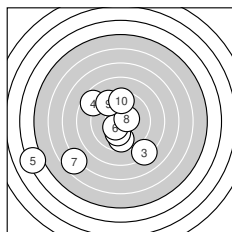
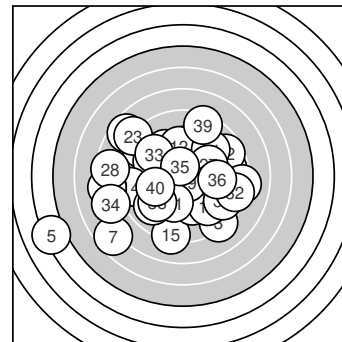

Serie 1:
 9.7 ↓ 10.1 ↓ 8.2 ↘ 8.6 ↖ 4.2 ←
 10.4 * 6.6 ↗ 10.5 * 9.4 ↗ 9.5 ↑
 beste Teiler: 115.8 (8.), 137.5 (6.), 212.9 (2.)
 Trefferlage: 2.65 mm links, 1.52 mm tief
 Streuwert: 4.92, horizontal: 5.61, vertikal: 4.11

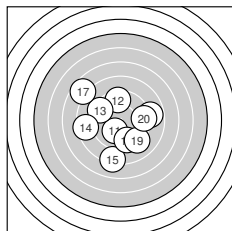

Serie 2:
 10.1 ↙ 9.5 ↑ 9.4 ↖ 8.4 ← 8.1 ↓
 8.8 → 7.6 ↖ 9.5 ↓ 9.1 ↘ 9.3 →
 beste Teiler: 211.6 (11.), 359.2 (12.), 364.6 (18.)
 Trefferlage: 0.59 mm links, 0.53 mm tief
 Streuwert: 3.83, horizontal: 4.05, vertikal: 3.59

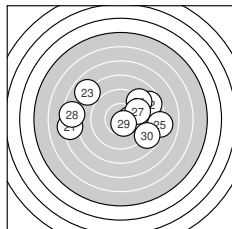

Serie 3:
 7.4 ← 8.7 ↗ 8.0 ↖ 9.2 ↗ 8.2 →
 10.3 * 9.6 ↗ 7.5 ← 10.6 * 8.8 ↘
 beste Teiler: 91.8 (29.), 172.0 (26.), 329.3 (27.)
 Trefferlage: 0.18 mm rechts, 0.68 mm hoch
 Streuwert: 4.42, horizontal: 5.81, vertikal: 2.32

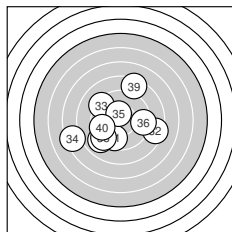

Serie 4:
 9.6 ↓ 8.4 → 9.2 ↖ 7.3 ← 10.5 *
 9.3 → 9.0 ↗ 9.2 ↗ 8.4 ↑ 9.6 ←
 beste Teiler: 119.2 (35.), 330.4 (31.), 348.2 (40.)
 Trefferlage: 1.05 mm links, 0.66 mm tief
 Streuwert: 3.73, horizontal: 4.27, vertikal: 3.10



Ergebnis: **401.4** (384)
 Serien: 101.8 101.3 99.7 98.6
 Zähler: 25 14 1 0 0 0 0 0 0
 Innenzehner: 17
 Weitester: 513 (24.), 477 (37.), 421 (8.)
 beste Teiler: 28.8 (19.), 30.0 (1.), 41.7 (5.)
 Trefferlage: 0.41 mm links, 0.65 mm hoch
 Streuwert: 1.76, horizontal: 2.02, vertikal: 1.45

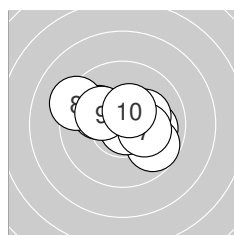
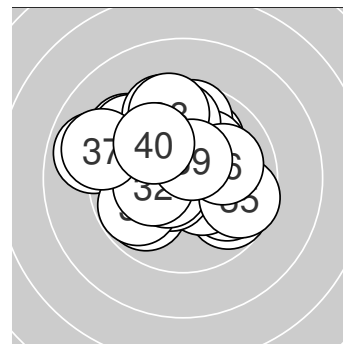

Serie 1:
 10.8 * 10.0 → 9.7 ↘ 10.1 ↖ 10.8 *
 10.2 * 10.2 * 9.3 ↖ 10.2 * 10.5 *
 beste Teiler: 30.0 (1.), 41.7 (5.), 125.6 (10.)
 Trefferlage: 0.20 mm rechts, 0.26 mm hoch
 Streuwert: 1.66, horizontal: 2.11, vertikal: 1.01

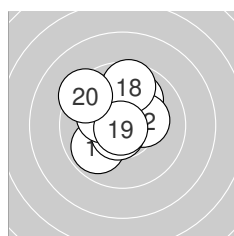

Serie 2:
 10.0 ↗ 10.3 * 10.0 ↘ 9.9 ↙ 10.6 *
 10.4 * 10.2 * 9.7 ↑ 10.8 * 9.4 ↘
 beste Teiler: 28.8 (19.), 76.8 (15.), 148.5 (16.)
 Trefferlage: 0.62 mm links, 0.92 mm hoch
 Streuwert: 1.51, horizontal: 1.48, vertikal: 1.54

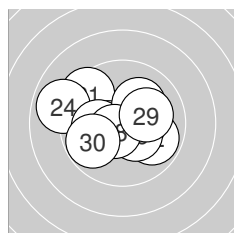

Serie 3:
 9.4 ↘ 9.9 ↘ 10.4 * 8.9 ↖ 10.1 ←
 10.4 * 10.1 ↗ 10.6 * 10.1 → 9.8 ↙
 beste Teiler: 96.1 (28.), 126.8 (23.), 141.8 (26.)
 Trefferlage: 0.73 mm links, 0.10 mm hoch
 Streuwert: 1.95, horizontal: 2.41, vertikal: 1.32

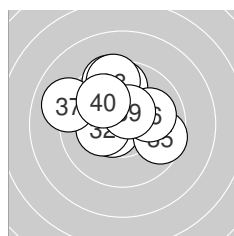

Serie 4:
 10.6 * 10.3 * 9.5 ↑ 9.7 ↑ 9.6 →
 10.0 → 9.0 ↖ 9.5 ↑ 10.5 * 9.9 ↘
 beste Teiler: 99.1 (31.), 113.1 (39.), 168.8 (32.)
 Trefferlage: 0.48 mm links, 1.34 mm hoch
 Streuwert: 1.92, horizontal: 2.13, vertikal: 1.69



Ergebnis: **324.3** (308)
 Serien: 82.9 85.8 82.0 73.6
 Zähler: 3 11 9 9 5 2 1 0 0 0
 Innenzehner: 2
 Weitester: 1667 (40.), 1430 (1.), 1397 (12.)
 beste Teiler: 105.5 (18.), 160.8 (23.), 206.1 (15.)
 Trefferlage: 3.56 mm rechts, 1.70 mm tief
 Streuwert: 4.88, horizontal: 6.05, vertikal: 3.33

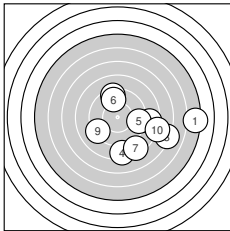
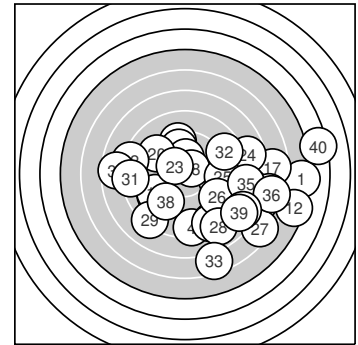

Serie 1:

5.2 →	8.6 →	9.3 ↑	8.3 ↓	9.4 →
9.6 ↑	8.3 ↓	7.1 →	9.2 ↙	7.9 →

beste Teiler: 332.5 (6.), 397.5 (5.), 411.3 (3.)
 Trefferlage: 3.93 mm rechts, 1.52 mm tief
 Streuwert: 4.50, horizontal: 5.39, vertikal: 3.39

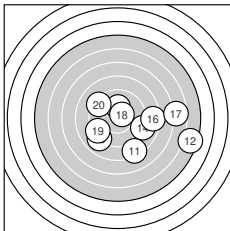

Serie 2:

8.3 ↓	5.4 →	9.0 ↘	9.0 →	10.1 ↑
8.4 →	6.7 →	10.5 *	9.2 ↙	9.2 ↘

beste Teiler: 105.5 (18.), 206.1 (15.), 429.2 (20.)
 Trefferlage: 2.87 mm rechts, 1.18 mm tief
 Streuwert: 4.68, horizontal: 5.97, vertikal: 2.85

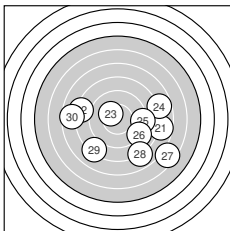

Serie 3:

7.7 →	8.2 ←	10.3 *	7.7 →	9.1 →
9.0 ↘	6.4 ↘	7.9 ↓	8.1 ↙	7.6 ←

beste Teiler: 160.8 (23.), 463.8 (25.), 483.5 (26.)
 Trefferlage: 1.68 mm rechts, 1.77 mm tief
 Streuwert: 5.12, horizontal: 6.38, vertikal: 3.41

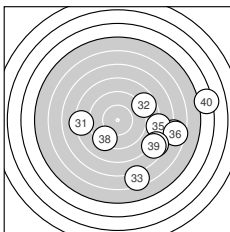

Serie 4:

8.3 ←	8.7 ↗	6.5 ↓	6.7 →	7.9 →
6.6 →	7.6 ↘	9.3 ↙	7.7 ↘	4.3 →

beste Teiler: 407.8 (38.), 556.2 (32.), 669.0 (31.)
 Trefferlage: 5.78 mm rechts, 2.31 mm tief
 Streuwert: 5.43, horizontal: 6.56, vertikal: 4.00



Ergebnis: **399.4** (379)
 Serien: 101.4 98.7 99.8 99.5
 Zähler: 20 19 1 0 0 0 0 0 0
 Innenzehner: 16
 Weitesten: 577 (16.), 489 (26.), 460 (6.)
 beste Teiler: 11.1 (20.), 36.6 (32.), 65.3 (29.)
 Trefferlage: 0.40 mm rechts, 0.22 mm hoch
 Streuwert: 1.92, horizontal: 2.35, vertikal: 1.36

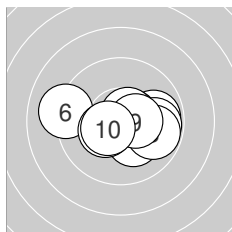
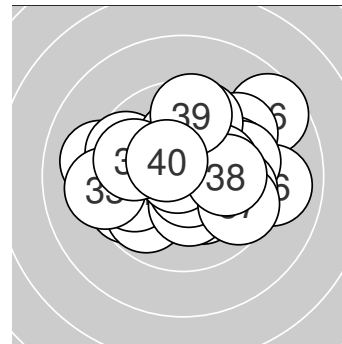

Serie 1:
 9.9 → 10.6 * 10.6 * 10.2 * 9.8 →
 9.1 ← 10.4 * 9.8 ↘ 10.5 * 10.5 *
 beste Teiler: 80.6 (3.), 94.5 (2.), 119.9 (10.)
 Trefferlage: 0.50 mm rechts, 0.19 mm tief
 Streuwert: 1.69, horizontal: 2.28, vertikal: 0.74

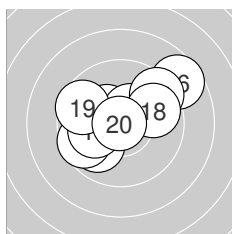

Serie 2:
 9.9 ↙ 10.4 * 9.6 ↙ 10.1 ← 10.4 *
 8.6 ↗ 9.4 ↗ 9.8 → 9.6 ↖ 10.9 *
 beste Teiler: 11.1 (20.), 127.8 (15.), 148.3 (12.)
 Trefferlage: 0.03 mm links, 0.61 mm hoch
 Streuwert: 2.24, horizontal: 2.72, vertikal: 1.63

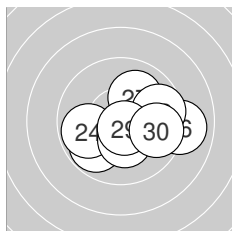

Serie 3:
 10.6 * 9.8 ↙ 10.2 * 9.8 ← 10.3 *
 9.0 → 10.0 ↗ 9.7 → 10.7 * 9.7 →
 beste Teiler: 65.3 (29.), 89.8 (21.), 163.7 (25.)
 Trefferlage: 1.08 mm rechts, 0.39 mm tief
 Streuwert: 1.81, horizontal: 2.30, vertikal: 1.12

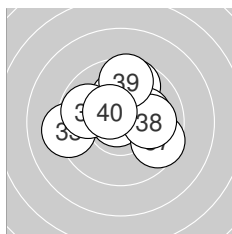

Serie 4:
 9.7 ↑ 10.8 * 9.2 ← 10.1 → 10.2 *
 9.8 ↖ 9.6 ↘ 10.0 → 9.6 ↑ 10.5 *
 beste Teiler: 36.6 (32.), 123.0 (40.), 195.6 (35.)
 Trefferlage: 0.04 mm rechts, 0.87 mm hoch
 Streuwert: 1.94, horizontal: 2.27, vertikal: 1.53



Ergebnis: **402.4** (382)
 Serien: 100.6 99.6 101.6 100.6
 Zähler: 25 14 0 0 1 0 0 0 0 0
 Innenzehner: 21
 Weitester: 1168 (14.), 442 (27.), 440 (6.)
 beste Teiler: 14.1 (7.), 41.4 (1.), 42.1 (28.)
 Trefferlage: 0.01 mm links, 0.07 mm hoch
 Streuwert: 2.09, horizontal: 1.97, vertikal: 2.20

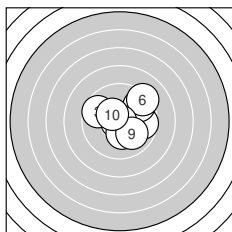
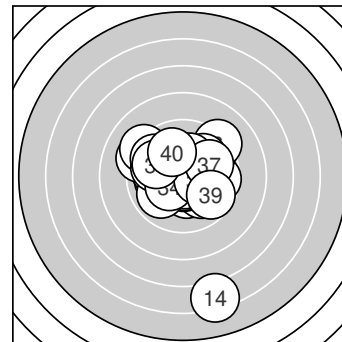

Serie 1:
 10.8 * 10.1 ↗ 9.6 ↖
 9.2 ↗ 10.9 * 10.3 *
 beste Teiler: 14.1 (7.), 41.4 (1.), 140.0 (10.)
 Trefferlage: 0.87 mm rechts, 0.46 mm hoch
 Streuwert: 1.79, horizontal: 2.02, vertikal: 1.52

9.7 → 9.6 ↗
 10.0 ↘ 10.4 *

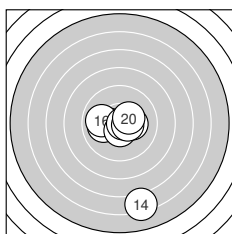

Serie 2:
 10.4 * 10.5 * 10.3 * 6.3 ↓ 10.0 ←
 9.9 ← 10.5 * 10.8 * 10.5 * 10.4 *

10.5 * 10.4 *

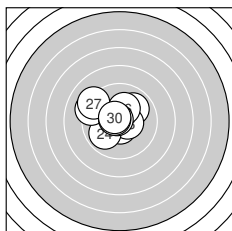

Serie 3:
 10.6 * 9.9 ↗ 10.5 * 9.9 ↙ 9.2 ↖
 10.2 * 9.2 ↖ 10.8 * 10.7 * 10.6 *

10.7 * 10.6 *

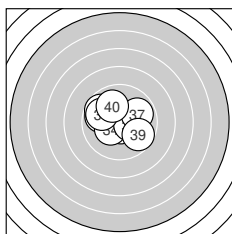

Serie 4:
 9.9 ↖ 10.6 * 10.2 * 10.3 * 10.4 *
 9.7 ↖ 9.9 ↗ 9.9 ↖ 9.7 ↘ 10.0 ↘
 beste Teiler: 79.8 (32.), 148.4 (35.), 157.8 (34.)
 Trefferlage: 0.43 mm links, 0.44 mm hoch
 Streuwert: 1.70, horizontal: 2.01, vertikal: 1.32

10.3 * 10.4 *
 9.7 ↘ 10.0 ↘



Ergebnis: **401.2** (383)
 Serien: 101.1 98.9 99.2 102.0
 Zähler: 25 14 0 1 0 0 0 0 0 0
 Innenzehner: 20
 Weitester: 817 (27.), 479 (11.), 463 (7.)
 beste Teiler: 33.5 (3.), 65.5 (39.), 69.1 (9.)
 Trefferlage: 0.89 mm links, 0.03 mm hoch
 Streuwert: 1.85, horizontal: 2.18, vertikal: 1.45

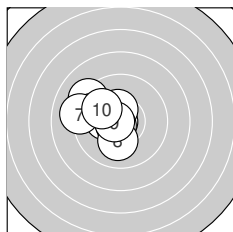
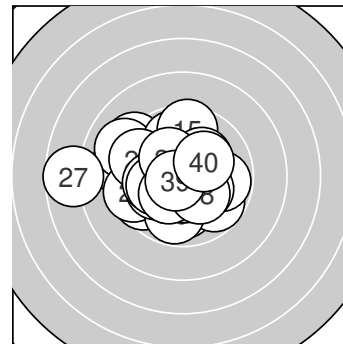

Serie 1:
 9.9 ↘ 9.2 ↘ 10.8 * 10.3 * 10.4 *
 10.7 * 9.1 ← 10.1 ↓ 10.7 * 9.9 ↘
 beste Teiler: 33.5 (3.), 69.1 (9.), 71.4 (6.)
 Trefferlage: 1.63 mm links, 0.47 mm hoch
 Streuwert: 1.40, horizontal: 1.51, vertikal: 1.29

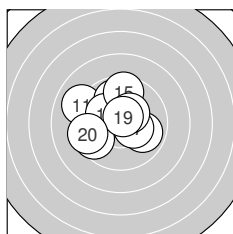

Serie 2:
 9.0 ↘ 9.9 ↑ 10.2 * 9.6 ↙ 9.6 ↑
 9.9 ↘ 10.3 * 10.4 * 10.6 * 9.4 ←
 beste Teiler: 79.1 (19.), 150.1 (18.), 154.7 (17.)
 Trefferlage: 0.78 mm links, 0.66 mm hoch
 Streuwert: 2.04, horizontal: 2.30, vertikal: 1.75

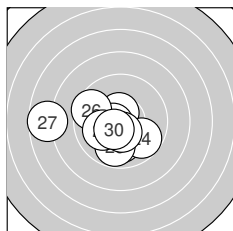

Serie 3:
 10.6 * 10.0 ↓ 10.6 * 9.8 ↘ 9.8 ↓
 9.6 ↘ 7.7 ← 10.1 ← 10.5 * 10.5 *
 beste Teiler: 87.3 (23.), 95.9 (21.), 117.2 (30.)
 Trefferlage: 1.32 mm links, 0.82 mm tief
 Streuwert: 2.20, horizontal: 2.81, vertikal: 1.34

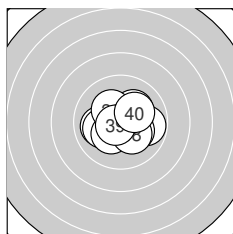

Serie 4:
 10.0 ← 10.1 ← 10.3 * 9.8 → 10.2 *
 10.3 * 10.2 * 10.2 * 10.7 * 10.2 *
 beste Teiler: 65.5 (39.), 167.7 (33.), 171.4 (36.)
 Trefferlage: 0.16 mm rechts, 0.16 mm tief
 Streuwert: 1.44, horizontal: 1.75, vertikal: 1.05



Ergebnis: **393.2** (377)
 Serien: 98.5 101.0 94.5 99.2
 Zähler: 21 16 2 1 0 0 0 0 0 0
 Innenzehner: 17
 Weitester: 955 (27.), 528 (21.), 516 (10.)
 beste Teiler: 45.9 (13.), 78.8 (34.), 81.0 (24.)
 Trefferlage: 0.02 mm rechts, 0.29 mm hoch
 Streuwert: 2.35, horizontal: 3.01, vertikal: 1.40

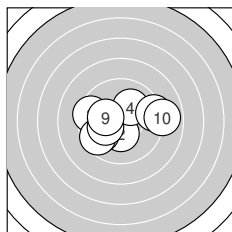
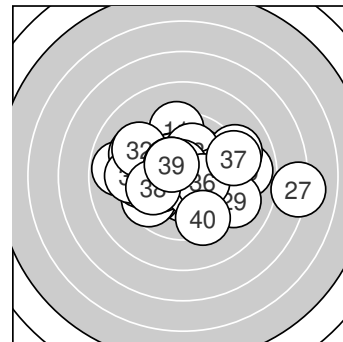

Serie 1:
 10.6 * 10.4 * 9.4 ↖ 10.1 ↗ 9.3 →
 9.8 ↙ 9.6 ↙ 10.2 * 10.2 * 8.9 →
 beste Teiler: 84.0 (1.), 150.0 (2.), 190.1 (9.)
 Trefferlage: 0.29 mm links, 0.11 mm tief
 Streuwert: 2.27, horizontal: 2.96, vertikal: 1.25

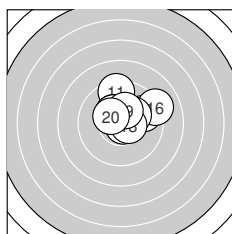

Serie 2:
 9.4 ↑ 10.3 * 10.8 * 9.7 ↗ 10.3 *
 9.1 ↗ 10.2 * 10.5 * 10.3 * 10.4 *
 beste Teiler: 45.9 (13.), 102.1 (18.), 146.0 (20.)
 Trefferlage: 0.70 mm rechts, 1.24 mm hoch
 Streuwert: 1.51, horizontal: 1.77, vertikal: 1.18

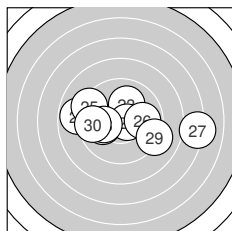

Serie 3:
 8.8 ← 10.0 ← 10.1 ↑ 10.6 * 9.2 ↖
 9.9 → 7.1 → 10.1 ← 9.1 ↘ 9.6 ←
 beste Teiler: 81.0 (24.), 210.0 (28.), 222.9 (23.)
 Trefferlage: 0.11 mm rechts, 0.00 mm
 Streuwert: 3.28, horizontal: 4.46, vertikal: 1.25

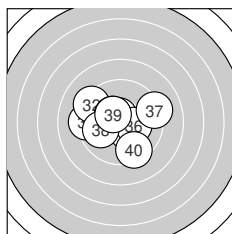

Serie 4:
 9.3 ← 9.3 ↖ 10.4 * 10.6 * 10.4 *
 10.3 * 9.2 ↗ 9.9 ↙ 10.4 * 9.4 ↘
 beste Teiler: 78.8 (34.), 132.2 (39.), 136.5 (35.)
 Trefferlage: 0.40 mm links, 0.03 mm hoch
 Streuwert: 2.16, horizontal: 2.59, vertikal: 1.62



Ergebnis: **379.2** (362)
 Serien: 92.9 97.0 92.5 96.8
 Zähler: 11 24 2 2 1 0 0 0 0 0
 Innenzehner: 5
 Weitestе: 1189 (26.), 938 (28.), 783 (8.)
 beste Teiler: 11.7 (17.), 123.2 (38.), 136.2 (29.)
 Trefferlage: 0.62 mm rechts, 0.13 mm hoch
 Streuwert: 3.00, horizontal: 3.33, vertikal: 2.64

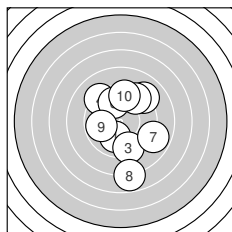
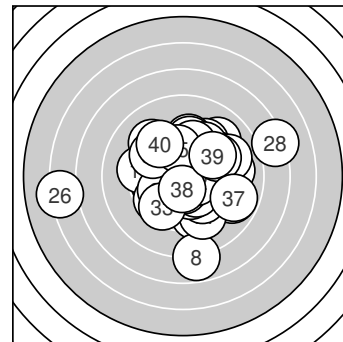

Serie 1:
 10.0 ↙ 9.1 ↗ 9.4 ↓ 9.2 ↘ 9.4 ↗
 9.8 ↖ 8.9 ↘ 7.8 ↓ 9.8 ← 9.5 ↑
 beste Teiler: 236.2 (1.), 282.5 (6.), 283.0 (9.)
 Trefferlage: 0.56 mm rechts, 0.05 mm tief
 Streuwert: 3.27, horizontal: 2.48, vertikal: 3.90

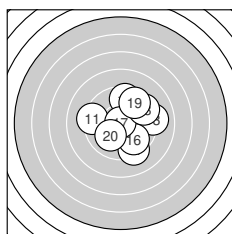

Serie 2:
 9.3 ← 10.1 → 9.1 → 9.3 ↓ 9.5 ↑
 9.8 ↘ 10.9 * 9.4 ↗ 9.5 ↗ 10.1 ↖
 beste Teiler: 11.7 (17.), 208.1 (12.), 225.8 (20.)
 Trefferlage: 1.07 mm rechts, 0.10 mm hoch
 Streuwert: 2.39, horizontal: 2.47, vertikal: 2.31

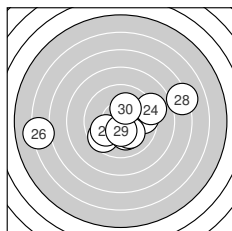

Serie 3:
 9.6 → 9.6 ↖ 10.1 ↓ 9.1 → 10.0 ↖
 6.2 ← 10.1 ↘ 7.2 → 10.4 * 10.2 *
 beste Teiler: 136.2 (29.), 195.3 (30.), 202.0 (23.)
 Trefferlage: 0.28 mm rechts, 0.29 mm tief
 Streuwert: 4.03, horizontal: 5.36, vertikal: 1.93

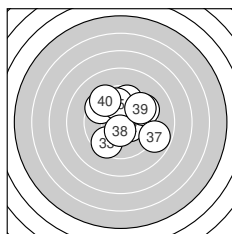

Serie 4:
 9.5 ↘ 10.4 * 9.5 ↙ 9.7 ↑ 9.9 ↑
 9.5 ↗ 8.8 → 10.5 * 9.6 ↗ 9.4 ↘
 beste Teiler: 123.2 (38.), 139.7 (32.), 269.8 (35.)
 Trefferlage: 0.55 mm rechts, 0.78 mm hoch
 Streuwert: 2.42, horizontal: 2.57, vertikal: 2.25



Ergebnis: **370.2** (354)
 Serien: 96.0 94.2 86.7 93.3
 Zähler: 10 19 6 5 0 0 0 0 0 0
 Innenzehner: 6
 Weitester: 992 (16.), 943 (5.), 921 (22.)
 beste Teiler: 89.0 (10.), 124.2 (6.), 135.3 (19.)
 Trefferlage: 0.83 mm rechts, 0.83 mm hoch
 Streuwert: 3.37, horizontal: 4.27, vertikal: 2.10

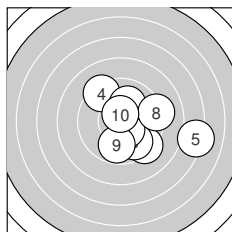
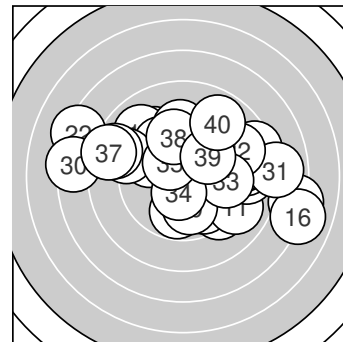

Serie 1:
 10.2 * 9.3 ↘ 9.8 ↘ 9.3 ↘ 7.2 →
 10.5 * 10.1 ↑ 9.2 → 9.8 ↓ 10.6 *
 beste Teiler: 89.0 (10.), 124.2 (6.), 180.0 (1.)
 Trefferlage: 1.86 mm rechts, 0.39 mm tief
 Streuwert: 2.74, horizontal: 3.17, vertikal: 2.23

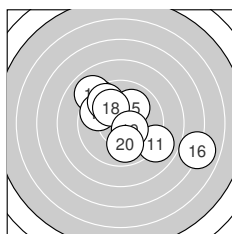

Serie 2:
 9.0 ↘ 9.4 ↘ 9.0 ↘ 9.7 ↘ 10.0 ↗
 7.0 → 9.7 ↘ 10.1 ↘ 10.4 * 9.9 ↓
 beste Teiler: 135.3 (19.), 222.8 (18.), 231.1 (15.)
 Trefferlage: 0.48 mm rechts, 0.52 mm hoch
 Streuwert: 3.30, horizontal: 3.91, vertikal: 2.55

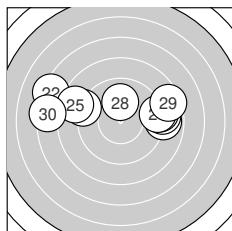

Serie 3:
 8.9 → 7.3 ↖ 8.9 → 9.0 ↖ 8.6 ↖
 9.0 → 9.1 → 10.0 ↑ 8.5 → 7.4 ←
 beste Teiler: 233.0 (28.), 461.4 (27.), 489.3 (24.)
 Trefferlage: 0.21 mm links, 1.51 mm hoch
 Streuwert: 4.38, horizontal: 6.10, vertikal: 1.04

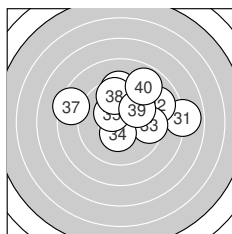

Serie 4:
 7.9 → 9.0 ↗ 9.5 → 10.4 * 10.3 *
 9.4 ↑ 8.4 ↖ 9.6 ↑ 9.9 ↗ 8.9 ↗
 beste Teiler: 138.0 (34.), 152.7 (35.), 258.4 (39.)
 Trefferlage: 1.19 mm rechts, 1.71 mm hoch
 Streuwert: 2.94, horizontal: 3.74, vertikal: 1.82



Ergebnis: **357.9** (340)
 Serien: 88.5 86.6 90.7 92.1
 Zähler: 5 19 10 3 3 0 0 0 0 0
 Innenzehner: 3
 Weitester: 1181 (13.), 1113 (5.), 1050 (4.)
 beste Teiler: 24.6 (22.), 41.3 (9.), 142.8 (32.)
 Trefferlage: 0.85 mm links, 1.83 mm tief
 Streuwert: 3.82, horizontal: 4.60, vertikal: 2.84

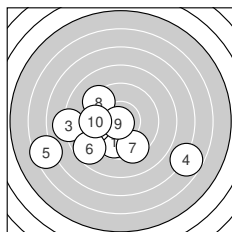
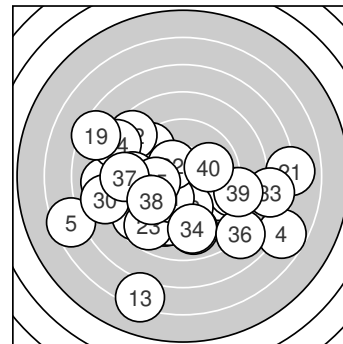

Serie 1:
 9.8 ↘ 9.5 ← 8.1 ← 6.8 ↘ 6.5 ←
 8.7 ↗ 9.4 ↘ 9.3 ↘ 10.8 * 9.6 ←
 beste Teiler: 41.3 (9.), 295.0 (1.), 349.0 (10.)
 Trefferlage: 2.23 mm links, 1.83 mm tief
 Streuwert: 4.08, horizontal: 5.22, vertikal: 2.45

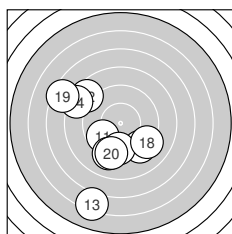

Serie 2:
 9.7 ↗ 8.6 ↘ 6.2 ↓ 8.2 ↘ 9.3 ↘
 9.6 ↓ 9.2 ↓ 9.2 ↘ 7.4 ↘ 9.2 ↓
 beste Teiler: 304.2 (11.), 350.8 (16.), 418.5 (15.)
 Trefferlage: 2.20 mm links, 2.01 mm tief
 Streuwert: 4.14, horizontal: 3.66, vertikal: 4.57

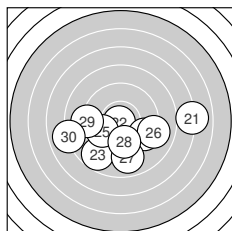

Serie 3:
 7.0 → 10.9 * 8.7 ↗ 9.5 ↘ 9.8 ←
 9.0 → 8.9 ↓ 9.8 ↓ 9.1 ← 8.0 ←
 beste Teiler: 24.6 (22.), 286.7 (25.), 289.5 (28.)
 Trefferlage: 0.15 mm rechts, 1.87 mm tief
 Streuwert: 3.72, horizontal: 4.93, vertikal: 1.82

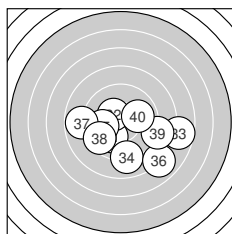

Serie 4:
 10.0 ↗ 10.4 * 7.7 → 9.0 ↓ 9.9 ←
 8.0 ↘ 8.8 ← 9.5 ↗ 8.8 → 10.0 →
 beste Teiler: 142.8 (32.), 233.0 (31.), 250.7 (40.)
 Trefferlage: 0.86 mm rechts, 1.60 mm tief
 Streuwert: 3.36, horizontal: 4.25, vertikal: 2.14



Ergebnis: **375.5** (357)
 Serien: 94.2 95.0 95.4 90.9
 Zähler: 15 11 10 4 0 0 0 0 0 0
 Innenzehner: 12
 Weitester: 916 (5.), 790 (37.), 786 (34.)
 beste Teiler: 30.8 (8.), 39.8 (30.), 91.7 (15.)
 Trefferlage: 0.00 mm , 1.46 mm tief
 Streuwert: 3.11, horizontal: 3.66, vertikal: 2.44

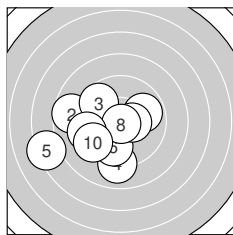
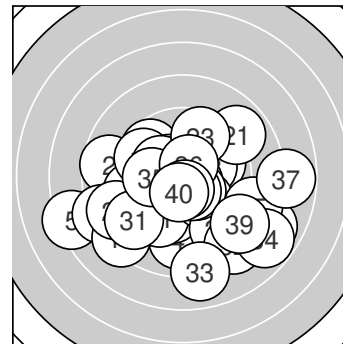

Serie 1:
 9.9 ↗ 8.7 ← 9.6 ↘ 9.0 ↓ 7.3 ↙
 9.8 ↓ 10.4 * 10.8 * 9.3 ← 9.4 ↙
 beste Teiler: 30.8 (8.), 132.8 (7.), 272.8 (1.)
 Trefferlage: 2.10 mm links, 1.12 mm tief
 Streuwert: 2.84, horizontal: 3.35, vertikal: 2.22

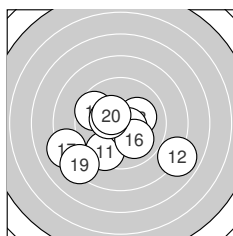

Serie 2:
 9.5 ↙ 7.9 ↘ 10.1 ↗ 9.6 ↘ 10.6 *
 10.0 ↘ 8.2 ← 10.4 * 8.3 ↙ 10.4 *
 beste Teiler: 91.7 (15.), 142.4 (20.), 143.8 (18.)
 Trefferlage: 0.74 mm links, 1.33 mm tief
 Streuwert: 3.02, horizontal: 3.65, vertikal: 2.23

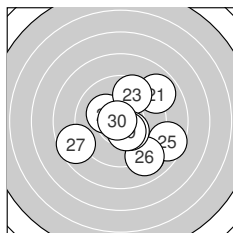

Serie 3:
 8.9 ↗ 10.2 * 9.6 ↑ 9.0 ↘ 8.6 ↗
 9.0 ↘ 8.6 ← 10.3 * 10.4 * 10.8 *
 beste Teiler: 39.8 (30.), 133.0 (29.), 152.8 (28.)
 Trefferlage: 1.08 mm rechts, 0.79 mm tief
 Streuwert: 2.81, horizontal: 3.02, vertikal: 2.57

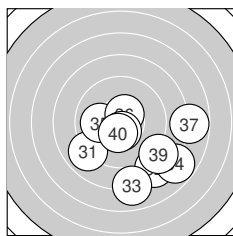

Serie 4:
 8.9 ↙ 8.3 ↘ 8.0 ↓ 7.8 ↘ 10.0 ←
 10.5 * 7.8 → 10.5 * 8.7 ↘ 10.4 *
 beste Teiler: 101.5 (36.), 102.9 (38.), 127.5 (40.)
 Trefferlage: 1.78 mm rechts, 2.59 mm tief
 Streuwert: 3.25, horizontal: 3.73, vertikal: 2.67



Ergebnis: **413.5** (395)
 Serien: 103.3 104.3 102.9 103.0
 Zähler: 35 5 0 0 0 0 0 0 0 0
 Innenzehner: 29
 Weitestе: 308 (31.), 275 (1.), 275 (28.)
 beste Teiler: 7.2 (5.), 34.0 (33.), 34.9 (37.)
 Trefferlage: 0.11 mm rechts, 0.17 mm hoch
 Streuwert: 1.22, horizontal: 1.27, vertikal: 1.16

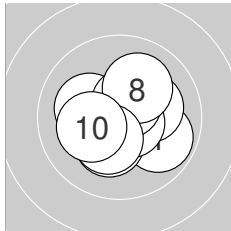
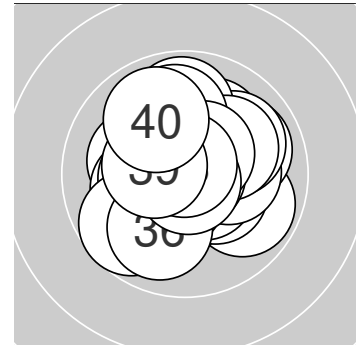

Serie 1:

9.9 ↘	10.1 ←	10.2 *	10.3 *	10.9 *
10.7 *	10.6 *	10.1 ↗	10.3 *	10.2 *

beste Teiler: 7.2 (5.), 72.9 (6.), 100.1 (7.)
 Trefferlage: 0.13 mm rechts, 0.12 mm tief
 Streuwert: 1.30, horizontal: 1.45, vertikal: 1.12

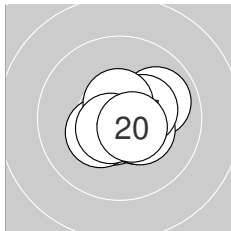

Serie 2:

9.9 ↗	10.6 *	10.5 *	10.5 *	10.3 *
10.4 *	10.3 *	10.6 *	10.6 *	10.6 *

beste Teiler: 85.9 (12.), 86.4 (19.), 92.4 (18.)
 Trefferlage: 0.56 mm rechts, 0.13 mm tief
 Streuwert: 0.95, horizontal: 1.09, vertikal: 0.77

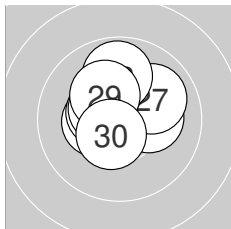

Serie 3:

10.4 *	10.4 *	10.2 *	10.4 *	10.4 *
10.5 *	10.0 ↗	9.9 ↑	10.2 *	10.5 *

beste Teiler: 111.0 (30.), 123.7 (26.), 126.8 (25.)
 Trefferlage: 0.11 mm rechts, 0.67 mm hoch
 Streuwert: 1.20, horizontal: 1.36, vertikal: 1.01

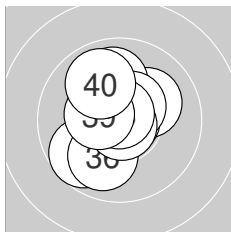

Serie 4:

9.7 ↙	10.1 ↗	10.8 *	10.0 ↑	10.5 *
10.0 ↓	10.8 *	10.8 *	10.4 *	9.9 ↘

beste Teiler: 34.0 (33.), 34.9 (37.), 41.1 (38.)
 Trefferlage: 0.34 mm links, 0.28 mm hoch
 Streuwert: 1.39, horizontal: 1.17, vertikal: 1.57



Ergebnis: **405.9** (391)
 Serien: 100.3 101.9 103.0 100.7
 Zähler: 32 7 1 0 0 0 0 0 0
 Innenzehner: 23
 Weitester: 507 (6.), 464 (33.), 409 (17.)
 beste Teiler: 32.3 (39.), 46.0 (29.), 59.4 (19.)
 Trefferlage: 0.33 mm rechts, 0.46 mm hoch
 Streuwert: 1.57, horizontal: 1.78, vertikal: 1.32

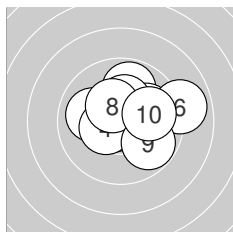
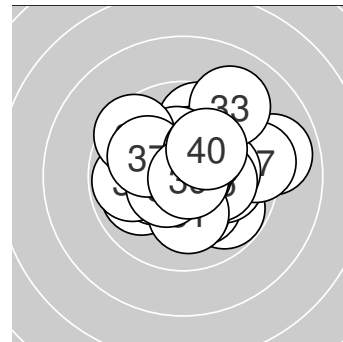

Serie 1:
 10.7 * 9.8 ↑ 10.0 ← 10.4 * 10.0 →
 8.9 → 10.3 * 10.4 * 9.8 ↘ 10.0 →
 beste Teiler: 72.8 (1.), 131.7 (4.), 145.8 (8.)
 Trefferlage: 0.78 mm rechts, 0.62 mm hoch
 Streuwert: 1.76, horizontal: 2.16, vertikal: 1.25

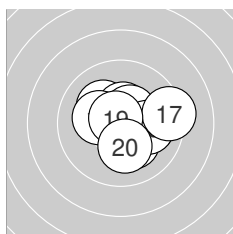

Serie 2:
 10.2 * 10.0 → 10.2 * 10.5 * 10.5 *
 10.1 → 9.3 → 10.2 * 10.7 * 10.2 *
 beste Teiler: 59.4 (19.), 119.6 (14.), 120.7 (15.)
 Trefferlage: 0.71 mm rechts, 0.10 mm hoch
 Streuwert: 1.48, horizontal: 1.77, vertikal: 1.12

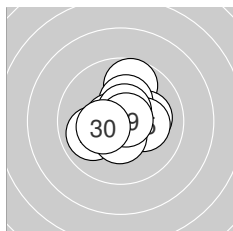

Serie 3:
 9.7 ↑ 10.1 → 10.0 ← 10.3 * 10.2 *
 10.6 * 10.4 * 10.6 * 10.8 * 10.3 *
 beste Teiler: 46.0 (29.), 79.4 (26.), 90.8 (28.)
 Trefferlage: 0.13 mm rechts, 0.28 mm hoch
 Streuwert: 1.31, horizontal: 1.36, vertikal: 1.26

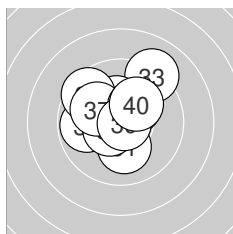

Serie 4:
 10.1 ↓ 9.8 ← 9.1 ↗ 10.3 * 9.5 ↘
 10.5 * 10.1 ↖ 10.3 * 10.8 * 10.2 *
 beste Teiler: 32.3 (39.), 107.9 (36.), 164.5 (34.)
 Trefferlage: 0.30 mm links, 0.86 mm hoch
 Streuwert: 1.73, horizontal: 1.79, vertikal: 1.66



Ergebnis: **398.2** (383)
 Serien: 97.3 98.9 102.8 99.2
 Zähler: 23 17 0 0 0 0 0 0 0 0
 Innenzehner: 14
 Weitester: 469 (13.), 449 (5.), 413 (37.)
 beste Teiler: 48.1 (27.), 76.0 (28.), 82.0 (29.)
 Trefferlage: 0.05 mm links, 0.36 mm hoch
 Streuwert: 1.92, horizontal: 2.21, vertikal: 1.59

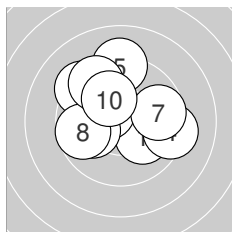
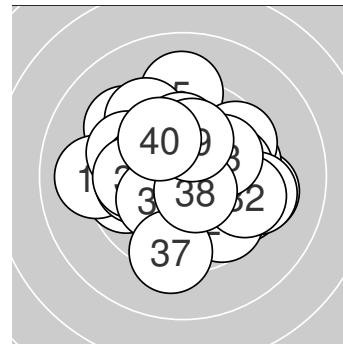

Serie 1:

10.1 ↘	9.3 ↘	10.4 *	9.3 →	9.2 ↑
10.0 ←	9.7 →	9.7 ←	9.5 ↘	10.1 ↘

beste Teiler: 131.4 (3.), 205.2 (10.), 216.3 (1.)
 Trefferlage: 0.36 mm links, 0.98 mm hoch
 Streuwert: 2.26, horizontal: 2.53, vertikal: 1.96

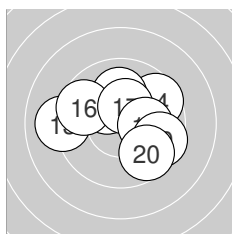

Serie 2:

10.3 *	10.3 *	9.1 ←	9.6 ↗	10.0 ↑
9.7 ↖	10.4 *	10.2 *	9.6 →	9.7 ↘

beste Teiler: 142.4 (17.), 162.0 (11.), 174.2 (12.)
 Trefferlage: 0.12 mm rechts, 0.57 mm hoch
 Streuwert: 2.10, horizontal: 2.56, vertikal: 1.51

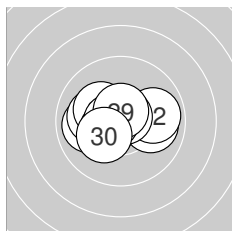

Serie 3:

10.0 →	9.9 →	9.9 ←	10.1 ←	10.2 *
10.4 *	10.8 *	10.6 *	10.6 *	10.3 *

beste Teiler: 48.1 (27.), 76.0 (28.), 82.0 (29.)
 Trefferlage: 0.39 mm links, 0.05 mm hoch
 Streuwert: 1.33, horizontal: 1.76, vertikal: 0.66

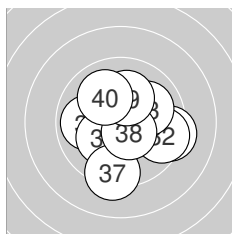

Serie 4:

9.3 →	9.6 →	10.0 ↗	9.9 ←	10.3 *
10.2 *	9.3 ↓	10.5 *	10.1 ↑	10.0 ↘

beste Teiler: 104.9 (38.), 166.6 (35.), 184.7 (36.)
 Trefferlage: 0.40 mm rechts, 0.15 mm tief
 Streuwert: 2.01, horizontal: 2.13, vertikal: 1.89



Ergebnis: **363.4** (346)
 Serien: 90.7 87.0 94.2 91.5
 Zähler: 6 17 15 1 1 0 0 0 0 0
 Innenzehner: 3
 Weitestе: 1059 (13.), 762 (17.), 730 (14.)
 beste Teiler: 128.8 (35.), 173.0 (38.), 183.4 (9.)
 Trefferlage: 0.09 mm links, 2.34 mm tief
 Streuwert: 3.17, horizontal: 3.49, vertikal: 2.81

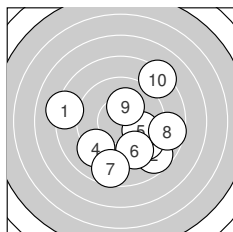
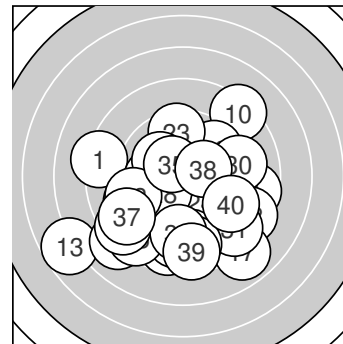

Serie 1:
 8.2 ← 8.7 ↘ 9.4 ↘ 9.2 ↙ 9.9 →
 9.4 ↘ 8.7 ↓ 8.7 → 10.2 * 8.3 ↗
 beste Teiler: 183.4 (9.), 264.5 (5.), 377.6 (3.)
 Trefferlage: 1.07 mm rechts, 1.27 mm tief
 Streuwert: 3.48, horizontal: 3.75, vertikal: 3.19

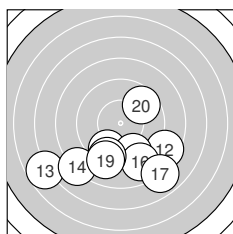

Serie 2:
 9.6 ↙ 8.5 ↘ 6.7 ↙ 8.0 ↙ 9.4 ↘
 8.9 ↘ 7.9 ↘ 9.3 ↓ 9.1 ↓ 9.6 ↗
 beste Teiler: 328.0 (20.), 343.9 (11.), 377.6 (15.)
 Trefferlage: 0.29 mm links, 3.70 mm tief
 Streuwert: 3.55, horizontal: 4.46, vertikal: 2.30

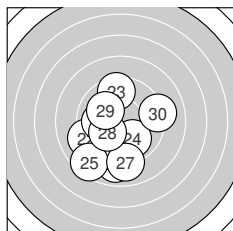

Serie 3:
 8.9 ↓ 9.1 ← 9.5 ↑ 9.9 ↘ 8.5 ↙
 10.0 ← 9.0 ↓ 10.1 ↙ 10.1 ↘ 9.1 →
 beste Teiler: 204.3 (28.), 221.1 (29.), 241.0 (26.)
 Trefferlage: 0.82 mm links, 1.44 mm tief
 Streuwert: 2.74, horizontal: 2.53, vertikal: 2.93

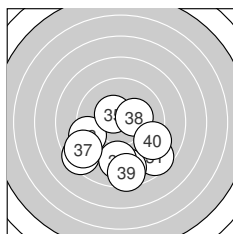

Serie 4:
 8.6 ↘ 8.8 ↓ 9.3 ← 8.5 ↙ 10.4 *
 9.1 ↓ 8.8 ↙ 10.3 * 8.5 ↓ 9.2 ↘
 beste Teiler: 128.8 (35.), 173.0 (38.), 424.4 (33.)
 Trefferlage: 0.33 mm links, 2.94 mm tief
 Streuwert: 2.82, horizontal: 3.21, vertikal: 2.36



Ergebnis: **399.2** (381)
 Serien: 99.2 98.9 99.4 101.7
 Zähler: 22 17 1 0 0 0 0 0 0 0
 Innenzehner: 18
 Weitester: 581 (9.), 472 (30.), 467 (13.)
 beste Teiler: 42.4 (27.), 66.6 (15.), 78.7 (35.)
 Trefferlage: 0.55 mm rechts, 0.33 mm tief
 Streuwert: 1.91, horizontal: 1.91, vertikal: 1.91

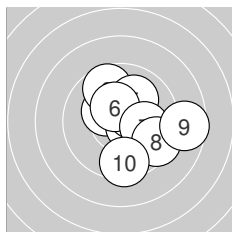
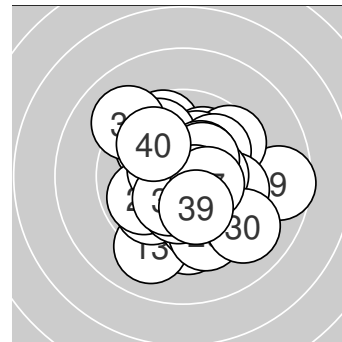

Serie 1:
 10.3 * 10.6 * 9.7 ↖ 10.5 * 10.0 ↗
 10.4 * 10.1 → 9.5 ↘ 8.6 → 9.5 ↓
 beste Teiler: 99.2 (2.), 125.5 (4.), 140.5 (6.)
 Trefferlage: 1.16 mm rechts, 0.08 mm hoch
 Streuwert: 2.05, horizontal: 2.16, vertikal: 1.92

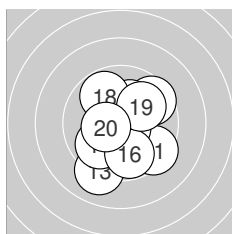

Serie 2:
 9.4 ↘ 9.6 ↗ 9.1 ↓ 9.9 ↗ 10.7 *
 9.8 ↓ 10.2 * 9.8 ↖ 10.0 ↗ 10.4 *
 beste Teiler: 66.6 (15.), 138.4 (20.), 190.0 (17.)
 Trefferlage: 0.31 mm rechts, 0.44 mm tief
 Streuwert: 2.12, horizontal: 1.89, vertikal: 2.33

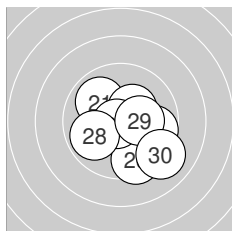

Serie 3:
 9.9 ↖ 10.5 * 10.3 * 9.7 → 9.4 ↘
 9.5 ↓ 10.8 * 9.9 ↖ 10.3 * 9.1 ↘
 beste Teiler: 42.4 (27.), 114.0 (22.), 152.7 (23.)
 Trefferlage: 0.99 mm rechts, 0.90 mm tief
 Streuwert: 1.87, horizontal: 1.98, vertikal: 1.75

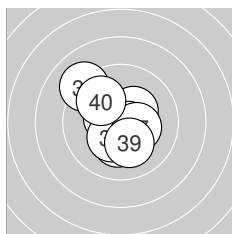

Serie 4:
 10.4 * 10.5 * 10.2 * 10.3 * 10.6 *
 10.3 * 10.3 * 9.1 ↖ 10.1 ↓ 9.9 ↖
 beste Teiler: 78.7 (35.), 118.9 (32.), 148.6 (31.)
 Trefferlage: 0.27 mm links, 0.08 mm tief
 Streuwert: 1.61, horizontal: 1.50, vertikal: 1.71



Ergebnis: **391.5** (372)
 Serien: 100.5 94.3 100.1 96.6
 Zähler: 21 11 7 1 0 0 0 0 0 0
 Innenzehner: 15
 Weitester: 890 (18.), 614 (39.), 608 (20.)
 beste Teiler: 32.7 (1.), 88.4 (22.), 90.1 (4.)
 Trefferlage: 0.14 mm links, 0.34 mm hoch
 Streuwert: 2.48, horizontal: 2.77, vertikal: 2.14

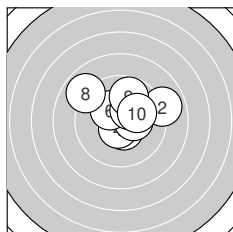
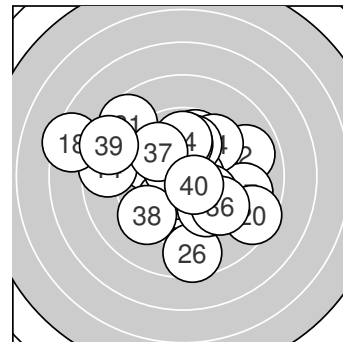

Serie 1:
 10.8 * 8.9 → 10.5 * 10.6 * 10.4 *
 10.2 * 10.3 * 8.9 ↘ 9.8 ↑ 10.1 →
 beste Teiler: 32.7 (1.), 90.1 (4.), 111.0 (3.)
 Trefferlage: 0.46 mm rechts, 0.92 mm hoch
 Streuwert: 1.90, horizontal: 2.27, vertikal: 1.44

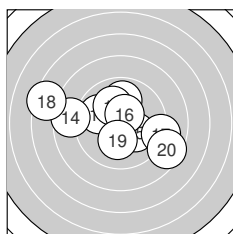

Serie 2:
 9.9 ↖ 9.9 ↑ 10.1 ↘ 8.6 ← 10.2 *
 10.5 * 9.0 → 7.4 ↖ 10.2 * 8.5 ↘
 beste Teiler: 114.2 (16.), 195.1 (19.), 199.2 (15.)
 Trefferlage: 0.57 mm links, 0.27 mm hoch
 Streuwert: 3.31, horizontal: 4.25, vertikal: 1.96

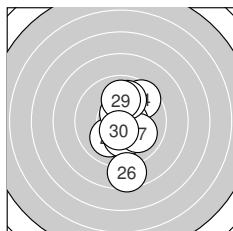

Serie 3:
 10.1 ↙ 10.6 * 10.2 * 9.6 ↗ 10.6 *
 8.6 ↓ 10.0 ↘ 9.9 ↑ 10.0 ↑ 10.5 *
 beste Teiler: 88.4 (22.), 91.0 (25.), 106.7 (30.)
 Trefferlage: 0.53 mm rechts, 0.37 mm tief
 Streuwert: 2.00, horizontal: 1.07, vertikal: 2.62

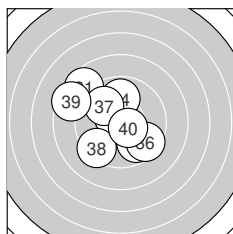

Serie 4:
 8.6 ↘ 10.0 ↑ 10.6 * 9.9 ↑ 9.8 ↘
 9.5 ↘ 9.9 ↖ 9.3 ↙ 8.5 ↖ 10.5 *
 beste Teiler: 97.2 (33.), 107.6 (40.), 226.2 (32.)
 Trefferlage: 1.01 mm links, 0.55 mm hoch
 Streuwert: 2.56, horizontal: 2.65, vertikal: 2.47



Ergebnis: **379.5** (364)
 Serien: 95.7 97.5 93.7 92.6
 Zähler: 17 15 5 2 0 1 0 0 0 0
 Innenzehner: 14
 Weitester: 1316 (23.), 953 (39.), 817 (17.)
 beste Teiler: 14.8 (29.), 71.1 (24.), 90.0 (27.)
 Trefferlage: 0.58 mm links, 0.28 mm tief
 Streuwert: 3.20, horizontal: 3.73, vertikal: 2.56

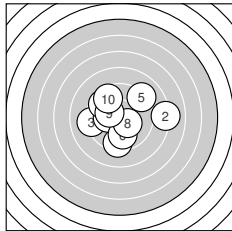
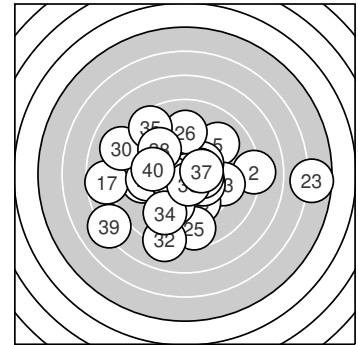

Serie 1:

9.4 ↓	8.1 →	9.2 ←	10.2 *	9.1 ↗
9.9 ↓	9.6 ↘	10.3 *	10.3 *	9.6 ↘

beste Teiler: 153.8 (8.), 173.2 (9.), 185.1 (4.)
 Trefferlage: 0.02 mm links, 0.06 mm hoch
 Streuwert: 2.86, horizontal: 3.33, vertikal: 2.29

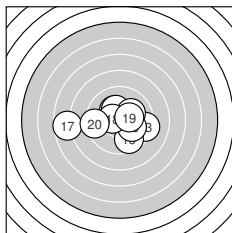

Serie 2:

10.2 *	10.3 *	9.3 →	10.1 ↗	9.6 ↓
10.1 ↘	7.7 ←	10.5 *	10.3 *	9.4 ←

beste Teiler: 113.3 (18.), 156.3 (19.), 172.7 (12.)
 Trefferlage: 0.40 mm links, 0.14 mm tief
 Streuwert: 2.66, horizontal: 3.48, vertikal: 1.41

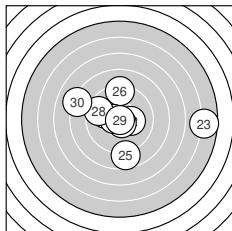

Serie 3:

10.0 ↖	10.2 *	5.7 →	10.7 *	8.7 ↓
9.2 ↑	10.6 *	9.6 ↖	10.9 *	8.1 ↖

beste Teiler: 14.8 (29.), 71.1 (24.), 90.0 (27.)
 Trefferlage: 0.32 mm rechts, 0.18 mm hoch
 Streuwert: 4.06, horizontal: 5.12, vertikal: 2.60

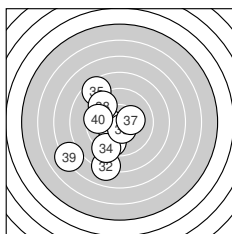

Serie 4:

9.6 ↓	8.1 ↓	10.3 *	9.1 ↓	8.5 ↘
10.5 *	10.3 *	9.5 ↘	7.1 ↖	9.6 ←

beste Teiler: 110.0 (36.), 154.2 (33.), 174.9 (37.)
 Trefferlage: 2.22 mm links, 1.25 mm tief
 Streuwert: 3.13, horizontal: 2.56, vertikal: 3.61



Ergebnis: **411.1** (393)
 Serien: 102.2 103.9 100.4 104.6
 Zähler: 33 7 0 0 0 0 0 0 0 0
 Innenzehner: 28
 Weitestе: 423 (7.), 377 (22.), 347 (10.)
 beste Teiler: 19.7 (5.), 47.8 (6.), 59.8 (21.)
 Trefferlage: 0.11 mm links, 0.18 mm tief
 Streuwert: 1.37, horizontal: 1.43, vertikal: 1.31

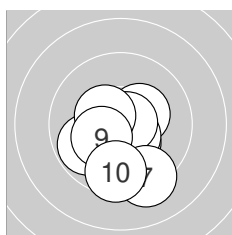
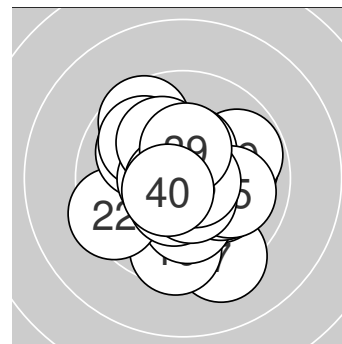

Serie 1:
 9.8 ↙ 10.3 * 10.3 * 10.5 * 10.9 *
 10.8 * 9.3 ↘ 10.4 * 10.3 * 9.6 ↓
 beste Teiler: 19.7 (5.), 47.8 (6.), 111.6 (4.)
 Trefferlage: 0.00 mm , 1.02 mm tief
 Streuwert: 1.46, horizontal: 1.32, vertikal: 1.58

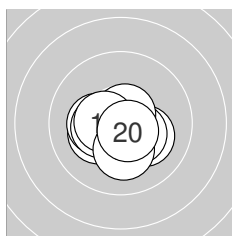

Serie 2:
 10.2 * 10.4 * 10.2 * 10.3 * 10.4 *
 10.4 * 10.7 * 10.5 * 10.2 * 10.6 *
 beste Teiler: 70.6 (17.), 77.8 (20.), 117.4 (18.)
 Trefferlage: 0.32 mm links, 0.46 mm tief
 Streuwert: 1.01, horizontal: 1.25, vertikal: 0.69

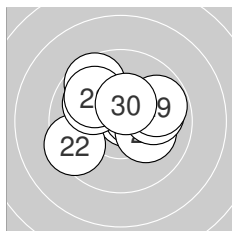

Serie 3:
 10.7 * 9.4 ↙ 10.5 * 10.1 ↘ 10.0 ↖
 9.6 ↘ 10.0 → 9.9 ↘ 9.8 → 10.4 *
 beste Teiler: 59.8 (21.), 109.1 (23.), 131.8 (30.)
 Trefferlage: 0.04 mm links, 0.70 mm hoch
 Streuwert: 1.74, horizontal: 2.11, vertikal: 1.27

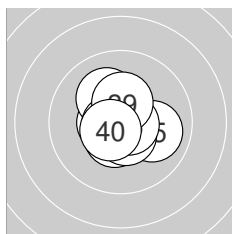

Serie 4:
 10.6 * 10.4 * 10.5 * 10.1 ↘ 10.0 →
 10.6 * 10.7 * 10.7 * 10.4 * 10.6 *
 beste Teiler: 60.4 (38.), 65.7 (37.), 94.6 (40.)
 Trefferlage: 0.09 mm links, 0.05 mm hoch
 Streuwert: 1.01, horizontal: 1.01, vertikal: 1.01



Ergebnis: **384.3** (362)
 Serien: 94.7 99.8 93.6 96.2
 Zähler: 11 20 9 0 0 0 0 0 0 0
 Innenzehner: 9
 Weitestе: 729 (39.), 608 (26.), 598 (29.)
 beste Teiler: 111.1 (13.), 122.1 (12.), 135.0 (7.)
 Trefferlage: 0.43 mm rechts, 0.99 mm hoch
 Streuwert: 2.55, horizontal: 3.09, vertikal: 1.85

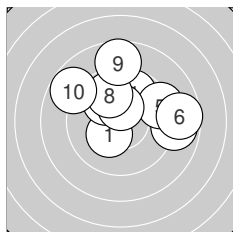
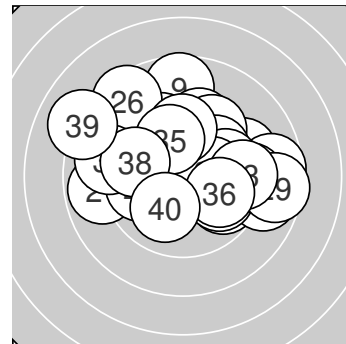

Serie 1:
 10.3 * 10.0 ↘ 8.9 → 9.8 ↑ 9.3 →
 8.7 → 10.4 * 9.8 ↗ 8.7 ↑ 8.8 ↘
 beste Teiler: 135.0 (7.), 166.5 (1.), 234.6 (2.)
 Trefferlage: 0.75 mm rechts, 1.74 mm hoch
 Streuwert: 2.69, horizontal: 3.25, vertikal: 1.98

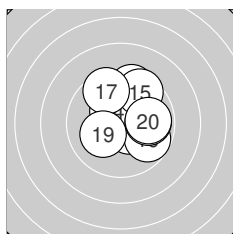

Serie 2:
 9.5 ↑ 10.5 * 10.5 * 10.4 * 9.5 ↑
 9.8 ↘ 9.6 ↘ 9.9 → 10.2 * 9.9 →
 beste Teiler: 111.1 (13.), 122.1 (12.), 139.8 (14.)
 Trefferlage: 0.72 mm rechts, 0.88 mm hoch
 Streuwert: 1.77, horizontal: 1.73, vertikal: 1.81

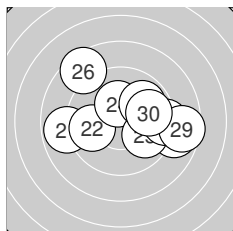

Serie 3:
 8.8 ← 9.8 ← 8.8 → 10.3 * 9.9 ↘
 8.5 ↘ 9.9 ↗ 9.2 → 8.6 → 9.8 →
 beste Teiler: 170.1 (24.), 269.5 (27.), 270.7 (25.)
 Trefferlage: 1.08 mm rechts, 0.41 mm hoch
 Streuwert: 3.06, horizontal: 3.86, vertikal: 1.94

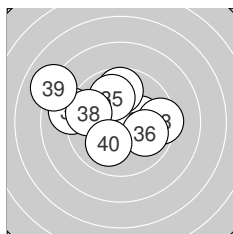

Serie 4:
 10.4 * 10.2 * 9.4 → 9.7 ↑ 9.9 ↗
 9.9 ↘ 9.0 ← 9.7 ← 8.0 ↘ 10.0 ↘
 beste Teiler: 136.0 (31.), 184.6 (32.), 232.9 (40.)
 Trefferlage: 0.83 mm links, 0.94 mm hoch
 Streuwert: 2.58, horizontal: 3.22, vertikal: 1.71



Ergebnis: **343.9** (325)
 Serien: 86.5 85.4 86.1 85.9
 Zähler: 4 13 13 5 4 1 0 0 0 0
 Innenzehner: 3
 Weitester: 1347 (12.), 1153 (35.), 1145 (9.)
 beste Teiler: 85.4 (27.), 90.8 (3.), 199.3 (20.)
 Trefferlage: 0.91 mm rechts, 0.05 mm tief
 Streuwert: 4.68, horizontal: 5.00, vertikal: 4.32

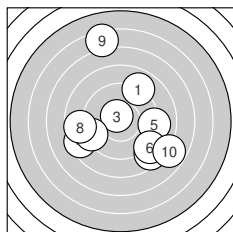
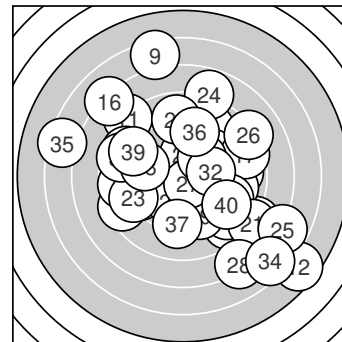

Serie 1:
 8.9 ↗ 8.5 ↘ 10.6 * 8.5 ← 9.1 →
 8.8 ↘ 9.2 ← 8.7 ← 6.4 ↑ 7.8 ↘
 beste Teiler: 90.8 (3.), 441.1 (7.), 466.8 (5.)
 Trefferlage: 0.36 mm rechts, 0.16 mm tief
 Streuwert: 4.69, horizontal: 4.60, vertikal: 4.79

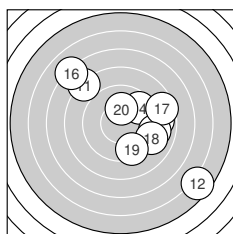

Serie 2:
 8.0 ↘ 5.6 ↘ 8.9 → 9.6 ↗ 9.0 →
 7.1 ↘ 8.5 → 9.1 ↘ 9.4 ↘ 10.2 *
 beste Teiler: 199.3 (20.), 333.1 (14.), 389.1 (19.)
 Trefferlage: 2.27 mm rechts, 0.37 mm hoch
 Streuwert: 4.80, horizontal: 5.18, vertikal: 4.40

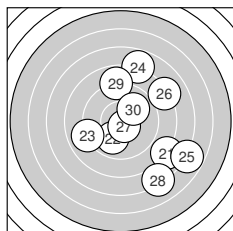

Serie 3:
 7.9 ↘ 9.9 ↙ 9.0 ← 7.8 ↑ 6.8 ↘
 8.1 ↗ 10.6 * 7.1 ↘ 8.9 ↑ 10.0 ↗
 beste Teiler: 85.4 (27.), 242.5 (30.), 254.5 (22.)
 Trefferlage: 2.51 mm rechts, 0.41 mm tief
 Streuwert: 4.56, horizontal: 4.17, vertikal: 4.92

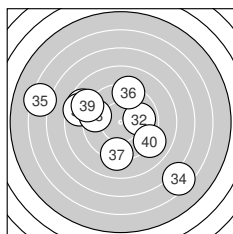

Serie 4:
 8.7 ↖ 9.9 → 8.6 ← 6.5 ↘ 6.3 ←
 9.3 ↑ 9.2 ↓ 9.5 ← 8.9 ↖ 9.0 ↘
 beste Teiler: 260.5 (32.), 362.6 (38.), 422.0 (36.)
 Trefferlage: 1.49 mm links, 0.00 mm
 Streuwert: 4.78, horizontal: 5.61, vertikal: 3.77



Ergebnis: **159.1** (151)
 Serien: 81.6 77.5
 Zähler: 2 7 5 1 2 0 0 3 0 0
 Innenzehner: 1
 Weitester: 1991 (6.), 1967 (14.), 1852 (17.)
 beste Teiler: 169.0 (4.), 207.4 (19.), 259.8 (11.)
 Trefferlage: 0.87 mm rechts, 0.55 mm hoch
 Streuwert: 6.81, horizontal: 8.29, vertikal: 4.89

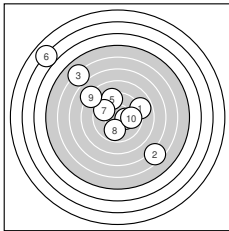
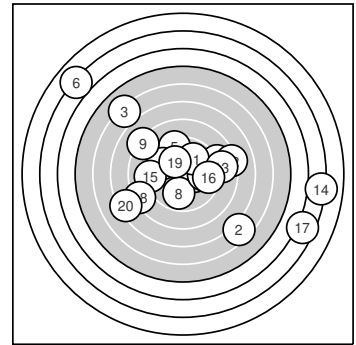

Serie 1:

8.9 →	6.5 ↘	6.1 ↖	10.3 *	9.3 ↑
3.0 ↙	9.7 ↖	9.9 ↓	8.1 ↖	9.8 →

beste Teiler: 169.0 (4.), 275.3 (8.), 289.1 (10.)
 Trefferlage: 1.63 mm links, 2.25 mm hoch
 Streuwert: 6.30, horizontal: 6.74, vertikal: 5.82

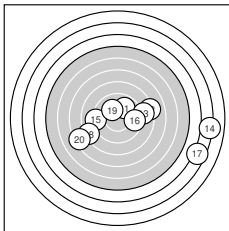

Serie 2:

9.9 ↗	8.1 →	8.7 →	3.1 →	9.1 ←
9.5 →	3.5 ↘	8.2 ↙	10.1 ↖	7.3 ↙

beste Teiler: 207.4 (19.), 259.8 (11.), 365.7 (16.)
 Trefferlage: 3.39 mm rechts, 1.13 mm tief
 Streuwert: 6.93, horizontal: 9.26, vertikal: 3.20



Ergebnis: **160.7** (151)
 Serien: 74.8 85.9
 Zähler: 2 3 5 5 4 1 0 0 0 0
 Innenzehner: 1
 Weitestе: 1272 (1.), 1148 (8.), 1112 (14.)
 beste Teiler: 192.2 (11.), 250.1 (19.), 318.7 (15.)
 Trefferlage: 0.17 mm rechts, 0.38 mm hoch
 Streuwert: 5.74, horizontal: 5.20, vertikal: 6.24

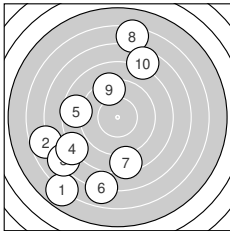
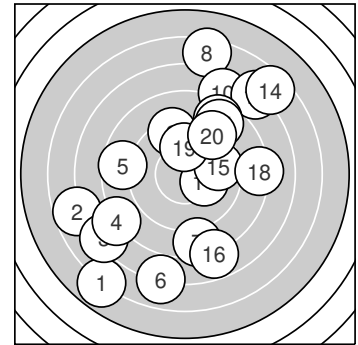

Serie 1:

5.9 ↙	6.7 ←	7.1 ↙	7.9 ↙	8.6 ←
6.9 ↓	8.4 ↓	6.4 ↑	9.3 ↑	7.6 ↑

beste Teiler: 409.3 (9.), 585.0 (5.), 641.3 (7.)
 Trefferlage: 3.41 mm links, 1.63 mm tief
 Streuwert: 6.13, horizontal: 4.70, vertikal: 7.28

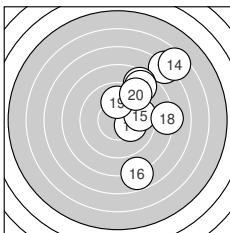

Serie 2:

10.2 *	7.0 ↗	8.6 ↗	6.5 ↗	9.7 →
7.8 ↓	8.7 ↗	8.2 →	10.0 ↑	9.2 ↗

beste Teiler: 192.2 (11.), 250.1 (19.), 318.7 (15.)
 Trefferlage: 3.76 mm rechts, 2.40 mm hoch
 Streuwert: 3.64, horizontal: 2.53, vertikal: 4.49



Ergebnis: **367.1** (345)
 Serien: 96.4 97.5 86.9 86.3
 Zähler: 6 21 7 4 2 0 0 0 0 0
 Innenzehner: 5
 Weitester: 1173 (38.), 1058 (27.), 833 (40.)
 beste Teiler: 43.1 (9.), 47.0 (11.), 131.7 (18.)
 Trefferlage: 0.31 mm rechts, 0.06 mm hoch
 Streuwert: 3.61, horizontal: 4.11, vertikal: 3.04

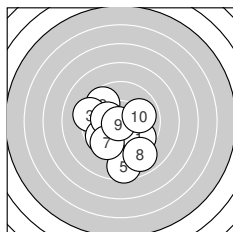
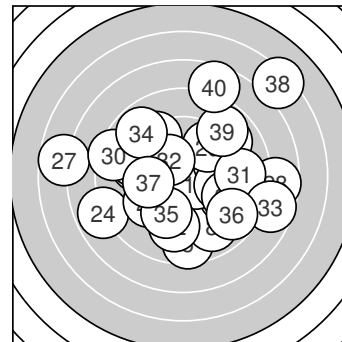

Serie 1:
 9.7 ↘ 9.6 ↘ 9.3 ← 9.7 ↗ 8.6 ↓
 10.3 * 9.6 ↙ 8.9 ↘ 10.8 * 9.9 →
 beste Teiler: 43.1 (9.), 175.5 (6.), 255.6 (10.)
 Trefferlage: 0.47 mm links, 1.33 mm tief
 Streuwert: 2.47, horizontal: 2.37, vertikal: 2.57

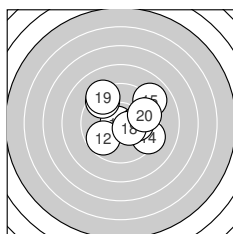

Serie 2:
 10.8 * 9.8 ↙ 9.8 → 9.3 ↘ 9.0 ↗
 10.1 → 9.4 ↘ 10.4 * 9.3 ↘ 9.6 →
 beste Teiler: 47.0 (11.), 131.7 (18.), 213.3 (16.)
 Trefferlage: 0.92 mm rechts, 0.61 mm hoch
 Streuwert: 2.29, horizontal: 2.58, vertikal: 1.96

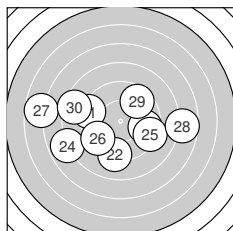

Serie 3:
 9.2 ← 9.2 ↓ 9.6 → 7.9 ↙ 9.2 →
 9.4 ↙ 6.7 ← 7.7 → 9.6 ↗ 8.4 ←
 beste Teiler: 332.0 (23.), 340.8 (29.), 376.4 (26.)
 Trefferlage: 1.41 mm links, 0.58 mm tief
 Streuwert: 4.41, horizontal: 5.78, vertikal: 2.35

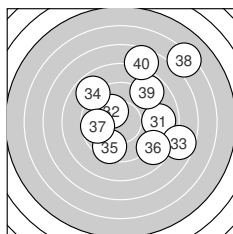

Serie 4:
 8.9 → 10.2 * 7.7 → 8.8 ↘ 9.5 ↙
 8.8 ↘ 9.7 ← 6.3 ↗ 8.8 ↗ 7.6 ↑
 beste Teiler: 186.5 (32.), 309.5 (37.), 353.5 (35.)
 Trefferlage: 2.23 mm rechts, 1.57 mm hoch
 Streuwert: 4.32, horizontal: 4.35, vertikal: 4.30



Ergebnis: **367.3** (348)
 Serien: 89.9 97.2 91.3 88.9
 Zähler: 10 17 6 5 2 0 0 0 0 0
 Innenzehner: 6
 Weitester: 1158 (7.), 1067 (21.), 894 (33.)
 beste Teiler: 58.2 (1.), 131.6 (10.), 156.2 (13.)
 Trefferlage: 0.67 mm links, 0.70 mm hoch
 Streuwert: 3.61, horizontal: 4.68, vertikal: 2.05

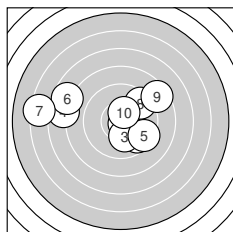
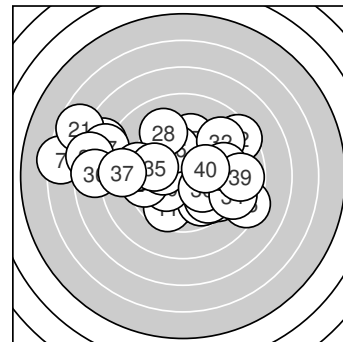

Serie 1:
 10.7 * 9.7 ↘ 10.1 ↓ 7.7 ← 9.4 ↗
 7.7 ↖ 6.3 ← 9.4 ↗ 8.5 ↗ 10.4 *
 beste Teiler: 58.2 (1.), 131.6 (10.), 214.7 (3.)
 Trefferlage: 1.20 mm links, 0.67 mm hoch
 Streuwert: 4.30, horizontal: 5.68, vertikal: 2.20

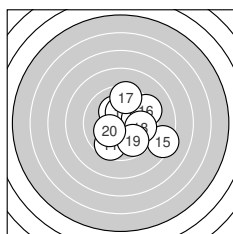

Serie 2:
 9.6 ↙ 10.2 * 10.3 * 10.0 → 8.4 ↗
 9.4 ↗ 9.5 ↑ 9.8 → 9.8 ↘ 10.2 *
 beste Teiler: 156.2 (13.), 182.9 (12.), 187.2 (20.)
 Trefferlage: 1.34 mm rechts, 0.03 mm tief
 Streuwert: 2.32, horizontal: 2.42, vertikal: 2.22

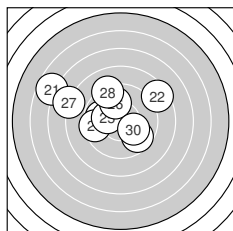

Serie 3:
 6.7 ↖ 8.4 ↗ 9.8 ← 9.5 ← 10.2 *
 9.9 ↑ 7.8 ← 9.2 ↖ 9.7 ↘ 10.1 ↗
 beste Teiler: 193.3 (25.), 214.5 (30.), 266.2 (26.)
 Trefferlage: 1.83 mm links, 1.45 mm hoch
 Streuwert: 3.54, horizontal: 4.43, vertikal: 2.33

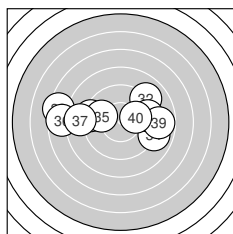

Serie 4:
 9.2 ← 9.0 ↗ 7.4 ← 8.9 ↗ 9.8 ←
 7.6 ← 8.7 ← 9.4 → 8.8 → 10.1 →
 beste Teiler: 222.9 (40.), 281.1 (35.), 392.4 (38.)
 Trefferlage: 1.00 mm links, 0.72 mm hoch
 Streuwert: 4.02, horizontal: 5.53, vertikal: 1.31



Ergebnis: **382.3** (363)
 Serien: 95.9 95.6 98.5 92.3
 Zähler: 12 21 5 2 0 0 0 0 0 0
 Innenzehner: 7
 Weitester: 798 (34.), 786 (33.), 732 (19.)
 beste Teiler: 74.5 (35.), 106.6 (26.), 130.9 (11.)
 Trefferlage: 0.20 mm rechts, 0.90 mm tief
 Streuwert: 2.72, horizontal: 3.36, vertikal: 1.86

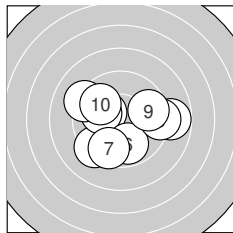
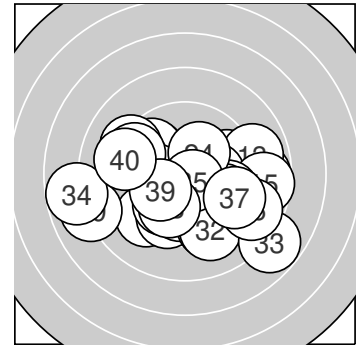

Serie 1:
 9.3 ↙ 10.3 * 10.1 ← 8.8 → 9.2 ↖
 9.8 ↓ 9.6 ↓ 9.2 → 9.7 → 9.9 ↗
 beste Teiler: 173.1 (2.), 221.4 (3.), 274.4 (10.)
 Trefferlage: 0.03 mm links, 0.28 mm tief
 Streuwert: 2.67, horizontal: 3.25, vertikal: 1.94

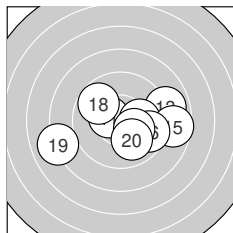

Serie 2:
 10.4 * 9.9 → 8.9 → 10.1 → 8.7 →
 9.6 → 10.2 * 9.8 ↖ 8.0 ← 10.0 ↓
 beste Teiler: 130.9 (11.), 176.1 (17.), 208.0 (14.)
 Trefferlage: 1.04 mm rechts, 0.46 mm tief
 Streuwert: 2.80, horizontal: 3.70, vertikal: 1.41

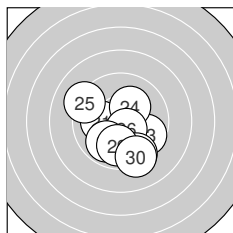

Serie 3:
 10.1 ← 10.3 * 9.7 ↘ 10.2 * 9.2 ↖
 10.5 * 9.4 ↓ 9.9 ↙ 9.9 ↓ 9.3 ↓
 beste Teiler: 106.6 (26.), 155.2 (22.), 186.9 (24.)
 Trefferlage: 0.00 mm , 1.25 mm tief
 Streuwert: 2.01, horizontal: 2.04, vertikal: 1.98

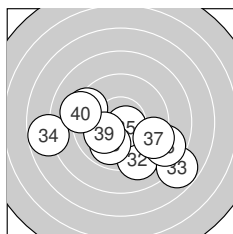

Serie 4:
 9.4 ↖ 9.2 ↓ 7.8 ↘ 7.8 ← 10.7 *
 8.8 → 9.4 → 9.9 ↓ 10.1 ↙ 9.2 ←
 beste Teiler: 74.5 (35.), 211.9 (39.), 262.9 (38.)
 Trefferlage: 0.18 mm links, 1.60 mm tief
 Streuwert: 3.44, horizontal: 4.42, vertikal: 2.01



Ergebnis: **393.1** (376)
 Serien: 100.8 97.1 95.9 99.3
 Zähler: 21 15 3 1 0 0 0 0 0 0
 Innenzehner: 13
 Weitester: 918 (15.), 683 (34.), 568 (26.)
 beste Teiler: 34.0 (4.), 48.7 (8.), 62.2 (14.)
 Trefferlage: 0.04 mm links, 0.12 mm tief
 Streuwert: 2.38, horizontal: 2.72, vertikal: 1.99

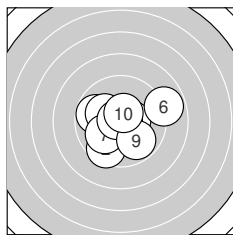
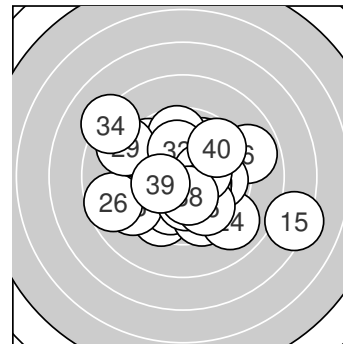

Serie 1:
 10.5 * 9.5 ↘ 9.8 ↖
 8.9 → 10.0 ↙ 10.8 *
 beste Teiler: 34.0 (4.), 48.7 (8.), 100.5 (10.)
 Trefferlage: 0.00 mm , 0.18 mm tief
 Streuwert: 1.95, horizontal: 2.29, vertikal: 1.54

10.8 * 10.1 ↖
 9.8 ↘ 10.6 *

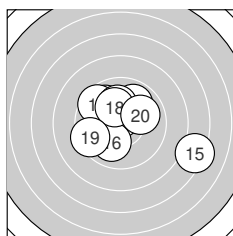

Serie 2:
 9.9 ↗ 9.9 ↘ 9.6 ↘
 10.0 ↘ 10.1 ↑ 10.2 *
 beste Teiler: 62.2 (14.), 195.2 (18.), 216.0 (17.)
 Trefferlage: 0.22 mm rechts, 0.48 mm hoch
 Streuwert: 2.82, horizontal: 3.39, vertikal: 2.11

10.7 * 7.3 →
 9.4 ↙ 10.0 →

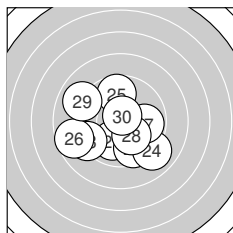

Serie 3:
 10.0 ↘ 9.6 ↘ 9.2 ↙
 8.7 ↖ 9.9 → 10.1 ↘
 beste Teiler: 66.4 (30.), 203.2 (28.), 242.0 (21.)
 Trefferlage: 0.57 mm links, 0.88 mm tief
 Streuwert: 2.69, horizontal: 3.06, vertikal: 2.25

9.0 ↘ 9.7 ↑
 9.0 ↖ 10.7 *

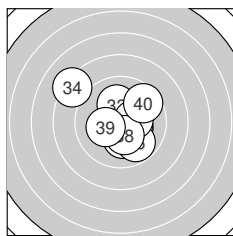

Serie 4:
 10.3 * 10.3 * 10.1 ↑
 9.8 ↘ 10.3 * 10.3 *
 beste Teiler: 151.6 (37.), 155.6 (38.), 156.6 (31.)
 Trefferlage: 0.16 mm rechts, 0.08 mm hoch
 Streuwert: 2.20, horizontal: 2.36, vertikal: 2.03

8.2 ↘ 10.2 *
 10.2 * 9.6 ↗



Ergebnis: **383.9** (366)
 Serien: 95.2 96.3 92.5 99.9
 Zähler: 13 21 5 1 0 0 0 0 0 0
 Innenzehner: 8
 Weitester: 953 (2.), 677 (27.), 615 (24.)
 beste Teiler: 58.4 (1.), 63.6 (32.), 76.8 (7.)
 Trefferlage: 2.07 mm rechts, 0.18 mm tief
 Streuwert: 2.30, horizontal: 2.61, vertikal: 1.95

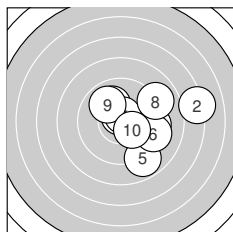
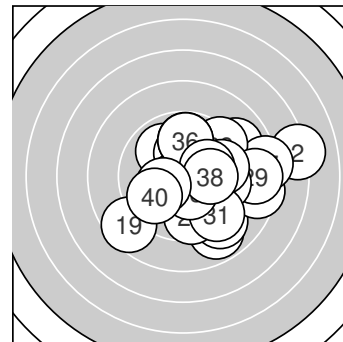

Serie 1:
 10.7 * 7.1 → 9.4 → 10.0 ↖ 8.9 ↘
 9.3 ↘ 10.6 * 9.0 ↗ 9.9 ↘ 10.3 *
 beste Teiler: 58.4 (1.), 76.8 (7.), 174.2 (10.)
 Trefferlage: 2.31 mm rechts, 0.23 mm hoch
 Streuwert: 2.77, horizontal: 3.27, vertikal: 2.17

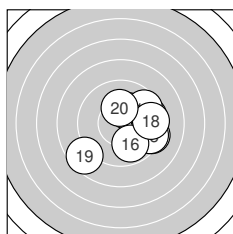

Serie 2:
 9.9 ↘ 10.3 * 9.6 → 9.3 ↘ 9.4 →
 9.9 ↘ 9.6 ↗ 9.5 → 8.6 ↙ 10.2 *
 beste Teiler: 170.4 (12.), 187.4 (20.), 251.8 (11.)
 Trefferlage: 1.67 mm rechts, 0.44 mm tief
 Streuwert: 2.28, horizontal: 2.53, vertikal: 2.00

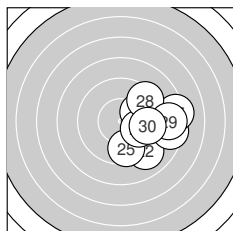

Serie 3:
 10.0 ↗ 9.1 ↘ 9.5 → 8.5 → 9.6 ↓
 10.0 ↘ 8.2 → 9.4 ↗ 8.6 → 9.6 →
 beste Teiler: 239.9 (26.), 243.7 (21.), 333.9 (30.)
 Trefferlage: 3.66 mm rechts, 0.53 mm tief
 Streuwert: 1.93, horizontal: 1.94, vertikal: 1.91

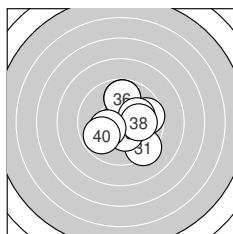

Serie 4:
 9.3 ↘ 10.7 * 10.4 * 9.7 → 9.8 ↑
 9.8 ↑ 10.1 → 10.1 → 10.2 * 9.8 ↙
 beste Teiler: 63.6 (32.), 141.0 (33.), 177.1 (39.)
 Trefferlage: 0.65 mm rechts, 0.02 mm hoch
 Streuwert: 1.87, horizontal: 1.84, vertikal: 1.89



Ergebnis: **394.3** (376)
 Serien: 96.9 97.8 99.9 99.7
 Zähler: 19 19 1 1 0 0 0 0 0 0
 Innenzehner: 13
 Weitester: 763 (3.), 579 (17.), 494 (13.)
 beste Teiler: 41.1 (18.), 68.2 (4.), 75.6 (9.)
 Trefferlage: 0.13 mm rechts, 0.11 mm hoch
 Streuwert: 2.22, horizontal: 2.48, vertikal: 1.92

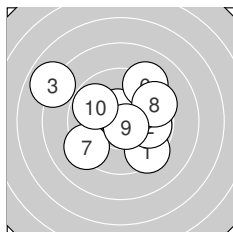
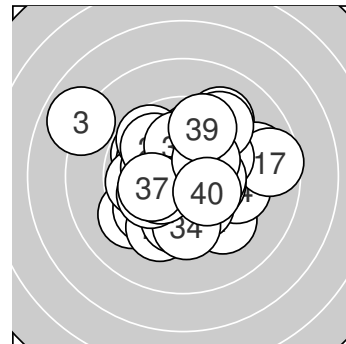

Serie 1:
 9.4 ↘ 9.8 → 7.9 ↖ 10.7 * 10.6 *
 9.2 ↗ 9.3 ↙ 9.5 ↗ 10.7 * 9.8 ↖
 beste Teiler: 68.2 (4.), 75.6 (9.), 99.6 (5.)
 Trefferlage: 0.05 mm links, 0.54 mm hoch
 Streuwert: 2.79, horizontal: 3.26, vertikal: 2.22

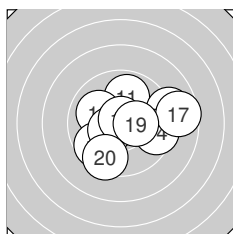

Serie 2:
 9.9 ↑ 10.0 ↖ 9.0 → 9.5 → 9.7 ↙
 10.5 * 8.6 → 10.8 * 10.3 * 9.5 ↙
 beste Teiler: 41.1 (18.), 119.5 (16.), 151.0 (19.)
 Trefferlage: 0.91 mm rechts, 0.08 mm tief
 Streuwert: 2.40, horizontal: 2.90, vertikal: 1.75

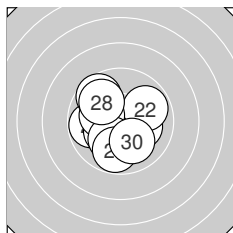

Serie 3:
 10.2 * 9.9 ↗ 9.8 ← 10.3 * 10.2 *
 9.7 ↖ 10.1 ↙ 9.9 ↖ 9.8 ↓ 10.0 ↘
 beste Teiler: 174.2 (24.), 194.5 (25.), 197.2 (21.)
 Trefferlage: 0.62 mm links, 0.23 mm tief
 Streuwert: 1.79, horizontal: 1.83, vertikal: 1.74

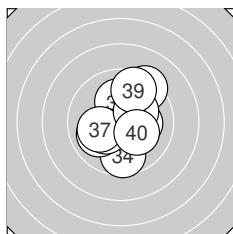

Serie 4:
 9.3 ↗ 10.2 * 10.1 ↑ 9.7 ↓ 10.0 ↙
 10.3 * 10.1 ← 10.2 * 9.6 ↑ 10.2 *
 beste Teiler: 171.5 (36.), 185.3 (38.), 188.9 (40.)
 Trefferlage: 0.29 mm rechts, 0.24 mm hoch
 Streuwert: 1.92, horizontal: 1.70, vertikal: 2.11



Ergebnis: **367.3** (350)
 Serien: 92.0 89.7 93.1 92.5
 Zähler: 12 11 12 5 0 0 0 0 0 0
 Innenzehner: 9
 Weitestе: 919 (1.), 884 (7.), 851 (6.)
 beste Teiler: 72.7 (36.), 90.6 (5.), 104.8 (31.)
 Trefferlage: 0.56 mm rechts, 0.31 mm tief
 Streuwert: 3.56, horizontal: 4.09, vertikal: 2.94

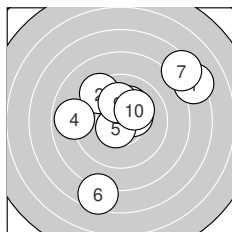
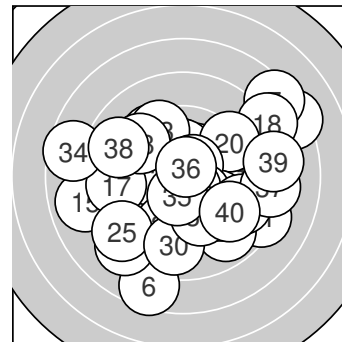

Serie 1:
 7.3 ↗ 9.4 ↘ 10.4 * 8.9 ← 10.6 *
 7.5 ↓ 7.4 ↗ 10.2 * 10.1 ↑ 10.2 *
 beste Teiler: 90.6 (5.), 146.8 (3.), 192.8 (8.)
 Trefferlage: 0.79 mm rechts, 0.99 mm hoch
 Streuwert: 3.92, horizontal: 4.09, vertikal: 3.73

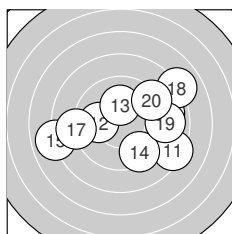

Serie 2:
 8.3 ↘ 10.0 ← 10.1 ↑ 9.4 ↘ 7.9 ←
 8.9 → 8.9 ← 8.0 ↗ 9.0 → 9.2 ↗
 beste Teiler: 201.0 (13.), 243.1 (12.), 381.9 (14.)
 Trefferlage: 1.28 mm rechts, 0.10 mm hoch
 Streuwert: 3.78, horizontal: 4.79, vertikal: 2.38

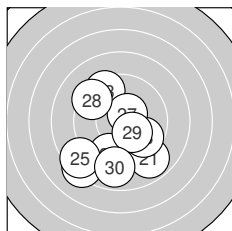

Serie 3:
 8.9 ↘ 8.3 ↗ 9.4 ↘ 9.4 ↓ 8.5 ↗
 9.7 ↘ 10.5 * 9.3 ↘ 10.2 * 8.9 ↓
 beste Teiler: 112.6 (27.), 180.3 (29.), 312.3 (26.)
 Trefferlage: 0.79 mm links, 1.84 mm tief
 Streuwert: 2.94, horizontal: 2.74, vertikal: 3.13

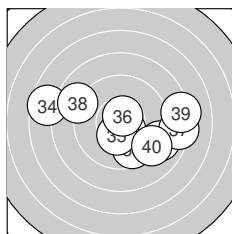

Serie 4:
 10.5 * 9.0 ↘ 9.7 ↓ 7.6 ← 10.4 *
 10.7 * 8.3 → 8.9 ↖ 8.2 → 9.2 ↘
 beste Teiler: 72.7 (36.), 104.8 (31.), 150.0 (35.)
 Trefferlage: 0.98 mm rechts, 0.50 mm tief
 Streuwert: 3.60, horizontal: 4.74, vertikal: 1.85



Ergebnis: **396.8** (380)
 Serien: 97.7 97.8 100.0 101.3
 Zähler: 21 18 1 0 0 0 0 0 0 0
 Innenzehner: 11
 Weitester: 506 (36.), 466 (5.), 466 (17.)
 beste Teiler: 30.1 (26.), 58.8 (38.), 80.4 (40.)
 Trefferlage: 0.21 mm links, 0.07 mm hoch
 Streuwert: 2.02, horizontal: 2.39, vertikal: 1.57

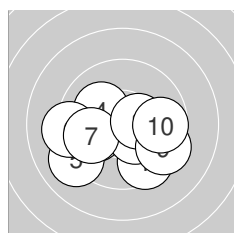
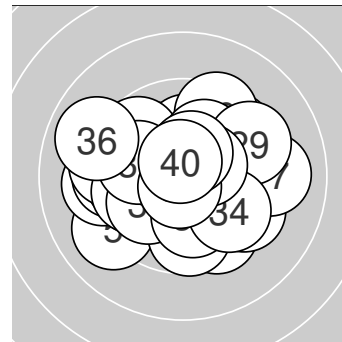

Serie 1:
 9.5 ↘ 10.0 ← 10.4 * 10.1 ↖ 9.1 ↙
 9.2 ← 9.9 ← 10.4 * 9.4 ↘ 9.7 →
 beste Teiler: 129.2 (8.), 142.1 (3.), 208.0 (4.)
 Trefferlage: 0.40 mm links, 0.94 mm tief
 Streuwert: 2.19, horizontal: 2.81, vertikal: 1.31

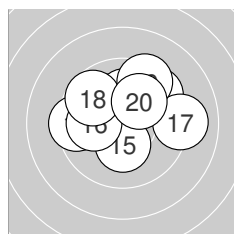

Serie 2:
 9.6 ↗ 9.5 ← 10.0 ↘ 10.1 ↑ 10.3 *
 10.0 ← 9.1 → 9.7 ↘ 9.4 ↗ 10.1 ↗
 beste Teiler: 171.0 (15.), 216.6 (14.), 221.2 (20.)
 Trefferlage: 0.06 mm rechts, 1.17 mm hoch
 Streuwert: 2.13, horizontal: 2.60, vertikal: 1.51

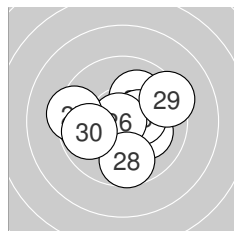

Serie 3:
 10.1 ↘ 9.8 ← 10.5 * 10.1 ↗ 10.4 *
 10.8 * 9.4 ← 9.7 ↓ 9.4 ↗ 9.8 ←
 beste Teiler: 30.1 (26.), 102.6 (23.), 136.1 (25.)
 Trefferlage: 0.08 mm links, 0.01 mm hoch
 Streuwert: 1.97, horizontal: 2.39, vertikal: 1.45

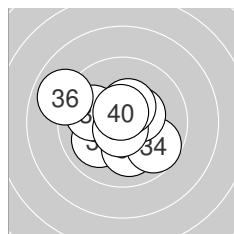

Serie 4:
 10.0 ↙ 10.1 ↓ 10.6 * 9.7 ↘ 9.9 ↖
 8.9 ↖ 10.4 * 10.7 * 10.4 * 10.6 *
 beste Teiler: 58.8 (38.), 80.4 (40.), 96.8 (33.)
 Trefferlage: 0.44 mm links, 0.04 mm hoch
 Streuwert: 1.76, horizontal: 2.03, vertikal: 1.43



Ergebnis: **399.1** (381)
 Serien: 98.9 98.8 99.9 101.5
 Zähler: 24 14 1 1 0 0 0 0 0 0
 Innenzehner: 16
 Weitester: 767 (7.), 580 (20.), 445 (17.)
 beste Teiler: 55.5 (6.), 59.6 (15.), 74.3 (22.)
 Trefferlage: 0.78 mm links, 0.48 mm hoch
 Streuwert: 1.90, horizontal: 1.81, vertikal: 1.98

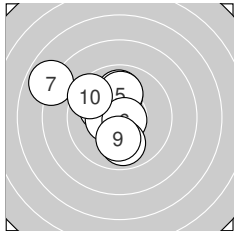
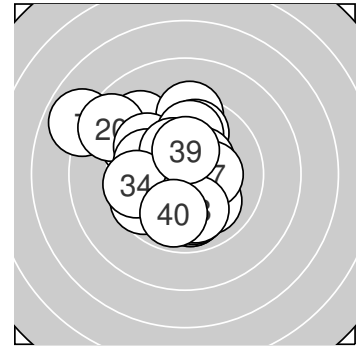

Serie 1:

10.0 ↑	10.2 *	10.1 ↑	10.5 *	10.0 ↑
10.7 *	7.9 ↖	9.9 ↓	10.1 ↓	9.5 ↖

beste Teiler: 55.5 (6.), 121.5 (4.), 199.9 (2.)
 Trefferlage: 1.20 mm links, 0.81 mm hoch
 Streuwert: 2.17, horizontal: 2.27, vertikal: 2.06

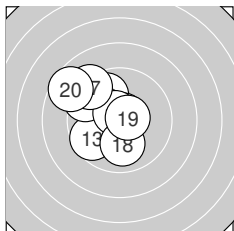

Serie 2:

10.4 *	9.8 ↘	9.6 ↙	9.3 ↘	10.7 *
10.6 *	9.2 ↘	10.0 ↓	10.6 *	8.6 ↖

beste Teiler: 59.6 (15.), 83.8 (16.), 84.7 (19.)
 Trefferlage: 1.55 mm links, 0.90 mm hoch
 Streuwert: 1.90, horizontal: 1.89, vertikal: 1.92

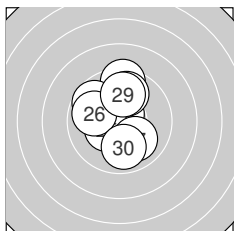

Serie 3:

9.4 ↑	10.7 *	10.2 *	9.7 ↖	10.4 *
9.9 ↖	10.0 ↘	9.8 ↑	9.9 ↑	9.9 ↓

beste Teiler: 74.3 (22.), 150.4 (25.), 188.5 (23.)
 Trefferlage: 0.34 mm links, 0.93 mm hoch
 Streuwert: 1.77, horizontal: 1.37, vertikal: 2.10

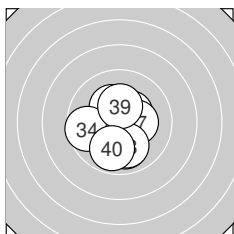

Serie 4:

10.3 *	10.0 ↓	10.3 *	9.6 ↖	10.4 *
10.4 *	10.3 *	10.0 ↓	10.3 *	9.9 ↓

beste Teiler: 140.5 (35.), 144.1 (36.), 157.2 (31.)
 Trefferlage: 0.01 mm links, 0.69 mm tief
 Streuwert: 1.50, horizontal: 1.37, vertikal: 1.62



Ergebnis: **373.5** (357)
 Serien: 93.8 93.7 93.8 92.2
 Zähler: 15 13 9 1 1 1 0 0 0 0
 Innenzehner: 10
 Weitester: 1272 (19.), 1239 (10.), 772 (31.)
 beste Teiler: 63.0 (14.), 83.1 (3.), 93.4 (26.)
 Trefferlage: 0.54 mm rechts, 0.68 mm tief
 Streuwert: 3.46, horizontal: 3.84, vertikal: 3.02

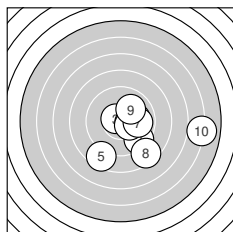
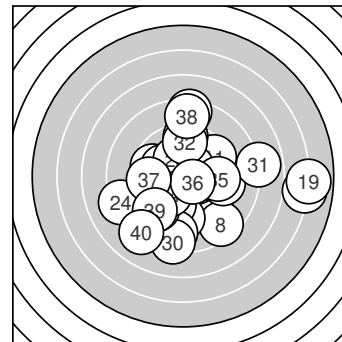

Serie 1:
 10.1 → 9.4 ↘ 10.6 * 10.4 * 8.5 ↙
 10.4 * 9.9 → 8.5 ↘ 10.0 ↗ 6.0 →
 beste Teiler: 83.1 (3.), 139.1 (4.), 145.4 (6.)
 Trefferlage: 2.43 mm rechts, 1.26 mm tief
 Streuwert: 3.26, horizontal: 3.97, vertikal: 2.35

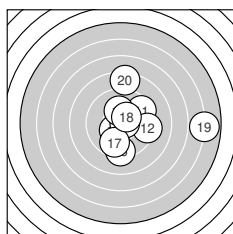

Serie 2:
 9.5 ↗ 9.3 → 10.4 * 10.7 * 10.2 *
 9.3 ↓ 9.7 ↓ 10.4 * 5.9 → 8.3 ↑
 beste Teiler: 63.0 (14.), 128.0 (18.), 142.8 (13.)
 Trefferlage: 1.99 mm rechts, 0.18 mm hoch
 Streuwert: 3.58, horizontal: 4.11, vertikal: 2.95

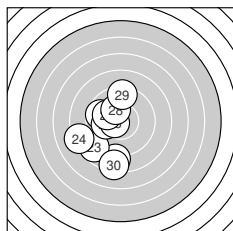

Serie 3:
 9.7 ↖ 8.6 ↓ 8.7 ↙ 8.2 ↖ 10.1 ←
 10.6 * 10.1 ↖ 10.2 * 9.3 ↑ 8.3 ↓
 beste Teiler: 93.4 (26.), 190.3 (28.), 225.0 (27.)
 Trefferlage: 2.08 mm links, 1.19 mm tief
 Streuwert: 2.79, horizontal: 1.94, vertikal: 3.44

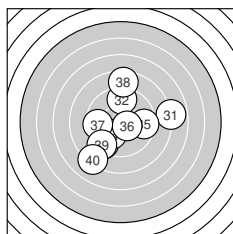

Serie 4:
 7.9 → 9.6 ↑ 9.3 ↙ 10.0 ↙ 9.5 →
 10.5 * 9.6 ← 8.5 ↑ 9.2 ↙ 8.1 ↙
 beste Teiler: 113.3 (36.), 227.0 (34.), 345.5 (32.)
 Trefferlage: 0.16 mm links, 0.47 mm tief
 Streuwert: 3.53, horizontal: 3.62, vertikal: 3.44



Ergebnis: **388.2** (368)
 Serien: 97.4 97.5 96.8 96.5
 Zähler: 13 22 5 0 0 0 0 0 0 0
 Innenzehner: 7
 Weitester: 634 (32.), 600 (29.), 565 (31.)
 beste Teiler: 7.0 (1.), 36.7 (37.), 47.0 (19.)
 Trefferlage: 1.22 mm rechts, 0.15 mm tief
 Streuwert: 2.31, horizontal: 2.61, vertikal: 1.97

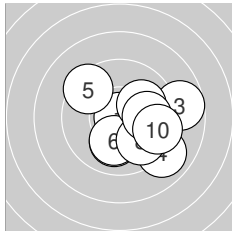
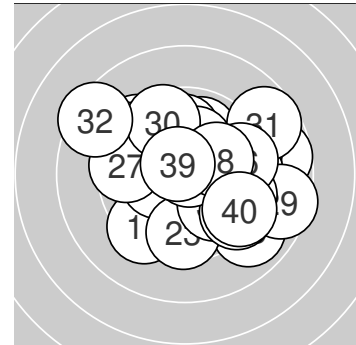

Serie 1:

10.9 *	10.0 ↓	8.7 →	9.0 ↘	9.4 ↖
10.1 ↓	10.0 ↗	9.8 ↘	10.0 →	9.5 →

beste Teiler: 7.0 (1.), 215.8 (6.), 227.3 (2.)
 Trefferlage: 1.51 mm rechts, 0.58 mm tief
 Streuwert: 2.19, horizontal: 2.48, vertikal: 1.84

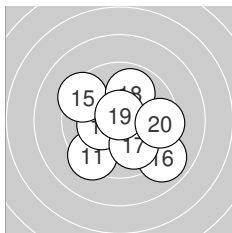

Serie 2:

9.4 ↙	10.3 *	9.4 ↘	10.0 ↘	9.4 ↖
8.9 ↘	9.9 ↘	9.9 ↑	10.8 *	9.5 →

beste Teiler: 47.0 (19.), 168.5 (12.), 230.2 (14.)
 Trefferlage: 0.73 mm rechts, 0.79 mm tief
 Streuwert: 2.30, horizontal: 2.55, vertikal: 2.03

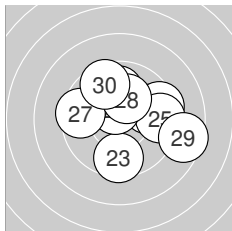

Serie 3:

9.9 ↑	9.9 →	9.6 ↓	9.4 →	9.5 →
10.6 *	9.5 ←	10.2 *	8.6 →	9.6 ↖

beste Teiler: 94.9 (26.), 195.7 (28.), 259.3 (21.)
 Trefferlage: 1.07 mm rechts, 0.60 mm hoch
 Streuwert: 2.41, horizontal: 2.78, vertikal: 1.96

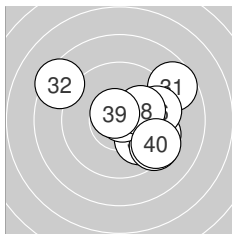

Serie 4:

8.7 ↗	8.4 ↖	9.9 ↘	9.4 ↘	9.5 →
9.6 →	10.8 *	10.1 →	10.7 *	9.4 ↘

beste Teiler: 36.7 (37.), 75.2 (39.), 209.3 (38.)
 Trefferlage: 1.59 mm rechts, 0.14 mm hoch
 Streuwert: 2.51, horizontal: 2.92, vertikal: 2.01



Ergebnis: 361.1 (342)
Serien: 88.4 92.4 91.3 89.0
Zähler: 7 14 14 4 1 0 0 0 0 0
Innenzehner: 6
Weiteste: 1137 (7.), 944 (1.), 875 (24.)
beste Teiler: 109.6 (5.), 114.6 (10.), 118.0 (25.)
Trefferlage: 0.40 mm links, 0.37 mm tief
Streuwert: 3.82, horizontal: 4.80, vertikal: 2.48

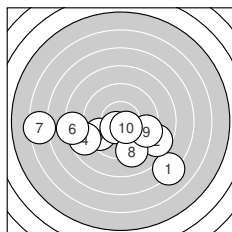
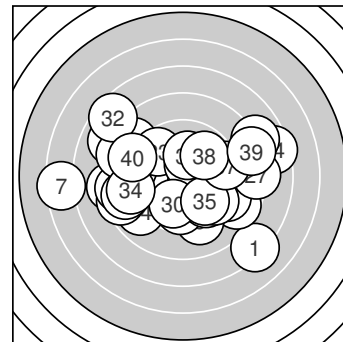

Serie 1:

7.2 ↘	8.7 ↘	9.6 ↙	8.7 ↙	10.5 *
8.2 ←	6.4 ←	9.2 ↓	9.4 →	10.5 *

beste Teiler: 109.6 (5.), 114.6 (10.), 342.3 (3.)
Trefferlage: 0.89 mm links, 2.27 mm tief
Streuwert: 4.20, horizontal: 5.63, vertikal: 1.87

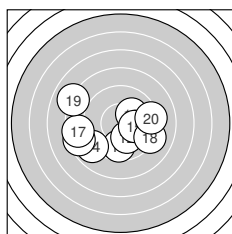

Serie 2:

9.7 ↓	10.1 ↓	10.2 *	8.9 ↙	10.2 *
8.5 ←	8.5 ←	9.1 →	8.0 ↖	9.2 →

beste Teiler: 200.1 (15.), 200.8 (13.), 214.4 (12.)
Trefferlage: 0.98 mm links, 0.89 mm tief
Streuwert: 3.34, horizontal: 4.22, vertikal: 2.11

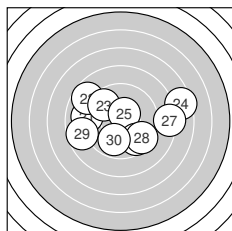

Serie 3:

9.1 ←	8.7 ↘	9.6 ↘	7.5 →	10.5 *
9.6 ↘	8.2 →	9.5 ↘	8.7 ↙	9.9 ↓

beste Teiler: 118.0 (25.), 272.6 (30.), 326.0 (23.)
Trefferlage: 0.29 mm rechts, 0.05 mm hoch
Streuwert: 3.75, horizontal: 4.81, vertikal: 2.22

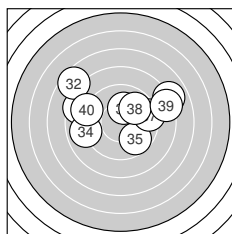

Serie 4:

8.5 ↖	7.6 ↘	7.9 ↗	8.9 ↙	9.7 ↘
10.2 *	9.3 →	9.8 ↗	8.2 →	8.9 ↖

beste Teiler: 198.4 (36.), 277.9 (38.), 308.8 (35.)
Trefferlage: 0.03 mm links, 1.62 mm hoch
Streuwert: 3.91, horizontal: 5.08, vertikal: 2.19



Ergebnis: **365.7** (343)
 Serien: 94.6 88.4 94.5 88.2
 Zähler: 5 19 12 2 2 0 0 0 0 0
 Innenzehner: 3
 Weitester: 1183 (16.), 1008 (35.), 853 (32.)
 beste Teiler: 54.4 (38.), 121.7 (22.), 178.7 (12.)
 Trefferlage: 0.55 mm links, 0.65 mm tief
 Streuwert: 3.59, horizontal: 3.66, vertikal: 3.51

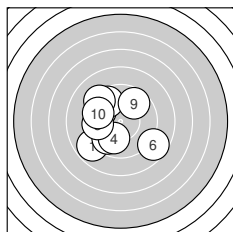
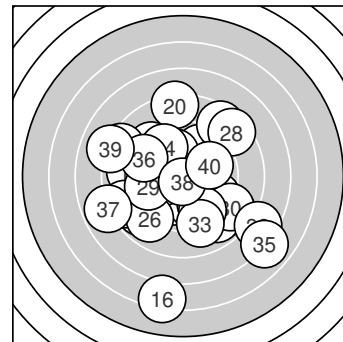

Serie 1:

8.8 ↙	9.7 ↙	9.7 ↖	9.9 ↓	9.6 ←
8.7 ↘	9.6 ↘	9.3 ↘	9.7 ↗	9.6 ↘

beste Teiler: 258.1 (4.), 306.4 (2.), 318.9 (3.)
 Trefferlage: 1.44 mm links, 0.12 mm tief
 Streuwert: 2.66, horizontal: 2.72, vertikal: 2.59

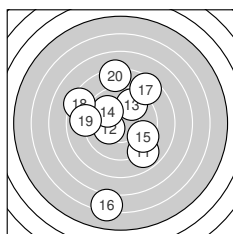

Serie 2:

8.9 ↘	10.2 *	9.7 ↗	9.9 ↘	9.5 ↘
6.2 ↓	8.5 ↗	8.4 ↖	8.9 ←	8.2 ↑

beste Teiler: 178.7 (12.), 252.0 (14.), 309.8 (13.)
 Trefferlage: 0.55 mm links, 0.08 mm hoch
 Streuwert: 4.39, horizontal: 3.38, vertikal: 5.21

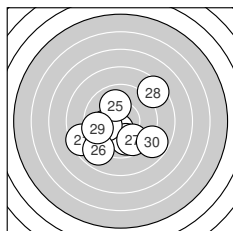

Serie 3:

8.5 ↙	10.5 *	9.9 ↓	10.1 ←	10.0 ↑
8.9 ↙	9.7 ↘	8.5 ↗	9.6 ←	8.8 ↘

beste Teiler: 121.7 (22.), 212.9 (24.), 235.2 (25.)
 Trefferlage: 0.36 mm links, 1.11 mm tief
 Streuwert: 2.97, horizontal: 3.35, vertikal: 2.54

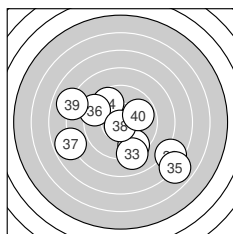

Serie 4:

9.4 ↘	7.5 ↘	9.0 ↓	9.7 ↘	6.9 ↘
9.3 ↖	7.8 ←	10.7 *	8.0 ↖	9.9 ↗

beste Teiler: 54.4 (38.), 272.2 (40.), 324.7 (34.)
 Trefferlage: 0.13 mm rechts, 1.45 mm tief
 Streuwert: 4.35, horizontal: 5.15, vertikal: 3.36



Ergebnis: **400.1** (385)
 Serien: 98.4 100.7 101.4 99.6
 Zähler: 26 13 1 0 0 0 0 0 0 0
 Innenzehner: 19
 Weitestе: 518 (15.), 441 (17.), 441 (37.)
 beste Teiler: 55.1 (26.), 70.2 (31.), 71.7 (13.)
 Trefferlage: 0.13 mm links, 0.23 mm hoch
 Streuwert: 1.90, horizontal: 2.28, vertikal: 1.43

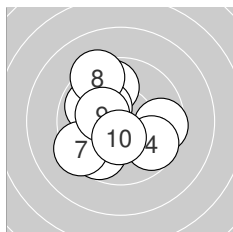
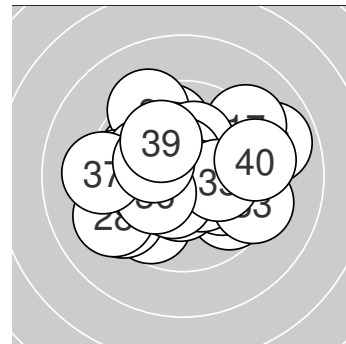

Serie 1:
 9.6 → 9.7 ↙ 9.8 ↑ 9.7 ↘ 10.3 *
 9.9 ↖ 9.4 ↗ 9.3 ↗ 10.3 * 10.4 *
 beste Teiler: 133.6 (10.), 159.7 (9.), 171.5 (5.)
 Trefferlage: 0.70 mm links, 0.10 mm hoch
 Streuwert: 2.12, horizontal: 2.11, vertikal: 2.13

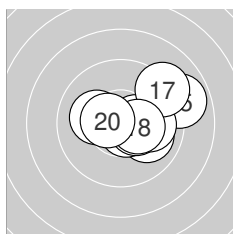

Serie 2:
 10.5 * 10.0 ↘ 10.7 * 10.4 * 8.9 →
 10.0 → 9.2 ↗ 10.4 * 10.1 ← 10.5 *
 beste Teiler: 71.7 (13.), 110.2 (20.), 125.3 (11.)
 Trefferlage: 1.41 mm rechts, 0.30 mm hoch
 Streuwert: 1.63, horizontal: 2.00, vertikal: 1.15

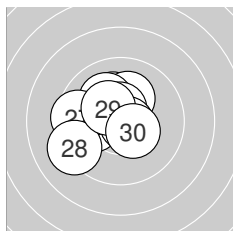

Serie 3:
 10.2 * 10.1 ← 10.2 * 10.1 ↖ 10.6 *
 10.7 * 9.5 ← 9.2 ↗ 10.4 * 10.4 *
 beste Teiler: 55.1 (26.), 98.3 (25.), 130.2 (30.)
 Trefferlage: 1.03 mm links, 0.43 mm hoch
 Streuwert: 1.52, horizontal: 1.69, vertikal: 1.32

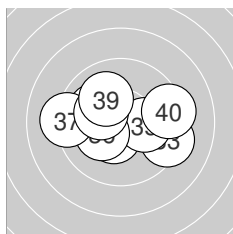

Serie 4:
 10.7 * 10.4 * 9.3 ↘ 10.0 ↖ 10.2 *
 10.2 * 9.2 ← 10.2 * 10.1 ↖ 9.3 →
 beste Teiler: 70.2 (31.), 130.1 (32.), 178.1 (36.)
 Trefferlage: 0.22 mm links, 0.11 mm hoch
 Streuwert: 2.04, horizontal: 2.68, vertikal: 1.07



Ergebnis: **355.0** (339)
 Serien: 94.9 89.4 88.5 82.2
 Zähler: 6 14 14 5 1 0 0 0 0 0
 Innenzehner: 4
 Weitestе: 1137 (19.), 975 (21.), 921 (38.)
 beste Teiler: 66.0 (23.), 102.8 (6.), 129.0 (5.)
 Trefferlage: 0.48 mm rechts, 0.03 mm hoch
 Streuwert: 4.08, horizontal: 4.76, vertikal: 3.27

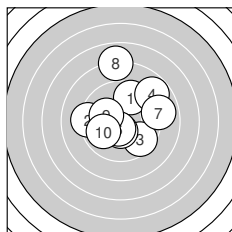
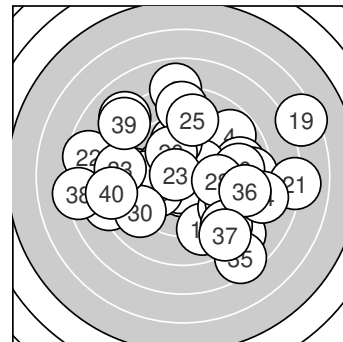

Serie 1:
 9.6 ↗ 9.2 ← 9.6 ↘ 8.8 ↗ 10.4 *
 10.5 * 8.9 → 7.9 ↑ 10.1 ↖ 9.9 ↙
 beste Teiler: 102.8 (6.), 129.0 (5.), 201.3 (9.)
 Trefferlage: 0.36 mm rechts, 1.03 mm hoch
 Streuwert: 2.94, horizontal: 2.89, vertikal: 2.98

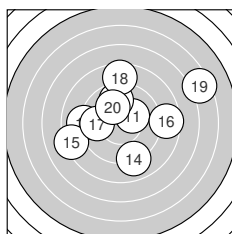

Serie 2:
 10.2 * 9.7 ↑ 9.0 ← 9.0 ↓ 8.2 ←
 8.6 → 9.7 ← 8.6 ↑ 6.4 ↗ 10.0 ↘
 beste Teiler: 179.2 (11.), 232.5 (20.), 305.5 (12.)
 Trefferlage: 0.34 mm rechts, 1.01 mm hoch
 Streuwert: 4.16, horizontal: 4.95, vertikal: 3.18

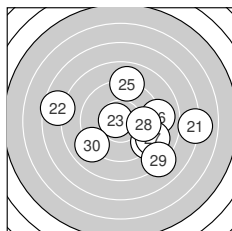

Serie 3:
 7.1 → 7.6 ← 10.7 * 9.2 ↘ 9.0 ↑
 9.0 → 9.1 ↘ 9.7 → 8.1 ↘ 9.0 ↙
 beste Teiler: 66.0 (23.), 303.3 (28.), 446.0 (24.)
 Trefferlage: 1.85 mm rechts, 0.67 mm tief
 Streuwert: 4.08, horizontal: 5.05, vertikal: 2.78

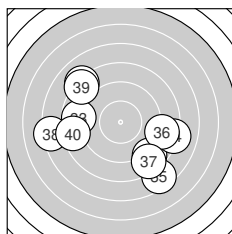

Serie 4:
 8.7 ↘ 8.1 ↘ 8.8 ← 8.1 → 7.5 ↘
 8.7 → 8.4 ↘ 7.3 ← 8.2 ↘ 8.4 ←
 beste Teiler: 548.4 (33.), 553.7 (36.), 573.3 (31.)
 Trefferlage: 0.61 mm links, 1.23 mm tief
 Streuwert: 5.08, horizontal: 6.04, vertikal: 3.89



Ergebnis: **389.8** (372)
 Serien: 94.2 98.2 98.9 98.5
 Zähler: 18 17 4 1 0 0 0 0 0 0
 Innenzehner: 13
 Weitester: 944 (5.), 698 (2.), 597 (24.)
 beste Teiler: 26.9 (4.), 40.0 (13.), 85.1 (19.)
 Trefferlage: 0.13 mm links, 0.39 mm hoch
 Streuwert: 2.52, horizontal: 2.81, vertikal: 2.19

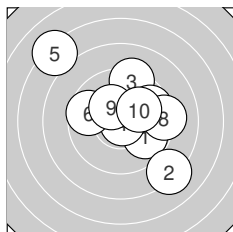
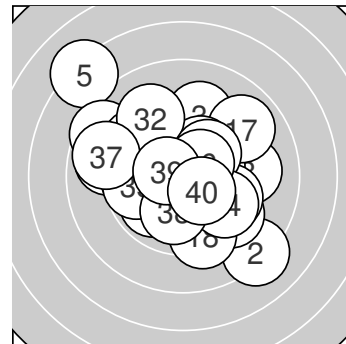

Serie 1:
 9.8 ↘ 8.2 ↘ 9.3 ↑ 10.8 * 7.2 ↘
 9.6 ← 9.7 → 9.2 → 10.3 * 10.1 ↗
 beste Teiler: 26.9 (4.), 167.5 (9.), 217.5 (10.)
 Trefferlage: 0.70 mm rechts, 0.92 mm hoch
 Streuwert: 3.32, horizontal: 3.50, vertikal: 3.12

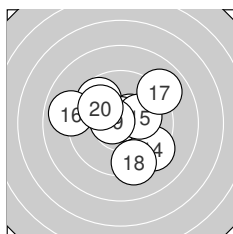

Serie 2:
 9.7 ↘ 10.5 * 10.8 * 9.3 ↘ 10.2 *
 8.9 ← 9.0 ↗ 9.3 ↓ 10.6 * 9.9 ↘
 beste Teiler: 40.0 (13.), 85.1 (19.), 113.4 (12.)
 Trefferlage: 0.12 mm rechts, 0.34 mm hoch
 Streuwert: 2.41, horizontal: 2.68, vertikal: 2.11

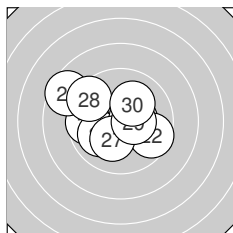

Serie 3:
 10.4 * 9.6 ↘ 9.7 ← 8.6 ↘ 10.0 ↗
 10.5 * 10.2 * 9.4 ↘ 10.4 * 10.1 ↗
 beste Teiler: 112.2 (26.), 131.1 (29.), 145.2 (21.)
 Trefferlage: 0.64 mm links, 0.25 mm hoch
 Streuwert: 2.20, horizontal: 2.68, vertikal: 1.56

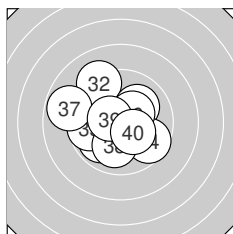

Serie 4:
 9.9 ↗ 9.2 ↘ 10.1 ↗ 9.6 ↘ 9.7 ←
 10.4 * 8.8 ← 10.0 ↓ 10.5 * 10.3 *
 beste Teiler: 112.5 (39.), 143.8 (36.), 158.0 (40.)
 Trefferlage: 0.71 mm links, 0.04 mm hoch
 Streuwert: 2.20, horizontal: 2.44, vertikal: 1.92



Ergebnis: **374.7** (353)
 Serien: 92.6 93.8 93.5 94.8
 Zähler: 10 15 14 0 1 0 0 0 0 0
 Innenzehner: 8
 Weitester: 1026 (5.), 716 (28.), 666 (26.)
 beste Teiler: 32.2 (14.), 79.4 (40.), 89.6 (20.)
 Trefferlage: 0.26 mm links, 0.27 mm tief
 Streuwert: 3.21, horizontal: 3.83, vertikal: 2.44

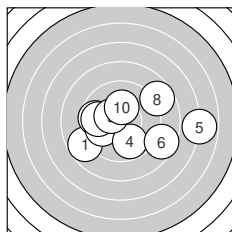
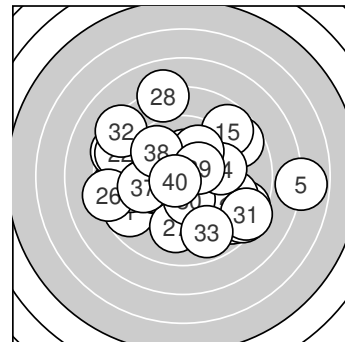

Serie 1:
 8.8 ↙ 9.6 ← 9.9 ↙ 9.8 ↓ 6.8 →
 8.6 ↘ 9.8 ← 8.7 ↗ 10.4 * 10.2 *
 beste Teiler: 139.1 (9.), 181.5 (10.), 256.8 (3.)
 Trefferlage: 0.72 mm rechts, 0.38 mm tief
 Streuwert: 3.61, horizontal: 4.71, vertikal: 1.99

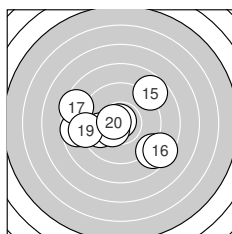

Serie 2:
 9.8 ↙ 8.7 ← 8.7 ↘ 10.8 * 8.7 ↗
 8.5 ↘ 8.5 ← 10.4 * 9.1 ← 10.6 *
 beste Teiler: 32.2 (14.), 89.6 (20.), 135.0 (18.)
 Trefferlage: 0.75 mm links, 0.40 mm tief
 Streuwert: 3.29, horizontal: 4.05, vertikal: 2.28

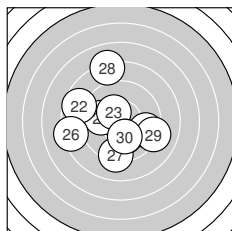

Serie 3:
 9.9 ↙ 8.7 ↖ 10.4 * 10.1 ↓ 9.6 →
 8.3 ↙ 9.2 ↓ 8.1 ↑ 9.1 ↘ 10.1 ↓
 beste Teiler: 146.4 (23.), 207.1 (30.), 209.0 (24.)
 Trefferlage: 0.89 mm links, 0.23 mm tief
 Streuwert: 3.25, horizontal: 3.38, vertikal: 3.12

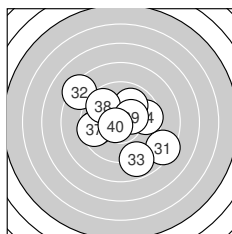

Serie 4:
 8.4 ↘ 8.3 ↖ 8.9 ↓ 9.6 → 9.6 ←
 9.9 ↗ 9.5 ← 9.7 ↖ 10.3 * 10.6 *
 beste Teiler: 79.4 (40.), 152.5 (39.), 252.1 (36.)
 Trefferlage: 0.14 mm links, 0.06 mm tief
 Streuwert: 3.03, horizontal: 3.41, vertikal: 2.60



Ergebnis: **389.8** (371)
 Serien: 96.1 97.4 99.8 96.5
 Zähler: 17 19 2 2 0 0 0 0 0 0
 Innenzehner: 12
 Weitester: 816 (18.), 791 (4.), 719 (2.)
 beste Teiler: 80.5 (8.), 113.8 (23.), 115.5 (10.)
 Trefferlage: 1.03 mm links, 0.51 mm tief
 Streuwert: 2.35, horizontal: 2.71, vertikal: 1.91

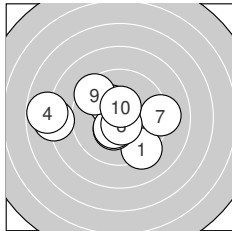
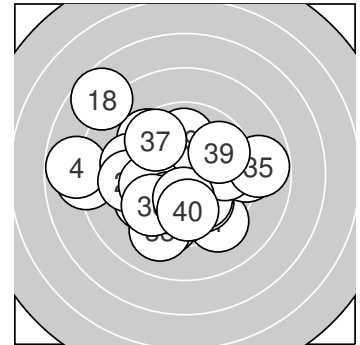

Serie 1:
 9.3 ↘ 8.1 ← 10.3 * 7.8 ← 10.4 *
 10.4 * 9.2 → 10.6 * 9.5 ↘ 10.5 *
 beste Teiler: 80.5 (8.), 115.5 (10.), 132.4 (6.)
 Trefferlage: 1.29 mm links, 0.13 mm tief
 Streuwert: 2.96, horizontal: 3.84, vertikal: 1.66

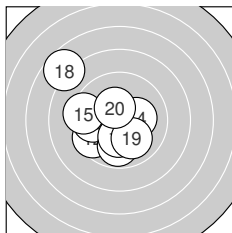

Serie 2:
 10.3 * 9.6 ↙ 9.8 ← 10.2 * 9.4 ←
 9.8 ↓ 10.2 * 7.7 ↘ 10.0 ↘ 10.4 *
 beste Teiler: 145.6 (20.), 166.0 (11.), 181.4 (17.)
 Trefferlage: 1.51 mm links, 0.07 mm tief
 Streuwert: 2.42, horizontal: 2.46, vertikal: 2.38

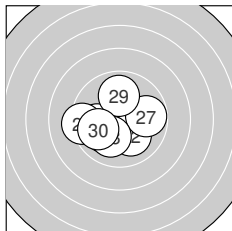

Serie 3:
 10.2 * 10.1 ↘ 10.5 * 9.9 ← 9.3 ←
 10.1 ↙ 9.8 → 10.1 ↙ 9.9 ↑ 9.9 ←
 beste Teiler: 113.8 (23.), 179.7 (21.), 213.7 (28.)
 Trefferlage: 0.99 mm links, 0.59 mm tief
 Streuwert: 1.67, horizontal: 1.97, vertikal: 1.30

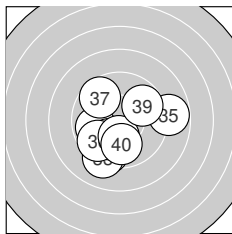

Serie 4:
 9.9 ← 9.4 ↓ 9.2 ↓ 10.0 ↓ 8.8 →
 9.6 ↙ 9.6 ↘ 10.3 * 9.8 ↗ 9.9 ↓
 beste Teiler: 175.2 (38.), 239.1 (34.), 262.8 (40.)
 Trefferlage: 0.34 mm links, 1.25 mm tief
 Streuwert: 2.36, horizontal: 2.52, vertikal: 2.18



Ergebnis: **340.9** (326)
 Serien: 74.3 84.3 88.5 93.8
 Zähler: 6 12 10 7 4 1 0 0 0 0
 Innenzehner: 3
 Weitestе: 1295 (3.), 1217 (5.), 1182 (2.)
 beste Teiler: 95.5 (21.), 117.7 (37.), 154.7 (27.)
 Trefferlage: 0.35 mm links, 0.92 mm hoch
 Streuwert: 4.86, horizontal: 5.18, vertikal: 4.52

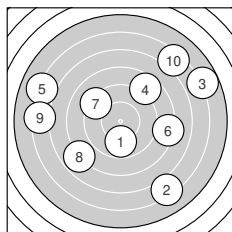
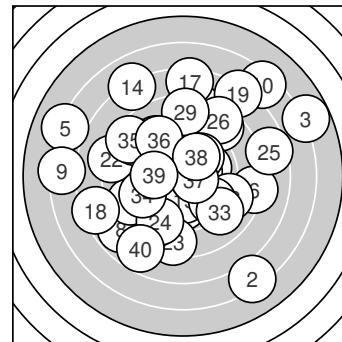

Serie 1:
 9.8 ↓ 6.2 ↘ 5.8 ↗ 8.6 ↗ 6.1 ↖
 8.2 → 9.2 ↙ 7.8 ↘ 6.3 ← 6.3 ↗
 beste Teiler: 289.0 (1.), 436.8 (7.), 583.6 (4.)
 Trefferlage: 0.40 mm rechts, 0.75 mm hoch
 Streuwert: 7.02, horizontal: 8.19, vertikal: 5.60

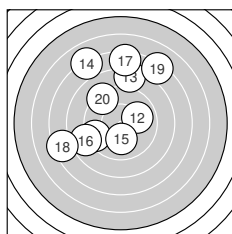

Serie 2:
 9.3 ↙ 9.9 → 8.2 ↑ 7.0 ↘ 10.1 ↓
 8.7 ↙ 7.3 ↑ 7.4 ↙ 7.2 ↗ 9.2 ↘
 beste Teiler: 225.3 (15.), 252.3 (12.), 408.7 (11.)
 Trefferlage: 1.47 mm links, 2.66 mm hoch
 Streuwert: 4.59, horizontal: 4.11, vertikal: 5.03

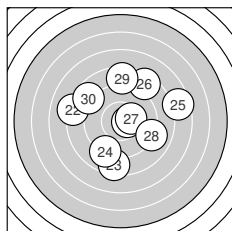

Serie 3:
 10.6 * 8.1 ↖ 8.4 ↓ 9.0 ↙ 7.5 →
 8.4 ↗ 10.3 * 9.0 → 8.5 ↑ 8.7 ↘
 beste Teiler: 95.5 (21.), 154.7 (27.), 484.7 (24.)
 Trefferlage: 0.41 mm rechts, 0.64 mm hoch
 Streuwert: 4.20, horizontal: 4.40, vertikal: 3.98

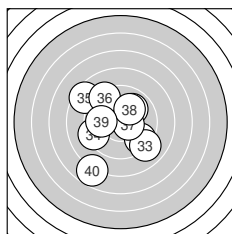

Serie 4:
 9.5 ↘ 10.0 ↗ 9.0 ↘ 9.3 ↙ 8.5 ↖
 9.3 ↘ 10.5 * 10.1 ↗ 9.8 ← 7.8 ↙
 beste Teiler: 117.7 (37.), 224.9 (38.), 249.9 (32.)
 Trefferlage: 0.76 mm links, 0.38 mm tief
 Streuwert: 3.23, horizontal: 3.17, vertikal: 3.29



Ergebnis: **388.5** (371)
 Serien: 96.9 97.0 97.0 97.6
 Zähler: 16 19 5 0 0 0 0 0 0 0
 Innenzehner: 12
 Weitester: 660 (26.), 613 (37.), 539 (17.)
 beste Teiler: 38.2 (19.), 63.1 (5.), 85.7 (33.)
 Trefferlage: 0.06 mm rechts, 0.64 mm tief
 Streuwert: 2.42, horizontal: 2.83, vertikal: 1.92

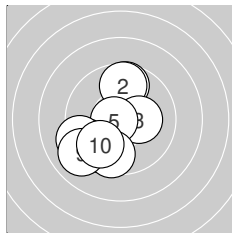
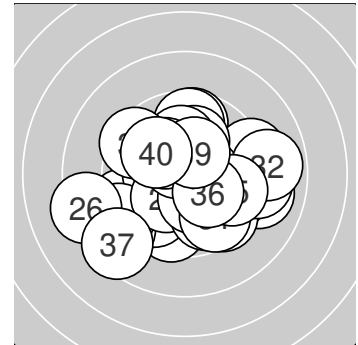

Serie 1:

9.7 ↑	9.7 ↑	10.3 *	9.6 ↙	10.7 *
9.4 ↙	9.6 ↓	9.2 ↙	9.0 ↙	9.7 ↙

beste Teiler: 63.1 (5.), 173.0 (3.), 305.6 (10.)
 Trefferlage: 1.37 mm links, 0.94 mm tief
 Streuwert: 2.19, horizontal: 1.89, vertikal: 2.45

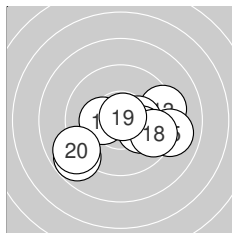

Serie 2:

10.3 *	9.9 ↘	9.3 →	10.3 *	9.0 →
10.1 ↘	8.8 ↙	9.6 ↘	10.8 *	8.9 ↙

beste Teiler: 38.2 (19.), 162.0 (14.), 169.0 (11.)
 Trefferlage: 0.81 mm rechts, 0.90 mm tief
 Streuwert: 2.46, horizontal: 3.18, vertikal: 1.40

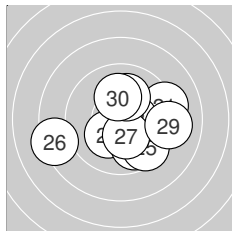

Serie 3:

9.2 →	10.2 *	10.4 *	9.8 ↓	9.5 ↓
8.3 ↙	10.3 *	10.1 ↑	9.1 →	10.1 ↑

beste Teiler: 126.0 (23.), 160.9 (27.), 186.1 (22.)
 Trefferlage: 0.70 mm rechts, 0.54 mm tief
 Streuwert: 2.51, horizontal: 3.04, vertikal: 1.83

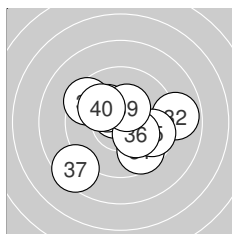

Serie 4:

9.6 ↓	8.9 →	10.6 *	10.2 *	9.7 →
10.2 *	8.5 ↙	9.5 ↘	10.4 *	10.0 ↘

beste Teiler: 85.7 (33.), 148.2 (39.), 181.1 (34.)
 Trefferlage: 0.11 mm rechts, 0.19 mm tief
 Streuwert: 2.51, horizontal: 2.89, vertikal: 2.07



Ergebnis: **305.6** (289)
 Serien: 75.2 75.0 76.7 78.7
 Zähler: 5 6 10 8 2 4 3 1 1 0
 Innenzehner: 3
 Weitester: 2108 (31.), 1970 (25.), 1678 (17.)
 beste Teiler: 137.7 (13.), 161.0 (24.), 182.0 (12.)
 Trefferlage: 2.26 mm rechts, 2.09 mm tief
 Streuwert: 6.55, horizontal: 8.32, vertikal: 4.06

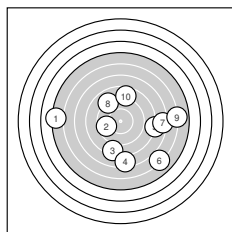
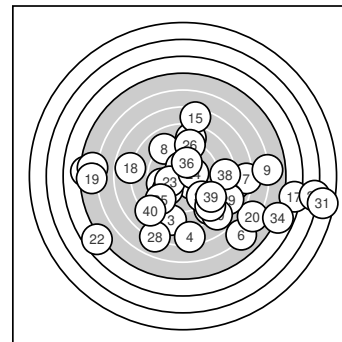

Serie 1:
 5.2 ← 9.6 ← 8.3 ↓ 7.3 ↓ 7.9 →
 6.1 ↘ 7.2 → 9.0 ↘ 5.9 → 8.7 ↑
 beste Teiler: 333.6 (2.), 489.8 (8.), 575.0 (10.)
 Trefferlage: 1.83 mm rechts, 1.55 mm tief
 Streuwert: 6.67, horizontal: 7.99, vertikal: 5.02

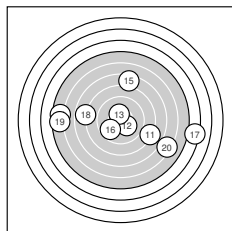

Serie 2:
 8.0 ↘ 10.2 * 10.4 * 5.6 ← 7.4 ↑
 9.7 ↙ 4.2 → 7.8 ← 5.5 ← 6.2 ↘
 beste Teiler: 137.7 (13.), 182.0 (12.), 306.6 (16.)
 Trefferlage: 0.07 mm links, 0.32 mm tief
 Streuwert: 7.44, horizontal: 9.75, vertikal: 3.96

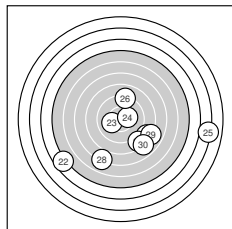

Serie 3:
 8.3 ↘ 4.6 ↙ 10.1 ← 10.3 * 3.1 →
 9.1 ↑ 8.4 ↘ 7.0 ↓ 7.9 ↘ 7.9 ↘
 beste Teiler: 161.0 (24.), 208.7 (23.), 475.2 (26.)
 Trefferlage: 2.46 mm rechts, 3.44 mm tief
 Streuwert: 6.60, horizontal: 8.33, vertikal: 4.22

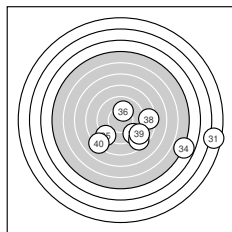

Serie 4:
 2.5 → 8.9 ↘ 9.3 ↘ 4.8 → 9.0 ↙
 10.1 ↑ 8.6 ↘ 8.5 → 8.9 ↘ 8.1 ↙
 beste Teiler: 209.8 (36.), 409.0 (33.), 476.6 (35.)
 Trefferlage: 4.82 mm rechts, 3.03 mm tief
 Streuwert: 5.66, horizontal: 7.63, vertikal: 2.44



Ergebnis: **378.1** (358)
 Serien: 87.7 96.9 95.7 97.8
 Zähler: 12 19 5 3 1 0 0 0 0 0
 Innenzehner: 7
 Weitester: 1074 (4.), 820 (19.), 793 (29.)
 beste Teiler: 14.0 (37.), 112.0 (27.), 120.5 (18.)
 Trefferlage: 2.01 mm links, 0.05 mm hoch
 Streuwert: 2.76, horizontal: 3.25, vertikal: 2.16

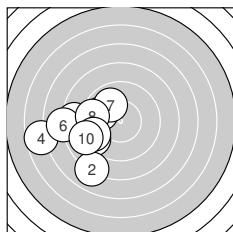
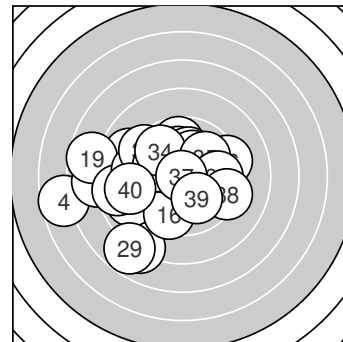

Serie 1:

9.2 ↙	8.0 ↙	9.8 ↖	6.7 ↖	8.5 ↖
7.9 ↖	9.9 ↘	9.4 ↖	9.4 ↙	8.9 ↘

beste Teiler: 253.3 (7.), 277.0 (3.), 379.9 (8.)
 Trefferlage: 4.74 mm links, 1.12 mm tief
 Streuwert: 2.54, horizontal: 2.67, vertikal: 2.40

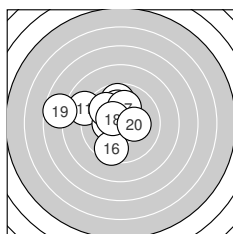

Serie 2:

8.9 ↖	10.3 *	9.7 ↑	10.1 ↑	9.9 ↘
9.5 ↙	10.1 ↑	10.5 *	7.7 ↖	10.2 *

beste Teiler: 120.5 (18.), 154.1 (12.), 179.4 (20.)
 Trefferlage: 1.70 mm links, 0.97 mm hoch
 Streuwert: 2.36, horizontal: 2.80, vertikal: 1.82

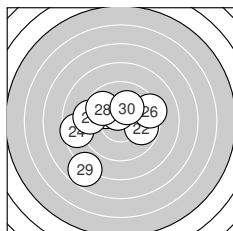

Serie 3:

10.4 *	9.8 →	10.0 ↖	8.6 ↖	9.3 ↖
9.3 →	10.5 *	9.8 ↖	7.8 ↙	10.2 *

beste Teiler: 112.0 (27.), 148.0 (21.), 197.7 (30.)
 Trefferlage: 1.10 mm links, 0.04 mm hoch
 Streuwert: 2.88, horizontal: 3.22, vertikal: 2.48

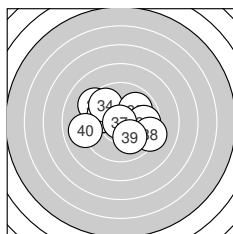

Serie 4:

9.9 ↖	9.3 ↖	10.0 ↖	9.8 ↖	9.9 ↗
9.7 →	10.9 *	9.3 →	10.0 ↘	9.0 ↖

beste Teiler: 14.0 (37.), 229.1 (39.), 237.8 (33.)
 Trefferlage: 0.49 mm links, 0.32 mm hoch
 Streuwert: 2.33, horizontal: 2.92, vertikal: 1.53



Ergebnis: **388.2** (370)
Serien: 96.0 94.9 97.1 100.2
Zähler: 17 17 5 1 0 0 0 0 0 0
Innenzehner: 14
Weiteste: 778 (14.), 637 (21.), 636 (29.)
beste Teiler: 53.7 (32.), 62.2 (23.), 105.3 (30.)
Trefferlage: 0.87 mm links, 0.11 mm hoch
Streuwert: 2.49, horizontal: 3.14, vertikal: 1.59

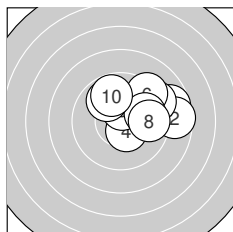
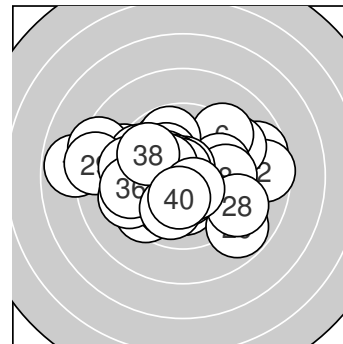

Serie 1:
 8.7 → 8.6 → 9.2 ↗
 9.3 ↗ 9.9 → 9.7 →
beste Teiler: 121.5 (4.), 128.1 (5.), 266.2 (9.)
Trefferlage: 2.18 mm rechts, 1.32 mm hoch
Streuwert: 2.00, horizontal: 2.51, vertikal: 1.28

10.5 * 10.4 *
 9.9 ↘ 9.8 ↘

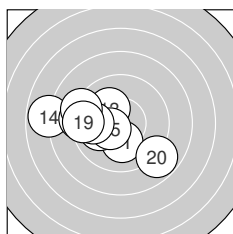

Serie 2:
 10.2 * 10.0 ← 10.2 *
 9.2 ← 9.8 ← 9.2 ↖
beste Teiler: 127.0 (15.), 199.8 (13.), 200.6 (11.)
Trefferlage: 2.39 mm links, 0.24 mm tief
Streuwert: 2.49, horizontal: 3.14, vertikal: 1.60

7.8 ← 10.4 *
 9.3 ← 8.8 ↘

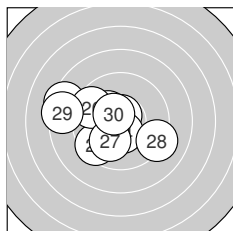

Serie 3:
 8.4 ↖ 10.3 * 10.7 *
 9.6 ↖ 10.0 ↘ 9.2 ↘
beste Teiler: 62.2 (23.), 105.3 (30.), 124.9 (24.)
Trefferlage: 1.71 mm links, 0.11 mm tief
Streuwert: 2.45, horizontal: 3.03, vertikal: 1.69

10.5 * 9.5 ↗
 8.4 ← 10.5 *

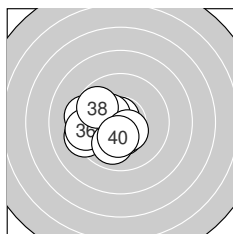

Serie 4:
 9.4 ← 10.7 * 10.4 *
 9.4 ← 10.0 ↘ 9.8 ↖
beste Teiler: 53.7 (32.), 118.6 (39.), 135.7 (34.)
Trefferlage: 1.55 mm links, 0.49 mm tief
Streuwert: 1.55, horizontal: 1.79, vertikal: 1.28

10.4 * 9.3 ←
 10.5 * 10.3 *



Ergebnis: **394.8** (380)
 Serien: 97.3 99.8 100.4 97.3
 Zähler: 21 18 1 0 0 0 0 0 0 0
 Innenzehner: 13
 Weitester: 593 (31.), 484 (2.), 469 (19.)
 beste Teiler: 40.6 (36.), 56.3 (6.), 63.8 (1.)
 Trefferlage: 0.55 mm links, 0.89 mm tief
 Streuwert: 2.04, horizontal: 2.24, vertikal: 1.81

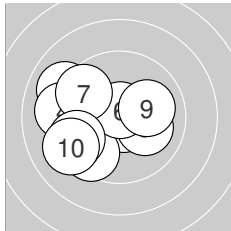
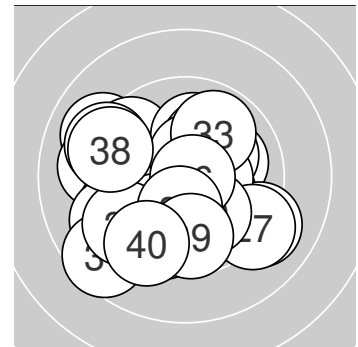

Serie 1:

10.7 *	9.0 ↘	10.1 ↗	9.1 ←	9.5 ↙
10.7 *	9.6 ↘	9.4 ↙	10.0 →	9.2 ↙

beste Teiler: 56.3 (6.), 63.8 (1.), 215.9 (3.)
 Trefferlage: 1.66 mm links, 0.22 mm tief
 Streuwert: 2.19, horizontal: 2.58, vertikal: 1.71

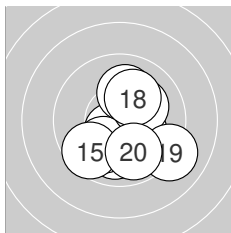

Serie 2:

10.0 ↓	10.5 *	10.3 *	10.0 ↙	9.6 ↙
10.2 *	10.1 ↑	10.1 ↗	9.1 ↘	9.9 ↘

beste Teiler: 102.3 (12.), 172.9 (13.), 197.7 (16.)
 Trefferlage: 0.51 mm rechts, 0.84 mm tief
 Streuwert: 1.82, horizontal: 1.76, vertikal: 1.87

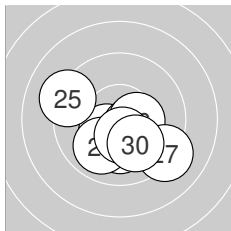

Serie 3:

10.4 *	10.1 ↓	10.5 *	10.3 *	9.2 ↖
10.4 *	9.2 ↘	9.9 ↙	10.4 *	10.0 ↘

beste Teiler: 106.5 (23.), 131.0 (29.), 135.6 (26.)
 Trefferlage: 0.15 mm rechts, 1.14 mm tief
 Streuwert: 1.69, horizontal: 2.04, vertikal: 1.25

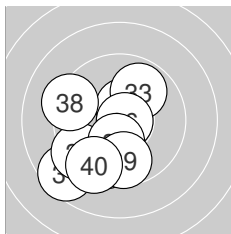

Serie 4:

8.6 ↙	10.5 *	9.9 ↗	9.6 ↓	9.3 ↙
10.8 *	10.3 *	9.3 ↖	9.7 ↓	9.3 ↙

beste Teiler: 40.6 (36.), 112.2 (32.), 174.1 (37.)
 Trefferlage: 1.22 mm links, 1.36 mm tief
 Streuwert: 2.18, horizontal: 2.02, vertikal: 2.34



Ergebnis: **401.1** (382)
 Serien: 102.4 101.3 98.9 98.5
 Zähler: 24 14 2 0 0 0 0 0 0 0
 Innenzehner: 18
 Weitesten: 574 (35.), 541 (29.), 492 (25.)
 beste Teiler: 14.3 (28.), 47.0 (8.), 64.2 (3.)
 Trefferlage: 0.25 mm links, 0.23 mm tief
 Streuwert: 1.89, horizontal: 2.03, vertikal: 1.73

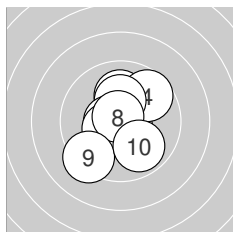
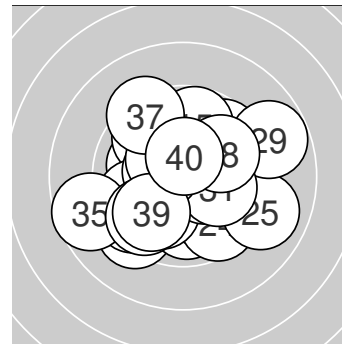

Serie 1:
 10.7 * 10.1 ↑ 10.7 * 9.7 ↗ 10.2 *
 10.6 * 10.4 * 10.8 * 9.3 ↘ 9.9 ↘
 beste Teiler: 47.0 (8.), 64.2 (3.), 70.7 (1.)
 Trefferlage: 0.13 mm links, 0.01 mm tief
 Streuwert: 1.61, horizontal: 1.42, vertikal: 1.78

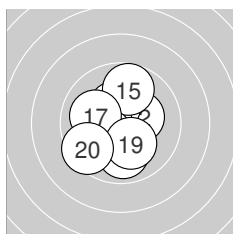

Serie 2:
 10.5 * 10.3 * 10.4 * 10.5 * 9.7 ↑
 10.3 * 10.0 ← 9.9 ↓ 10.2 * 9.5 ↘
 beste Teiler: 111.0 (11.), 124.2 (14.), 149.3 (13.)
 Trefferlage: 0.54 mm links, 0.27 mm tief
 Streuwert: 1.57, horizontal: 1.40, vertikal: 1.72

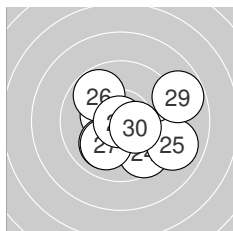

Serie 3:
 10.4 * 10.0 ↘ 10.0 ↘ 9.6 ↘ 9.0 ↘
 9.8 ↘ 10.0 ↘ 10.9 * 8.8 → 10.4 *
 beste Teiler: 14.3 (28.), 136.4 (21.), 138.5 (30.)
 Trefferlage: 0.89 mm rechts, 0.54 mm tief
 Streuwert: 2.14, horizontal: 2.49, vertikal: 1.73

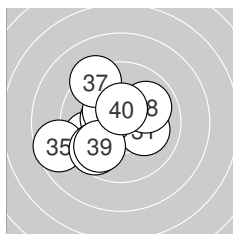

Serie 4:
 10.1 → 9.7 ← 10.4 * 10.4 * 8.7 ←
 9.7 ↘ 9.3 ↘ 9.9 ↗ 9.8 ↘ 10.5 *
 beste Teiler: 115.2 (40.), 130.2 (33.), 145.8 (34.)
 Trefferlage: 1.23 mm links, 0.12 mm tief
 Streuwert: 2.09, horizontal: 2.25, vertikal: 1.90



Ergebnis: **348.2** (331)
 Serien: 85.6 80.8 95.5 86.3
 Zähler: 9 11 10 3 6 1 0 0 0 0
 Innenzehner: 8
 Weitester: 1419 (20.), 1247 (33.), 1233 (12.)
 beste Teiler: 20.5 (31.), 124.8 (3.), 125.0 (24.)
 Trefferlage: 0.56 mm links, 0.29 mm hoch
 Streuwert: 4.80, horizontal: 5.06, vertikal: 4.51

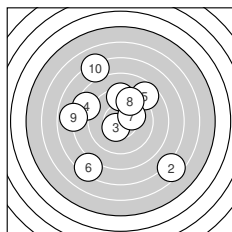
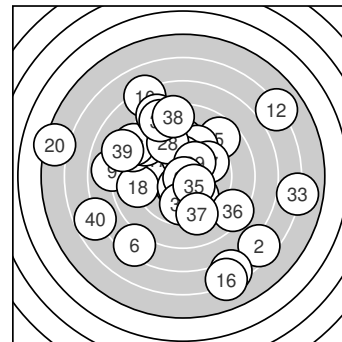

Serie 1:
 9.4 ↑ 6.5 ↘ 10.5 * 8.5 ↖ 8.7 ↗
 7.3 ↙ 10.2 * 9.5 ↗ 7.9 ← 7.1 ↘
 beste Teiler: 124.8 (3.), 197.2 (7.), 354.7 (8.)
 Trefferlage: 0.78 mm links, 0.78 mm hoch
 Streuwert: 4.96, horizontal: 4.88, vertikal: 5.04

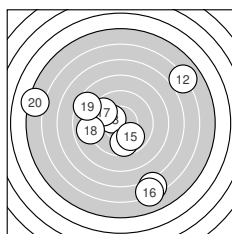

Serie 2:
 6.4 ↘ 6.0 ↗ 10.3 * 9.7 ↓ 9.9 ↘
 6.1 ↘ 9.6 ↖ 9.0 ← 8.5 ↖ 5.3 ←
 beste Teiler: 153.8 (13.), 267.2 (15.), 313.6 (14.)
 Trefferlage: 0.61 mm links, 1.18 mm tief
 Streuwert: 6.25, horizontal: 6.68, vertikal: 5.79

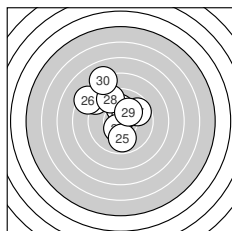

Serie 3:
 8.8 ↖ 10.1 ↑ 10.4 * 10.5 * 9.9 ↓
 8.4 ↖ 9.7 ↗ 9.4 ↘ 10.2 * 8.1 ↘
 beste Teiler: 125.0 (24.), 150.6 (23.), 193.5 (29.)
 Trefferlage: 0.92 mm links, 1.93 mm hoch
 Streuwert: 2.54, horizontal: 2.50, vertikal: 2.58

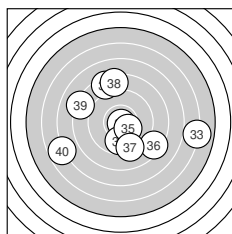

Serie 4:
 10.9 * 9.8 ↓ 6.0 → 8.4 ↗ 10.3 *
 8.4 ↘ 9.2 ↓ 8.4 ↑ 8.1 ↖ 6.8 ↖
 beste Teiler: 20.5 (31.), 154.7 (35.), 300.1 (32.)
 Trefferlage: 0.07 mm rechts, 0.33 mm tief
 Streuwert: 5.11, horizontal: 5.99, vertikal: 4.06



Ergebnis: **390.5** (373)
 Serien: 97.9 97.2 98.0 97.4
 Zähler: 21 13 4 2 0 0 0 0 0 0
 Innenzehner: 17
 Weitester: 853 (4.), 781 (29.), 702 (31.)
 beste Teiler: 29.5 (39.), 63.1 (23.), 87.0 (24.)
 Trefferlage: 0.29 mm rechts, 0.27 mm tief
 Streuwert: 2.54, horizontal: 3.03, vertikal: 1.92

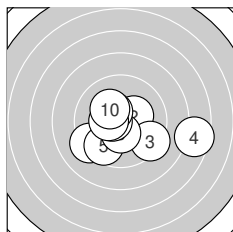
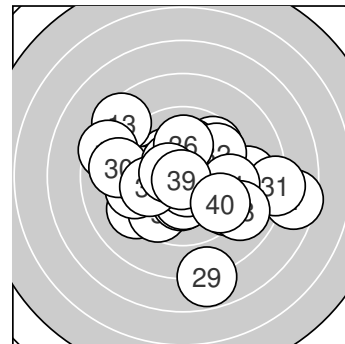

Serie 1:
 9.2 ↙ 10.3 * 9.3 ↘ 7.5 → 9.6 ↙
 10.4 * 10.6 * 10.4 * 10.4 * 10.2 *
 beste Teiler: 93.0 (7.), 135.0 (6.), 136.0 (9.)
 Trefferlage: 0.34 mm rechts, 0.74 mm tief
 Streuwert: 2.63, horizontal: 3.38, vertikal: 1.55

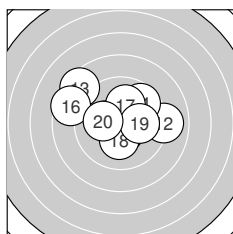

Serie 2:
 10.3 * 9.0 → 8.5 ↘ 9.7 ↗ 10.5 *
 8.6 ↖ 10.1 ↑ 10.2 * 10.1 → 10.2 *
 beste Teiler: 108.2 (15.), 172.1 (11.), 186.6 (18.)
 Trefferlage: 0.39 mm links, 0.79 mm hoch
 Streuwert: 2.59, horizontal: 3.21, vertikal: 1.76

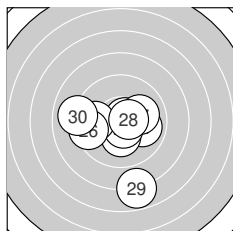

Serie 3:
 9.9 → 10.2 * 10.7 * 10.6 * 9.8 ←
 9.4 ← 10.0 → 10.6 * 7.8 ↓ 9.0 ←
 beste Teiler: 63.1 (23.), 87.0 (24.), 92.9 (28.)
 Trefferlage: 0.32 mm links, 0.98 mm tief
 Streuwert: 2.51, horizontal: 2.56, vertikal: 2.46

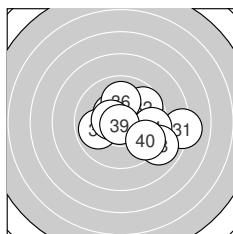

Serie 4:
 8.1 → 9.7 ↗ 10.4 * 9.5 → 9.9 ←
 10.0 ↑ 10.5 * 8.9 ↘ 10.8 * 9.6 ↘
 beste Teiler: 29.5 (39.), 110.8 (37.), 132.3 (33.)
 Trefferlage: 1.56 mm rechts, 0.16 mm tief
 Streuwert: 2.36, horizontal: 2.95, vertikal: 1.56



Ergebnis: **362.4** (343)
 Serien: 92.0 95.1 88.2 87.1
 Zähler: 6 19 9 4 2 0 0 0 0 0
 Innenzehner: 3
 Weitestе: 1116 (30.), 1104 (36.), 928 (26.)
 beste Teiler: 89.0 (20.), 98.4 (28.), 157.9 (4.)
 Trefferlage: 0.39 mm links, 0.45 mm tief
 Streuwert: 3.81, horizontal: 4.08, vertikal: 3.53

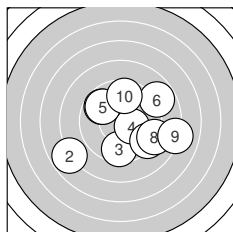
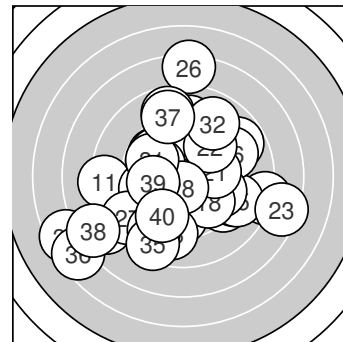

Serie 1:
 9.7 ↘ 7.8 ↙ 9.5 ↓ 10.3 * 9.8 ↘
 8.8 ↗ 9.3 ↘ 9.1 ↘ 8.1 → 9.6 ↑
 beste Teiler: 157.9 (4.), 292.8 (5.), 303.8 (1.)
 Trefferlage: 0.98 mm rechts, 0.52 mm tief
 Streuwert: 3.45, horizontal: 4.03, vertikal: 2.75

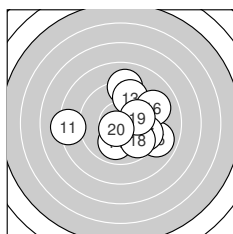

Serie 2:
 8.3 ← 9.1 ↑ 9.6 ↑ 10.0 ↓ 9.0 →
 9.1 → 9.6 → 9.7 ↘ 10.1 → 10.6 *
 beste Teiler: 89.0 (20.), 225.4 (19.), 245.4 (14.)
 Trefferlage: 1.00 mm rechts, 0.15 mm hoch
 Streuwert: 2.86, horizontal: 3.23, vertikal: 2.42

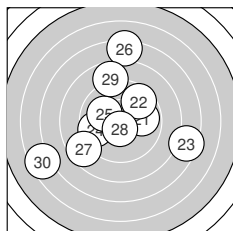

Serie 3:
 9.9 → 9.6 ↗ 7.4 → 9.6 ← 10.1 ↘
 7.2 ↑ 8.6 ↙ 10.6 * 8.7 ↑ 6.5 ←
 beste Teiler: 98.4 (28.), 225.5 (25.), 271.5 (21.)
 Trefferlage: 0.73 mm links, 0.49 mm hoch
 Streuwert: 4.61, horizontal: 4.88, vertikal: 4.32

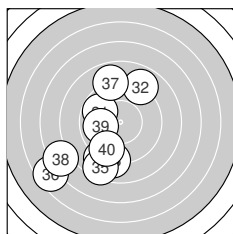

Serie 4:
 9.8 ↘ 8.9 ↗ 9.0 ↓ 8.9 ↓ 8.4 ↓
 6.5 ↙ 8.9 ↑ 7.4 ↙ 9.9 ← 9.4 ↓
 beste Teiler: 258.2 (39.), 295.2 (31.), 379.7 (40.)
 Trefferlage: 2.81 mm links, 1.93 mm tief
 Streuwert: 3.79, horizontal: 3.26, vertikal: 4.25



Ergebnis: **333.2** (315)
 Serien: 85.0 76.9 87.7 83.6
 Zähler: 3 8 14 12 2 1 0 0 0 0
 Innenzehner: 3
 Weitester: 1470 (20.), 1061 (31.), 1016 (13.)
 beste Teiler: 135.7 (6.), 181.8 (35.), 200.2 (8.)
 Trefferlage: 1.15 mm rechts, 1.43 mm tief
 Streuwert: 4.91, horizontal: 5.51, vertikal: 4.21

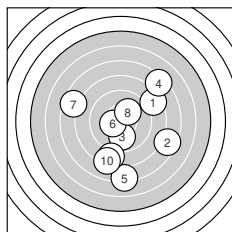
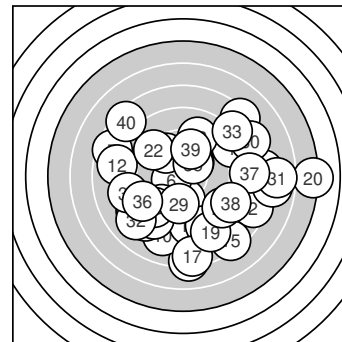

Serie 1:
 8.4 ↗ 7.5 ↘ 9.9 ↓ 7.3 ↗ 7.1 ↓
 10.4 * 7.6 ↖ 10.2 * 8.5 ↓ 8.1 ↓
 beste Teiler: 135.7 (6.), 200.2 (8.), 263.1 (3.)
 Trefferlage: 0.88 mm rechts, 1.44 mm tief
 Streuwert: 4.93, horizontal: 4.74, vertikal: 5.11

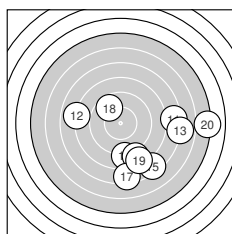

Serie 2:
 7.3 → 7.9 ← 6.9 → 8.7 ↓ 7.3 ↘
 8.5 ↘ 7.3 ↓ 9.7 ↖ 8.2 ↘ 5.1 →
 beste Teiler: 322.6 (18.), 555.4 (14.), 611.7 (16.)
 Trefferlage: 3.72 mm rechts, 3.04 mm tief
 Streuwert: 5.37, horizontal: 6.38, vertikal: 4.12

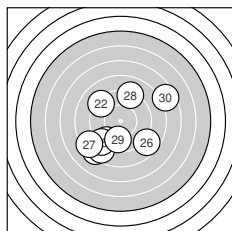

Serie 3:
 9.3 ↙ 9.2 ↘ 8.3 ↙ 8.6 ↙ 9.0 ↙
 8.7 ↘ 8.3 ↙ 9.1 ↑ 9.7 ↓ 7.5 →
 beste Teiler: 313.2 (29.), 401.2 (21.), 444.0 (22.)
 Trefferlage: 0.85 mm links, 1.58 mm tief
 Streuwert: 3.98, horizontal: 4.18, vertikal: 3.77

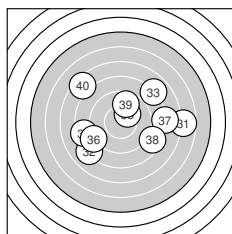

Serie 4:
 6.7 → 8.1 ↙ 7.9 ↗ 8.4 ← 10.2 *
 8.8 ↙ 7.9 → 8.5 ↘ 9.7 ↑ 7.4 ↘
 beste Teiler: 181.8 (35.), 317.7 (39.), 537.5 (36.)
 Trefferlage: 0.86 mm rechts, 0.32 mm hoch
 Streuwert: 5.12, horizontal: 6.26, vertikal: 3.63



Ergebnis: **346.5** (327)
 Serien: 89.5 82.7 88.0 86.3
 Zähler: 3 15 10 10 2 0 0 0 0 0
 Innenzehner: 2
 Weitester: 1195 (30.), 1149 (14.), 897 (16.)
 beste Teiler: 86.8 (1.), 187.7 (36.), 238.9 (35.)
 Trefferlage: 0.91 mm rechts, 1.81 mm tief
 Streuwert: 4.27, horizontal: 4.41, vertikal: 4.13

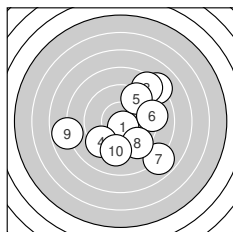
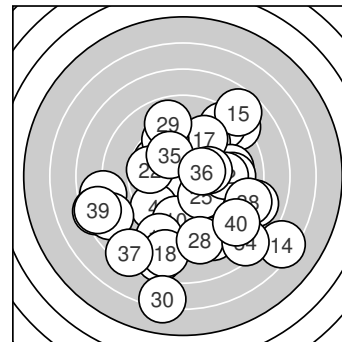

Serie 1:
 10.6 * 8.2 ↗ 8.5 ↗ 9.3 ↙ 9.4 ↗
 9.1 → 7.9 ↘ 9.4 ↘ 7.8 ← 9.3 ↓
 beste Teiler: 86.8 (1.), 394.8 (8.), 397.8 (5.)
 Trefferlage: 1.29 mm rechts, 0.45 mm tief
 Streuwert: 3.91, horizontal: 4.12, vertikal: 3.70

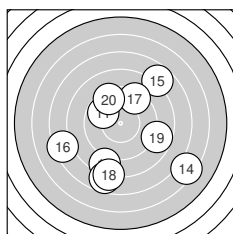

Serie 2:
 9.8 ↘ 8.4 ↓ 7.7 ↓ 6.4 ↘ 7.7 ↗
 7.4 ← 9.3 ↗ 7.9 ↓ 8.7 → 9.4 ↖
 beste Teiler: 290.6 (11.), 386.8 (20.), 409.8 (17.)
 Trefferlage: 0.32 mm rechts, 1.83 mm tief
 Streuwert: 5.15, horizontal: 5.16, vertikal: 5.15

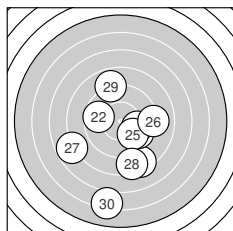

Serie 3:
 8.4 ↓ 9.7 ← 9.7 ↘ 9.9 → 9.9 ↘
 9.1 → 7.8 ← 8.4 ↓ 8.9 ↑ 6.2 ↓
 beste Teiler: 252.0 (24.), 254.6 (25.), 303.1 (23.)
 Trefferlage: 0.23 mm rechts, 2.62 mm tief
 Streuwert: 4.09, horizontal: 3.53, vertikal: 4.58

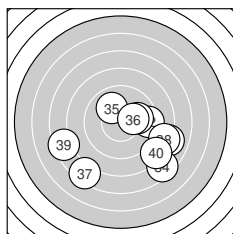

Serie 4:
 8.0 → 9.3 → 9.9 → 7.5 ↘ 10.0 ↖
 10.2 * 7.4 ↙ 8.3 → 7.4 ← 8.3 ↘
 beste Teiler: 187.7 (36.), 238.9 (35.), 252.5 (33.)
 Trefferlage: 1.79 mm rechts, 2.33 mm tief
 Streuwert: 4.24, horizontal: 5.13, vertikal: 3.11



Ergebnis: **393.7** (376)
Serien: 99.3 96.5 99.5 98.4
Zähler: 17 22 1 0 0 0 0 0 0 0
Innenzehner: 14
Weiteste: 607 (16.), 472 (17.), 436 (3.)
beste Teiler: 56.3 (21.), 118.5 (18.), 145.4 (15.)
Trefferlage: 0.01 mm rechts, 0.29 mm hoch
Streuwert: 2.12, horizontal: 2.51, vertikal: 1.64

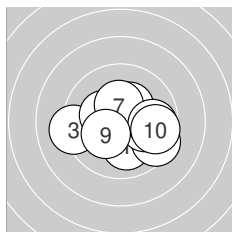
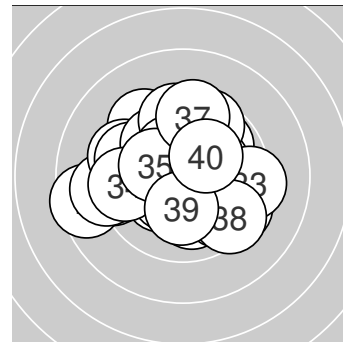

Serie 1:
 10.0 ↓ 10.3 * 9.2 ← 9.5 ↘ 10.3 *
 10.0 → 10.4 * 9.8 → 10.2 * 9.6 →
beste Teiler: 150.8 (7.), 155.5 (2.), 163.6 (5.)
Trefferlage: 0.55 mm rechts, 0.41 mm tief
Streuwert: 1.95, horizontal: 2.46, vertikal: 1.24

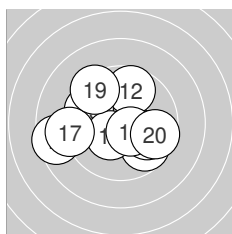

Serie 2:
 9.7 ↘ 9.7 ↑ 9.7 ← 9.9 ↘ 10.4 *
 8.5 ← 9.1 ← 10.5 * 9.4 ↘ 9.6 →
beste Teiler: 118.5 (18.), 145.4 (15.), 266.7 (14.)
Trefferlage: 0.71 mm links, 0.11 mm tief
Streuwert: 2.58, horizontal: 3.14, vertikal: 1.87

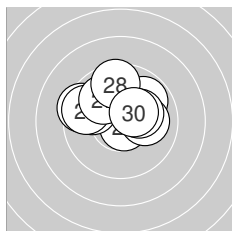

Serie 3:
 10.7 * 9.8 ↗ 9.8 ← 9.4 ← 9.6 ←
 10.1 → 9.9 ↘ 9.6 ↑ 10.2 * 10.4 *
beste Teiler: 56.3 (21.), 146.1 (30.), 183.8 (29.)
Trefferlage: 0.38 mm links, 1.15 mm hoch
Streuwert: 1.75, horizontal: 2.22, vertikal: 1.08

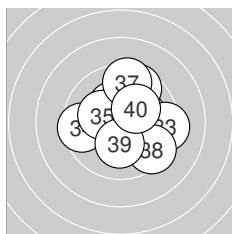

Serie 4:
 10.2 * 10.3 * 9.3 → 9.5 ← 10.2 *
 9.6 ↑ 9.5 ↑ 9.4 ↘ 10.2 * 10.2 *
beste Teiler: 163.2 (32.), 180.4 (35.), 186.3 (40.)
Trefferlage: 0.61 mm rechts, 0.55 mm hoch
Streuwert: 2.10, horizontal: 2.22, vertikal: 1.97



Ergebnis: **401.8** (382)
 Serien: 98.7 98.6 102.0 102.5
 Zähler: 22 18 0 0 0 0 0 0 0 0
 Innenzehner: 18
 Weitester: 499 (14.), 461 (9.), 438 (30.)
 beste Teiler: 31.3 (36.), 39.0 (24.), 63.7 (32.)
 Trefferlage: 0.11 mm links, 0.10 mm hoch
 Streuwert: 1.84, horizontal: 2.16, vertikal: 1.45

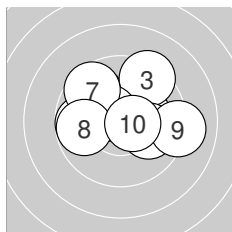
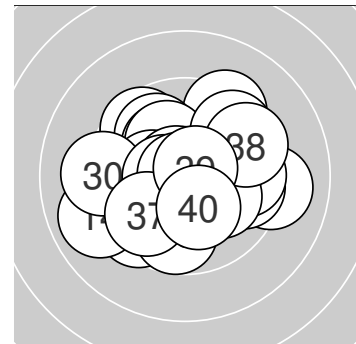

Serie 1:

10.2 *	9.8 ↘	9.3 ↗	9.8 ←	10.5 *
10.0 →	9.6 ↘	9.8 ←	9.1 →	10.6 *

beste Teiler: 98.6 (10.), 112.4 (5.), 180.3 (1.)
 Trefferlage: 0.04 mm rechts, 0.71 mm hoch
 Streuwert: 2.13, horizontal: 2.62, vertikal: 1.48

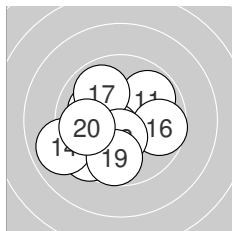

Serie 2:

9.9 ↗	9.5 ↙	10.5 *	9.0 ←	10.1 ↖
9.7 →	9.9 ↘	10.4 *	9.7 ↓	9.9 ←

beste Teiler: 106.2 (13.), 135.2 (18.), 214.6 (15.)
 Trefferlage: 0.92 mm links, 0.63 mm tief
 Streuwert: 2.03, horizontal: 2.28, vertikal: 1.75

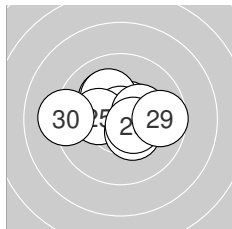

Serie 3:

10.2 *	10.6 *	10.1 ↘	10.8 *	10.2 *
10.4 *	10.3 *	10.5 *	9.7 →	9.2 ←

beste Teiler: 39.0 (24.), 96.5 (22.), 113.1 (28.)
 Trefferlage: 0.10 mm links, 0.40 mm hoch
 Streuwert: 1.59, horizontal: 2.08, vertikal: 0.86

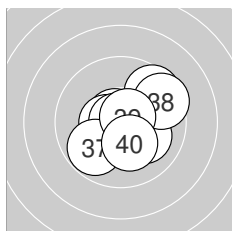

Serie 4:

10.1 ↘	10.7 *	9.6 ↗	10.5 *	10.6 *
10.8 *	9.8 ↙	9.5 ↗	10.7 *	10.2 *

beste Teiler: 31.3 (36.), 63.7 (32.), 70.6 (39.)
 Trefferlage: 0.51 mm rechts, 0.06 mm tief
 Streuwert: 1.52, horizontal: 1.64, vertikal: 1.38



Ergebnis: **408.8** (390)
 Serien: 102.0 102.1 103.7 101.0
 Zähler: 30 10 0 0 0 0 0 0 0 0
 Innenzehner: 24
 Weitester: 390 (9.), 350 (33.), 335 (31.)
 beste Teiler: 52.9 (5.), 54.9 (13.), 63.8 (40.)
 Trefferlage: 0.39 mm links, 0.21 mm hoch
 Streuwert: 1.43, horizontal: 1.75, vertikal: 1.02

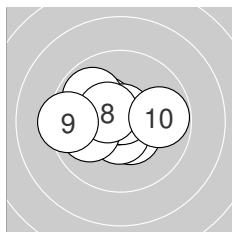
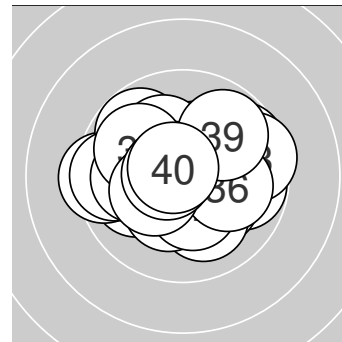

Serie 1:
 10.3 * 10.5 * 10.6 * 10.3 * 10.7 *
 9.9 ↘ 10.0 ← 10.5 * 9.4 ← 9.8 →
 beste Teiler: 52.9 (5.), 93.6 (3.), 115.9 (8.)
 Trefferlage: 0.82 mm links, 0.25 mm hoch
 Streuwert: 1.47, horizontal: 1.85, vertikal: 0.92

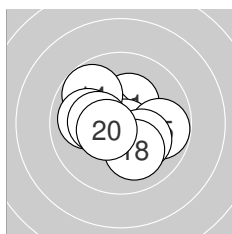

Serie 2:
 10.3 * 10.4 * 10.7 * 9.8 ↘ 9.8 →
 10.0 ← 10.2 * 10.1 ↘ 10.3 * 10.5 *
 beste Teiler: 54.9 (13.), 114.0 (20.), 128.7 (12.)
 Trefferlage: 0.21 mm links, 0.01 mm tief
 Streuwert: 1.49, horizontal: 1.75, vertikal: 1.19

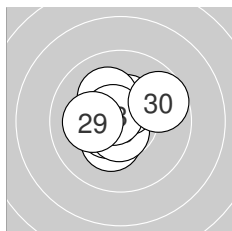

Serie 3:
 10.7 * 10.3 * 10.5 * 10.4 * 10.7 *
 10.4 * 10.2 * 10.7 * 10.1 ← 9.7 →
 beste Teiler: 67.7 (21.), 72.4 (28.), 75.8 (25.)
 Trefferlage: 0.27 mm links, 0.39 mm hoch
 Streuwert: 1.17, horizontal: 1.27, vertikal: 1.06

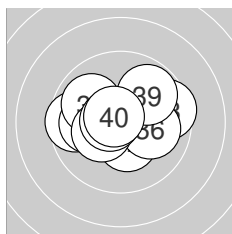

Serie 4:
 9.6 ← 10.4 * 9.6 → 10.0 ← 9.9 ↘
 10.1 → 10.3 * 10.6 * 9.8 ↗ 10.7 *
 beste Teiler: 63.8 (40.), 79.5 (38.), 150.2 (32.)
 Trefferlage: 0.24 mm links, 0.21 mm hoch
 Streuwert: 1.72, horizontal: 2.21, vertikal: 1.01



Ergebnis: **386.9** (371)
 Serien: 100.2 95.1 96.4 95.2
 Zähler: 16 20 3 1 0 0 0 0 0 0
 Innenzehner: 11
 Weitester: 842 (19.), 708 (16.), 667 (32.)
 beste Teiler: 30.0 (9.), 36.0 (36.), 62.6 (30.)
 Trefferlage: 0.42 mm rechts, 0.24 mm tief
 Streuwert: 2.61, horizontal: 2.93, vertikal: 2.24

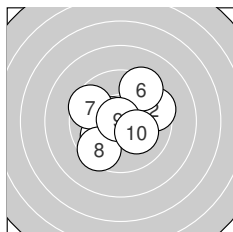
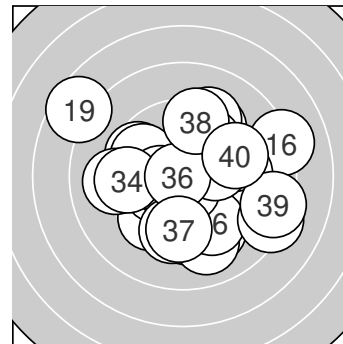

Serie 1:
 10.2 * 9.5 → 10.4 * 10.0 ✓ 10.6 *
 9.4 ↗ 9.6 ↖ 9.5 ✓ 10.8 * 10.2 *
 beste Teiler: 30.0 (9.), 91.7 (5.), 137.3 (3.)
 Trefferlage: 0.40 mm links, 0.04 mm hoch
 Streuwert: 1.93, horizontal: 2.11, vertikal: 1.72

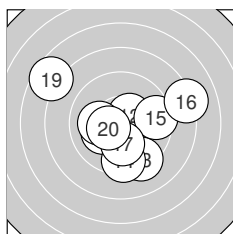

Serie 2:
 10.1 ← 10.5 * 9.3 ↘ 9.4 ↓ 9.5 →
 8.1 → 10.1 ↓ 10.1 ← 7.6 ↖ 10.4 *
 beste Teiler: 121.8 (12.), 133.3 (20.), 203.4 (11.)
 Trefferlage: 0.15 mm rechts, 0.27 mm tief
 Streuwert: 3.18, horizontal: 3.70, vertikal: 2.57

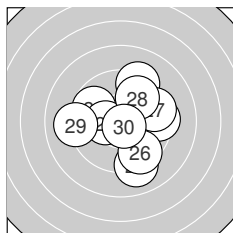

Serie 3:
 9.1 ↓ 9.3 ↗ 9.7 ↖ 9.4 → 10.3 *
 9.5 ↘ 9.5 → 9.8 ↗ 9.1 ← 10.7 *
 beste Teiler: 62.6 (30.), 154.9 (25.), 293.8 (28.)
 Trefferlage: 0.58 mm rechts, 0.02 mm hoch
 Streuwert: 2.59, horizontal: 2.73, vertikal: 2.45

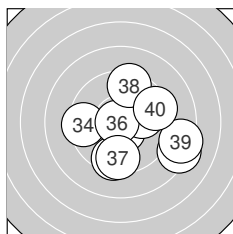

Serie 4:
 10.6 * 8.3 ↘ 10.0 → 9.4 ← 9.4 ↓
 10.8 * 9.5 ↓ 9.4 ↑ 8.4 → 9.4 →
 beste Teiler: 36.0 (36.), 93.6 (31.), 226.5 (33.)
 Trefferlage: 1.38 mm rechts, 0.76 mm tief
 Streuwert: 2.78, horizontal: 3.13, vertikal: 2.37



Ergebnis: **396.2** (377)
 Serien: 100.6 100.6 97.4 97.6
 Zähler: 19 19 2 0 0 0 0 0 0 0
 Innenzehner: 11
 Weitesten: 548 (16.), 547 (30.), 475 (35.)
 beste Teiler: 62.1 (19.), 74.2 (3.), 95.5 (11.)
 Trefferlage: 0.52 mm links, 0.67 mm hoch
 Streuwert: 1.98, horizontal: 2.14, vertikal: 1.81

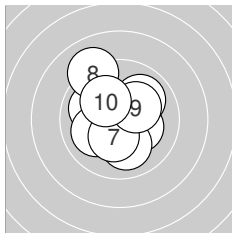
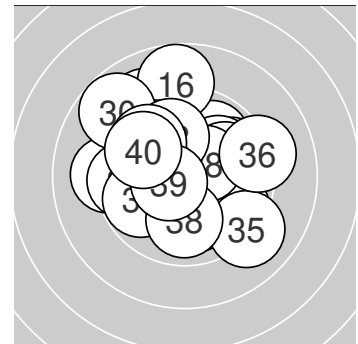

Serie 1:

10.2 *	10.0 ↖	10.7 *	10.0 ↗	10.0 ↖
10.0 ↓	10.3 *	9.1 ↘	10.2 *	10.1 ↘

beste Teiler: 74.2 (3.), 157.8 (7.), 176.2 (1.)
 Trefferlage: 0.35 mm links, 0.35 mm hoch
 Streuwert: 1.75, horizontal: 1.62, vertikal: 1.86

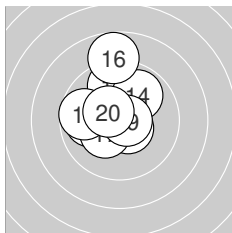

Serie 2:

10.6 *	10.5 *	9.7 ↑	9.9 ↗	9.9 ←
8.8 ↑	10.3 *	9.7 ←	10.7 *	10.5 *

beste Teiler: 62.1 (19.), 95.5 (11.), 101.8 (12.)
 Trefferlage: 0.68 mm links, 1.06 mm hoch
 Streuwert: 1.73, horizontal: 1.43, vertikal: 1.98

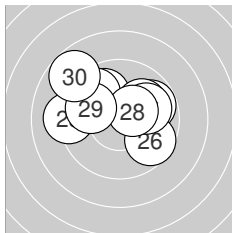

Serie 3:

9.9 ↘	9.8 ↗	10.0 ↗	9.7 ↘	9.2 ←
9.7 ↘	10.0 ↗	10.4 *	9.9 ↖	8.8 ↘

beste Teiler: 135.3 (28.), 233.5 (23.), 250.8 (27.)
 Trefferlage: 0.36 mm links, 1.16 mm hoch
 Streuwert: 2.26, horizontal: 2.83, vertikal: 1.47

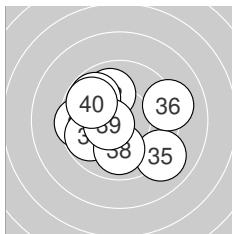

Serie 4:

9.8 ↘	10.0 ↖	9.8 ↘	9.6 ←	9.1 ↘
9.2 ↗	9.8 ↖	9.9 ↓	10.6 *	9.8 ↘

beste Teiler: 100.6 (39.), 243.5 (32.), 253.0 (38.)
 Trefferlage: 0.70 mm links, 0.10 mm hoch
 Streuwert: 2.31, horizontal: 2.65, vertikal: 1.93



Ergebnis: **392.5** (374)
 Serien: 100.1 97.6 99.4 95.4
 Zähler: 17 20 3 0 0 0 0 0 0
 Innenzehner: 11
 Weitester: 627 (40.), 551 (12.), 524 (35.)
 beste Teiler: 28.2 (3.), 86.0 (17.), 87.0 (7.)
 Trefferlage: 0.14 mm links, 0.00 mm
 Streuwert: 2.23, horizontal: 2.54, vertikal: 1.86

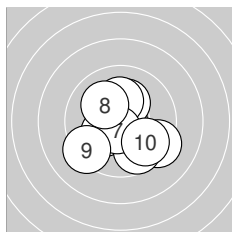
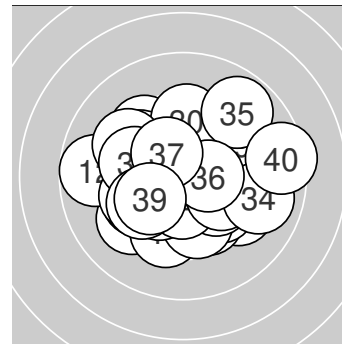

Serie 1:
 10.2 * 9.3 ↘ 10.8 * 9.7 ↓ 10.2 *
 10.2 * 10.6 * 10.1 ↖ 9.3 ↗ 9.7 ↘
 beste Teiler: 28.2 (3.), 87.0 (7.), 181.5 (5.)
 Trefferlage: 0.15 mm rechts, 0.60 mm tief
 Streuwert: 1.90, horizontal: 1.97, vertikal: 1.82

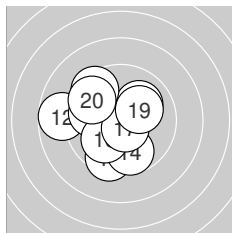

Serie 2:
 9.5 ↓ 8.7 ← 10.0 ↗ 9.7 ↓ 9.9 ←
 10.0 ↗ 10.6 * 9.5 ↘ 10.1 ↗ 9.6 ↘
 beste Teiler: 86.0 (17.), 202.4 (19.), 227.6 (13.)
 Trefferlage: 1.10 mm links, 0.07 mm tief
 Streuwert: 2.21, horizontal: 2.33, vertikal: 2.10

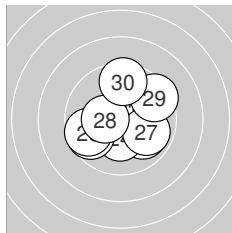

Serie 3:
 9.9 ↘ 10.1 ↗ 10.5 * 10.3 * 9.7 ←
 9.6 ← 9.9 ↘ 10.4 * 9.5 ↗ 9.5 ↑
 beste Teiler: 116.2 (23.), 145.0 (28.), 170.0 (24.)
 Trefferlage: 0.24 mm rechts, 0.11 mm hoch
 Streuwert: 1.99, horizontal: 2.13, vertikal: 1.85

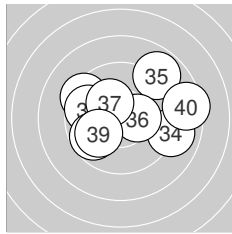

Serie 4:
 9.4 ↘ 9.8 ← 9.7 ← 9.0 → 8.9 ↗
 10.3 * 10.2 * 9.7 ↗ 10.0 ↗ 8.4 →
 beste Teiler: 158.0 (36.), 176.7 (37.), 250.1 (39.)
 Trefferlage: 0.10 mm rechts, 0.54 mm hoch
 Streuwert: 2.82, horizontal: 3.57, vertikal: 1.77



Ergebnis: **360.3** (341)
 Serien: 86.0 90.6 88.8 94.9
 Zähler: 4 16 17 3 0 0 0 0 0 0
 Innenzehner: 3
 Weitester: 921 (6.), 798 (8.), 784 (3.)
 beste Teiler: 39.3 (34.), 73.3 (35.), 136.3 (4.)
 Trefferlage: 1.51 mm rechts, 0.58 mm hoch
 Streuwert: 3.54, horizontal: 4.05, vertikal: 2.94

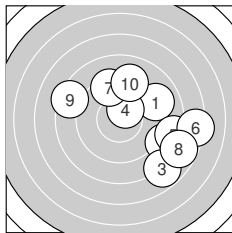
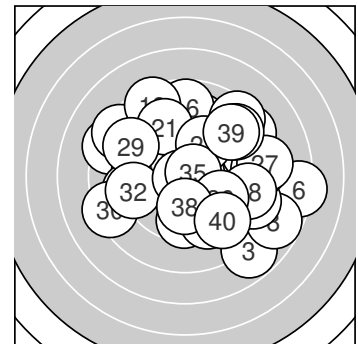

Serie 1:

9.0 ↗	8.5 ↘	7.8 ↘	10.4 *	8.3 →
7.3 →	9.4 ↗	7.8 ↘	8.4 ↖	9.1 ↑

beste Teiler: 136.3 (4.), 400.6 (7.), 455.3 (10.)
 Trefferlage: 3.22 mm rechts, 0.13 mm tief
 Streuwert: 4.02, horizontal: 4.55, vertikal: 3.42

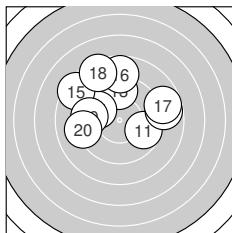

Serie 2:

9.7 ↘	8.8 →	9.5 ↑	9.8 ↖	8.4 ↖
8.7 ↑	8.7 →	8.4 ↗	9.5 ←	9.1 ←

beste Teiler: 288.0 (14.), 311.6 (11.), 354.0 (13.)
 Trefferlage: 0.50 mm links, 2.06 mm hoch
 Streuwert: 3.24, horizontal: 3.87, vertikal: 2.46

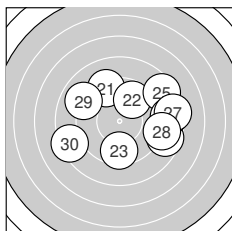

Serie 3:

9.2 ↘	9.8 ↗	9.5 ↓	8.6 ↘	8.5 ↗
8.6 →	8.4 →	8.9 →	9.0 ↖	8.3 ←

beste Teiler: 298.9 (22.), 354.0 (23.), 429.1 (21.)
 Trefferlage: 1.74 mm rechts, 0.46 mm hoch
 Streuwert: 3.74, horizontal: 4.57, vertikal: 2.68

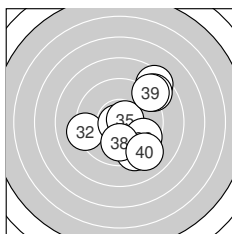

Serie 4:

9.3 ↘	9.2 ←	8.5 ↗	10.8 *	10.7 *
9.6 ↘	8.8 ↗	10.0 ↓	8.9 ↗	9.1 ↘

beste Teiler: 39.3 (34.), 73.3 (35.), 243.0 (38.)
 Trefferlage: 1.58 mm rechts, 0.06 mm tief
 Streuwert: 2.82, horizontal: 2.61, vertikal: 3.02



Ergebnis: **399.9** (383)
 Serien: 99.1 100.1 99.6 101.1
 Zähler: 26 11 3 0 0 0 0 0 0
 Innenzehner: 19
 Weitester: 598 (15.), 557 (18.), 545 (34.)
 beste Teiler: 46.1 (20.), 74.4 (32.), 88.0 (31.)
 Trefferlage: 0.03 mm rechts, 0.18 mm tief
 Streuwert: 1.97, horizontal: 2.17, vertikal: 1.75

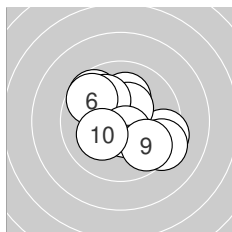
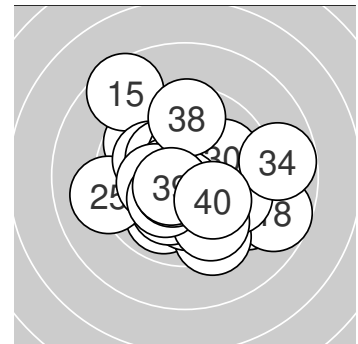

Serie 1:

10.1 ↑	9.7 ↘	9.4 →	10.4 *	10.0 ↘
9.7 ↘	10.6 *	9.3 ↘	9.7 ↘	10.2 *

beste Teiler: 100.6 (7.), 130.6 (4.), 197.2 (10.)
 Trefferlage: 0.32 mm rechts, 0.18 mm hoch
 Streuwert: 2.06, horizontal: 2.30, vertikal: 1.80

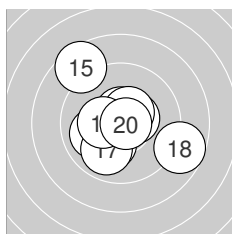

Serie 2:

10.2 *	10.0 ←	10.5 *	10.6 *	8.6 ↘
10.5 *	9.9 ↘	8.7 →	10.3 *	10.8 *

beste Teiler: 46.1 (20.), 92.0 (14.), 117.4 (16.)
 Trefferlage: 0.18 mm links, 0.01 mm hoch
 Streuwert: 2.23, horizontal: 2.35, vertikal: 2.09

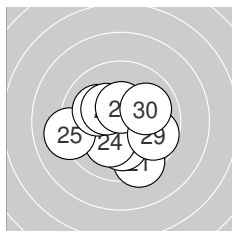

Serie 3:

9.4 ↓	10.1 ↓	10.2 *	10.2 *	9.1 ←
10.1 ↘	10.3 *	10.5 *	9.7 →	10.0 →

beste Teiler: 120.1 (28.), 160.9 (27.), 178.3 (23.)
 Trefferlage: 0.34 mm links, 0.56 mm tief
 Streuwert: 1.93, horizontal: 2.19, vertikal: 1.62

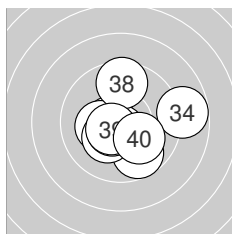

Serie 4:

10.6 *	10.7 *	9.7 ↘	8.8 →	10.2 *
10.3 *	10.5 *	9.6 ↑	10.6 *	10.1 ↘

beste Teiler: 74.4 (32.), 88.0 (31.), 100.0 (39.)
 Trefferlage: 0.32 mm rechts, 0.35 mm tief
 Streuwert: 1.86, horizontal: 2.09, vertikal: 1.61



Ergebnis: **390.2** (375)
 Serien: 99.6 98.1 96.5 96.0
 Zähler: 20 15 5 0 0 0 0 0 0 0
 Innenzehner: 12
 Weitester: 738 (37.), 623 (13.), 532 (11.)
 beste Teiler: 46.8 (19.), 63.5 (1.), 95.2 (27.)
 Trefferlage: 0.03 mm rechts, 0.64 mm tief
 Streuwert: 2.38, horizontal: 2.09, vertikal: 2.65

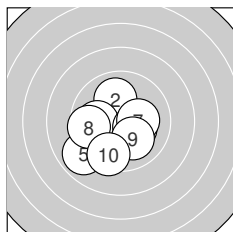
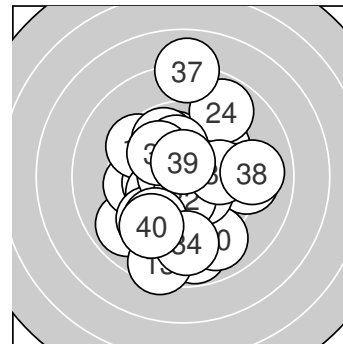

Serie 1:
 10.7 * 10.0 ↑ 10.0 ← 10.3 * 8.9 ↙
 10.3 * 10.2 * 9.6 ← 10.1 ↘ 9.5 ↘
 beste Teiler: 63.5 (1.), 154.1 (6.), 174.4 (4.)
 Trefferlage: 0.51 mm links, 0.88 mm tief
 Streuwert: 1.92, horizontal: 2.13, vertikal: 1.68

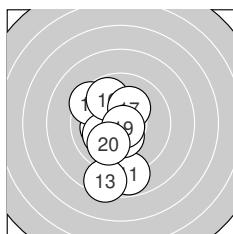

Serie 2:
 8.8 ↓ 10.1 ← 8.5 ↓ 9.4 ↖ 10.1 ↘
 9.8 ↖ 10.2 * 10.4 * 10.8 * 10.0 ↘
 beste Teiler: 46.8 (19.), 138.9 (18.), 183.0 (17.)
 Trefferlage: 0.89 mm links, 1.05 mm tief
 Streuwert: 2.25, horizontal: 1.36, vertikal: 2.87

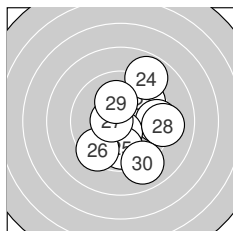

Serie 3:
 9.7 ↗ 9.4 → 10.5 * 8.8 ↗ 9.8 ↓
 9.4 ↘ 10.6 * 9.2 → 10.1 ↑ 9.0 ↘
 beste Teiler: 95.2 (27.), 117.0 (23.), 206.4 (29.)
 Trefferlage: 1.19 mm rechts, 0.30 mm tief
 Streuwert: 2.47, horizontal: 2.24, vertikal: 2.68

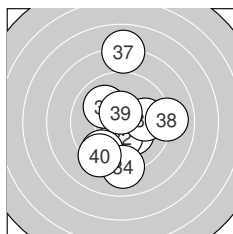

Serie 4:
 10.3 * 10.3 * 9.5 ↘ 9.1 ↓ 9.9 →
 10.0 ↘ 8.0 ↑ 9.0 → 10.6 * 9.3 ↘
 beste Teiler: 99.0 (39.), 156.2 (32.), 174.6 (31.)
 Trefferlage: 0.34 mm rechts, 0.34 mm tief
 Streuwert: 2.85, horizontal: 2.16, vertikal: 3.40



Ergebnis: **382.9** (363)
 Serien: 95.4 94.7 97.0 95.8
 Zähler: 12 19 9 0 0 0 0 0 0
 Innenzehner: 9
 Weitester: 712 (3.), 684 (15.), 676 (33.)
 beste Teiler: 3.6 (23.), 56.5 (38.), 59.0 (6.)
 Trefferlage: 1.19 mm links, 0.48 mm hoch
 Streuwert: 2.62, horizontal: 3.14, vertikal: 1.96

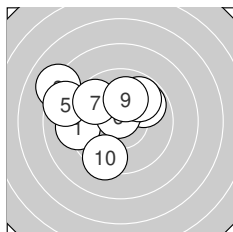
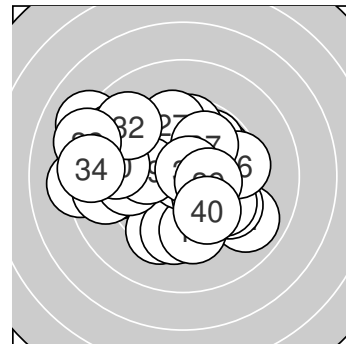

Serie 1:
 9.2 ← 9.8 ↗ 8.1 ↖
 10.7 * 9.7 ↘ 9.8 ↗
 beste Teiler: 59.0 (6.), 225.8 (9.), 236.5 (4.)
 Trefferlage: 1.45 mm links, 1.15 mm hoch
 Streuwert: 2.59, horizontal: 3.08, vertikal: 1.99

10.0 ↗ 8.6 ↖
 10.1 ↑ 9.4 ↓

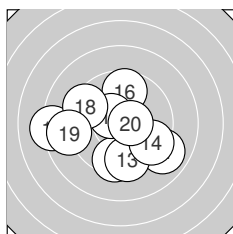

Serie 2:
 8.9 ↘ 9.5 ↓ 9.5 ↓
 9.7 ↑ 10.5 * 9.4 ↖
 beste Teiler: 100.0 (20.), 117.6 (17.), 322.4 (16.)
 Trefferlage: 0.77 mm links, 0.77 mm tief
 Streuwert: 2.94, horizontal: 3.49, vertikal: 2.26

9.5 ↘ 8.2 ←
 8.9 ← 10.6 *

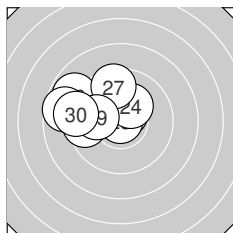

Serie 3:
 9.7 ↖ 10.6 * 10.9 *
 8.8 ↖ 9.5 ↑ 8.7 ←
 beste Teiler: 3.6 (23.), 88.7 (22.), 182.4 (24.)
 Trefferlage: 2.23 mm links, 1.19 mm hoch
 Streuwert: 1.84, horizontal: 2.32, vertikal: 1.17

10.2 * 9.5 ←
 10.0 ← 9.1 ←

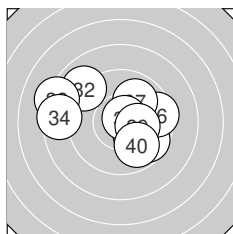

Serie 4:
 9.7 ↘ 9.0 ↖ 8.2 ↖
 9.5 → 9.9 ↗ 10.7 *
 beste Teiler: 56.5 (38.), 173.2 (39.), 197.8 (35.)
 Trefferlage: 0.32 mm links, 0.36 mm hoch
 Streuwert: 2.89, horizontal: 3.66, vertikal: 1.84

8.5 ← 10.2 *
 10.3 * 9.8 ↘



Ergebnis: **408.0** (389)
Serien: 101.8 103.0 100.7 102.5
Zähler: 29 11 0 0 0 0 0 0 0 0
Innenzehner: 24
Weiteste: 479 (3.), 374 (30.), 319 (22.)
beste Teiler: 51.7 (4.), 56.3 (39.), 70.5 (7.)
Trefferlage: 0.43 mm rechts, 0.04 mm tief
Streuwert: 1.48, horizontal: 1.57, vertikal: 1.38

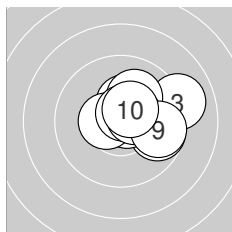
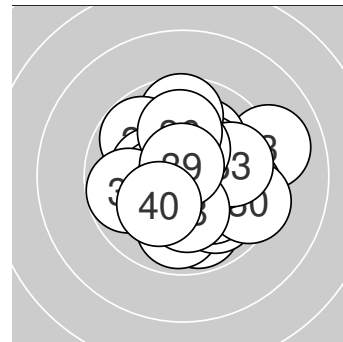

Serie 1:
 9.7 → 10.4 * 9.0 → 10.7 * 10.5 *
 10.1 ↗ 10.7 * 10.5 * 9.7 → 10.5 *
beste Teiler: 51.7 (4.), 70.5 (7.), 113.0 (5.)
Trefferlage: 1.33 mm rechts, 0.54 mm hoch
Streuwert: 1.35, horizontal: 1.67, vertikal: 0.93

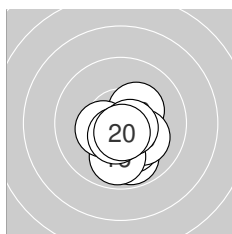

Serie 2:
 10.5 * 10.3 * 9.8 ↓ 10.2 * 10.1 ↘
 9.9 ↓ 10.4 * 10.6 * 10.5 * 10.7 *
beste Teiler: 74.8 (20.), 82.7 (18.), 105.3 (11.)
Trefferlage: 0.32 mm rechts, 1.07 mm tief
Streuwert: 1.01, horizontal: 0.91, vertikal: 1.10

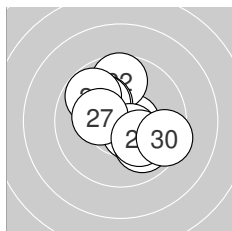

Serie 3:
 10.6 * 9.7 ↑ 10.2 * 10.1 ↘ 10.5 *
 9.8 ↘ 10.3 * 9.9 ↘ 10.1 ↘ 9.5 →
beste Teiler: 87.4 (21.), 114.0 (25.), 167.6 (27.)
Trefferlage: 0.16 mm rechts, 0.28 mm hoch
Streuwert: 1.75, horizontal: 1.82, vertikal: 1.67

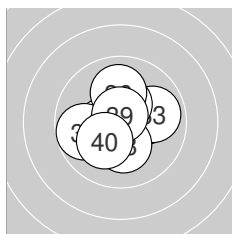

Serie 4:
 10.2 * 10.4 * 9.9 → 9.8 ← 10.4 *
 10.0 ↑ 10.7 * 10.2 * 10.7 * 10.2 *
beste Teiler: 56.3 (39.), 73.7 (37.), 126.6 (32.)
Trefferlage: 0.10 mm links, 0.04 mm hoch
Streuwert: 1.43, horizontal: 1.56, vertikal: 1.29



Ergebnis: **409.4** (393)
Serien: 102.4 102.6 104.2 100.2
Zähler: 33 7 0 0 0 0 0 0 0 0
Innenzehner: 26
Weiteste: 411 (38.), 320 (32.), 309 (33.)
beste Teiler: 62.3 (15.), 67.2 (23.), 68.0 (40.)
Trefferlage: 0.13 mm rechts, 0.34 mm tief
Streuwert: 1.39, horizontal: 1.28, vertikal: 1.49

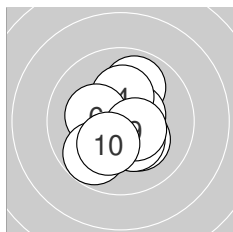
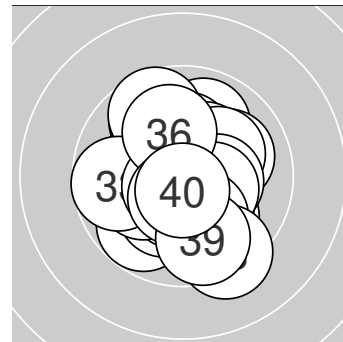

Serie 1:
 9.9 ↗ 10.5 * 10.2 * 10.2 * 10.6 *
 10.2 * 10.3 * 9.8 ↘ 10.5 * 10.2 *
beste Teiler: 97.5 (5.), 106.1 (2.), 118.2 (9.)
Trefferlage: 0.07 mm rechts, 0.30 mm tief
Streuwert: 1.37, horizontal: 1.19, vertikal: 1.52

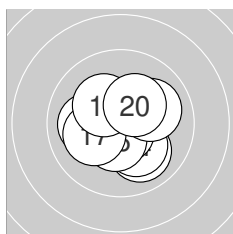

Serie 2:
 10.4 * 10.0 ↘ 10.1 ← 10.2 * 10.7 *
 10.5 * 10.1 ← 10.3 * 10.0 → 10.3 *
beste Teiler: 62.3 (15.), 124.9 (16.), 141.0 (11.)
Trefferlage: 0.13 mm links, 0.24 mm tief
Streuwert: 1.35, horizontal: 1.51, vertikal: 1.17

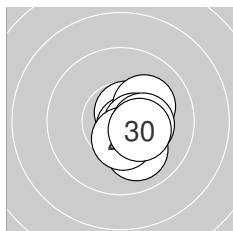

Serie 3:
 10.6 * 10.7 * 10.7 * 10.2 * 10.5 *
 10.4 * 10.0 ↘ 10.4 * 10.3 * 10.4 *
beste Teiler: 67.2 (23.), 71.3 (22.), 93.8 (21.)
Trefferlage: 0.95 mm rechts, 0.47 mm tief
Streuwert: 0.72, horizontal: 0.53, vertikal: 0.87

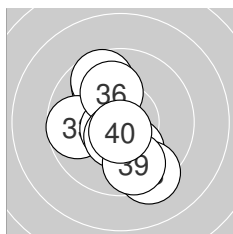

Serie 4:
 9.8 ↘ 9.7 ↘ 9.7 ← 10.6 * 10.1 ↘
 10.1 ↗ 10.5 * 9.3 ↘ 9.7 ↘ 10.7 *
beste Teiler: 68.0 (40.), 81.6 (34.), 109.7 (37.)
Trefferlage: 0.35 mm links, 0.34 mm tief
Streuwert: 1.89, horizontal: 1.42, vertikal: 2.26



Ergebnis: **406.8** (388)
 Serien: 101.0 100.8 102.5 102.5
 Zähler: 28 12 0 0 0 0 0 0 0 0
 Innenzehner: 23
 Weitester: 477 (36.), 385 (3.), 383 (8.)
 beste Teiler: 17.6 (30.), 45.9 (37.), 54.8 (34.)
 Trefferlage: 0.12 mm rechts, 0.64 mm hoch
 Streuwert: 1.51, horizontal: 1.55, vertikal: 1.46

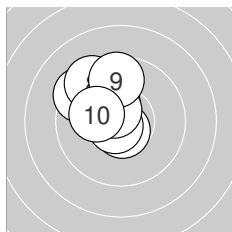
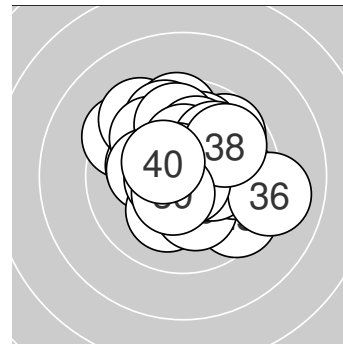

Serie 1:
 10.6 * 10.7 * 9.4 ↘ 10.4 * 10.4 *
 9.9 ↖ 10.5 * 9.4 ↘ 9.6 ↑ 10.1 ↖
 beste Teiler: 56.7 (2.), 76.4 (1.), 102.7 (7.)
 Trefferlage: 1.09 mm links, 1.36 mm hoch
 Streuwert: 1.22, horizontal: 1.05, vertikal: 1.36

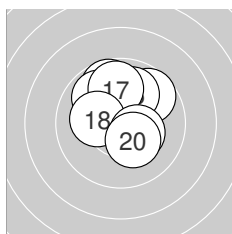

Serie 2:
 9.7 ↗ 10.5 * 10.4 * 9.7 ↖ 10.0 ↗
 9.9 ↘ 9.8 ↑ 10.2 * 10.3 * 10.3 *
 beste Teiler: 101.2 (12.), 127.0 (13.), 154.9 (19.)
 Trefferlage: 0.04 mm links, 1.22 mm hoch
 Streuwert: 1.44, horizontal: 1.39, vertikal: 1.49

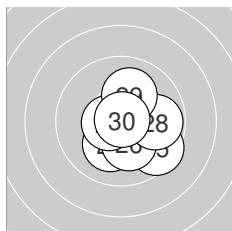

Serie 3:
 10.4 * 10.1 ↙ 10.3 * 10.6 * 9.5 ↘
 10.2 * 10.6 * 9.8 → 10.1 ↑ 10.9 *
 beste Teiler: 17.6 (30.), 92.3 (24.), 94.0 (27.)
 Trefferlage: 0.83 mm rechts, 0.43 mm tief
 Streuwert: 1.31, horizontal: 1.27, vertikal: 1.35

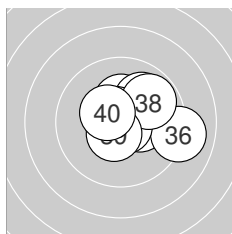

Serie 4:
 10.3 * 10.3 * 10.0 ↗ 10.7 * 10.7 *
 9.0 → 10.8 * 9.8 ↗ 10.5 * 10.4 *
 beste Teiler: 45.9 (37.), 54.8 (34.), 72.0 (35.)
 Trefferlage: 0.80 mm rechts, 0.42 mm hoch
 Streuwert: 1.44, horizontal: 1.76, vertikal: 1.04



Ergebnis: **389.7** (372)
 Serien: 95.7 98.6 98.3 97.1
 Zähler: 17 18 5 0 0 0 0 0 0 0
 Innenzehner: 15
 Weitester: 714 (24.), 674 (32.), 671 (8.)
 beste Teiler: 3.0 (36.), 39.0 (35.), 42.2 (37.)
 Trefferlage: 0.94 mm rechts, 0.25 mm hoch
 Streuwert: 2.45, horizontal: 2.96, vertikal: 1.80

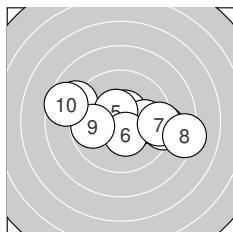
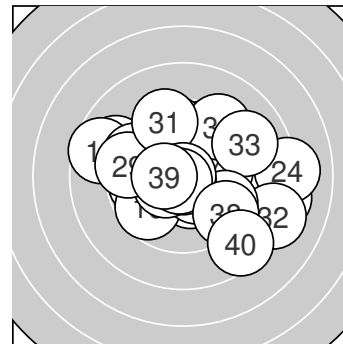

Serie 1:
 9.2 → 10.5 * 9.0 ↖ 10.0 → 10.5 *
 10.4 * 9.4 → 8.3 → 9.8 ← 8.6 ↖
 beste Teiler: 104.6 (2.), 114.0 (5.), 142.4 (6.)
 Trefferlage: 0.48 mm rechts, 0.12 mm hoch
 Streuwert: 2.95, horizontal: 3.99, vertikal: 1.21

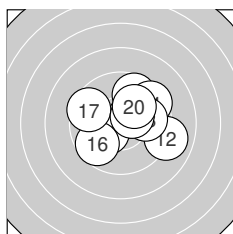

Serie 2:
 9.7 ↗ 9.0 → 10.5 * 9.5 ↗ 10.3 *
 9.7 ↙ 9.5 ↖ 9.9 → 10.4 * 10.1 ↗
 beste Teiler: 123.6 (13.), 137.2 (19.), 167.6 (15.)
 Trefferlage: 0.81 mm rechts, 0.52 mm hoch
 Streuwert: 2.09, horizontal: 2.48, vertikal: 1.62

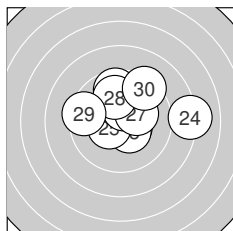

Serie 3:
 10.5 * 9.7 ↑ 10.4 * 8.1 → 10.4 *
 10.4 * 10.2 * 9.9 ↑ 9.4 ← 9.3 ↗
 beste Teiler: 116.1 (21.), 129.5 (26.), 130.5 (25.)
 Trefferlage: 0.73 mm rechts, 0.99 mm hoch
 Streuwert: 2.29, horizontal: 2.83, vertikal: 1.57

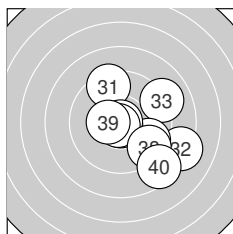

Serie 4:
 9.4 ↑ 8.3 → 9.0 ↗ 9.6 ↘ 10.8 *
 10.9 * 10.8 * 9.4 ↘ 10.4 * 8.5 ↘
 beste Teiler: 3.0 (36.), 39.0 (35.), 42.2 (37.)
 Trefferlage: 1.73 mm rechts, 0.64 mm tief
 Streuwert: 2.52, horizontal: 2.61, vertikal: 2.43



Ergebnis: **400.6** (381)
 Serien: 100.2 100.3 99.9 100.2
 Zähler: 23 15 2 0 0 0 0 0 0 0
 Innenzehner: 16
 Weitester: 613 (37.), 529 (17.), 470 (5.)
 beste Teiler: 31.0 (12.), 42.7 (14.), 49.4 (1.)
 Trefferlage: 0.74 mm rechts, 0.57 mm hoch
 Streuwert: 1.83, horizontal: 2.20, vertikal: 1.35

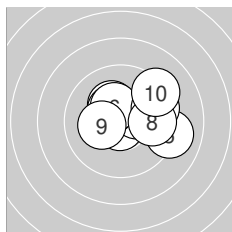
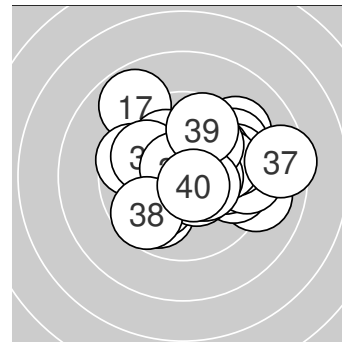

Serie 1:
 10.8 * 10.3 * 10.3 * 10.4 * 9.1 →
 10.4 * 9.6 ↗ 9.8 → 10.2 * 9.3 ↗
 beste Teiler: 49.4 (1.), 140.0 (4.), 146.9 (6.)
 Trefferlage: 1.14 mm rechts, 0.64 mm hoch
 Streuwert: 1.78, horizontal: 2.23, vertikal: 1.16

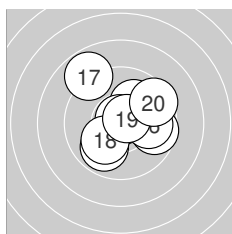

Serie 2:
 9.9 ↙ 10.8 * 10.1 ↗ 10.8 * 9.7 →
 9.9 → 8.8 ↘ 10.1 ↙ 10.7 * 9.5 ↗
 beste Teiler: 31.0 (12.), 42.7 (14.), 71.4 (19.)
 Trefferlage: 0.47 mm rechts, 0.46 mm hoch
 Streuwert: 1.99, horizontal: 2.09, vertikal: 1.90

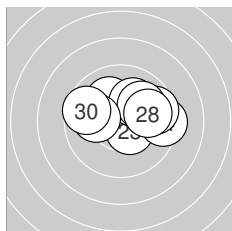

Serie 3:
 10.7 * 10.1 ↘ 10.5 * 9.4 → 10.1 ↗
 9.6 → 10.0 ↗ 9.9 → 10.0 ← 9.6 ←
 beste Teiler: 75.3 (21.), 120.9 (23.), 212.7 (25.)
 Trefferlage: 0.78 mm rechts, 0.73 mm hoch
 Streuwert: 1.76, horizontal: 2.33, vertikal: 0.88

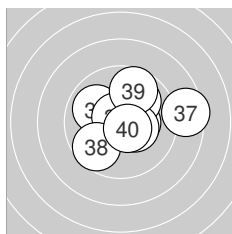

Serie 4:
 10.4 * 10.3 * 9.9 ↘ 10.0 ↗ 10.4 *
 10.7 * 8.5 → 9.7 ↙ 9.7 ↑ 10.6 *
 beste Teiler: 65.1 (36.), 87.1 (40.), 142.6 (35.)
 Trefferlage: 0.58 mm rechts, 0.46 mm hoch
 Streuwert: 2.02, horizontal: 2.45, vertikal: 1.45



Ergebnis: **388.3** (369)
Serien: 97.0 98.9 93.6 98.8
Zähler: 16 19 3 2 0 0 0 0 0 0
Innenzehner: 11
Weiteste: 931 (27.), 888 (6.), 565 (12.)
beste Teiler: 69.7 (3.), 74.8 (4.), 76.3 (37.)
Trefferlage: 0.13 mm links, 0.48 mm hoch
Streuwert: 2.60, horizontal: 3.20, vertikal: 1.83

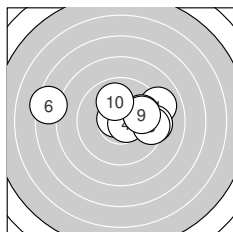
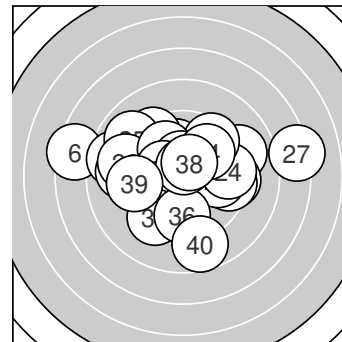

Serie 1:
 9.0 ↗ 10.5 * 10.7 * 10.7 * 9.9 ↗
 7.4 ↖ 9.4 → 9.5 → 9.9 → 10.0 ↑
beste Teiler: 69.7 (3.), 74.8 (4.), 101.8 (2.)
Trefferlage: 0.86 mm rechts, 0.77 mm hoch
Streuwert: 2.80, horizontal: 3.83, vertikal: 1.02

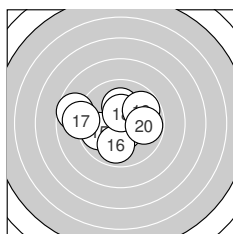

Serie 2:
 10.6 * 8.7 ↖ 10.2 * 10.5 * 9.9 ↖
 9.9 ↓ 9.0 ← 10.5 * 9.8 ↗ 9.8 →
beste Teiler: 99.7 (11.), 112.0 (14.), 122.1 (18.)
Trefferlage: 0.66 mm links, 0.18 mm hoch
Streuwert: 2.22, horizontal: 2.80, vertikal: 1.41

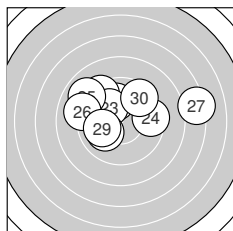

Serie 3:
 10.0 ↑ 9.3 ↘ 10.1 ↘ 9.5 → 8.9 ↘
 9.1 ↖ 7.2 → 10.0 ↙ 10.0 ← 9.5 ↗
beste Teiler: 212.5 (23.), 228.4 (28.), 237.0 (29.)
Trefferlage: 0.19 mm links, 1.42 mm hoch
Streuwert: 3.14, horizontal: 4.15, vertikal: 1.58

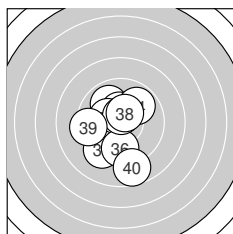

Serie 4:
 9.9 ↘ 10.4 * 10.3 * 9.9 ↗ 9.4 ↙
 9.7 ↓ 10.6 * 10.5 * 9.4 ← 8.7 ↓
beste Teiler: 76.3 (37.), 120.3 (38.), 137.9 (32.)
Trefferlage: 0.54 mm links, 0.45 mm tief
Streuwert: 2.21, horizontal: 1.74, vertikal: 2.60



Ergebnis: **394.5** (380)
 Serien: 97.6 100.5 99.0 97.4
 Zähler: 22 16 2 0 0 0 0 0 0
 Innenzehner: 12
 Weitestе: 598 (35.), 592 (5.), 461 (31.)
 beste Teiler: 71.8 (38.), 85.0 (14.), 114.5 (11.)
 Trefferlage: 0.22 mm rechts, 0.28 mm hoch
 Streuwert: 2.13, horizontal: 1.94, vertikal: 2.30

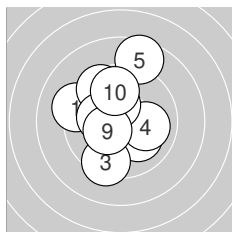
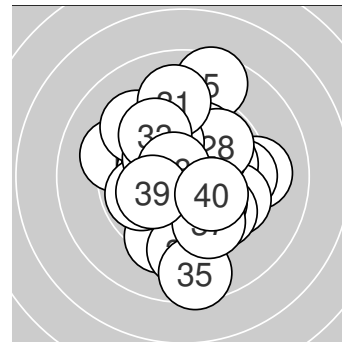

Serie 1:
 9.2 ↖ 10.1 ↘ 9.4 ↓ 10.0 → 8.6 ↑
 10.3 * 9.6 ↙ 10.2 * 10.4 * 9.8 ↑
 beste Teiler: 146.1 (9.), 156.4 (6.), 184.7 (8.)
 Trefferlage: 0.55 mm links, 0.81 mm hoch
 Streuwert: 2.33, horizontal: 1.97, vertikal: 2.64

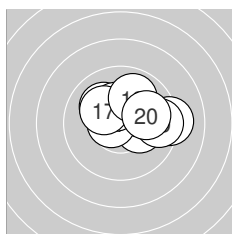

Serie 2:
 10.5 * 10.2 * 10.1 ↘ 10.6 * 9.2 →
 10.3 * 10.2 * 9.9 ↗ 9.5 → 10.0 →
 beste Teiler: 85.0 (14.), 114.5 (11.), 158.4 (16.)
 Trefferlage: 0.98 mm rechts, 0.74 mm hoch
 Streuwert: 1.60, horizontal: 2.09, vertikal: 0.87

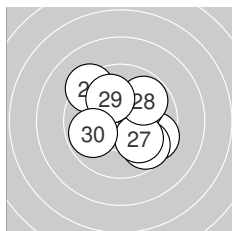

Serie 3:
 10.5 * 9.3 ↘ 10.2 * 9.6 ↘ 9.7 ↘
 10.1 ↗ 10.0 ↘ 9.8 ↗ 10.0 ↖ 9.8 ←
 beste Teiler: 123.1 (21.), 199.1 (23.), 217.4 (26.)
 Trefferlage: 0.53 mm rechts, 0.42 mm hoch
 Streuwert: 1.98, horizontal: 2.14, vertikal: 1.82

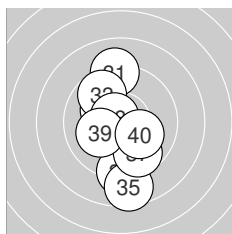

Serie 4:
 9.1 ↑ 10.2 * 9.7 ↘ 9.1 ↓ 8.6 ↓
 10.1 ↘ 9.7 ↘ 10.7 * 10.1 ↖ 10.1 ↘
 beste Teiler: 71.8 (38.), 184.2 (32.), 207.2 (40.)
 Trefferlage: 0.05 mm links, 0.82 mm tief
 Streuwert: 2.44, horizontal: 1.39, vertikal: 3.16



Ergebnis: 351.0 (334)
Serien: 92.7 86.7 82.7 88.9
Zähler: 8 11 11 7 3 0 0 0 0 0
Innenzehner: 4
Weiteste: 1124 (35.), 1093 (40.), 1075 (23.)
beste Teiler: 51.4 (24.), 65.2 (5.), 102.3 (38.)
Trefferlage: 1.86 mm links, 0.45 mm tief
Streuwert: 4.15, horizontal: 4.35, vertikal: 3.95

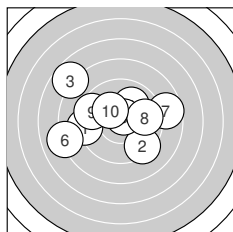
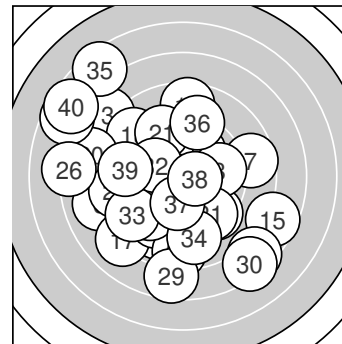

Serie 1:
 9.1 ← 9.3 ↘ 7.7 ↘ 10.0 ↗ 10.7 *
 8.0 ← 8.6 → 9.7 → 9.4 ↖ 10.2 *
beste Teiler: 65.2 (5.), 187.4 (10.), 239.6 (4.)
Trefferlage: 0.94 mm links, 0.59 mm hoch
Streuwert: 3.41, horizontal: 4.25, vertikal: 2.29

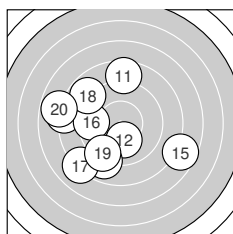

Serie 2:
 8.6 ↑ 10.1 ↓ 8.9 ↙ 8.1 ← 7.6 →
 9.5 ← 8.1 ↙ 8.8 ↘ 9.2 ↙ 7.8 ←
beste Teiler: 211.2 (12.), 363.3 (16.), 434.5 (19.)
Trefferlage: 2.34 mm links, 0.69 mm tief
Streuwert: 4.08, horizontal: 4.38, vertikal: 3.75

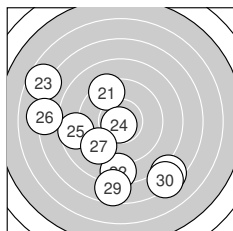

Serie 3:
 9.3 ↘ 8.5 ↓ 6.7 ↖ 10.7 * 8.7 ←
 7.2 ← 9.3 ↙ 7.4 ↘ 7.6 ↓ 7.3 ↘
beste Teiler: 51.4 (24.), 401.2 (21.), 411.5 (27.)
Trefferlage: 1.90 mm links, 2.39 mm tief
Streuwert: 4.98, horizontal: 5.31, vertikal: 4.63

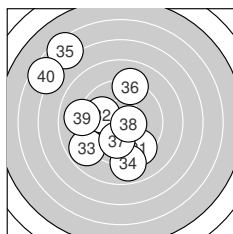

Serie 4:
 9.4 ↘ 10.0 ↖ 8.9 ↙ 8.9 ↓ 6.5 ↘
 9.1 ↑ 10.0 ↓ 10.5 * 9.0 ← 6.6 ↖
beste Teiler: 102.3 (38.), 228.6 (37.), 247.9 (32.)
Trefferlage: 2.25 mm links, 0.67 mm hoch
Streuwert: 4.19, horizontal: 3.91, vertikal: 4.46



Ergebnis: **110.6** (99)
 Serien: 56.9 53.7
 Zähler: 1 0 3 3 3 1 1 5 0 2
 Innenzehner: 1
 Weitester: 2717 (17.), 2298 (16.), 2268 (3.)
 beste Teiler: 151.9 (19.), 506.0 (4.), 523.1 (13.)
 Trefferlage: 5.65 mm rechts, 2.59 mm hoch
 Streuwert: 10.03, horizontal: 12.24, vertikal: 7.15

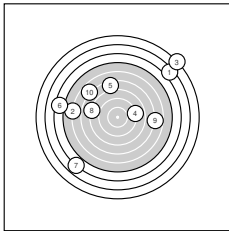
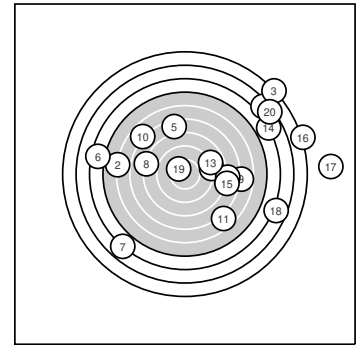

Serie 1:
 3.3 ↗ 5.9 ← 1.9 ↗ 8.9 → 7.3 ↑
 4.3 ← 3.9 ↘ 8.0 ← 6.7 → 6.7 ↘
 beste Teiler: 506.0 (4.), 743.2 (8.), 907.5 (5.)
 Trefferlage: 1.08 mm links, 3.76 mm hoch
 Streuwert: 10.17, horizontal: 11.92, vertikal: 8.06

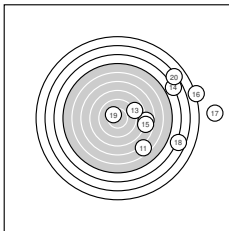

Serie 2:
 6.6 ↘ 7.8 → 8.9 ↗ 3.8 ↗ 7.8 →
 1.8 → 0.0 → 3.6 ↘ 10.3 * 3.1 ↗
 beste Teiler: 151.9 (19.), 523.1 (13.), 797.0 (12.)
 Trefferlage: 12.39 mm rechts, 1.43 mm hoch
 Streuwert: 7.53, horizontal: 8.57, vertikal: 6.32



Ergebnis: **352.3** (333)
 Serien: 82.3 93.9 90.3 85.8
 Zähler: 7 11 14 6 1 0 1 0 0 0
 Innenzehner: 6
 Weitester: 1749 (2.), 1126 (39.), 937 (1.)
 beste Teiler: 78.0 (12.), 87.8 (22.), 116.2 (8.)
 Trefferlage: 1.25 mm links, 0.56 mm hoch
 Streuwert: 4.36, horizontal: 5.40, vertikal: 2.99

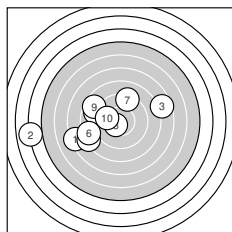
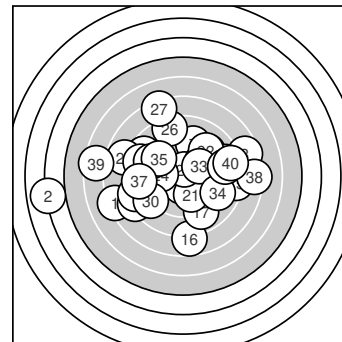

Serie 1:
 7.2 ← 4.0 ← 7.6 → 8.1 ← 8.9 ←
 8.3 ← 9.2 ↑ 10.5 * 8.6 ↘ 9.9 ←
 beste Teiler: 116.2 (8.), 268.4 (10.), 438.0 (7.)
 Trefferlage: 4.25 mm links, 0.03 mm tief
 Streuwert: 5.09, horizontal: 6.60, vertikal: 2.86

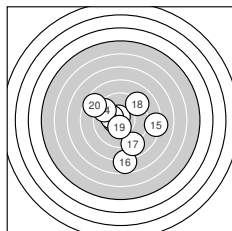

Serie 2:
 10.5 * 10.6 * 10.2 * 9.5 ↘ 8.2 →
 7.7 ↓ 8.9 ↘ 9.2 ↗ 10.4 * 8.7 ↘
 beste Teiler: 78.0 (12.), 116.7 (11.), 132.8 (19.)
 Trefferlage: 0.16 mm rechts, 0.56 mm tief
 Streuwert: 3.40, horizontal: 3.36, vertikal: 3.44

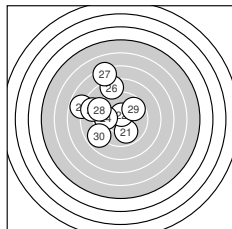

Serie 3:
 9.9 ↘ 10.6 * 7.8 ← 9.8 ← 8.7 ←
 8.4 ↑ 7.3 ↑ 9.2 ↘ 9.7 ↗ 8.9 ←
 beste Teiler: 87.8 (22.), 257.3 (21.), 286.0 (24.)
 Trefferlage: 2.50 mm links, 1.84 mm hoch
 Streuwert: 3.30, horizontal: 3.06, vertikal: 3.51

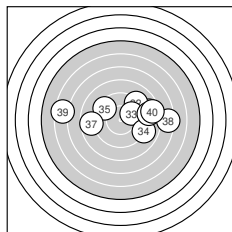

Serie 4:
 8.7 → 9.2 ↗ 10.0 ↗ 9.0 ↘ 9.4 ↘
 8.7 → 8.7 ← 7.3 → 6.4 ← 8.4 →
 beste Teiler: 246.2 (33.), 382.0 (35.), 443.3 (32.)
 Trefferlage: 1.58 mm rechts, 1.03 mm hoch
 Streuwert: 4.57, horizontal: 6.27, vertikal: 1.57



Ergebnis: **370.5** (352)
 Serien: 90.4 92.4 95.1 92.6
 Zähler: 11 13 13 3 0 0 0 0 0 0
 Innenzehner: 6
 Weitester: 998 (18.), 798 (14.), 795 (6.)
 beste Teiler: 104.4 (3.), 118.0 (25.), 155.6 (26.)
 Trefferlage: 0.58 mm links, 0.12 mm hoch
 Streuwert: 3.33, horizontal: 4.04, vertikal: 2.42

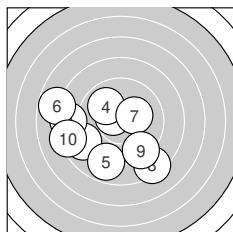
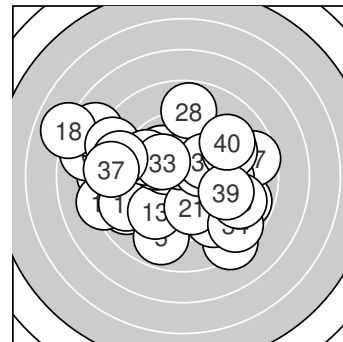

Serie 1:
 8.9 ← 8.4 ← 10.5 * 9.9 ↘ 8.9 ↓
 7.8 ↖ 10.2 * 8.3 ↘ 9.2 ↘ 8.3 ←
 beste Teiler: 104.4 (3.), 181.4 (7.), 254.6 (4.)
 Trefferlage: 2.14 mm links, 1.33 mm tief
 Streuwert: 3.43, horizontal: 4.03, vertikal: 2.69

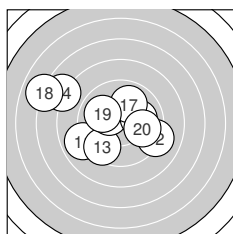

Serie 2:
 8.9 ← 9.1 → 9.5 ↗ 7.8 ↖ 10.3 *
 10.0 → 9.9 ↗ 7.0 ↖ 10.0 ↖ 9.9 →
 beste Teiler: 158.0 (15.), 227.2 (16.), 246.0 (19.)
 Trefferlage: 1.66 mm links, 0.47 mm hoch
 Streuwert: 3.51, horizontal: 4.37, vertikal: 2.34

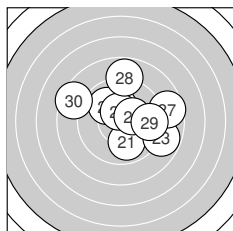

Serie 3:
 9.9 ↓ 10.2 * 8.8 → 10.0 ↘ 10.5 *
 10.3 * 8.6 → 8.8 ↑ 9.5 → 8.5 ↖
 beste Teiler: 118.0 (25.), 155.6 (26.), 182.8 (22.)
 Trefferlage: 0.89 mm rechts, 1.00 mm hoch
 Streuwert: 2.83, horizontal: 3.32, vertikal: 2.24

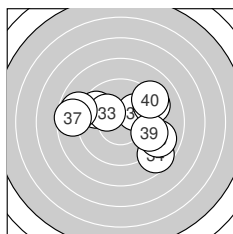

Serie 4:
 10.1 ↗ 9.6 ↖ 10.1 ↖ 8.6 ↘ 9.2 ↗
 8.8 ↖ 8.6 ← 9.0 → 9.5 → 9.1 ↗
 beste Teiler: 202.5 (33.), 215.2 (31.), 332.2 (32.)
 Trefferlage: 0.59 mm rechts, 0.34 mm hoch
 Streuwert: 3.23, horizontal: 4.07, vertikal: 2.08



Ergebnis: **375.6** (359)
 Serien: 97.4 94.9 97.5 85.8
 Zähler: 13 16 9 1 1 0 0 0 0 0
 Innenzehner: 7
 Weitester: 1096 (39.), 915 (32.), 715 (33.)
 beste Teiler: 22.6 (3.), 112.4 (2.), 118.1 (25.)
 Trefferlage: 1.77 mm links, 1.10 mm tief
 Streuwert: 2.85, horizontal: 3.55, vertikal: 1.92

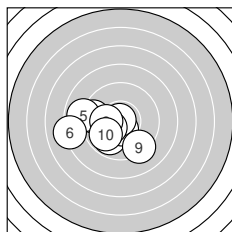
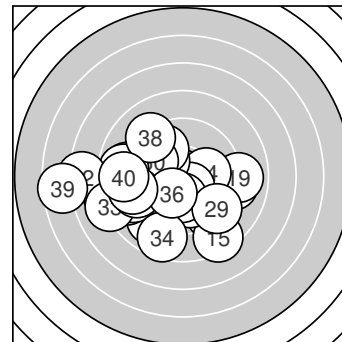

Serie 1:
 9.9 ↙ 10.5 * 10.9 * 9.5 ← 8.9 ←
 8.1 ← 10.3 * 10.2 * 9.2 ↘ 9.9 ↗
 beste Teiler: 22.6 (3.), 112.4 (2.), 161.2 (7.)
 Trefferlage: 1.99 mm links, 0.93 mm tief
 Streuwert: 2.14, horizontal: 2.70, vertikal: 1.37

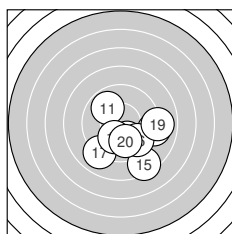

Serie 2:
 9.9 ↘ 9.1 → 9.7 ↘ 10.1 ↘ 8.4 ↘
 9.7 ↘ 9.0 ↙ 10.1 ↙ 8.9 → 10.0 ↘
 beste Teiler: 206.8 (18.), 215.7 (14.), 250.5 (20.)
 Trefferlage: 1.29 mm rechts, 1.94 mm tief
 Streuwert: 2.35, horizontal: 2.60, vertikal: 2.06

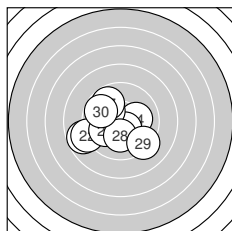

Serie 3:
 8.7 ← 9.0 ← 10.0 ← 10.1 → 10.5 *
 10.1 ↘ 9.8 ↘ 10.2 * 9.3 ↘ 9.8 ↗
 beste Teiler: 118.1 (25.), 195.1 (28.), 212.2 (24.)
 Trefferlage: 1.19 mm links, 0.57 mm tief
 Streuwert: 2.27, horizontal: 2.65, vertikal: 1.82

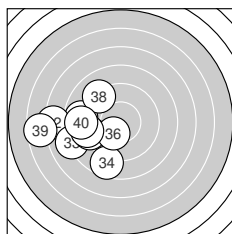

Serie 4:
 8.8 ← 7.3 ← 8.1 ← 8.6 ↙ 9.2 ←
 10.2 * 9.1 ← 9.1 ↘ 6.6 ← 8.8 ←
 beste Teiler: 181.6 (36.), 444.7 (35.), 456.3 (38.)
 Trefferlage: 5.19 mm links, 0.95 mm tief
 Streuwert: 2.73, horizontal: 3.08, vertikal: 2.33



Ergebnis: **372.8** (357)
 Serien: 95.0 93.6 90.8 93.4
 Zähler: 14 14 9 1 2 0 0 0 0 0
 Innenzehner: 10
 Weitester: 1115 (15.), 1036 (33.), 965 (19.)
 beste Teiler: 18.8 (17.), 89.3 (35.), 99.0 (3.)
 Trefferlage: 0.87 mm rechts, 0.73 mm hoch
 Streuwert: 3.36, horizontal: 3.73, vertikal: 2.93

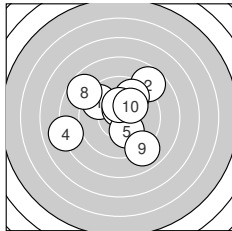
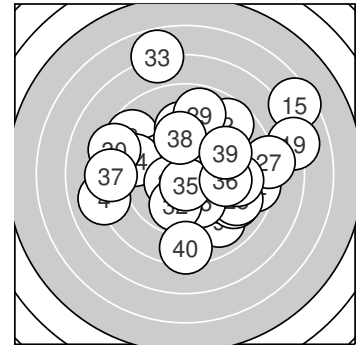

Serie 1:

9.6 ↘	8.7 ↗	10.6 *	8.1 ←	10.2 *
9.7 ↗	10.3 *	8.7 ↘	9.0 ↘	10.1 ↗

beste Teiler: 99.0 (3.), 157.0 (7.), 194.5 (5.)
 Trefferlage: 0.36 mm links, 0.83 mm hoch
 Streuwert: 3.01, horizontal: 3.35, vertikal: 2.62

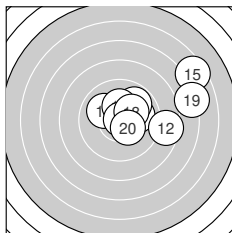

Serie 2:

10.0 →	8.5 →	10.0 ↘	9.8 ↗	6.5 ↗
10.2 *	10.9 *	10.2 *	7.1 →	10.4 *

beste Teiler: 18.8 (17.), 143.0 (20.), 179.0 (16.)
 Trefferlage: 2.95 mm rechts, 1.34 mm hoch
 Streuwert: 3.13, horizontal: 3.94, vertikal: 2.02

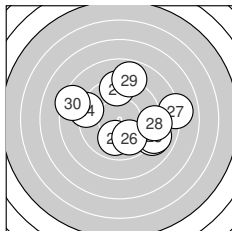

Serie 3:

9.4 ↑	10.0 ↓	9.0 ↘	9.2 ←	9.0 →
9.9 ↘	8.0 →	9.1 →	8.8 ↑	8.4 ←

beste Teiler: 247.6 (22.), 266.1 (26.), 397.5 (21.)
 Trefferlage: 1.15 mm rechts, 0.35 mm hoch
 Streuwert: 3.53, horizontal: 4.14, vertikal: 2.78

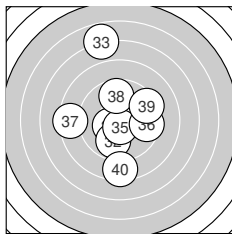

Serie 4:

10.4 *	9.9 ↓	6.8 ↑	10.3 *	10.6 *
9.5 →	8.4 ←	9.7 ↑	9.4 ↗	8.4 ↓

beste Teiler: 89.3 (35.), 143.6 (31.), 174.7 (34.)
 Trefferlage: 0.23 mm links, 0.40 mm hoch
 Streuwert: 3.63, horizontal: 2.89, vertikal: 4.24



Ergebnis: **385.7** (370)
 Serien: 97.8 93.3 98.7 95.9
 Zähler: 14 23 2 1 0 0 0 0 0 0
 Innenzehner: 7
 Weitester: 799 (20.), 665 (26.), 556 (31.)
 beste Teiler: 11.4 (7.), 60.2 (10.), 70.5 (27.)
 Trefferlage: 0.65 mm links, 1.28 mm tief
 Streuwert: 2.40, horizontal: 2.47, vertikal: 2.33

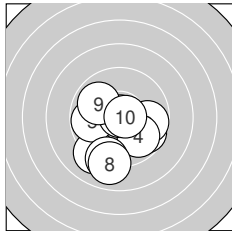
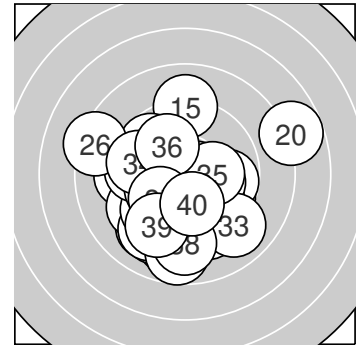

Serie 1:

9.7 ↘	9.8 →	9.1 ✓	9.8 ↘	9.8 ←
9.1 ↓	10.9 *	9.0 ↓	9.9 ↖	10.7 *

beste Teiler: 11.4 (7.), 60.2 (10.), 264.0 (9.)
 Trefferlage: 0.18 mm links, 1.56 mm tief
 Streuwert: 2.15, horizontal: 2.18, vertikal: 2.12

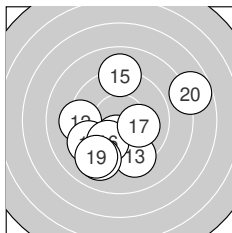

Serie 2:

10.3 *	9.3 ←	9.3 ↓	9.3 ✓	9.1 ↑
9.9 ✓	10.1 →	9.1 ✓	9.1 ✓	7.8 →

beste Teiler: 174.3 (11.), 209.2 (17.), 259.1 (16.)
 Trefferlage: 0.24 mm links, 1.10 mm tief
 Streuwert: 3.16, horizontal: 3.36, vertikal: 2.94

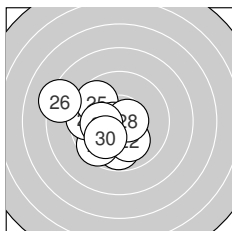

Serie 3:

9.8 ↓	10.1 ↓	9.6 ✓	9.6 ←	9.7 ↖
8.3 ↖	10.7 *	10.6 *	10.2 *	10.1 ✓

beste Teiler: 70.5 (27.), 82.2 (28.), 193.8 (29.)
 Trefferlage: 1.68 mm links, 0.50 mm tief
 Streuwert: 1.97, horizontal: 2.16, vertikal: 1.75

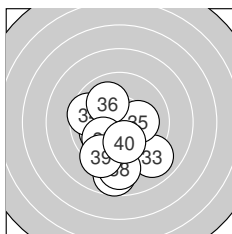

Serie 4:

8.7 ↓	10.0 ↖	9.0 ↘	9.6 ↖	10.2 *
10.0 ↖	10.0 ✓	9.0 ↓	9.3 ✓	10.1 ↓

beste Teiler: 194.0 (35.), 214.8 (40.), 226.7 (32.)
 Trefferlage: 0.49 mm links, 1.95 mm tief
 Streuwert: 2.25, horizontal: 2.02, vertikal: 2.46



Ergebnis: **405.3** (389)
 Serien: 102.8 101.0 98.0 103.5
 Zähler: 31 7 2 0 0 0 0 0 0
 Innenzehner: 23
 Weitesten: 653 (27.), 517 (14.), 444 (23.)
 beste Teiler: 32.3 (9.), 56.3 (34.), 56.8 (1.)
 Trefferlage: 0.03 mm rechts, 0.55 mm tief
 Streuwert: 1.68, horizontal: 1.96, vertikal: 1.33

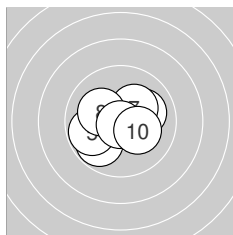
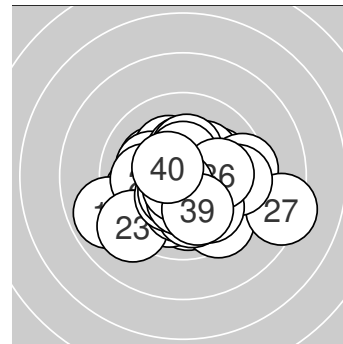

Serie 1:
 10.7 * 10.3 * 9.8 ↙ 10.7 * 9.8 ↙
 10.1 → 10.2 * 10.2 * 10.8 * 10.2 *
 beste Teiler: 32.3 (9.), 56.8 (1.), 68.6 (4.)
 Trefferlage: 0.30 mm links, 0.19 mm tief
 Streuwert: 1.37, horizontal: 1.65, vertikal: 1.00

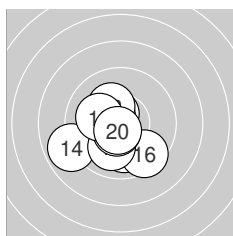

Serie 2:
 10.5 * 10.5 * 10.2 * 8.9 ↙ 10.0 ↓
 9.5 ↘ 10.0 ↓ 10.6 * 10.1 ↖ 10.7 *
 beste Teiler: 73.5 (20.), 92.3 (18.), 102.9 (11.)
 Trefferlage: 0.78 mm links, 0.76 mm tief
 Streuwert: 1.68, horizontal: 1.74, vertikal: 1.62

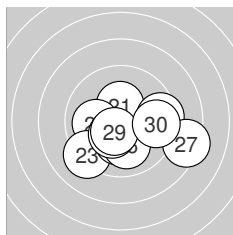

Serie 3:
 10.4 * 10.0 ← 9.2 ↙ 9.4 → 10.2 *
 10.0 ↓ 8.3 → 10.4 * 10.5 * 9.6 →
 beste Teiler: 113.0 (29.), 147.0 (28.), 150.0 (21.)
 Trefferlage: 0.67 mm rechts, 1.00 mm tief
 Streuwert: 2.28, horizontal: 2.90, vertikal: 1.40

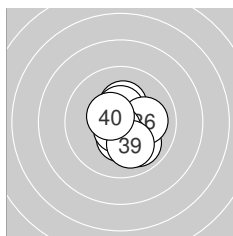

Serie 4:
 10.4 * 10.3 * 9.9 ↘ 10.7 * 10.5 *
 10.1 → 10.4 * 10.7 * 10.0 ↓ 10.5 *
 beste Teiler: 56.3 (34.), 71.5 (38.), 110.6 (40.)
 Trefferlage: 0.54 mm rechts, 0.25 mm tief
 Streuwert: 1.13, horizontal: 0.96, vertikal: 1.27



Ergebnis: **412.2** (395)
 Serien: 102.6 102.5 102.9 104.2
 Zähler: 35 5 0 0 0 0 0 0 0 0
 Innenzehner: 30
 Weitestе: 358 (23.), 355 (20.), 272 (9.)
 beste Teiler: 41.4 (12.), 46.0 (36.), 57.4 (35.)
 Trefferlage: 0.13 mm links, 0.15 mm hoch
 Streuwert: 1.28, horizontal: 1.31, vertikal: 1.25

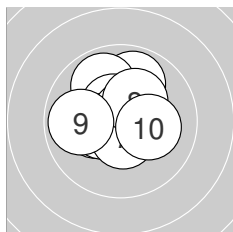
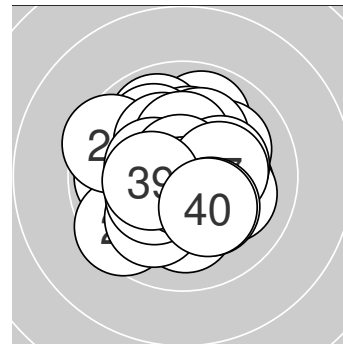

Serie 1:
 9.9 ↗ 9.9 ↘ 10.3 * 10.5 * 10.4 *
 10.7 * 10.5 * 10.3 * 9.9 ← 10.2 *
 beste Teiler: 62.1 (6.), 103.4 (7.), 110.9 (4.)
 Trefferlage: 0.31 mm links, 0.57 mm hoch
 Streuwert: 1.32, horizontal: 1.41, vertikal: 1.23

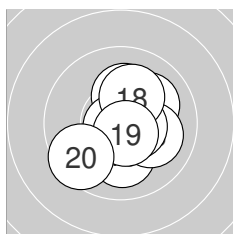

Serie 2:
 10.2 * 10.8 * 10.3 * 10.1 ↗ 10.1 ↓
 10.1 ↘ 10.6 * 10.2 * 10.6 * 9.5 ↙
 beste Teiler: 41.4 (12.), 77.8 (19.), 97.7 (17.)
 Trefferlage: 0.44 mm rechts, 0.03 mm tief
 Streuwert: 1.43, horizontal: 1.33, vertikal: 1.52

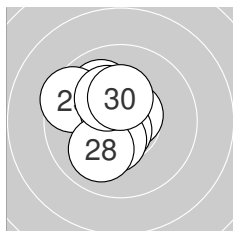

Serie 3:
 10.0 ↘ 10.6 * 9.5 ↖ 10.6 * 10.6 *
 10.7 * 10.4 * 10.0 ↙ 10.2 * 10.3 *
 beste Teiler: 62.9 (26.), 79.4 (22.), 79.6 (25.)
 Trefferlage: 0.77 mm links, 0.33 mm hoch
 Streuwert: 1.23, horizontal: 1.07, vertikal: 1.37

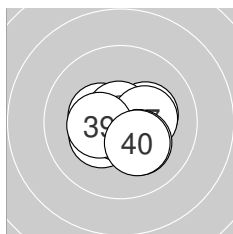

Serie 4:
 10.7 * 10.3 * 10.2 * 10.4 * 10.7 *
 10.8 * 10.3 * 10.2 * 10.4 * 10.2 *
 beste Teiler: 46.0 (36.), 57.4 (35.), 61.2 (31.)
 Trefferlage: 0.09 mm rechts, 0.26 mm tief
 Streuwert: 1.04, horizontal: 1.26, vertikal: 0.75



Ergebnis: **405.0** (387)
 Serien: 100.1 101.8 102.3 100.8
 Zähler: 27 13 0 0 0 0 0 0 0
 Innenzehner: 19
 Weitesten: 466 (6.), 414 (28.), 384 (31.)
 beste Teiler: 17.0 (30.), 35.2 (23.), 43.0 (1.)
 Trefferlage: 0.01 mm rechts, 0.31 mm tief
 Streuwert: 1.65, horizontal: 1.60, vertikal: 1.69

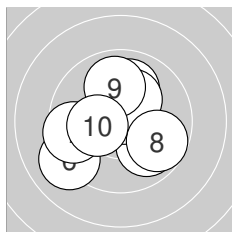
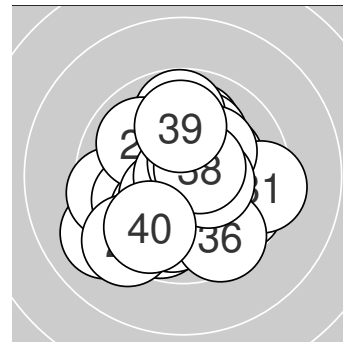

Serie 1:
 10.8 * 10.0 ↑ 9.9 ↘ 10.7 * 10.2 *
 9.1 ↙ 9.5 ← 9.7 ↘ 9.9 ↑ 10.3 *
 beste Teiler: 43.0 (1.), 62.1 (4.), 172.9 (10.)
 Trefferlage: 0.26 mm links, 0.01 mm tief
 Streuwert: 1.95, horizontal: 2.12, vertikal: 1.77

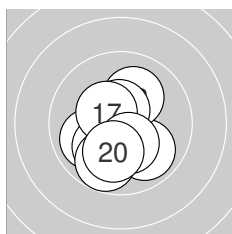

Serie 2:
 9.9 ↘ 10.0 ↙ 10.1 ↑ 10.5 * 10.1 ↙
 10.6 * 10.4 * 10.3 * 9.8 ↓ 10.1 ↓
 beste Teiler: 95.5 (16.), 118.5 (14.), 131.6 (17.)
 Trefferlage: 0.35 mm links, 0.84 mm tief
 Streuwert: 1.37, horizontal: 1.18, vertikal: 1.53

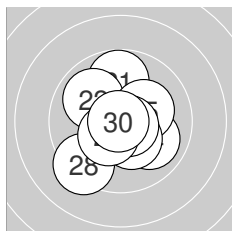

Serie 3:
 9.8 ↑ 9.9 ↘ 10.8 * 10.0 ↘ 10.2 *
 10.3 * 10.7 * 9.3 ↙ 10.4 * 10.9 *
 beste Teiler: 17.0 (30.), 35.2 (23.), 64.3 (27.)
 Trefferlage: 0.07 mm links, 0.20 mm tief
 Streuwert: 1.60, horizontal: 1.50, vertikal: 1.70

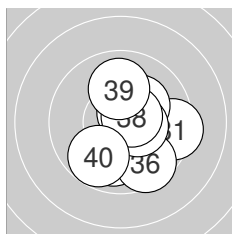

Serie 4:
 9.4 → 10.0 ↓ 10.2 * 10.6 * 10.2 *
 9.6 ↘ 10.4 * 10.6 * 10.0 ↑ 9.8 ↙
 beste Teiler: 85.0 (34.), 92.1 (38.), 128.3 (37.)
 Trefferlage: 0.75 mm rechts, 0.20 mm tief
 Streuwert: 1.69, horizontal: 1.47, vertikal: 1.89



Ergebnis: **381.7** (366)
 Serien: 91.7 94.9 98.3 96.8
 Zähler: 13 21 5 1 0 0 0 0 0 0
 Innenzehner: 9
 Weitestе: 917 (5.), 689 (7.), 633 (16.)
 beste Teiler: 57.0 (28.), 130.1 (29.), 133.4 (27.)
 Trefferlage: 0.10 mm links, 0.42 mm hoch
 Streuwert: 2.79, horizontal: 3.38, vertikal: 2.04

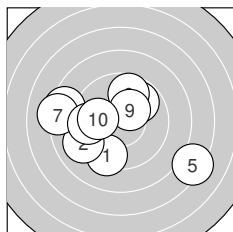
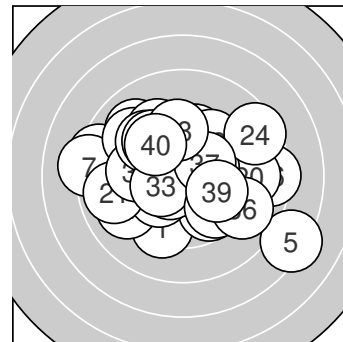

Serie 1:
 9.4 ↙ 9.1 ↖ 8.4 ← 9.8 ↗ 7.3 ↘
 9.7 ↑ 8.2 ← 9.5 ← 10.3 * 10.0 ←
 beste Teiler: 159.1 (9.), 247.3 (10.), 285.0 (4.)
 Trefferlage: 1.28 mm links, 0.21 mm tief
 Streuwert: 3.59, horizontal: 4.38, vertikal: 2.55

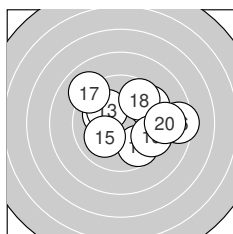

Serie 2:
 10.1 ↖ 9.5 ↗ 10.1 ↖ 9.7 ↘ 10.0 ↗
 8.4 → 9.0 ↘ 9.6 ↗ 9.5 ↘ 9.0 →
 beste Teiler: 205.7 (13.), 212.0 (11.), 226.3 (15.)
 Trefferlage: 1.30 mm rechts, 0.49 mm hoch
 Streuwert: 2.67, horizontal: 3.27, vertikal: 1.89

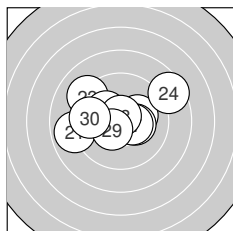

Serie 3:
 8.9 ← 10.2 * 9.1 ↖ 8.5 ↗ 10.3 *
 10.2 * 10.4 * 10.7 * 10.4 * 9.6 ←
 beste Teiler: 57.0 (28.), 130.1 (29.), 133.4 (27.)
 Trefferlage: 0.45 mm links, 0.56 mm hoch
 Streuwert: 2.40, horizontal: 3.09, vertikal: 1.42

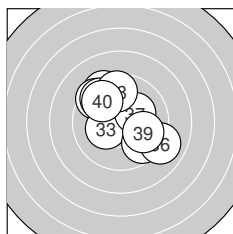

Serie 4:
 9.4 ↖ 9.5 ↖ 10.3 * 9.6 ↖ 9.6 ↘
 9.0 ↘ 10.2 * 9.6 ↑ 9.9 ↘ 9.7 ↖
 beste Teiler: 173.3 (33.), 186.7 (37.), 269.9 (39.)
 Trefferlage: 0.00 mm , 0.87 mm hoch
 Streuwert: 2.37, horizontal: 2.47, vertikal: 2.27



Ergebnis: **397.2** (382)
 Serien: 100.9 98.5 100.4 97.4
 Zähler: 23 16 1 0 0 0 0 0 0 0
 Innenzehner: 13
 Weitestе: 523 (38.), 488 (15.), 472 (35.)
 beste Teiler: 35.3 (22.), 111.0 (10.), 111.0 (26.)
 Trefferlage: 0.37 mm links, 0.34 mm hoch
 Streuwert: 1.97, horizontal: 2.29, vertikal: 1.60

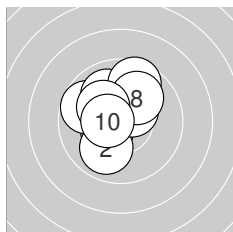
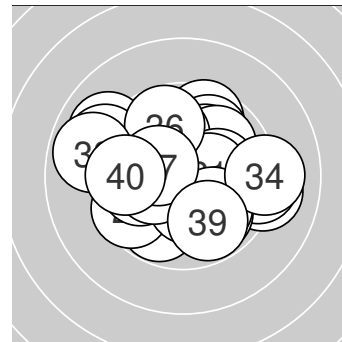

Serie 1:
 10.4 * 9.9 ↙ 10.2 * 10.4 * 9.7 ↖
 10.0 ↘ 9.6 ↑ 10.0 ↗ 10.2 * 10.5 *
 beste Teiler: 111.0 (10.), 132.2 (4.), 135.3 (1.)
 Trefferlage: 0.54 mm links, 0.96 mm hoch
 Streuwert: 1.47, horizontal: 1.36, vertikal: 1.57

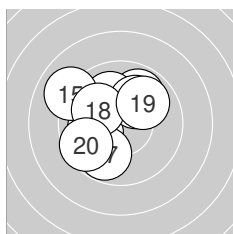

Serie 2:
 10.0 ← 9.9 ↗ 10.0 ↖ 10.1 ← 9.0 ↖
 10.1 ↗ 9.8 ↘ 10.1 ↘ 9.9 ↗ 9.6 ↖
 beste Teiler: 216.8 (14.), 218.3 (16.), 221.0 (18.)
 Trefferlage: 1.09 mm links, 0.58 mm hoch
 Streuwert: 1.93, horizontal: 2.02, vertikal: 1.85

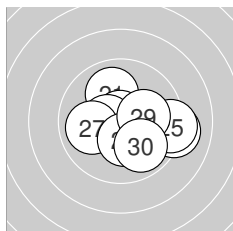

Serie 3:
 10.0 ↖ 10.8 * 9.1 → 10.3 * 9.3 →
 10.5 * 10.0 ← 10.3 * 10.2 * 9.9 ↘
 beste Teiler: 35.3 (22.), 111.0 (26.), 158.6 (28.)
 Trefferlage: 0.91 mm rechts, 0.38 mm tief
 Streuwert: 1.80, horizontal: 2.22, vertikal: 1.25

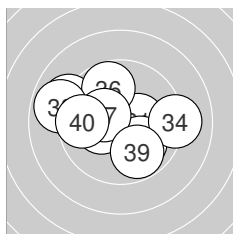

Serie 4:
 10.4 * 10.3 * 10.0 ↘ 9.1 → 9.1 ↖
 9.7 ↖ 10.4 * 8.9 ← 9.8 ↘ 9.7 ←
 beste Teiler: 147.9 (31.), 150.0 (37.), 167.1 (32.)
 Trefferlage: 0.75 mm links, 0.21 mm hoch
 Streuwert: 2.42, horizontal: 3.04, vertikal: 1.58



Ergebnis: **395.4** (376)
 Serien: 97.7 96.7 100.7 100.3
 Zähler: 18 20 2 0 0 0 0 0 0
 Innenzehner: 14
 Weitester: 569 (14.), 560 (2.), 461 (32.)
 beste Teiler: 16.5 (20.), 63.3 (31.), 71.6 (40.)
 Trefferlage: 0.27 mm links, 0.95 mm hoch
 Streuwert: 2.02, horizontal: 2.29, vertikal: 1.72

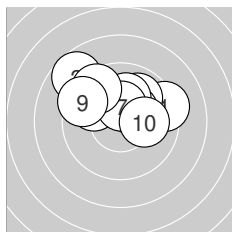
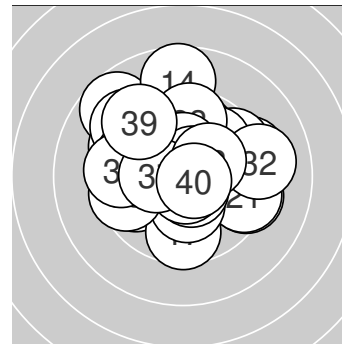

Serie 1:
 9.3 → 8.7 ↘ 9.9 ↗ 10.4 * 10.1 ↑
 9.9 ↖ 10.4 * 9.5 ↘ 9.4 ↖ 10.1 →
 beste Teiler: 136.2 (7.), 149.9 (4.), 213.1 (10.)
 Trefferlage: 0.26 mm links, 1.78 mm hoch
 Streuwert: 1.99, horizontal: 2.60, vertikal: 1.10

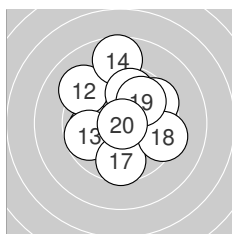

Serie 2:
 9.9 ← 9.2 ↘ 9.7 ← 8.7 ↑ 9.8 ↑
 9.6 ↗ 9.6 ↓ 9.4 → 9.9 ↗ 10.9 *
 beste Teiler: 16.5 (20.), 251.2 (11.), 268.8 (19.)
 Trefferlage: 0.07 mm rechts, 0.89 mm hoch
 Streuwert: 2.52, horizontal: 2.41, vertikal: 2.62

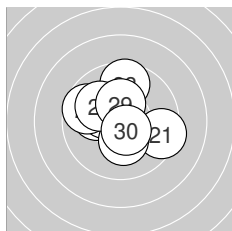

Serie 3:
 9.4 → 10.1 ← 9.6 ↑ 10.3 * 10.3 *
 10.4 * 9.7 ↖ 10.0 ↘ 10.3 * 10.6 *
 beste Teiler: 95.1 (30.), 145.0 (26.), 156.0 (24.)
 Trefferlage: 0.37 mm links, 0.63 mm hoch
 Streuwert: 1.70, horizontal: 1.87, vertikal: 1.50

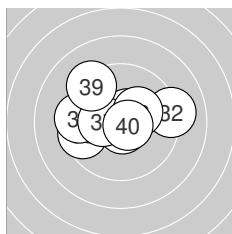

Serie 4:
 10.7 * 9.1 → 9.5 ← 10.4 * 9.5 ←
 10.6 * 10.3 * 10.2 * 9.3 ↘ 10.7 *
 beste Teiler: 63.3 (31.), 71.6 (40.), 96.0 (36.)
 Trefferlage: 0.51 mm links, 0.49 mm hoch
 Streuwert: 1.97, horizontal: 2.53, vertikal: 1.17



Ergebnis: **406.8** (389)
Serien: 101.8 101.0 101.4 102.6
Zähler: 30 9 1 0 0 0 0 0 0 0
Innenzehner: 22
Weiteste: 543 (12.), 443 (28.), 325 (9.)
beste Teiler: 25.0 (24.), 29.2 (19.), 34.9 (22.)
Trefferlage: 0.37 mm links, 0.48 mm hoch
Streuwert: 1.56, horizontal: 1.85, vertikal: 1.19

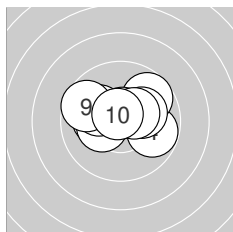
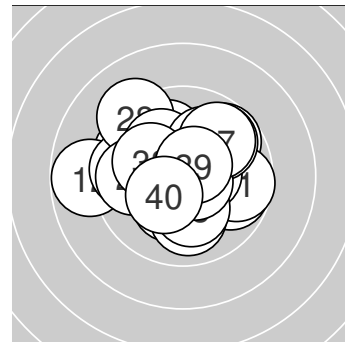

Serie 1:
 10.2 * 10.3 * 10.1 ↖ 9.8 → 9.7 ↗
 10.7 * 10.2 * 10.4 * 9.7 ↖ 10.7 *
beste Teiler: 68.5 (10.), 74.7 (6.), 136.6 (8.)
Trefferlage: 0.04 mm links, 0.59 mm hoch
Streuwert: 1.55, horizontal: 2.03, vertikal: 0.83

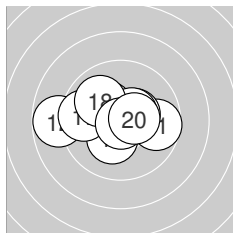

Serie 2:
 9.7 → 8.8 ← 10.3 * 10.3 * 10.4 *
 10.5 * 9.7 ← 10.0 ↘ 10.8 * 10.5 *
beste Teiler: 29.2 (19.), 113.5 (16.), 119.9 (20.)
Trefferlage: 0.57 mm links, 0.21 mm hoch
Streuwert: 1.86, horizontal: 2.48, vertikal: 0.90

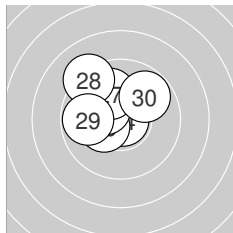

Serie 3:
 10.1 ↖ 10.8 * 10.2 * 10.9 * 10.3 *
 10.3 * 10.0 ↘ 9.2 ↘ 9.8 ← 9.8 ↗
beste Teiler: 25.0 (24.), 34.9 (22.), 157.5 (25.)
Trefferlage: 1.05 mm links, 0.97 mm hoch
Streuwert: 1.40, horizontal: 1.48, vertikal: 1.31

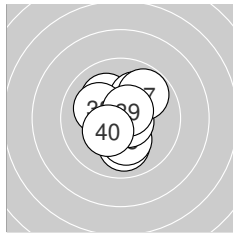

Serie 4:
 10.0 ↓ 10.7 * 10.2 * 10.1 ↘ 10.7 *
 10.1 ↗ 9.8 ↗ 10.1 ↖ 10.6 * 10.3 *
beste Teiler: 68.2 (32.), 74.2 (35.), 90.5 (39.)
Trefferlage: 0.16 mm rechts, 0.17 mm hoch
Streuwert: 1.39, horizontal: 1.20, vertikal: 1.56



Ergebnis: **409.2** (392)
 Serien: 103.6 100.1 102.9 102.6
 Zähler: 32 8 0 0 0 0 0 0 0 0
 Innenzehner: 23
 Weitest: 367 (20.), 305 (16.), 305 (26.)
 beste Teiler: 45.0 (28.), 49.8 (10.), 55.9 (35.)
 Trefferlage: 0.11 mm rechts, 0.07 mm tief
 Streuwert: 1.40, horizontal: 1.47, vertikal: 1.33

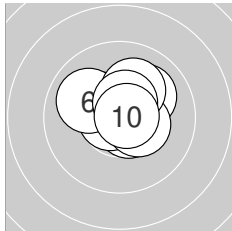
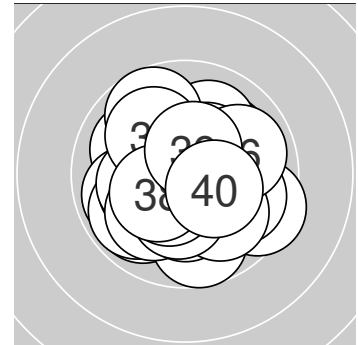

Serie 1:

10.3 *	10.1 ↗	10.1 ↗	10.6 *	10.7 *
10.0 ↖	10.4 *	10.1 ↗	10.5 *	10.8 *

beste Teiler: 49.8 (10.), 63.2 (5.), 86.3 (4.)
 Trefferlage: 0.22 mm rechts, 0.70 mm hoch
 Streuwert: 1.08, horizontal: 1.23, vertikal: 0.91

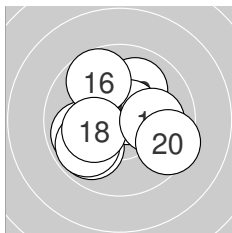

Serie 2:

9.9 ↙	10.0 ↗	9.9 ↙	10.4 *	10.6 *
9.7 ↘	9.8 ↙	10.2 *	10.1 →	9.5 ↘

beste Teiler: 82.8 (15.), 149.2 (14.), 188.3 (18.)
 Trefferlage: 0.34 mm links, 0.01 mm tief
 Streuwert: 1.84, horizontal: 2.04, vertikal: 1.61

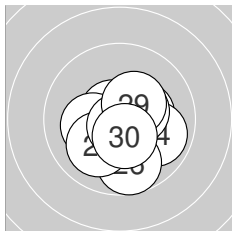

Serie 3:

10.7 *	10.3 *	10.2 *	9.9 ↘	10.4 *
9.7 ↓	10.0 ↙	10.8 *	10.4 *	10.5 *

beste Teiler: 45.0 (28.), 68.6 (21.), 122.1 (30.)
 Trefferlage: 0.33 mm rechts, 0.53 mm tief
 Streuwert: 1.28, horizontal: 1.33, vertikal: 1.23

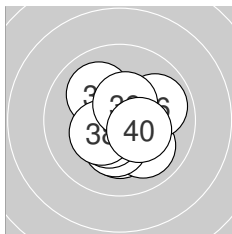

Serie 4:

10.2 *	10.0 ↘	10.0 ↘	10.3 *	10.7 *
9.9 →	10.4 *	10.3 *	10.5 *	10.3 *

beste Teiler: 55.9 (35.), 116.7 (39.), 128.9 (37.)
 Trefferlage: 0.23 mm rechts, 0.45 mm tief
 Streuwert: 1.28, horizontal: 1.26, vertikal: 1.29



Ergebnis: **394.0** (377)
 Serien: 99.3 98.2 99.3 97.2
 Zähler: 18 21 1 0 0 0 0 0 0
 Innenzehner: 14
 Weitester: 561 (39.), 499 (4.), 450 (11.)
 beste Teiler: 26.3 (6.), 71.7 (22.), 94.8 (33.)
 Trefferlage: 0.33 mm links, 0.41 mm hoch
 Streuwert: 2.14, horizontal: 2.10, vertikal: 2.19

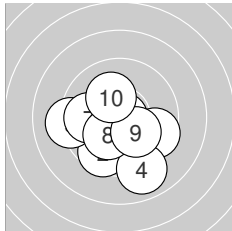
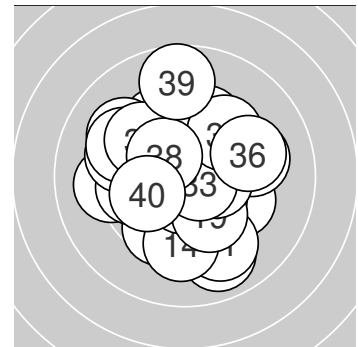

Serie 1:

9.6 ↘	9.6 ↙	10.6 *	9.0 ↘	9.2 ←
10.8 *	9.9 ←	10.2 *	10.2 *	10.2 *

beste Teiler: 26.3 (6.), 98.2 (3.), 183.8 (8.)
 Trefferlage: 0.29 mm links, 1.15 mm tief
 Streuwert: 2.01, horizontal: 2.25, vertikal: 1.74

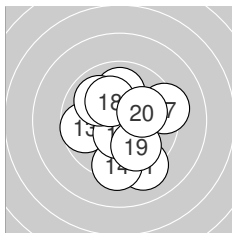

Serie 2:

9.2 ↘	10.0 ↑	9.7 ←	9.4 ↓	10.5 *
9.9 ↘	9.3 →	10.2 *	9.9 ↘	10.1 →

beste Teiler: 118.6 (15.), 187.8 (18.), 213.2 (20.)
 Trefferlage: 0.34 mm rechts, 0.44 mm tief
 Streuwert: 2.22, horizontal: 2.07, vertikal: 2.36

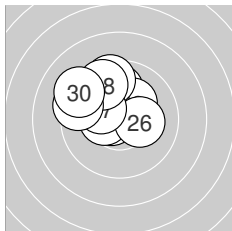

Serie 3:

9.9 ↑	10.7 *	10.2 *	10.4 *	9.5 ↑
10.2 *	10.2 *	9.6 ↘	9.4 ↖	9.2 ↘

beste Teiler: 71.7 (22.), 135.2 (24.), 180.7 (26.)
 Trefferlage: 1.05 mm links, 1.47 mm hoch
 Streuwert: 1.58, horizontal: 1.76, vertikal: 1.38

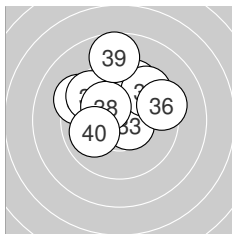

Serie 4:

10.1 ↘	9.6 ↗	10.6 *	9.3 ↖	9.6 ↗
9.4 →	9.6 ↘	10.3 *	8.7 ↑	10.0 ←

beste Teiler: 94.8 (33.), 171.1 (38.), 218.0 (31.)
 Trefferlage: 0.34 mm links, 1.78 mm hoch
 Streuwert: 2.11, horizontal: 2.35, vertikal: 1.84



Ergebnis: **391.4** (375)
 Serien: 96.0 99.4 99.5 96.5
 Zähler: 19 17 4 0 0 0 0 0 0
 Innenzehner: 14
 Weitesten: 635 (39.), 614 (6.), 612 (9.)
 beste Teiler: 63.3 (22.), 70.2 (7.), 77.8 (23.)
 Trefferlage: 0.11 mm links, 0.57 mm hoch
 Streuwert: 2.32, horizontal: 2.27, vertikal: 2.36

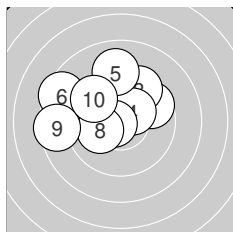
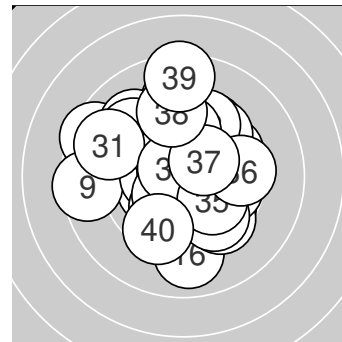

Serie 1:
 10.0 ↗ 9.6 ↗ 9.5 ↗ 10.4 * 9.1 ↑
 8.5 ↖ 10.7 * 10.1 ← 8.5 ← 9.6 ↖
 beste Teiler: 70.2 (7.), 147.8 (4.), 212.8 (8.)
 Trefferlage: 0.96 mm links, 1.46 mm hoch
 Streuwert: 2.52, horizontal: 3.10, vertikal: 1.74

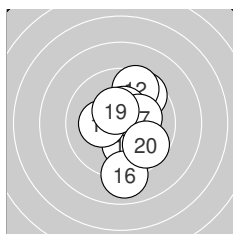

Serie 2:
 9.6 ↗ 9.5 ↗ 10.3 * 10.1 ↓ 10.4 *
 9.0 ↓ 10.2 * 10.2 * 10.4 * 9.7 ↘
 beste Teiler: 128.6 (19.), 131.7 (15.), 154.3 (13.)
 Trefferlage: 0.73 mm rechts, 0.14 mm tief
 Streuwert: 1.97, horizontal: 1.28, vertikal: 2.47

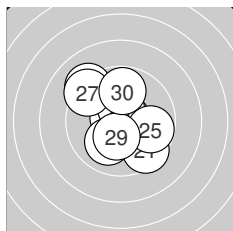

Serie 3:
 9.5 ↘ 10.7 * 10.6 * 10.4 * 9.8 →
 9.1 ↖ 9.3 ↖ 10.0 ↙ 10.3 * 9.8 ↑
 beste Teiler: 63.3 (22.), 77.8 (23.), 129.0 (24.)
 Trefferlage: 0.25 mm links, 0.38 mm hoch
 Streuwert: 2.06, horizontal: 1.98, vertikal: 2.13

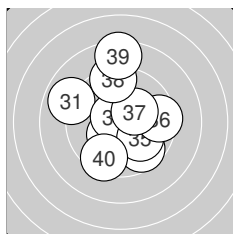

Serie 4:
 8.9 ↖ 9.7 ↘ 10.3 * 10.6 * 10.0 ↘
 9.5 → 10.3 * 9.3 ↑ 8.4 ↑ 9.5 ↙
 beste Teiler: 83.8 (34.), 155.3 (33.), 167.8 (37.)
 Trefferlage: 0.00 mm, 0.57 mm hoch
 Streuwert: 2.69, horizontal: 2.35, vertikal: 3.00



Ergebnis: **347.0** (328)
 Serien: 91.9 87.9 76.9 90.3
 Zähler: 4 16 12 4 1 2 1 0 0 0
 Innenzehner: 3
 Weitester: 1507 (11.), 1363 (21.), 1264 (22.)
 beste Teiler: 73.3 (3.), 101.5 (12.), 111.7 (20.)
 Trefferlage: 2.52 mm links, 2.71 mm hoch
 Streuwert: 3.85, horizontal: 4.76, vertikal: 2.63

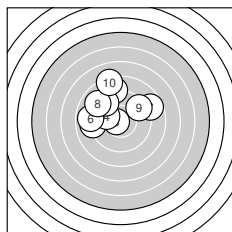
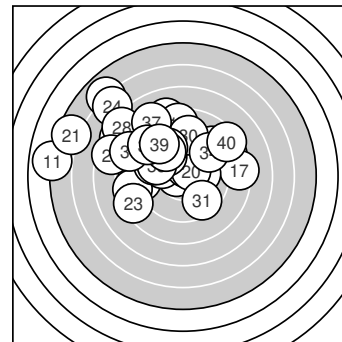

Serie 1:
 8.8 ↑ 9.0 ← 10.7 * 9.9 ↖ 9.3 ↘
 8.9 ← 8.7 ↗ 9.0 ↘ 9.4 ↗ 8.2 ↑
 beste Teiler: 73.3 (3.), 253.6 (4.), 391.2 (9.)
 Trefferlage: 1.42 mm links, 2.35 mm hoch
 Streuwert: 2.85, horizontal: 3.29, vertikal: 2.33

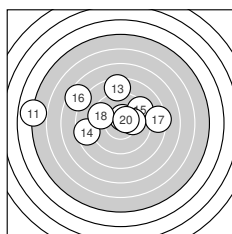

Serie 2:
 4.9 ← 10.5 * 8.5 ↑ 8.6 ← 9.3 ↗
 7.6 ↘ 8.4 → 9.5 ↖ 10.1 → 10.5 *
 beste Teiler: 101.5 (12.), 111.7 (20.), 208.8 (19.)
 Trefferlage: 1.88 mm links, 1.68 mm hoch
 Streuwert: 4.64, horizontal: 6.19, vertikal: 2.16

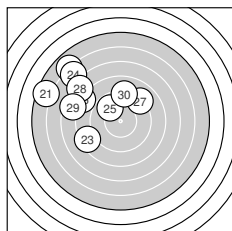

Serie 3:
 5.5 ↖ 5.9 ↘ 8.4 ← 6.4 ↘ 9.8 ↘
 7.9 ↘ 9.0 ↗ 7.4 ↘ 7.5 ↖ 9.1 ↑
 beste Teiler: 290.3 (25.), 472.0 (30.), 480.9 (27.)
 Trefferlage: 5.49 mm links, 4.08 mm hoch
 Streuwert: 4.16, horizontal: 4.83, vertikal: 3.36

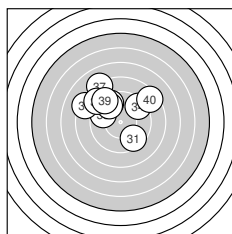

Serie 4:
 9.5 ↘ 9.5 ↘ 9.7 ↖ 9.3 ↗ 9.6 ↘
 8.3 ↖ 8.1 ↘ 8.8 ↘ 9.1 ↘ 8.4 ↗
 beste Teiler: 325.2 (33.), 340.8 (35.), 351.7 (31.)
 Trefferlage: 1.29 mm links, 2.74 mm hoch
 Streuwert: 2.97, horizontal: 3.53, vertikal: 2.29



Ergebnis: **372.4** (353)
Serien: 94.5 95.0 89.4 93.5
Zähler: 7 22 9 1 1 0 0 0 0 0
Innenzehner: 4
Weiteste: 1245 (28.), 980 (3.), 644 (35.)
beste Teiler: 123.0 (11.), 148.2 (8.), 177.0 (24.)
Trefferlage: 1.33 mm links, 0.51 mm tief
Streuwert: 3.16, horizontal: 3.02, vertikal: 3.29

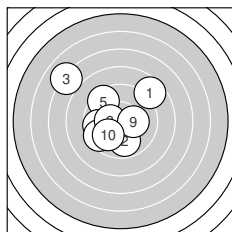
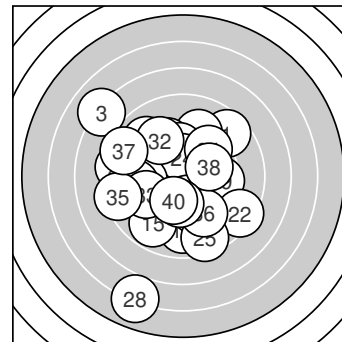

Serie 1:
 8.6 ↗ 9.8 ↓ 7.0 ↘ 9.9 ← 9.5 ↖
 9.7 ← 9.5 ↖ 10.4 * 10.2 * 9.9 ↗
beste Teiler: 148.2 (8.), 181.0 (9.), 260.0 (4.)
Trefferlage: 1.55 mm links, 0.51 mm hoch
Streuwert: 3.05, horizontal: 3.21, vertikal: 2.88

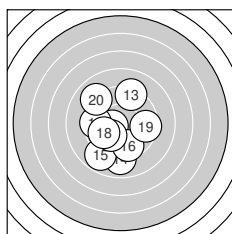

Serie 2:
 10.5 * 9.5 ← 9.2 ↑ 8.9 ↓ 8.8 ↖
 9.6 ↓ 10.1 ↗ 9.9 ↖ 9.5 → 9.0 ↘
beste Teiler: 123.0 (11.), 221.6 (17.), 272.7 (18.)
Trefferlage: 0.87 mm links, 0.90 mm tief
Streuwert: 2.69, horizontal: 2.36, vertikal: 2.99

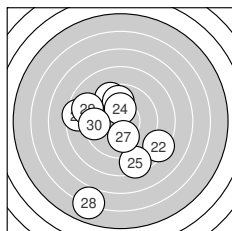

Serie 3:
 9.5 ↖ 8.4 ↘ 9.8 ↑ 10.2 * 8.5 ↓
 8.5 ← 10.1 ↓ 6.0 ↓ 8.9 ↖ 9.5 ←
beste Teiler: 177.0 (24.), 220.6 (27.), 282.9 (23.)
Trefferlage: 1.29 mm links, 1.30 mm tief
Streuwert: 4.12, horizontal: 3.53, vertikal: 4.64

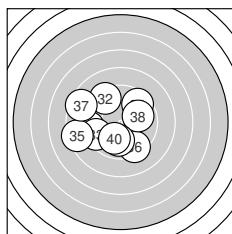

Serie 4:
 9.1 ← 9.3 ↖ 9.4 ↖ 9.6 ↗ 8.4 ←
 9.4 ↓ 8.5 ↖ 9.9 → 9.9 ↓ 10.0 ↓
beste Teiler: 246.2 (40.), 260.5 (39.), 262.8 (38.)
Trefferlage: 1.62 mm links, 0.35 mm tief
Streuwert: 2.90, horizontal: 3.28, vertikal: 2.46



Ergebnis: **382.7** (365)
 Serien: 97.9 95.0 93.0 96.8
 Zähler: 12 21 7 0 0 0 0 0 0 0
 Innenzehner: 10
 Weitester: 655 (23.), 646 (32.), 613 (15.)
 beste Teiler: 87.1 (22.), 110.3 (5.), 128.2 (31.)
 Trefferlage: 0.52 mm rechts, 0.29 mm hoch
 Streuwert: 2.69, horizontal: 2.70, vertikal: 2.68

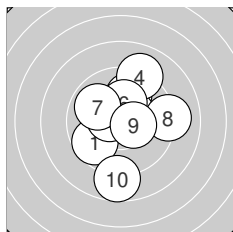
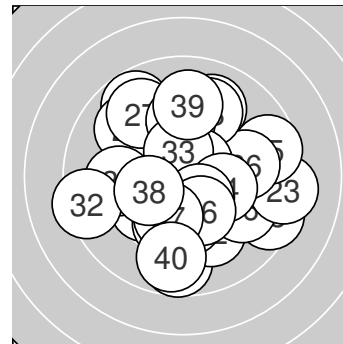

Serie 1:
 9.7 ↙ 9.9 ↑ 10.4 * 9.1 ↑ 10.5 *
 10.2 * 9.9 ↘ 9.1 → 10.4 * 8.7 ↓
 beste Teiler: 110.3 (5.), 128.4 (3.), 129.4 (9.)
 Trefferlage: 0.36 mm rechts, 0.34 mm hoch
 Streuwert: 2.40, horizontal: 2.08, vertikal: 2.68

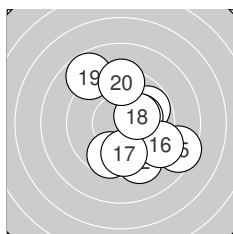

Serie 2:
 9.8 ↗ 9.3 ↓ 10.2 * 9.7 ↓ 8.5 ↘
 9.2 ↘ 9.8 ↓ 10.3 * 8.8 ↖ 9.4 ↑
 beste Teiler: 172.9 (18.), 194.8 (13.), 291.2 (11.)
 Trefferlage: 1.36 mm rechts, 0.29 mm tief
 Streuwert: 2.72, horizontal: 2.45, vertikal: 2.97

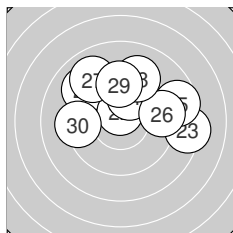

Serie 3:
 9.1 ↖ 10.6 * 8.3 → 10.0 ↑ 8.7 →
 9.3 → 9.0 ↖ 9.2 ↑ 9.5 ↑ 9.3 ←
 beste Teiler: 87.1 (22.), 250.0 (24.), 359.2 (29.)
 Trefferlage: 0.79 mm rechts, 1.93 mm hoch
 Streuwert: 2.90, horizontal: 3.68, vertikal: 1.79

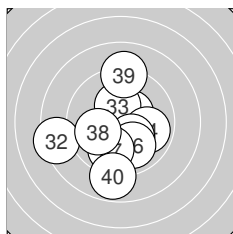

Serie 4:
 10.4 * 8.4 ← 10.3 * 9.9 → 10.2 *
 9.9 ↓ 9.8 ↓ 10.0 ← 9.1 ↑ 8.8 ↓
 beste Teiler: 128.2 (31.), 163.5 (33.), 179.8 (35.)
 Trefferlage: 0.43 mm links, 0.79 mm tief
 Streuwert: 2.55, horizontal: 2.43, vertikal: 2.67



Ergebnis: **397.0** (383)
 Serien: 100.7 95.8 99.7 100.8
 Zähler: 24 15 1 0 0 0 0 0 0 0
 Innenzehner: 16
 Weiteste: 680 (12.), 476 (21.), 460 (16.)
 beste Teiler: 42.2 (3.), 83.5 (23.), 93.8 (26.)
 Trefferlage: 0.28 mm links, 0.19 mm hoch
 Streuwert: 2.04, horizontal: 2.43, vertikal: 1.55

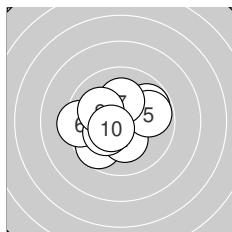
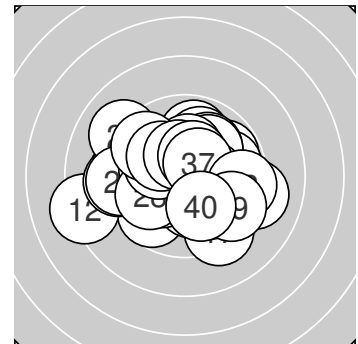

Serie 1:

9.7 ↙	9.8 ↗	10.8 *	10.2 *	9.8 →
9.4 ←	10.2 *	10.2 *	10.1 ↘	10.5 *

beste Teiler: 42.2 (3.), 114.2 (10.), 177.7 (4.)
 Trefferlage: 0.46 mm links, 0.05 mm tief
 Streuwert: 1.76, horizontal: 2.06, vertikal: 1.40

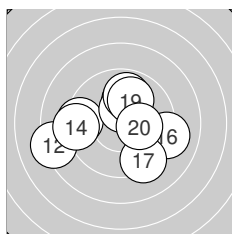

Serie 2:

10.1 ↑	8.2 ←	9.4 ←	9.2 ←	10.4 *
9.1 →	9.3 ↘	9.9 ↑	10.0 ↑	10.2 *

beste Teiler: 135.8 (15.), 184.4 (20.), 225.9 (11.)
 Trefferlage: 0.41 mm links, 0.12 mm hoch
 Streuwert: 2.80, horizontal: 3.39, vertikal: 2.03

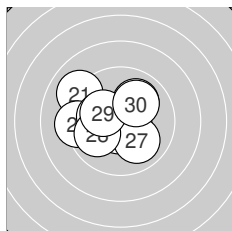

Serie 3:

9.0 ↘	9.3 ←	10.6 *	10.0 ↗	10.1 ←
10.6 *	10.0 ↘	9.9 ↙	10.2 *	10.0 ↗

beste Teiler: 83.5 (23.), 93.8 (26.), 185.7 (29.)
 Trefferlage: 0.89 mm links, 0.29 mm hoch
 Streuwert: 1.88, horizontal: 2.21, vertikal: 1.46

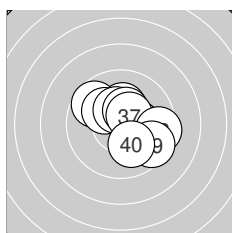

Serie 4:

10.2 *	10.3 *	9.7 ↘	10.2 *	10.4 *
10.4 *	10.5 *	9.5 →	9.5 ↘	10.1 ↘

beste Teiler: 119.5 (37.), 141.1 (36.), 143.2 (35.)
 Trefferlage: 0.63 mm rechts, 0.40 mm hoch
 Streuwert: 1.68, horizontal: 1.88, vertikal: 1.45



Ergebnis: **131.5** (121)
 Serien: 73.0 58.5
 Zähler: 0 1 5 3 4 3 2 1 0 1
 Innenzehner: 0
 Weitester: 2460 (19.), 1825 (18.), 1557 (20.)
 beste Teiler: 352.2 (1.), 545.7 (8.), 554.5 (4.)
 Trefferlage: 0.46 mm rechts, 1.23 mm hoch
 Streuwert: 8.65, horizontal: 9.23, vertikal: 8.02

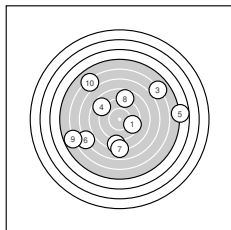
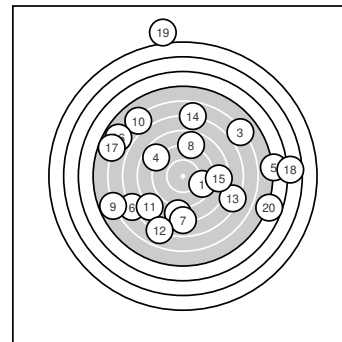

Serie 1:

9.5 ↘	8.4 ↓	6.0 ↗	8.7 ↖	4.8 →
6.9 ↙	8.0 ↓	8.8 ↑	5.8 ↙	6.1 ↖

beste Teiler: 352.2 (1.), 545.7 (8.), 554.5 (4.)
 Trefferlage: 0.36 mm links, 0.14 mm hoch
 Streuwert: 7.35, horizontal: 8.42, vertikal: 6.09

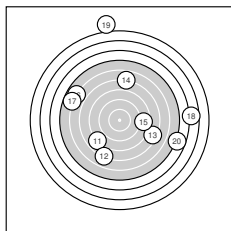

Serie 2:

7.9 ↙	7.0 ↓	7.3 ↘	6.8 ↑	8.5 →
5.8 ↖	5.7 ↖	3.7 →	1.1 ↑	4.7 ↘

beste Teiler: 610.1 (15.), 767.8 (11.), 923.4 (13.)
 Trefferlage: 1.29 mm rechts, 2.31 mm hoch
 Streuwert: 10.09, horizontal: 10.36, vertikal: 9.80



Ergebnis: **177.0** (168)
Serien: 90.6 86.4
Zähler: 2 9 5 3 1 0 0 0 0 0
Innenzehner: 1
Weiteste: 1002 (9.), 924 (20.), 833 (5.)
beste Teiler: 189.7 (10.), 250.7 (2.), 254.6 (19.)
Trefferlage: 0.98 mm links, 0.79 mm tief
Streuwert: 4.07, horizontal: 4.88, vertikal: 3.04

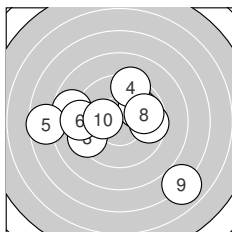
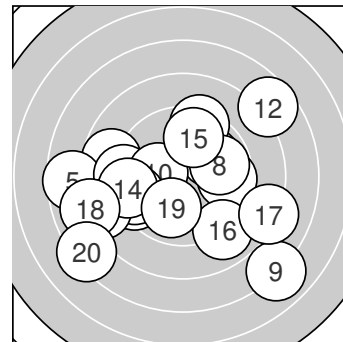

Serie 1:

8.7 ←	10.0 ↗	9.3 ←	9.3 ↑	7.6 ←
9.2 ←	9.6 →	9.8 →	6.9 ↘	10.2 *

beste Teiler: 189.7 (10.), 250.7 (2.), 288.7 (8.)
Trefferlage: 0.73 mm links, 0.16 mm tief
Streuwert: 3.93, horizontal: 4.76, vertikal: 2.87

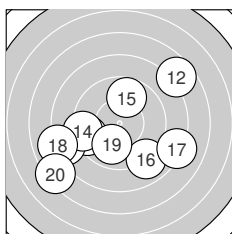

Serie 2:

9.4 ←	7.6 ↗	8.3 ←	9.2 ←	9.7 ↑
8.9 ↘	8.1 →	8.0 ←	9.9 ↓	7.3 ←

beste Teiler: 254.6 (19.), 301.5 (15.), 389.0 (11.)
Trefferlage: 1.24 mm links, 1.41 mm tief
Streuwert: 4.36, horizontal: 5.25, vertikal: 3.23



Ergebnis: **373.0** (354)
Serien: 96.1 89.3 93.5 94.1
Zähler: 9 21 5 5 0 0 0 0 0 0
Innenzehner: 7
Weiteste: 969 (17.), 902 (33.), 897 (39.)
beste Teiler: 47.8 (6.), 48.8 (3.), 69.2 (32.)
Trefferlage: 0.16 mm links, 0.80 mm tief
Streuwert: 3.33, horizontal: 3.44, vertikal: 3.21

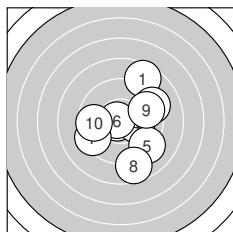
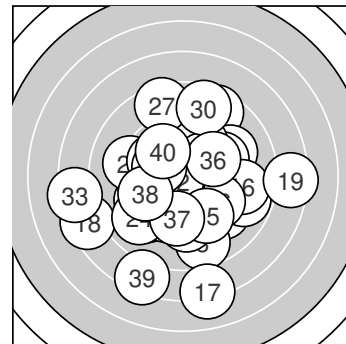

Serie 1:
 8.6 ↗ 9.2 ↘ 10.8 * 10.2 * 9.2 ↘
 10.8 * 9.4 ↙ 8.7 ↓ 9.6 → 9.6 ←
beste Teiler: 47.8 (6.), 48.8 (3.), 199.6 (4.)
Trefferlage: 0.90 mm rechts, 0.24 mm tief
Streuwert: 2.79, horizontal: 2.68, vertikal: 2.89

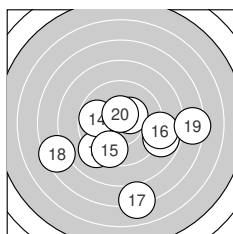

Serie 2:
 8.8 → 10.4 * 9.2 ↙ 9.8 ← 9.6 ↘
 9.0 → 7.1 ↓ 7.5 ↙ 7.4 → 10.5 *
beste Teiler: 113.1 (20.), 147.5 (12.), 296.1 (14.)
Trefferlage: 0.67 mm rechts, 2.00 mm tief
Streuwert: 4.08, horizontal: 4.81, vertikal: 3.19

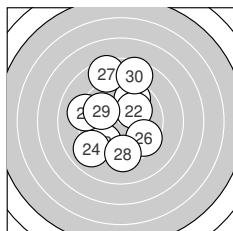

Serie 3:
 9.7 ↗ 10.1 ↗ 9.6 ↙ 9.0 ↙ 9.2 ←
 9.5 ↘ 8.5 ↖ 9.4 ↓ 9.9 ↖ 8.6 ↗
beste Teiler: 212.5 (22.), 266.5 (29.), 310.8 (21.)
Trefferlage: 0.62 mm links, 0.58 mm hoch
Streuwert: 3.07, horizontal: 2.52, vertikal: 3.53

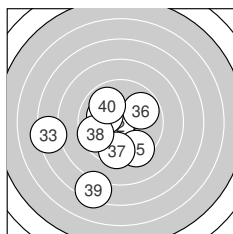

Serie 4:
 10.4 * 10.7 * 7.3 ← 10.1 ↖ 9.4 ↘
 9.8 ↗ 9.5 ↓ 9.6 ↙ 7.4 ↓ 9.9 ↖
beste Teiler: 69.2 (32.), 144.8 (31.), 209.2 (34.)
Trefferlage: 1.60 mm links, 1.56 mm tief
Streuwert: 3.09, horizontal: 3.19, vertikal: 3.00



Ergebnis: **385.6** (364)
 Serien: 93.3 94.1 99.5 98.7
 Zähler: 14 17 8 1 0 0 0 0 0 0
 Innenzehner: 12
 Weitesten: 755 (15.), 716 (12.), 655 (6.)
 beste Teiler: 46.3 (11.), 69.2 (32.), 75.5 (21.)
 Trefferlage: 0.46 mm rechts, 0.48 mm hoch
 Streuwert: 2.66, horizontal: 3.38, vertikal: 1.65

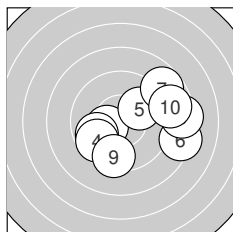
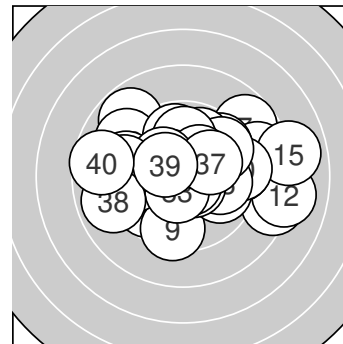

Serie 1:
 9.8 ↙ 10.3 * 9.8 ↙ 9.7 ↙ 10.0 ↗
 8.3 → 8.7 ↗ 8.4 → 9.5 ↓ 8.8 →
 beste Teiler: 155.2 (2.), 238.5 (5.), 281.2 (1.)
 Trefferlage: 1.47 mm rechts, 0.42 mm tief
 Streuwert: 3.06, horizontal: 3.78, vertikal: 2.11

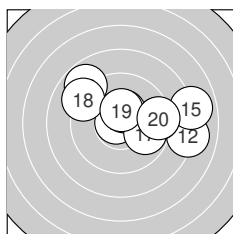

Serie 2:
 10.8 * 8.1 → 8.8 ↘ 10.4 * 7.9 →
 9.4 → 9.8 → 9.1 ↘ 10.4 * 9.4 →
 beste Teiler: 46.3 (11.), 129.4 (14.), 137.2 (19.)
 Trefferlage: 1.73 mm rechts, 0.93 mm hoch
 Streuwert: 3.01, horizontal: 3.96, vertikal: 1.56

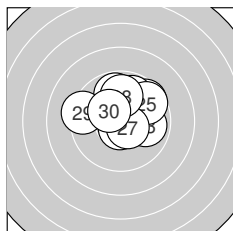

Serie 3:
 10.7 * 9.6 ↗ 9.9 → 9.8 ↗ 9.6 ↗
 9.8 ↑ 10.6 * 9.9 ↑ 9.3 ← 10.3 *
 beste Teiler: 75.5 (21.), 97.8 (27.), 161.4 (30.)
 Trefferlage: 0.40 mm rechts, 1.21 mm hoch
 Streuwert: 1.77, horizontal: 2.07, vertikal: 1.40

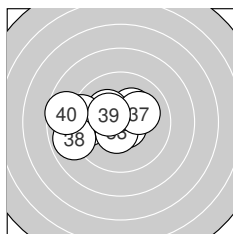

Serie 4:
 9.6 ← 10.7 * 10.5 * 10.3 * 10.2 *
 9.3 ← 10.1 ↗ 8.9 ← 10.4 * 8.7 ←
 beste Teiler: 69.2 (32.), 109.9 (33.), 147.0 (39.)
 Trefferlage: 1.76 mm links, 0.23 mm hoch
 Streuwert: 2.00, horizontal: 2.64, vertikal: 1.04



Ergebnis: **387.7** (369)
 Serien: 101.0 97.4 94.3 95.0
 Zähler: 13 23 4 0 0 0 0 0 0 0
 Innenzehner: 9
 Weitestе: 606 (12.), 594 (30.), 559 (31.)
 beste Teiler: 44.3 (1.), 81.7 (19.), 117.9 (16.)
 Trefferlage: 0.20 mm rechts, 0.28 mm hoch
 Streuwert: 2.44, horizontal: 2.84, vertikal: 1.97

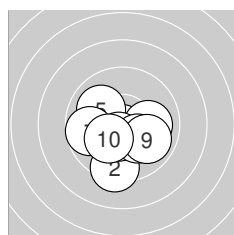
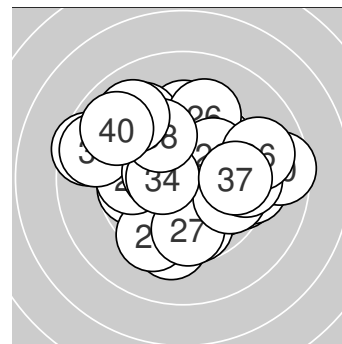

Serie 1:
 10.8 * 9.3 ↓ 10.0 → 10.4 * 10.0 ↖
 10.5 * 9.7 ← 10.2 * 9.9 ↘ 10.2 *
 beste Teiler: 44.3 (1.), 119.2 (6.), 150.8 (4.)
 Trefferlage: 0.26 mm links, 0.98 mm tief
 Streuwert: 1.56, horizontal: 1.77, vertikal: 1.33

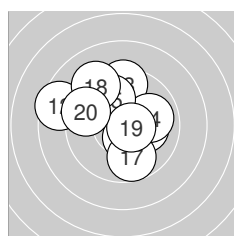

Serie 2:
 10.1 → 8.5 ← 9.5 ↑ 9.9 → 9.9 ↖
 10.5 * 9.7 ↓ 9.2 ↘ 10.6 * 9.5 ←
 beste Teiler: 81.7 (19.), 117.9 (16.), 201.9 (11.)
 Trefferlage: 0.61 mm links, 0.89 mm hoch
 Streuwert: 2.35, horizontal: 2.58, vertikal: 2.10

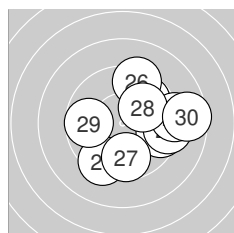

Serie 3:
 9.4 ↙ 9.5 → 9.3 → 9.8 ↗ 9.0 →
 9.3 ↗ 9.7 ↓ 10.0 ↗ 9.7 ← 8.6 →
 beste Teiler: 234.4 (28.), 296.9 (24.), 310.0 (29.)
 Trefferlage: 1.89 mm rechts, 0.04 mm hoch
 Streuwert: 2.56, horizontal: 2.86, vertikal: 2.22

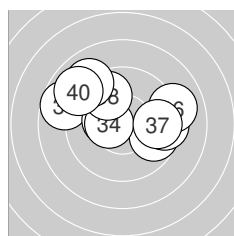

Serie 4:
 8.7 ← 9.7 → 10.3 * 10.5 * 9.4 →
 9.0 → 9.7 → 9.8 ↘ 9.0 ↘ 8.9 ↘
 beste Teiler: 124.0 (34.), 153.0 (33.), 295.2 (38.)
 Trefferlage: 0.20 mm links, 1.17 mm hoch
 Streuwert: 2.76, horizontal: 3.55, vertikal: 1.60

